



Agilent X-Series Signal Analyzer

**This manual provides documentation for the
following X-Series Analyzers:
MXA Signal Analyzer N9020A
EXA Signal Analyzer N9010A**

**N9079A TD-SCDMA with
HSPA/8PSK Measurement
Application User's and
Programmer's Reference**



Agilent Technologies

Notices

© Agilent Technologies, Inc. 2008

No part of this manual may be reproduced in any form or by any means (including electronic storage and retrieval or translation into a foreign language) without prior agreement and written consent from Agilent Technologies, Inc. as governed by United States and international copyright laws.

Trademark Acknowledgements

Microsoft® is a U.S. registered trademark of Microsoft Corporation.

Windows® and MS Windows® are U.S. registered trademarks of Microsoft Corporation.

Adobe Reader® is a U.S. registered trademark of Adobe System Incorporated.

Java™ is a U.S. trademark of Sun Microsystems, Inc.

MATLAB® is a U.S. registered trademark of Math Works, Inc.

Norton Ghost™ is a U.S. trademark of Symantec Corporation.

Manual Part Number

N9079-90007
Supersedes N9079-90004

Print Date

February 2009
Printed in USA

Agilent Technologies, Inc.
1400 Fountaingrove Parkway
Santa Rosa, CA 95403

Warranty

The material contained in this document is provided “as is,” and is subject to being changed, without notice, in future editions. Further, to the maximum extent permitted by applicable law, Agilent disclaims all warranties, either express or implied, with regard to this manual and any information contained herein, including but not limited to the implied warranties of merchantability and fitness for a particular purpose. Agilent shall not be liable for errors or for incidental or consequential damages in connection with the furnishing, use, or performance of this document or of any information contained herein. Should Agilent and the user have a separate written agreement with warranty terms covering the material in this document that conflict with these terms, the warranty terms in the separate agreement shall control.

Technology Licenses

The hardware and/or software described in this document are furnished under a license and may be used or copied only in accordance with the terms of such license.

Restricted Rights Legend

If software is for use in the performance of a U.S. Government prime contract or subcontract, Software is delivered and

licensed as “Commercial computer software” as defined in DFAR 252.227-7014 (June 1995), or as a “commercial item” as defined in FAR 2.101(a) or as “Restricted computer software” as defined in FAR 52.227-19 (June 1987) or any equivalent agency regulation or contract clause. Use, duplication or disclosure of Software is subject to Agilent Technologies’ standard commercial license terms, and non-DOD Departments and Agencies of the U.S. Government will receive no greater than Restricted Rights as defined in FAR 52.227-19(c)(1-2) (June 1987). U.S. Government users will receive no greater than Limited Rights as defined in FAR 52.227-14 (June 1987) or DFAR 252.227-7015 (b)(2) (November 1995), as applicable in any technical data.

Safety Notices

CAUTION

A CAUTION notice denotes a hazard. It calls attention to an operating procedure, practice, or the like that, if not correctly performed or adhered to, could result in damage to the product or loss of important data. Do not proceed beyond a CAUTION notice until the indicated conditions are fully understood and met.

WARNING

A WARNING notice denotes a hazard. It calls attention to an operating procedure, practice, or the like that, if not correctly performed or adhered to, could result in personal injury or death. Do not proceed beyond a WARNING notice until the indicated conditions are fully understood and met.

Warranty

This Agilent technologies instrument product is warranted against defects in material and workmanship for a period of one year from the date of shipment. During the warranty period, Agilent Technologies will, at its option, either repair or replace products that prove to be defective.

For warranty service or repair, this product must be returned to a service facility designated by Agilent Technologies. Buyer shall prepay shipping charges to Agilent Technologies and Agilent Technologies shall pay shipping charges to return the product to Buyer. However, Buyer shall pay all shipping charges, duties, and taxes for products returned to Agilent Technologies from another country.

Where to Find the Latest Information

Documentation is updated periodically. For the latest information about this analyzer, including firmware upgrades, application information, and product information, see the following URLs:

<http://www.agilent.com/find/mxa>

<http://www.agilent.com/find/exa>

To receive the latest updates by email, subscribe to Agilent Email Updates:

<http://www.agilent.com/find/emailupdates>

Information on preventing analyzer damage can be found at:

<http://www.agilent.com/find/tips>

1. Using Help

Locating Other Help Resources	94
Viewing Help on a separate Computer	95
Copying the HTML Help (CHM) Files	95
Copying the Acrobat (PDF) Files	96
How Help is Organized.	98
Help Contents Listing	98
System Functions	98
Key Descriptions for Each Measurement	99
Key Information for Softkeys	99
Common Measurement Functions	100
Front Panel Keys used by the Help System	101
Navigating Windows HTML Help (CHM) Files	102
HTML Help Window Components.	102
Basic Help Window Operations	103
Navigating the Help Window	104
Navigating Acrobat (PDF) Files	110
Adobe Reader Window	110
Printing Acrobat Files	111
Terms Used in This Documentation	113
Terms used in Key Parameter Tables	113
Context Sensitive Help not Available.	115
Finding a Topic without a Mouse and Keyboard	115
Selecting a Hyperlink without a Mouse	116

2. About the Analyzer

Installing Application Software	118
Viewing a License Key	118
Obtaining and Installing a License Key	118
Missing and Old Measurement Application Software	119
X-Series Options and Accessories	119
Front-Panel Features	122
Overview of key types.	125
Display Annotations	126
Rear-Panel Features	128
Window Control Keys	130
Multi-Window	130
Zoom	130
Next Window	131
Mouse and Keyboard Control.	133
Right-Click	133
PC Keyboard.	135

3. About TD-SCDMA with HSPA/8PSK Measurement Application

Installing Application Software	140
Viewing a License Key	140
Obtaining and Installing a License Key	140
Missing and Old Measurement Application Software	141

4. Programming the Analyzer

What Programming Information is Available?	144
STATus Subsystem (No equivalent front-panel keys)	145
Detailed Description	147
STATus Subsystem Command Descriptions.	157
IEEE Common GPIB Commands	187
Calibration Query	187
Clear Status	187
Standard Event Status Enable	187
Standard Event Status Register Query	188
Identification Query	188
Operation Complete	189
Query Instrument Options	189
Recall Instrument State	190
Save Instrument State	190
Service Request Enable	191
Status Byte Query	191
Trigger	192
Self Test Query	192
Wait-to-Continue	192

5. System Functions

File	194
File Explorer	194
Page Setup	194
Print.	194
Exit	194
Preset	196
Mode Preset	196
Restore Mode Defaults	197
*RST (Remote Command Only)	198
Print	199
Quick Save	200
Recall	202
Save	203
System	204
Show	204
Power On	212
Configure Applications.	214
Alignments	218
I/O Config	241
Restore Defaults	278
Control Panel...	282
Licensing.....	283
Agilent Upgrade Service.	285
Service	286
Diagnostics	286
List installed Options (Remote Command Only)	289
Lock the Front-panel keys (Remote Command Only)	290

List SCPI Commands (Remote Command Only)	290
SCPI Version Query (Remote Command Only)	290
Date (Remote Command Only)	291
Time (Remote Command Only)	291
User Preset	292
User Preset	292
User Preset All Modes	293
Save User Preset	294

6. Burst Power (Transmit Power)

AMPTD Y Scale	298
Y Ref Value	298
Attenuation	298
Scale/Division	299
Presel Center (Measurement Global)	299
Presel Adjust (Measurement Global)	299
Internal Preamp	299
Ref Position	300
Auto Scaling	300
Auto Couple	302
BW	303
Res BW	303
RBW Control	303
Cont (Continuous)	305
FREQ/Channel (Frequency or Channel)	306
Input/Output	307
Marker	308
Select Marker	308
Marker Type	308
Marker X Axis Value	309
Marker X Axis Position (Remote Command Only)	309
Marker Y Axis Value (Remote Command Only)	310
Properties	311
Couple Markers	312
All Markers Off	313
Marker Function	314
Marker To	315
Meas	316
Meas Setup	317
Avg/Hold Num	317
Avg Mode	318
Avg Type	318
Threshold Lvl	319
Meas Method	321
Burst Width	322
IF Gain	323
Meas Interval (for TD-SCDMA mode)	325
Meas Preset	325
Mode	327

Mode Setup	328
Peak Search	329
Recall	330
Restart	331
Save	332
Single	333
Source	334
SPAN X Scale	335
Ref Value	335
Scale/Div	335
Ref Position	336
Auto Scaling	337
Sweep/Control	338
Sweep Time (for SAmode)	338
Sweep Time (for GSM mode)	338
Pause/Resume	339
Trace/Detector	340
Max Hold Trace	340
Min Hold Trace	340
Trigger	342
View/Display	343
RF Envelope window	345
Metrics window	345
Display	347
Bar Graph	347

7. ACP Measurement

AMPTD Y Scale	356
Ref Value	356
Attenuation	356
Scale/Div	357
Presel Center	357
Presel Adjust	357
Internal Preamp	358
Ref Position	358
Auto Scaling	358
Auto Couple	360
BW	361
Res BW	361
Video BW	362
RBW Control	363
Cont	365
FREQ Channel	366
Input/Output	367
Marker	368
Select Marker	368
Marker Type	368
Marker X Axis Value (Remote Command only)	369
Marker X Axis Position (Remote Command only)	370

Contents

Marker Y Axis Value (Remote Command only)	370
Properties	371
Couple Markers	373
Marker All Off	373
Marker Function	374
Marker To	375
Meas	376
Meas Setup	377
Average/Hold Number	377
Avg Mode	377
Carrier Setup	378
Offset/Limits	388
Carrier Result	400
PhNoise Opt	400
Meas Method	402
Meas Type	403
Limit Test	404
Offset RRC Weighting	405
Offset Filter Alpha	406
Meas Preset	407
Noise Correction	407
Mode	408
Mode Setup	409
Peak Search	410
Peak Search	410
Next Peak	410
Next Pk Right	410
Next Pk Left	411
Marker Delta	411
Pk-Pk Search	411
Min Search	412
Recall	413
Restart	414
Save	415
Single	416
Source	417
SPAN X Scale	418
Span	418
Full Span	419
Last Span	419
Sweep/Control	420
Sweep Time	420
Sweep Setup	421
Pause	422
Gate	422
Points	423
Trace/Detector	424
Trace Type	424
Detector	425

Select Trace (frontpanel only).....	427
View / Blank	427
Trigger	429
View/Display	430
Display	434
Bar Graph	434

8. Power vs Time Measurement

Amplitude (AMPTD) Y Scale	442
Ref Value.	442
Attenuation	442
Scale/Div.	443
Presel Center.....	443
Presel Adjust.....	443
Internal Preamp.....	443
Ref Position.....	444
Auto Scale.....	444
Auto Couple	445
BW	446
Cont	447
FREQ Channel	448
Input/Output	449
Marker	450
Select Marker	450
Marker Type	450
Marker X Axis Value	451
Marker X Axis Position (Remote Command only)	452
Marker Y Axis Value (Remote Command only)	452
Properties	453
Couple Marker	454
All Markers Off.....	455
Maker State (Remote Command Only)	455
Marker Fctn	457
Marker To.....	458
Meas	459
Meas Setup	460
Avg/Hold Num	460
Avg Mode	461
Avg Type.....	461
Meas Interval	462
IF Gain	462
Meas Preset.....	464
Limit Mask Selection (Remote Command only)	464
Lower Mask Absolute Amplitude Levels (Remote Command only).....	465
Lower Mask Points (Remote Command only).....	466
Lower Mask Relative Amplitude Levels (Remote Command only)	467
Lower Mask Time Points (Remote Command only)	467
Upper Mask Absolute Amplitude Levels (Remote Command only)	468
Upper Mask Points (Remote Command only)	469

Contents

Upper Mask Relative Amplitude Levels (Remote Command only)	470
Upper Mask Time Points (Remote Command only)	470
Mode	472
Mode Setup	473
Peak Search	474
Recall	475
Restart	476
Save	477
Single	478
Source	479
SPAN X Scale	480
Ref Value	480
Scale/Div	481
Ref Position	481
Auto Scale	482
Sweep/Control	483
Abort (Remote Command Only)	483
Pause and Resume	483
Trace/Detector	484
Max Hold Trace	484
Min Hold Trace	484
Trigger	486
Trigger Source	486
Auto Trig	486
Trig Holdoff	486
View/Display	487
Display	489
Trigger Lines	489
Burst Lines	490
Ramp Lines	490
Limit Mask	491
Scroll	491

9. Spectrum Emission Mask Measurement

AMPTD Y Scale	504
Ref Value	504
Attenuation	505
Scale/Div	505
Presel Center	505
Presel Adjust	506
Internal Preamp	506
Ref Position	506
Auto Scaling	506
Auto Couple	508
BW	509
Cont.	510
FREQ Channel	511
Input/Output	512
Marker	513

Contents

Select Marker	513
Marker Type	513
Marker X Axis Value (Remote Command only)	514
Marker X Axis Position (Remote Command only)	514
Marker Y Axis Value (Remote Command only)	515
Couple Markers	516
All Markers Off	516
Marker Function	517
Marker To	518
Meas	519
Meas Setup	520
Avg/Hold Num	520
Meas Type	521
Ref Channel	521
Power Ref	527
Offsets/Limits	530
Method	548
Filter Alpha	548
Meas Preset	549
Limits State	549
Limits Type (Only for DVB-T/H)	550
Mode	552
Mode Setup	553
Peak Search	554
Recall	555
Restart	556
Save	557
Single	558
Source	559
Span X Scale	560
Sweep/Control	561
Pause	561
Gate	561
Trace/Detector	562
Trace Type	562
Chan Detector	562
Offset Detector	564
Trigger	567
View/Display	568
Display	569
Abs Pwr Freq	569
Rel Pwr Freq	575
Integrated Power	581
Limit Lines	587
10. Spurious Emissions Measurement	
AMPTD Y Scale	591
Ref Value	591
Attenuation	592

Contents

Scale/Div	592
Presel Center	592
Presel Adjust	593
Internal Preamplifier	593
Auto Scaling	593
Auto Couple	595
BW	596
Cont.	597
Frequency/Channel	598
Input/Output	599
Marker	600
Select Marker	600
Marker Type	600
Marker X Axis Value (Remote Command only)	601
Marker X Axis Position (Remote Command only)	602
Marker Y Axis Value (Remote Command only)	602
Properties	603
Couple Markers	604
All Markers Off	604
Marker Function	605
Marker To	606
Meas	607
Meas Setup	608
Avg/Hold Num	608
Avg Mode	608
Range Table	609
Meas Type	627
Spur	628
Spurious Report Mode	629
Meas Preset	630
Range Preset (for TD-SCDMA only)	630
CH Mean Power (for DVB-T/H only)	636
Mode	639
Mode Setup	640
Peak Search	641
Peak Search	641
Next Peak	641
Next Pk Right	641
Next Pk Left	642
Marker Delta	642
Pk-Pk Search	642
Min Search	643
Recall	644
Restart	645
Save	646
Single	647
Source	648
Span X Scale	649
Sweep/Control	650

Sweep Setup	650
Pause	651
Trace/Detector	652
Trigger	653
View/Display	654
Standard Result Screen	654
Display	655

11. Occupied Bandwidth Measurement

Measurement Results	659
Occupied Bandwidth	659
Total Power	659
Transmit Freq Error	659
x dB Bandwidth	659
AMPTD Y Scale (Amplitude/Y Scale)	660
Ref Value	660
Attenuation	660
Scale/Div	661
Presel Center	661
Presel Adjust	662
Internal Preamp	662
Ref Position	662
Auto Scaling	663
Auto Couple	664
BW	665
Res BW	665
Video BW	666
Filter Type	667
Cont (Continuous)	669
FREQ/Channel (Frequency or Channel)	670
Input/Output	671
Marker	672
Select Marker	672
Marker X Axis Value (Remote Command only)	672
Marker X Axis Position (Remote Command only)	673
Marker Y Axis Value (Remote Command only)	673
Marker Type	673
Properties	674
All Markers Off	675
Marker Function	676
Marker To	677
Meas	678
Meas Setup	679
Avg/Hold Num	679
Avg Mode	680
Max Hold (Remote Command Only)	680
Occ BW % Pwr	681
x dB	681
IF Gain	682

Limit	683
Meas Preset	684
Mode	685
Mode Setup	686
Peak Search	687
Recall	688
Restart	689
Save	690
Single	691
Source	692
Span X Scale	693
Span	693
Full Span	694
Last Span	694
Sweep/Control	695
Sweep Time	695
Sweep Setup	696
Pause	697
Gate	697
Points	697
Trace/Detector	699
Trace Type	699
Detector	699
Trigger	702
View/Display	703
Display	705

12. Power Stat CCDF Measurement

AMPTD Y Scale	710
Attenuation	710
Range	710
Presel Center	710
Presel Adjust	711
Internal Preamp	711
Auto Couple	712
BW	713
Info BW	713
Cont.	714
FREQ Channel	715
Input/Output	716
Marker	717
Select Marker	717
Marker Type	717
Marker X Axis Value	718
Marker Y Axis Value	719
Properties	719
Couple Markers	720
All Markers Off	721
Marker To	722

Contents

Marker Function	723
Meas	724
Meas Setup	725
Counts	725
Meas Cycles	725
Meas Interval (When the application is NOT CDMA1xEVDO)	726
Meas Interval (CDMA1xEVDO Only)	727
Meas Offset (CDMA1xEVDO Only)	727
IF Gain	728
Meas Preset	729
Mode	731
Mode Setup	732
Peak Search	733
Recall	734
Restart	735
Save	736
Single	737
Source	738
Span X Scale	739
Scale/Div	739
Sweep/Control	740
Pause/Resume	740
Trace/Detector	741
Store Ref Trace	741
Ref Trace	741
Gaussian Line	742
Trigger	743
View/Display	744
Display	747
Slot View (TD-SCDMA only)	747

13. Code Domain Measurement

Amplitude (AMPTD) Y Scale	756
Ref Value	756
Attenuation	761
Range	761
Scale/Div	761
Presel Center	766
Presel Adjust	766
Internal Preamp	766
Ref Position	766
Auto Scale	770
Auto Couple	775
BW	776
Cont	777
FREQ Channel	778
Center Freq	778
CF Step	778
Carrier Config	778

Contents

Input/Output	779
Marker.	780
Select Marker	780
Marker Type	780
Marker Symbol Value	781
Marker X Axis Value (Remote Command only).	782
Marker X Axis Position (Remote Command only).	782
Marker Y Axis Value (Remote Command only).	783
Properties.	783
Couple Marker.	785
All Markers Off.	785
Backward Compatibility SCPI Commands.	786
Marker Fctn.	787
Marker To	788
Meas	789
Meas Setup	790
Result Length	790
Analysis Subframe	790
Spread Code Length	791
Code Channel	792
Meas Preset	792
Mode	793
Mode Setup	794
Peak Search.	795
Peak Search	795
Next Peak	795
Next Pk Right	795
Next Pk Left	796
Marker Delta	796
Pk-Pk Search	796
Min Search	796
Recall	798
Restart.	799
Save.	800
Single	801
Source	802
SPAN X Scale.	803
Ref Value.	803
Scale/Div	807
Ref Position.	812
Auto Scale.	815
Sweep/Control	819
Abort (Remote Command Only).	819
Pause and Resume.	819
Trace/Detector.	820
Trigger.	821
Trigger Source.	821
Auto Trig	823
Trig Holdoff.	823

View/Display	824
Display	824
View Selection by Name	824
View Selection by Number (Remote Command only)	826
View Settings	827

14. Modulation Accuracy (Composite EVM) Measurement

Amplitude (AMPTD) Y Scale	845
Ref Value	845
Attenuation	848
Range	849
Scale/Div	849
Presel Center	852
Presel Adjust	852
Internal Preamp	852
Ref Position	853
Auto Scale	855
Auto Couple	860
BW	861
Cont	862
FREQ Channel	863
Center Freq	863
CF Step	863
Carrier Config	863
Input/Output	865
Marker	866
Select Marker	866
Marker Type	866
Marker Chip Value	867
Marker X Axis Value (Remote Command only)	868
Marker X Axis Position (Remote Command only)	868
Marker Y Axis Value (Remote Command only)	869
Properties	869
Couple Marker	871
All Markers Off	871
Backward Compatibility SCPI Commands	871
Marker Fctn	873
Marker To	874
Meas	875
Meas Setup	876
Avg/Hold Num	876
Avg Mode	876
Result Length	877
Analysis Subframe	878
Limits	878
Meas Preset	882
Mode	883
Mode Setup	884
Peak Search	885

Peak Search	885
Next Peak	885
Next Pk Right	885
Next Pk Left	886
Marker Delta	886
Pk-Pk Search	886
Min Search	886
Source	888
SPAN X Scale	889
Ref Value	889
Scale/Div	892
Ref Position	896
Auto Scale	899
Sweep/Control	902
Abort (Remote Command Only)	902
Pause and Resume	902
Record Data Now	902
Playback (Recorded Data)	902
Trace/Detector	903
Trigger	904
Trigger Source	904
Auto Trig	905
Trig Holdoff	906
View/Display	907
Display	922
View Selection	922
View Selection by number (Remote Command only)	923
View Settings	924

15. Waveform Measurement

AMPTD Y Scale	933
Ref Value	933
Attenuation	934
Range	934
Scale/Div	935
Presel Center	936
Presel Adjust	936
Internal Preamp	937
Ref Position	937
Auto Scaling	938
Auto Couple	940
BW	941
Info BW	941
IBW Control	942
Cont.	951
FREQ Channel	952
Input/Output	953
Marker	954
Select Marker	954

Marker Type	954
Marker X Axis Value (Remote Command only)	955
Marker X Axis Position (Remote Command only)	956
Marker Y Axis Value (Remote Command only)	957
Properties	957
Couple Markers.	959
All Markers Off.	959
Marker Function	960
Select Marker	960
Marker Function Type.	960
Band Adjust	961
Marker To.	964
Meas	965
Meas Setup	966
Average/Hold Number	966
Avg Mode	966
Avg Type.	967
Meas Time.	968
Meas Preset.	968
Advanced	968
Mode.	972
Mode Setup.	973
Peak Search	974
Next Peak	974
Min Search	974
Recall	976
Restart.	977
Save	978
Single	979
Source.	980
Span X Scale.	981
Ref Value.	981
Scale/Div.	981
Ref Position	982
Auto Scaling	983
Sweep/Control	984
Pause and Resume	984
Trace/Detector	985
Trigger	986
View/Display	987
Display	988
RF Envelop	988
I/Q Waveform	990
16. Monitor Spectrum Measurement	
AMPTD Y Scale.	992
Ref Value.	992
Attenuation	992
Scale/Div.	993

Contents

Presel Center	993
Presel Adjust	993
Internal Preamp	993
Ref Position	994
Auto Scaling	994
Auto Couple	996
BW	997
Res BW	997
Video BW	998
VBW:3dB RBW	998
Span:3dB RBW	999
Cont.	1001
FREQ Channel	1002
Input/Output	1003
Marker	1004
Select Marker	1004
Marker Type	1004
Properties	1006
Select Marker	1006
Couple Markers	1008
All Markers Off	1008
Marker Function	1009
Select Marker	1009
Marker Function Type	1009
Band Adjust	1009
Marker To	1012
Meas	1013
Meas Setup	1014
Avg/Hold Num	1014
Avg Mode	1014
Meas Preset	1015
Mode	1016
Mode Setup	1017
Peak Search	1018
Recall	1019
Restart	1020
Save	1021
Single	1022
Source	1023
Span X Scale	1024
Span	1024
Full Span	1025
Last Span	1025
Sweep/Control	1026
Sweep Time	1026
Pause	1026
Gate	1027
Points	1027
Trace/Detector	1028

Select Trace	1028
Trace Type	1028
Update	1029
Display	1029
Detector	1030
Clear Trace	1032
Clear All Traces	1032
View/Display	1033
Display	1034

17. Common Measurement Functions

Amplitude Y Scale (AMPTD Y Scale)	1037
Attenuation	1037
Range	1043
Presel Center	1049
Preselector Adjust	1050
Internal Preamp	1052
AUTO COUPLE	1055
BW	1057
Cont (Continuous Measurement/Sweep)	1059
Frequency/Channel	1061
Center Freq	1061
CF Step	1063
Input/Output	1065
RF Input	1066
I/Q	1067
RF Calibrator	1082
External Gain	1083
Restore Input/Output Defaults	1087
Data Source	1087
Corrections	1092
Freq Ref In	1101
Output Config	1105
I/Q Guided Calibration	1109
Marker Function	1121
Marker	1123
Marker To	1125
Meas	1127
Remote Measurement Functions	1127
Meas Setup	1143
Mode	1145
Application Mode Number Selection (Remote Command only)	1146
Application Mode Catalog Query (Remote Command only)	1147
Application Identification (Remote Commands only)	1147
Application Identification Catalog (Remote Commands only)	1149
Detailed List of Modes	1150
Mode Setup	1159
Radio	1159
Analysis Timeslot	1159

Contents

HSPA/8PSK Enable	1161
Restore Mode Defaults	1162
Demod.	1162
Peak Search.	1177
Recall	1179
State.	1179
Trace (+State)	1183
Data (Mode Specific)	1187
File Open Dialog and Menu	1197
Restart.	1201
Save.	1203
State.	1203
Trace (+State)	1206
Data (Mode Specific)	1210
Screen Image.	1221
Save As	1225
Single (Single Measurement/Sweep)	1229
Source	1231
SPAN X Scale	1233
Sweep / Control	1235
Abort (Remote Command Only)	1235
Pause/Resume	1236
Gate	1236
Trace / Detector.	1251
Trigger.	1253
Free Run	1261
Video (IF Envelope)	1261
Line	1263
External 1	1265
External 2	1267
RF Burst (Wideband)	1269
Periodic Timer (Frame Trigger)	1271
LXI Trigger	1278
Baseband I/Q.	1294
Auto/Holdoff.	1304
Trigger Offset (Remote Command Only)	1306
View/Display	1307
Display	1307
Full Screen.	1315
Display Enable (Remote Command Only)	1316

List of Commands

*CAL?	225
*CLS	187
*ESE <integer>	187
*ESE?	187
*ESR?	188
*IDN?	189
*OPC?	189
*OPC	189
*OPT?	190
*RCL <register #>	190
*RST	198
*SAV <register #>	190
*SRE <integer>	191
*SRE?	191
*STB?	191
*TRG	192
*TST?	192
*WAI	192
:ABORt	1235
:CALCulate:ACPower:LIMit:STATe OFF ON 0 1	405
:CALCulate:ACPower:LIMit:STATe?	405
:CALCulate:ACPower:MARKer:AOff	373
:CALCulate:ACPower:MARKer:COUPle[:STATe] ON OFF 1 0	373
:CALCulate:ACPower:MARKer:COUPle[:STATe]?	373
:CALCulate:ACPower:MARKer[1] 2 3 4 5 6 7 8 9 10 11 12:MAXimum	410
:CALCulate:ACPower:MARKer[1] 2 3 4 5 6 7 8 9 10 11 12:MAXimum:LEFT	411
:CALCulate:ACPower:MARKer[1] 2 3 4 5 6 7 8 9 10 11 12:MAXimum:NEXT	410
:CALCulate:ACPower:MARKer[1] 2 3 4 5 6 7 8 9 10 11 12:MAXimum:RIGHT	410
:CALCulate:ACPower:MARKer[1] 2 3 4 5 6 7 8 9 10 11 12:MINimum	412
:CALCulate:ACPower:MARKer[1] 2 3 4 5 6 7 8 9 10 11 12:MODE POSition DELTA OFF	368
:CALCulate:ACPower:MARKer[1] 2 3 4 5 6 7 8 9 10 11 12:MODE?	368

List of Commands

:CALCulate:ACPower:MARKer[1] 2 3 4 5 6 7 8 9 10 11 12:PTPeak	411
:CALCulate:ACPower:MARKer[1] 2 3 4 5 6 7 8 9 10 11 12:REFeRence <integer>	371
:CALCulate:ACPower:MARKer[1] 2 3 4 5 6 7 8 9 10 11 12:REFeRence?	371
:CALCulate:ACPower:MARKer[1] 2 3 4 5 6 7 8 9 10 11 12:TRACe 1 2 3	372
:CALCulate:ACPower:MARKer[1] 2 3 4 5 6 7 8 9 10 11 12:TRACe?	372
:CALCulate:ACPower:MARKer[1] 2 3 4 5 6 7 8 9 10 11 12:X <freq>	369
:CALCulate:ACPower:MARKer[1] 2 3 4 5 6 7 8 9 10 11 12:X:POSition <real>	370
:CALCulate:ACPower:MARKer[1] 2 3 4 5 6 7 8 9 10 11 12:X:POSition?	370
:CALCulate:ACPower:MARKer[1] 2 3 4 5 6 7 8 9 10 11 12:X?	369
:CALCulate:ACPower:MARKer[1] 2 3 4 5 6 7 8 9 10 11 12:Y?	370
:CALCulate:CDPower:MARKer:AOFF	785
:CALCulate:CDPower:MARKer:COUPle[:STATe] ON OFF 1 0	785
:CALCulate:CDPower:MARKer:COUPle[:STATe]?	785
:CALCulate:CDPower:MARKer[1] 2 3 4 5 6 7 8 9 10 11 12:MAXimum	795
:CALCulate:CDPower:MARKer[1] 2 3 4 5 6 7 8 9 10 11 12:MAXimum:LEFT	796
:CALCulate:CDPower:MARKer[1] 2 3 4 5 6 7 8 9 10 11 12:MAXimum:NEXT	795
:CALCulate:CDPower:MARKer[1] 2 3 4 5 6 7 8 9 10 11 12:MAXimum:RIGHT	795
:CALCulate:CDPower:MARKer[1] 2 3 4 5 6 7 8 9 10 11 12:MINimum	796
:CALCulate:CDPower:MARKer[1] 2 3 4 5 6 7 8 9 10 11 12:MODE POSition DELTA OFF	780
:CALCulate:CDPower:MARKer[1] 2 3 4 5 6 7 8 9 10 11 12:MODE?	780
:CALCulate:CDPower:MARKer[1] 2 3 4 5 6 7 8 9 10 11 12:PTPeak	796
:CALCulate:CDPower:MARKer[1] 2 3 4 5 6 7 8 9 10 11 12:REFeRence <integer>	784
:CALCulate:CDPower:MARKer[1] 2 3 4 5 6 7 8 9 10 11 12:REFeRence?	784
:CALCulate:CDPower:MARKer[1] 2 3 4 5 6 7 8 9 10 11 12:STATe OFF ON 0 1	786
:CALCulate:CDPower:MARKer[1] 2 3 4 5 6 7 8 9 10 11 12:STATe?	786
:CALCulate:CDPower:MARKer[1] 2 3 4 5 6 7 8 9 10 11 12:SYMBol <real>	781
:CALCulate:CDPower:MARKer[1] 2 3 4 5 6 7 8 9 10 11 12:SYMBol?	781
:CALCulate:CDPower:MARKer[1] 2 3 4 5 6 7 8 9 10 11 12:TRACe CDPower CDError EVM MERRor PER- Ror SYMPower POLar	784
:CALCulate:CDPower:MARKer[1] 2 3 4 5 6 7 8 9 10 11 12:TRACe?	784
:CALCulate:CDPower:MARKer[1] 2 3 4 5 6 7 8 9 10 11 12:X <real>	782

List of Commands

:CALCulate:CDPower:MARKer[1] 2 3 4 5 6 7 8 9 10 11 12:X:POSition <real>	782
:CALCulate:CDPower:MARKer[1] 2 3 4 5 6 7 8 9 10 11 12:X:POSition?.	782
:CALCulate:CDPower:MARKer[1] 2 3 4 5 6 7 8 9 10 11 12:X?	782
:CALCulate:CDPower:MARKer[1] 2 3 4 5 6 7 8 9 10 11 12:Y?	783
:CALCulate:CLIMits:FAIL?	1133
:CALCulate:DATA<n>:COMPRESS? BLOCK CFIT MAXimum MINimum MEAN DMEan RMS RM- SCubed SAMPLE SDEViation PPHase [,<soffset>[,<length>[,<roffset>[,<rlimit>]]]]	1134
:CALCulate:DATA[1] 2 3 4 5 6:PEAKs? <threshold>,<excursion>[,AMPLitude FREQuency TIME[,ALL GTD- Line LTDLine]].	1139
:CALCulate:DATA[1] 2 3 4 5 6:PEAKs? <threshold>,<excursion>[,AMPLitude FREQuency TIME]	1139
:CALCulate:DATA[n]?.	1133
:CALCulate:EVM:LIMit[1] 2:FERRor <real>	881
:CALCulate:EVM:LIMit[1] 2:FERRor?	881
:CALCulate:EVM:LIMit[1] 2:PCDE <rel_amp>	880
:CALCulate:EVM:LIMit[1] 2:PCDE?	880
:CALCulate:EVM:LIMit[1] 2:PEAK <real>	879
:CALCulate:EVM:LIMit[1] 2:PEAK?	879
:CALCulate:EVM:LIMit[1] 2:RHO <real>	880
:CALCulate:EVM:LIMit[1] 2:RHO?	880
:CALCulate:EVM:LIMit[1] 2:RMS <real>	879
:CALCulate:EVM:LIMit[1] 2:RMS?	879
:CALCulate:EVM:MARKer:AOFF	871
:CALCulate:EVM:MARKer:COUPle[:STATe] ON OFF 1 0.	871
:CALCulate:EVM:MARKer:COUPle[:STATe]?	871
:CALCulate:EVM:MARKer[1] 2 3 4 5 6 7 8 9 10 11 12:CHIP <real>	867
:CALCulate:EVM:MARKer[1] 2 3 4 5 6 7 8 9 10 11 12:CHIP?	867
:CALCulate:EVM:MARKer[1] 2 3 4 5 6 7 8 9 10 11 12:MAXimum	885
:CALCulate:EVM:MARKer[1] 2 3 4 5 6 7 8 9 10 11 12:MAXimum:LEFT	886
:CALCulate:EVM:MARKer[1] 2 3 4 5 6 7 8 9 10 11 12:MAXimum:NEXT	885
:CALCulate:EVM:MARKer[1] 2 3 4 5 6 7 8 9 10 11 12:MAXimum:RIGHT	885
:CALCulate:EVM:MARKer[1] 2 3 4 5 6 7 8 9 10 11 12:MINimum	886
:CALCulate:EVM:MARKer[1] 2 3 4 5 6 7 8 9 10 11 12:MODE POSition DELTA OFF	866

List of Commands

:CALCulate:EVM:MARKer[1] 2 3 4 5 6 7 8 9 10 11 12:MODE?	866
:CALCulate:EVM:MARKer[1] 2 3 4 5 6 7 8 9 10 11 12:PTPeak	886
:CALCulate:EVM:MARKer[1] 2 3 4 5 6 7 8 9 10 11 12:REFerence <integer>	870
:CALCulate:EVM:MARKer[1] 2 3 4 5 6 7 8 9 10 11 12:REFerence?	870
:CALCulate:EVM:MARKer[1] 2 3 4 5 6 7 8 9 10 11 12:STATe OFF ON 0 1	872
:CALCulate:EVM:MARKer[1] 2 3 4 5 6 7 8 9 10 11 12:STATe?	872
:CALCulate:EVM:MARKer[1] 2 3 4 5 6 7 8 9 10 11 12:TRACe POLar MERRor PERRor EVM CDPower CAP-Time	870
:CALCulate:EVM:MARKer[1] 2 3 4 5 6 7 8 9 10 11 12:TRACe?	870
:CALCulate:EVM:MARKer[1] 2 3 4 5 6 7 8 9 10 11 12:X <real>	868
:CALCulate:EVM:MARKer[1] 2 3 4 5 6 7 8 9 10 11 12:X:POSition <real>	868
:CALCulate:EVM:MARKer[1] 2 3 4 5 6 7 8 9 10 11 12:X:POSition?	868
:CALCulate:EVM:MARKer[1] 2 3 4 5 6 7 8 9 10 11 12:X?	868
:CALCulate:EVM:MARKer[1] 2 3 4 5 6 7 8 9 10 11 12:Y?	869
:CALCulate:MONitor:MARKer:AOFF	1008
:CALCulate:MONitor:MARKer:COUPl[e[:STATe] ON OFF 1 0	1008
:CALCulate:MONitor:MARKer:COUPl[e[:STATe]?	1008
:CALCulate:MONitor:MARKer[1] 2 3 4 5 6 7 8 9 10 11 12:FUNcTion NOISe BPOWer BDENsity OFF	1009
:CALCulate:MONitor:MARKer[1] 2 3 4 5 6 7 8 9 10 11 12:FUNcTion:BAND:LEFT <freq>	1010
:CALCulate:MONitor:MARKer[1] 2 3 4 5 6 7 8 9 10 11 12:FUNcTion:BAND:LEFT?	1010
:CALCulate:MONitor:MARKer[1] 2 3 4 5 6 7 8 9 10 11 12:FUNcTion:BAND:RIGHT <freq>	1011
:CALCulate:MONitor:MARKer[1] 2 3 4 5 6 7 8 9 10 11 12:FUNcTion:BAND:RIGHT?	1011
:CALCulate:MONitor:MARKer[1] 2 3 4 5 6 7 8 9 10 11 12:FUNcTion:BAND:SPAN <freq>	1010
:CALCulate:MONitor:MARKer[1] 2 3 4 5 6 7 8 9 10 11 12:FUNcTion:BAND:SPAN?	1010
:CALCulate:MONitor:MARKer[1] 2 3 4 5 6 7 8 9 10 11 12:FUNcTion?	1009
:CALCulate:MONitor:MARKer[1] 2 3 4 5 6 7 8 9 10 11 12:MODE POSition DELTA OFF	1004
:CALCulate:MONitor:MARKer[1] 2 3 4 5 6 7 8 9 10 11 12:MODE?	1004
:CALCulate:MONitor:MARKer[1] 2 3 4 5 6 7 8 9 10 11 12:REFerence <integer>	1007
:CALCulate:MONitor:MARKer[1] 2 3 4 5 6 7 8 9 10 11 12:REFerence?	1007
:CALCulate:MONitor:MARKer[1] 2 3 4 5 6 7 8 9 10 11 12:TRACe <integer>	1007
:CALCulate:MONitor:MARKer[1] 2 3 4 5 6 7 8 9 10 11 12:TRACe?	1007

List of Commands

:CALCulate:MONitor:MARKer[1] 2 3 4 5 6 7 8 9 10 11 12:X <freq>	1005
:CALCulate:MONitor:MARKer[1] 2 3 4 5 6 7 8 9 10 11 12:X:POSition <real>	1005
:CALCulate:MONitor:MARKer[1] 2 3 4 5 6 7 8 9 10 11 12:X:POSition?	1005
:CALCulate:MONitor:MARKer[1] 2 3 4 5 6 7 8 9 10 11 12:X?	1005
:CALCulate:MONitor:MARKer[1] 2 3 4 5 6 7 8 9 10 11 12:Y?	1006
:CALCulate:OBWidth:LIMit:FBLimit <freq>.	683
:CALCulate:OBWidth:LIMit:FBLimit?.	683
:CALCulate:OBWidth:LIMit[:TEST] ON OFF 1 0	683
:CALCulate:OBWidth:LIMit[:TEST]?	683
:CALCulate:OBWidth:MARKer:AOFF	675
:CALCulate:OBWidth:MARKer[1] 2 3 4 5 6 7 8 9 10 11 12:MAXimum.	687
:CALCulate:OBWidth:MARKer[1] 2 3 4 5 6 7 8 9 10 11 12:MODE POSition DELTA OFF	674
:CALCulate:OBWidth:MARKer[1] 2 3 4 5 6 7 8 9 10 11 12:MODE?	674
:CALCulate:OBWidth:MARKer[1] 2 3 4 5 6 7 8 9 10 11 12:REference <integer>.	675
:CALCulate:OBWidth:MARKer[1] 2 3 4 5 6 7 8 9 10 11 12:REference?	675
:CALCulate:OBWidth:MARKer[1] 2 3 4 5 6 7 8 9 10 11 12:X <real>.	672
:CALCulate:OBWidth:MARKer[1] 2 3 4 5 6 7 8 9 10 11 12:X:POSition <real>	673
:CALCulate:OBWidth:MARKer[1] 2 3 4 5 6 7 8 9 10 11 12:X:POSition?	673
:CALCulate:OBWidth:MARKer[1] 2 3 4 5 6 7 8 9 10 11 12:X?.	672
:CALCulate:OBWidth:MARKer[1] 2 3 4 5 6 7 8 9 10 11 12:Y?.	673
:CALCulate:PStatistic:MARKer:AOFF	721
:CALCulate:PStatistic:MARKer[1] 2 3 4 5 6 7 8 9 10 11 12:MODE POSition DELTA OFF.	717
:CALCulate:PStatistic:MARKer[1] 2 3 4 5 6 7 8 9 10 11 12:MODE?.	717
:CALCulate:PStatistic:MARKer[1] 2 3 4 5 6 7 8 9 10 11 12:REference <integer>	720
:CALCulate:PStatistic:MARKer[1] 2 3 4 5 6 7 8 9 10 11 12:REference?.	720
:CALCulate:PStatistic:MARKer[1] 2 3 4 5 6 7 8 9 10 11 12:TRACe MEASured GAUSSian REference	720
:CALCulate:PStatistic:MARKer[1] 2 3 4 5 6 7 8 9 10 11 12:TRACe?	720
:CALCulate:PStatistic:MARKer[1] 2 3 4 5 6 7 8 9 10 11 12:X <rel_ampl>	718
:CALCulate:PStatistic:MARKer[1] 2 3 4 5 6 7 8 9 10 11 12:X?	718
:CALCulate:PStatistic:MARKer[1] 2 3 4 5 6 7 8 9 10 11 12:Y?	719
:CALCulate:PStatistic:STORe:REference	741

List of Commands

:CALCulate:PVTime:MARKer:AOff	455
:CALCulate:PVTime:MARKer:COUple[:STATe] ON OFF 1 0	455
:CALCulate:PVTime:MARKer:COUple[:STATe]?	455
:CALCulate:PVTime:MARKer[1] 2 3 4 5 6 7 8 9 10 11 12:MODE POSition DELTA OFF	450
:CALCulate:PVTime:MARKer[1] 2 3 4 5 6 7 8 9 10 11 12:MODE?	450
:CALCulate:PVTime:MARKer[1] 2 3 4 5 6 7 8 9 10 11 12:REFerence <integer>.	453
:CALCulate:PVTime:MARKer[1] 2 3 4 5 6 7 8 9 10 11 12:REFerence?	453
:CALCulate:PVTime:MARKer[1] 2 3 4 5 6 7 8 9 10 11 12:STATe OFF ON 0 1	455
:CALCulate:PVTime:MARKer[1] 2 3 4 5 6 7 8 9 10 11 12:STATe?	455
:CALCulate:PVTime:MARKer[1] 2 3 4 5 6 7 8 9 10 11 12:TRACe RFENvelope UMASK LMASK MAXHold MIN-Hold	454
:CALCulate:PVTime:MARKer[1] 2 3 4 5 6 7 8 9 10 11 12:TRACe?	454
:CALCulate:PVTime:MARKer[1] 2 3 4 5 6 7 8 9 10 11 12:X <real>.	451
:CALCulate:PVTime:MARKer[1] 2 3 4 5 6 7 8 9 10 11 12:X:POSition <real>.	452
:CALCulate:PVTime:MARKer[1] 2 3 4 5 6 7 8 9 10 11 12:X:POSition?	452
:CALCulate:PVTime:MARKer[1] 2 3 4 5 6 7 8 9 10 11 12:X?	451
:CALCulate:PVTime:MARKer[1] 2 3 4 5 6 7 8 9 10 11 12:Y?	453
:CALCulate:SEMAsk:LLINE:STATe ON OFF 1 0	587
:CALCulate:SEMAsk:LLINE:STATe?	587
:CALCulate:SEMAsk:MARKer:AOff	516
:CALCulate:SEMAsk:MARKer:COUple[:STATe] ON OFF 1 0	516
:CALCulate:SEMAsk:MARKer:COUple[:STATe]?	516
:CALCulate:SEMAsk:MARKer[1] 2 3 4 5 6 7 8 9 10 11 12:MODE POSition OFF	513
:CALCulate:SEMAsk:MARKer[1] 2 3 4 5 6 7 8 9 10 11 12:MODE?	513
:CALCulate:SEMAsk:MARKer[1] 2 3 4 5 6 7 8 9 10 11 12:X <freq>	514
:CALCulate:SEMAsk:MARKer[1] 2 3 4 5 6 7 8 9 10 11 12:X:POSition <real>.	515
:CALCulate:SEMAsk:MARKer[1] 2 3 4 5 6 7 8 9 10 11 12:X:POSition?	515
:CALCulate:SEMAsk:MARKer[1] 2 3 4 5 6 7 8 9 10 11 12:X?	514
:CALCulate:SEMAsk:MARKer[1] 2 3 4 5 6 7 8 9 10 11 12:Y?	515
:CALCulate:SPURious:MARKer:AOff	604
:CALCulate:SPURious:MARKer:COUple[:STATe] ON OFF 1 0	604

List of Commands

:CALCulate:SPURious:MARKer:COUPlE[:STATe]?	604
:CALCulate:SPURious:MARKer[1] 2 3 4 5 6 7 8 9 10 11 12:MAXimum	641
:CALCulate:SPURious:MARKer[1] 2 3 4 5 6 7 8 9 10 11 12:MAXimum:LEFT	642
:CALCulate:SPURious:MARKer[1] 2 3 4 5 6 7 8 9 10 11 12:MAXimum:NEXT	641
:CALCulate:SPURious:MARKer[1] 2 3 4 5 6 7 8 9 10 11 12:MAXimum:RIGHT	642
:CALCulate:SPURious:MARKer[1] 2 3 4 5 6 7 8 9 10 11 12:MINimum	643
:CALCulate:SPURious:MARKer[1] 2 3 4 5 6 7 8 9 10 11 12:MODE POSition DELTA OFF	600
:CALCulate:SPURious:MARKer[1] 2 3 4 5 6 7 8 9 10 11 12:MODE?	600
:CALCulate:SPURious:MARKer[1] 2 3 4 5 6 7 8 9 10 11 12:PTPeak	642
:CALCulate:SPURious:MARKer[1] 2 3 4 5 6 7 8 9 10 11 12:REFerence <integer>	603
:CALCulate:SPURious:MARKer[1] 2 3 4 5 6 7 8 9 10 11 12:REFerence?	603
:CALCulate:SPURious:MARKer[1] 2 3 4 5 6 7 8 9 10 11 12:X <freq>	601
:CALCulate:SPURious:MARKer[1] 2 3 4 5 6 7 8 9 10 11 12:X:POSition <integer>	602
:CALCulate:SPURious:MARKer[1] 2 3 4 5 6 7 8 9 10 11 12:X:POSition?	602
:CALCulate:SPURious:MARKer[1] 2 3 4 5 6 7 8 9 10 11 12:X?	601
:CALCulate:SPURious:MARKer[1] 2 3 4 5 6 7 8 9 10 11 12:Y?	602
:CALCulate:SPURious[:RANGe][:LIST]:LIMit:ABSolute[:UPPer]:DATA:STOP <ampl>, <ampl>, <ampl>, <ampl>, <ampl>, <ampl>, <ampl>, <ampl>, <ampl>, <ampl>, <ampl>, <ampl>, <ampl>, <ampl>, <ampl>, <ampl>, <ampl>	618
:CALCulate:SPURious[:RANGe][:LIST]:LIMit:ABSolute[:UPPer]:DATA:STOP:AUTO OFF ON 0 1, OFF ON 0 1, OFF ON 0 1, OFF ON 0 1, OFF ON 0 1, OFF ON 0 1, OFF ON 0 1, OFF ON 0 1, OFF ON 0 1, OFF ON 0 1, OFF ON 0 1, OFF ON 0 1, OFF ON 0 1, OFF ON 0 1, OFF ON 0 1, OFF ON 0 1, OFF ON 0 1	618
:CALCulate:SPURious[:RANGe][:LIST]:LIMit:ABSolute[:UPPer]:DATA:STOP:AUTO?	618
:CALCulate:SPURious[:RANGe][:LIST]:LIMit:ABSolute[:UPPer]:DATA:STOP?	618
:CALCulate:SPURious[:RANGe][:LIST]:LIMit:ABSolute[:UPPer]:DATA[:START] <ampl>, <ampl>, <ampl>, <ampl>, <ampl>, <ampl>, <ampl>, <ampl>, <ampl>, <ampl>, <ampl>, <ampl>, <ampl>, <ampl>, <ampl>, <ampl>	617
:CALCulate:SPURious[:RANGe][:LIST]:LIMit:ABSolute[:UPPer]:DATA[:START]?	617
:CALCulate:TXPower:MARKer:AOff	313
:CALCulate:TXPower:MARKer:COUPlE[:STATe] ON OFF 1 0	313
:CALCulate:TXPower:MARKer:COUPlE[:STATe]?	313
:CALCulate:TXPower:MARKer[1] 2 3 4 5 6 7 8 9 10 11 12:MAXimum	329
:CALCulate:TXPower:MARKer[1] 2 3 4 5 6 7 8 9 10 11 12:MODE POSition DELTA OFF	308

List of Commands

:CALCulate:TXPower:MARKer[1] 2 3 4 5 6 7 8 9 10 11 12:MODE?	308
:CALCulate:TXPower:MARKer[1] 2 3 4 5 6 7 8 9 10 11 12:REFeRence <integer>	311
:CALCulate:TXPower:MARKer[1] 2 3 4 5 6 7 8 9 10 11 12:REFeRence?	311
:CALCulate:TXPower:MARKer[1] 2 3 4 5 6 7 8 9 10 11 12:TRACe RFENvelopeMAXHold MINHold	312
:CALCulate:TXPower:MARKer[1] 2 3 4 5 6 7 8 9 10 11 12:TRACe?	312
:CALCulate:TXPower:MARKer[1] 2 3 4 5 6 7 8 9 10 11 12:X <real>	309
:CALCulate:TXPower:MARKer[1] 2 3 4 5 6 7 8 9 10 11 12:X:POSition <real>	310
:CALCulate:TXPower:MARKer[1] 2 3 4 5 6 7 8 9 10 11 12:X:POSition?	310
:CALCulate:TXPower:MARKer[1] 2 3 4 5 6 7 8 9 10 11 12:X?	309
:CALCulate:TXPower:MARKer[1] 2 3 4 5 6 7 8 9 10 11 12:Y?	311
:CALCulate:WAVeform:MARKer:AOFF	959
:CALCulate:WAVeform:MARKer:COUPle[:STATe] ON OFF 1 0	959
:CALCulate:WAVeform:MARKer:COUPle[:STATe]?	959
:CALCulate:WAVeform:MARKer[1] 2 3 4 5 6 7 8 9 10 11 12:FUNCTion BPOWer BDENsity OFF	960
:CALCulate:WAVeform:MARKer[1] 2 3 4 5 6 7 8 9 10 11 12:FUNCTion:BAND:LEFt <time>	962
:CALCulate:WAVeform:MARKer[1] 2 3 4 5 6 7 8 9 10 11 12:FUNCTion:BAND:LEFt?	962
:CALCulate:WAVeform:MARKer[1] 2 3 4 5 6 7 8 9 10 11 12:FUNCTion:BAND:RIGHt <time>	962
:CALCulate:WAVeform:MARKer[1] 2 3 4 5 6 7 8 9 10 11 12:FUNCTion:BAND:RIGHt?	962
:CALCulate:WAVeform:MARKer[1] 2 3 4 5 6 7 8 9 10 11 12:FUNCTion:BAND:SPAN <time>	961
:CALCulate:WAVeform:MARKer[1] 2 3 4 5 6 7 8 9 10 11 12:FUNCTion:BAND:SPAN?	961
:CALCulate:WAVeform:MARKer[1] 2 3 4 5 6 7 8 9 10 11 12:FUNCTion?	960
:CALCulate:WAVeform:MARKer[1] 2 3 4 5 6 7 8 9 10 11 12:MAXimum	974
:CALCulate:WAVeform:MARKer[1] 2 3 4 5 6 7 8 9 10 11 12:MAXimum:NEXt	974
:CALCulate:WAVeform:MARKer[1] 2 3 4 5 6 7 8 9 10 11 12:MINimum	974
:CALCulate:WAVeform:MARKer[1] 2 3 4 5 6 7 8 9 10 11 12:MODE POSition DELTA OFF	954
:CALCulate:WAVeform:MARKer[1] 2 3 4 5 6 7 8 9 10 11 12:MODE?	954
:CALCulate:WAVeform:MARKer[1] 2 3 4 5 6 7 8 9 10 11 12:REFeRence <integer>	958
:CALCulate:WAVeform:MARKer[1] 2 3 4 5 6 7 8 9 10 11 12:REFeRence?	958
:CALCulate:WAVeform:MARKer[1] 2 3 4 5 6 7 8 9 10 11 12:TRACe RFENvelopeIQ	958
:CALCulate:WAVeform:MARKer[1] 2 3 4 5 6 7 8 9 10 11 12:TRACe?	958
:CALCulate:WAVeform:MARKer[1] 2 3 4 5 6 7 8 9 10 11 12:X <time>	955

List of Commands

:CALCulate:WAVeform:MARKer[1] 2 3 4 5 6 7 8 9 10 11 12:X:POSition <real>	956
:CALCulate:WAVeform:MARKer[1] 2 3 4 5 6 7 8 9 10 11 12:X:POSition?	956
:CALCulate:WAVeform:MARKer[1] 2 3 4 5 6 7 8 9 10 11 12:X?	955
:CALCulate:WAVeform:MARKer[1] 2 3 4 5 6 7 8 9 10 11 12:Y?	957
:CALibration:AUTO ON PARTial OFF ALERT.	218
:CALibration:AUTO:ALERT TTEMPerature DAY WEEK NONE	221
:CALibration:AUTO:ALERT?	221
:CALibration:AUTO:MODE ALL NRF	221
:CALibration:AUTO:MODE?	221
:CALibration:AUTO:TIME:OFF?	232
:CALibration:AUTO?	218
:CALibration:DATA:BACKup <filename>	241
:CALibration:DATA:DEFault	236
:CALibration:DATA:RESTore <filename>	241
:CALibration:FREQuency:REFerence:COARse <integer>.	234
:CALibration:FREQuency:REFerence:COARse?	234
:CALibration:FREQuency:REFerence:FINE <integer>	234
:CALibration:FREQuency:REFerence:FINE?	234
:CALibration:FREQuency:REFerence:MODE CALibrated USER.	233
:CALibration:FREQuency:REFerence:MODE?	233
:CALibration:IQ:FLATness:I	1111
:CALibration:IQ:FLATness:I IBAR Q QBAR:TIME?	1115
:CALibration:IQ:FLATness:IBAR	1112
:CALibration:IQ:FLATness:Q	1113
:CALibration:IQ:FLATness:QBAR	1114
:CALibration:IQ:ISOLation	1110
:CALibration:IQ:ISOLation:TIME?	1110
:CALibration:IQ:PROBe:I	1116
:CALibration:IQ:PROBe:I IBAR Q QBAR:TIME?	1120
:CALibration:IQ:PROBe:I Q:CLEar	1081
:CALibration:IQ:PROBe:IBar	1117

List of Commands

:CALibration:IQ:PROBe:Q	1118
:CALibration:IQ:PROBe:QBar	1119
:CALibration:NRF?	226
:CALibration:NRF	226
:CALibration:RF?	227
:CALibration:RF	227
:CALibration:TEMPerature:CURRent?	230
:CALibration:TEMPerature:LALL?	231
:CALibration:TEMPerature:LPreselector?	232
:CALibration:TEMPerature:LRF?	232
:CALibration:TIME:LALL?	231
:CALibration:TIME:LPreselector?	232
:CALibration:TIME:LRF?	231
:CALibration:YTF?	229
:CALibration:YTF	229
:CALibration[:ALL]?	224
:CALibration[:ALL]	224
:CONFigure:ACP:NDEFault	349
:CONFigure:ACPower	407
:CONFigure:ACP	349
:CONFigure:CDPower	792
:CONFigure:CDPower:NDEFault	749
:CONFigure:CDPower	749
:CONFigure:EVM	882
:CONFigure:MONitor	1015
:CONFigure:MONitor	991
:CONFigure:MONitor:NDEFault	991
:CONFigure:OBWidth	684
:CONFigure:OBWidth:NDEFault	657
:CONFigure:OBWidth	657
:CONFigure:PStatistic	730

List of Commands

:CONFigure:PStatistic:NDEFault	707
:CONFigure:PStatistic	707
:CONFigure:PVTime	464
:CONFigure:PVTime:NDEFault	437
:CONFigure:PVTime	437
:CONFigure:SEMask	549
:CONFigure:SEMask:NDEFault	493
:CONFigure:SEMask	493
:CONFigure:SPURious	630
:CONFigure:SPURious:NDEFault	589
:CONFigure:SPURious	589
:CONFigure:TXPower	326
:CONFigure:TXPower BPower:NDEFault	295
:CONFigure:TXPower BPower	295
:CONFigure:WAVEform	968
:CONFigure:WAVEform:NDEFault	931
:CONFigure:WAVEform	931
:CONFigure?	1132
:COUPle ALL NONE	1055
:DISPlay:<measurement>:ANNotation:TITLe:DATA <string>	1311
:DISPlay:<measurement>:ANNotation:TITLe:DATA?	1311
:DISPlay:ACPower:VIEW[1]:WINDow[1]:BGRaph OFF ON 0 1	434
:DISPlay:ACPower:VIEW[1]:WINDow[1]:BGRaph?	434
:DISPlay:ACPower:VIEW[1]:WINDow[1]:TRACe:Y[:SCALE]:COUPle 0 1 OFF ON	358
:DISPlay:ACPower:VIEW[1]:WINDow[1]:TRACe:Y[:SCALE]:COUPle?	358
:DISPlay:ACPower:VIEW[1]:WINDow[1]:TRACe:Y[:SCALE]:PDIVision <rel_ampl>	357
:DISPlay:ACPower:VIEW[1]:WINDow[1]:TRACe:Y[:SCALE]:PDIVision?	357
:DISPlay:ACPower:VIEW[1]:WINDow[1]:TRACe:Y[:SCALE]:RLEVel <real>	356
:DISPlay:ACPower:VIEW[1]:WINDow[1]:TRACe:Y[:SCALE]:RLEVel?	356
:DISPlay:ACPower:VIEW[1]:WINDow[1]:TRACe:Y[:SCALE]:RPOSition TOP CENTer BOTTom	358
:DISPlay:ACPower:VIEW[1]:WINDow[1]:TRACe:Y[:SCALE]:RPOSition?	358

List of Commands

:DISPlay:ACTivefunc[:STATe] ON OFF 1 0	1310
:DISPlay:ACTivefunc[:STATe]?	1310
:DISPlay:ANNotation:MBAR[:STATe] OFF ON 0 1	1308
:DISPlay:ANNotation:MBAR[:STATe]?	1308
:DISPlay:ANNotation:SCREen[:STATe] OFF ON 0 1	1309
:DISPlay:ANNotation:SCREen[:STATe]?	1309
:DISPlay:ANNotation:TRACe[:STATe] ON OFF 1 0	1309
:DISPlay:ANNotation:TRACe[:STATe]?	1309
:DISPlay:BACKlight ON OFF	1314
:DISPlay:BACKlight:INTensity <integer>	1315
:DISPlay:BACKlight:INTensity?	1315
:DISPlay:BACKlight?	1314
:DISPlay:CDPower:COMPosite OFF ON 0 1	832
:DISPlay:CDPower:COMPosite?	832
:DISPlay:CDPower:DBITs:FORMat BINary HEX	832
:DISPlay:CDPower:DBITs:FORMat?	832
:DISPlay:CDPower:FVECTor[:STATe] OFF ON 0 1	831
:DISPlay:CDPower:FVECTor[:STATe]?	831
:DISPlay:CDPower:INTerpolate OFF ON 0 1	830
:DISPlay:CDPower:INTerpolate?	830
:DISPlay:CDPower:IQPoints <integer>	829
:DISPlay:CDPower:IQPoints:OFFSet <integer>	829
:DISPlay:CDPower:IQPoints:OFFSet?	829
:DISPlay:CDPower:IQPoints?	829
:DISPlay:CDPower:IQPTyPe VCONStln VECTor CONStln	828
:DISPlay:CDPower:IQPTyPe?	828
:DISPlay:CDPower:ROtation OFF ON 0 1	830
:DISPlay:CDPower:ROtation?	830
:DISPlay:CDPower:SCLength <integer>	833
:DISPlay:CDPower:SCLength?	833
:DISPlay:CDPower:VIEW:NSElect <integer>	827

List of Commands

:DISPlay:CDPower:VIEW:NSElect?	827
:DISPlay:CDPower:VIEW?	824
:DISPlay:CDPower:VIEW[:SElect] CDPGraph CDEGraph IQERror CDOMain DBITs RESMetrics	824
:DISPlay:CDPower:VIEW[1] 4 5:WINDow[1]:TRACe:X[:SCALe]:PDIVision <integer>	811
:DISPlay:CDPower:VIEW[1] 4 5:WINDow[1]:TRACe:X[:SCALe]:PDIVision?	811
:DISPlay:CDPower:VIEW[1] 4 5:WINDow[1]:TRACe:X[:SCALe]:RLEVel <integer>	806
:DISPlay:CDPower:VIEW[1] 4 5:WINDow[1]:TRACe:X[:SCALe]:RLEVel?	806
:DISPlay:CDPower:VIEW[1] 4 5:WINDow[1]:TRACe:X[:SCALe]:RPOSitioN LEFT CENTer RIGHT	814
:DISPlay:CDPower:VIEW[1] 4 5:WINDow[1]:TRACe:X[:SCALe]:RPOSitioN?	814
:DISPlay:CDPower:VIEW[1] 4 5:WINDow[1]:TRACe:Y[:SCALe]:COUPle 0 1 OFF ON	773
:DISPlay:CDPower:VIEW[1] 4 5:WINDow[1]:TRACe:Y[:SCALe]:COUPle?	773
:DISPlay:CDPower:VIEW[1] 4 5:WINDow[1]:TRACe:Y[:SCALe]:PDIVision <rel_ampl>	764
:DISPlay:CDPower:VIEW[1] 4 5:WINDow[1]:TRACe:Y[:SCALe]:PDIVision?	764
:DISPlay:CDPower:VIEW[1] 4 5:WINDow[1]:TRACe:Y[:SCALe]:RLEVel <real>	759
:DISPlay:CDPower:VIEW[1] 4 5:WINDow[1]:TRACe:Y[:SCALe]:RLEVel?	759
:DISPlay:CDPower:VIEW[1] 4 5:WINDow[1]:TRACe:Y[:SCALe]:RPOSitioN TOP CENTer BOTTom	768
:DISPlay:CDPower:VIEW[1] 4 5:WINDow[1]:TRACe:Y[:SCALe]:RPOSitioN?	768
:DISPlay:CDPower:VIEW2:WINDow[1]:TRACe:X[:SCALe]:PDIVision <integer>	811
:DISPlay:CDPower:VIEW2:WINDow[1]:TRACe:X[:SCALe]:PDIVision?	811
:DISPlay:CDPower:VIEW2:WINDow[1]:TRACe:X[:SCALe]:RLEVel <integer>	807
:DISPlay:CDPower:VIEW2:WINDow[1]:TRACe:X[:SCALe]:RLEVel?	807
:DISPlay:CDPower:VIEW2:WINDow[1]:TRACe:X[:SCALe]:RPOSitioN LEFT CENTer RIGHT	815
:DISPlay:CDPower:VIEW2:WINDow[1]:TRACe:X[:SCALe]:RPOSitioN?	815
:DISPlay:CDPower:VIEW2:WINDow[1]:TRACe:Y[:SCALe]:COUPle 0 1 OFF ON	773
:DISPlay:CDPower:VIEW2:WINDow[1]:TRACe:Y[:SCALe]:COUPle?	773
:DISPlay:CDPower:VIEW2:WINDow[1]:TRACe:Y[:SCALe]:PDIVision <rel_ampl>	765
:DISPlay:CDPower:VIEW2:WINDow[1]:TRACe:Y[:SCALe]:PDIVision?	765
:DISPlay:CDPower:VIEW2:WINDow[1]:TRACe:Y[:SCALe]:RLEVel <real>	760
:DISPlay:CDPower:VIEW2:WINDow[1]:TRACe:Y[:SCALe]:RLEVel?	760
:DISPlay:CDPower:VIEW2:WINDow[1]:TRACe:Y[:SCALe]:RPOSitioN TOP CENTer BOTTom	769
:DISPlay:CDPower:VIEW2:WINDow[1]:TRACe:Y[:SCALe]:RPOSitioN?	769

List of Commands

:DISPlay:CDPower:VIEW3:WINDow[1]:TRACe:X[:SCALe]:COUPle 0 1 OFF ON	816
:DISPlay:CDPower:VIEW3:WINDow[1]:TRACe:X[:SCALe]:COUPle?	816
:DISPlay:CDPower:VIEW3:WINDow[1]:TRACe:X[:SCALe]:PDIVision <real>	808
:DISPlay:CDPower:VIEW3:WINDow[1]:TRACe:X[:SCALe]:PDIVision?	808
:DISPlay:CDPower:VIEW3:WINDow[1]:TRACe:X[:SCALe]:RLEVel <real>	803
:DISPlay:CDPower:VIEW3:WINDow[1]:TRACe:X[:SCALe]:RLEVel?	803
:DISPlay:CDPower:VIEW3:WINDow[1]:TRACe:X[:SCALe]:RPOSition LEFT CENTer RIGHT	812
:DISPlay:CDPower:VIEW3:WINDow[1]:TRACe:X[:SCALe]:RPOSition?	812
:DISPlay:CDPower:VIEW3:WINDow[1]:TRACe:Y[:SCALe]:COUPle 0 1 OFF ON	770
:DISPlay:CDPower:VIEW3:WINDow[1]:TRACe:Y[:SCALe]:COUPle?	770
:DISPlay:CDPower:VIEW3:WINDow[1]:TRACe:Y[:SCALe]:PDIVision <real>	761
:DISPlay:CDPower:VIEW3:WINDow[1]:TRACe:Y[:SCALe]:PDIVision?	761
:DISPlay:CDPower:VIEW3:WINDow[1]:TRACe:Y[:SCALe]:RLEVel <real>	756
:DISPlay:CDPower:VIEW3:WINDow[1]:TRACe:Y[:SCALe]:RLEVel?	756
:DISPlay:CDPower:VIEW3:WINDow[1]:TRACe:Y[:SCALe]:RPOSition TOP CENTer BOTTom	766
:DISPlay:CDPower:VIEW3:WINDow[1]:TRACe:Y[:SCALe]:RPOSition?	766
:DISPlay:CDPower:VIEW3:WINDow2:TRACe:X[:SCALe]:COUPle 0 1 OFF ON	816
:DISPlay:CDPower:VIEW3:WINDow2:TRACe:X[:SCALe]:COUPle?	816
:DISPlay:CDPower:VIEW3:WINDow2:TRACe:X[:SCALe]:PDIVision <real>	808
:DISPlay:CDPower:VIEW3:WINDow2:TRACe:X[:SCALe]:PDIVision?	808
:DISPlay:CDPower:VIEW3:WINDow2:TRACe:X[:SCALe]:RLEVel <real>	804
:DISPlay:CDPower:VIEW3:WINDow2:TRACe:X[:SCALe]:RLEVel?	804
:DISPlay:CDPower:VIEW3:WINDow2:TRACe:X[:SCALe]:RPOSition LEFT CENTer RIGHT	813
:DISPlay:CDPower:VIEW3:WINDow2:TRACe:X[:SCALe]:RPOSition?	813
:DISPlay:CDPower:VIEW3:WINDow2:TRACe:Y[:SCALe]:COUPle 0 1 OFF ON	771
:DISPlay:CDPower:VIEW3:WINDow2:TRACe:Y[:SCALe]:COUPle?	771
:DISPlay:CDPower:VIEW3:WINDow2:TRACe:Y[:SCALe]:PDIVision <real>	762
:DISPlay:CDPower:VIEW3:WINDow2:TRACe:Y[:SCALe]:PDIVision?	762
:DISPlay:CDPower:VIEW3:WINDow2:TRACe:Y[:SCALe]:RLEVel <real>	757
:DISPlay:CDPower:VIEW3:WINDow2:TRACe:Y[:SCALe]:RLEVel?	757
:DISPlay:CDPower:VIEW3:WINDow2:TRACe:Y[:SCALe]:RPOSition TOP CENTer BOTTom	767

List of Commands

:DISPlay:CDPower:VIEW3:WINDow2:TRACe:Y[:SCALe]:RPOSition?	767
:DISPlay:CDPower:VIEW3:WINDow3:TRACe:X[:SCALe]:COUPlE 0 1 OFF ON	817
:DISPlay:CDPower:VIEW3:WINDow3:TRACe:X[:SCALe]:COUPlE?	817
:DISPlay:CDPower:VIEW3:WINDow3:TRACe:X[:SCALe]:PDIVision <real>	809
:DISPlay:CDPower:VIEW3:WINDow3:TRACe:X[:SCALe]:PDIVision?	809
:DISPlay:CDPower:VIEW3:WINDow3:TRACe:X[:SCALe]:RLEVel <real>	804
:DISPlay:CDPower:VIEW3:WINDow3:TRACe:X[:SCALe]:RLEVel?	804
:DISPlay:CDPower:VIEW3:WINDow3:TRACe:X[:SCALe]:RPOSition LEFT CENTer RIGHT	813
:DISPlay:CDPower:VIEW3:WINDow3:TRACe:X[:SCALe]:RPOSition?	813
:DISPlay:CDPower:VIEW3:WINDow3:TRACe:Y[:SCALe]:COUPlE 0 1 OFF ON	771
:DISPlay:CDPower:VIEW3:WINDow3:TRACe:Y[:SCALe]:COUPlE?	771
:DISPlay:CDPower:VIEW3:WINDow3:TRACe:Y[:SCALe]:PDIVision <real>	763
:DISPlay:CDPower:VIEW3:WINDow3:TRACe:Y[:SCALe]:PDIVision?	763
:DISPlay:CDPower:VIEW3:WINDow3:TRACe:Y[:SCALe]:RLEVel <real>	758
:DISPlay:CDPower:VIEW3:WINDow3:TRACe:Y[:SCALe]:RLEVel?	758
:DISPlay:CDPower:VIEW3:WINDow3:TRACe:Y[:SCALe]:RPOSition TOP CENTer BOTTom	767
:DISPlay:CDPower:VIEW3:WINDow3:TRACe:Y[:SCALe]:RPOSition?	767
:DISPlay:CDPower:VIEW4 5:WINDow2:TRACe:X[:SCALe]:COUPlE 0 1 OFF ON	818
:DISPlay:CDPower:VIEW4 5:WINDow2:TRACe:X[:SCALe]:COUPlE?	818
:DISPlay:CDPower:VIEW4 5:WINDow2:TRACe:X[:SCALe]:PDIVision <real>	810
:DISPlay:CDPower:VIEW4 5:WINDow2:TRACe:X[:SCALe]:PDIVision?	810
:DISPlay:CDPower:VIEW4 5:WINDow2:TRACe:X[:SCALe]:RLEVel <real>	805
:DISPlay:CDPower:VIEW4 5:WINDow2:TRACe:X[:SCALe]:RLEVel?	805
:DISPlay:CDPower:VIEW4 5:WINDow2:TRACe:X[:SCALe]:RPOSition LEFT CENTer RIGHT	814
:DISPlay:CDPower:VIEW4 5:WINDow2:TRACe:X[:SCALe]:RPOSition?	814
:DISPlay:CDPower:VIEW4 5:WINDow2:TRACe:Y[:SCALe]:COUPlE 0 1 OFF ON	772
:DISPlay:CDPower:VIEW4 5:WINDow2:TRACe:Y[:SCALe]:COUPlE?	772
:DISPlay:CDPower:VIEW4 5:WINDow2:TRACe:Y[:SCALe]:PDIVision <rel_ampl>	763
:DISPlay:CDPower:VIEW4 5:WINDow2:TRACe:Y[:SCALe]:PDIVision?	763
:DISPlay:CDPower:VIEW4 5:WINDow2:TRACe:Y[:SCALe]:RLEVel <real>	758
:DISPlay:CDPower:VIEW4 5:WINDow2:TRACe:Y[:SCALe]:RLEVel?	758

List of Commands

:DISPlay:CDPower:VIEW4 5:WINDow2:TRACe:Y[:SCALe]:RPOSition TOP CENTer BOTTom	768
:DISPlay:CDPower:VIEW4 5:WINDow2:TRACe:Y[:SCALe]:RPOSition?	768
:DISPlay:ENABle OFF ON 0 1	1316
:DISPlay:ENABle?	1316
:DISPlay:EVM:FVECTor[:STATe] OFF ON 0 1	928
:DISPlay:EVM:FVECTor[:STATe]?	928
:DISPlay:EVM:INTerpolate OFF ON 0 1	927
:DISPlay:EVM:INTerpolate?	927
:DISPlay:EVM:IQPoints <integer>	925
:DISPlay:EVM:IQPoints:OFFSet <integer>	926
:DISPlay:EVM:IQPoints:OFFSet?	926
:DISPlay:EVM:IQPoints?	925
:DISPlay:EVM:IQPTyPe VCONStln VECTor CONStln	924
:DISPlay:EVM:IQPTyPe?	924
:DISPlay:EVM:ROtation OFF ON 0 1	927
:DISPlay:EVM:ROtation?	927
:DISPlay:EVM:VIEW:NSElect <integer>	923
:DISPlay:EVM:VIEW:NSElect?	923
:DISPlay:EVM:VIEW[:SElect] POLar ERRor PGRaph SUMMary NRESults	923
:DISPlay:EVM:VIEW[:SElect]?	923
:DISPlay:EVM:VIEW2:WINDow[1]:TRACe:X[:SCALe]:COUPle 0 1 OFF ON	899
:DISPlay:EVM:VIEW2:WINDow[1]:TRACe:X[:SCALe]:COUPle?	899
:DISPlay:EVM:VIEW2:WINDow[1]:TRACe:X[:SCALe]:PDIVision <real>	893
:DISPlay:EVM:VIEW2:WINDow[1]:TRACe:X[:SCALe]:PDIVision?	893
:DISPlay:EVM:VIEW2:WINDow[1]:TRACe:X[:SCALe]:RLEVel <real>	889
:DISPlay:EVM:VIEW2:WINDow[1]:TRACe:X[:SCALe]:RLEVel?	889
:DISPlay:EVM:VIEW2:WINDow[1]:TRACe:X[:SCALe]:RPOSition LEFT CENTer RIGHT	896
:DISPlay:EVM:VIEW2:WINDow[1]:TRACe:X[:SCALe]:RPOSition?	896
:DISPlay:EVM:VIEW2:WINDow[1]:TRACe:Y[:SCALe]:COUPle 0 1 OFF ON	856
:DISPlay:EVM:VIEW2:WINDow[1]:TRACe:Y[:SCALe]:COUPle?	856
:DISPlay:EVM:VIEW2:WINDow[1]:TRACe:Y[:SCALe]:PDIVision <real>	849

List of Commands

:DISPlay:EVM:VIEW2:WINDow[1]:TRACe:Y[:SCALe]:PDIVision?	849
:DISPlay:EVM:VIEW2:WINDow[1]:TRACe:Y[:SCALe]:RLEVel <real>	845
:DISPlay:EVM:VIEW2:WINDow[1]:TRACe:Y[:SCALe]:RLEVel?	845
:DISPlay:EVM:VIEW2:WINDow[1]:TRACe:Y[:SCALe]:RPOSition TOP CENTer BOTTom	853
:DISPlay:EVM:VIEW2:WINDow[1]:TRACe:Y[:SCALe]:RPOSition?	853
:DISPlay:EVM:VIEW2:WINDow2:TRACe:X[:SCALe]:COUPlE 0 1 OFF ON	900
:DISPlay:EVM:VIEW2:WINDow2:TRACe:X[:SCALe]:COUPlE?	900
:DISPlay:EVM:VIEW2:WINDow2:TRACe:X[:SCALe]:PDIVision <real>	893
:DISPlay:EVM:VIEW2:WINDow2:TRACe:X[:SCALe]:PDIVision?	893
:DISPlay:EVM:VIEW2:WINDow2:TRACe:X[:SCALe]:RLEVel <real>	890
:DISPlay:EVM:VIEW2:WINDow2:TRACe:X[:SCALe]:RLEVel?	890
:DISPlay:EVM:VIEW2:WINDow2:TRACe:X[:SCALe]:RPOSition LEFT CENTer RIGHT.	897
:DISPlay:EVM:VIEW2:WINDow2:TRACe:X[:SCALe]:RPOSition?	897
:DISPlay:EVM:VIEW2:WINDow2:TRACe:Y[:SCALe]:COUPlE 0 1 OFF ON	856
:DISPlay:EVM:VIEW2:WINDow2:TRACe:Y[:SCALe]:COUPlE?	856
:DISPlay:EVM:VIEW2:WINDow2:TRACe:Y[:SCALe]:PDIVision <real>	850
:DISPlay:EVM:VIEW2:WINDow2:TRACe:Y[:SCALe]:PDIVision?	850
:DISPlay:EVM:VIEW2:WINDow2:TRACe:Y[:SCALe]:RLEVel <real>	846
:DISPlay:EVM:VIEW2:WINDow2:TRACe:Y[:SCALe]:RLEVel?	846
:DISPlay:EVM:VIEW2:WINDow2:TRACe:Y[:SCALe]:RPOSition TOP CENTer BOTTom.	853
:DISPlay:EVM:VIEW2:WINDow2:TRACe:Y[:SCALe]:RPOSition?	853
:DISPlay:EVM:VIEW2:WINDow3:TRACe:X[:SCALe]:COUPlE 0 1 OFF ON	900
:DISPlay:EVM:VIEW2:WINDow3:TRACe:X[:SCALe]:COUPlE?	900
:DISPlay:EVM:VIEW2:WINDow3:TRACe:X[:SCALe]:PDIVision <real>	894
:DISPlay:EVM:VIEW2:WINDow3:TRACe:X[:SCALe]:PDIVision?	894
:DISPlay:EVM:VIEW2:WINDow3:TRACe:X[:SCALe]:RLEVel <real>	890
:DISPlay:EVM:VIEW2:WINDow3:TRACe:X[:SCALe]:RLEVel?	890
:DISPlay:EVM:VIEW2:WINDow3:TRACe:X[:SCALe]:RPOSition LEFT CENTer RIGHT.	897
:DISPlay:EVM:VIEW2:WINDow3:TRACe:X[:SCALe]:RPOSition?	897
:DISPlay:EVM:VIEW2:WINDow3:TRACe:Y[:SCALe]:COUPlE 0 1 OFF ON	857
:DISPlay:EVM:VIEW2:WINDow3:TRACe:Y[:SCALe]:COUPlE?	857

List of Commands

:DISPlay:EVM:VIEW2:WINDow3:TRACe:Y[:SCALe]:PDIVision <real>	850
:DISPlay:EVM:VIEW2:WINDow3:TRACe:Y[:SCALe]:PDIVision?	850
:DISPlay:EVM:VIEW2:WINDow3:TRACe:Y[:SCALe]:RLEVel <real>	846
:DISPlay:EVM:VIEW2:WINDow3:TRACe:Y[:SCALe]:RLEVel?	846
:DISPlay:EVM:VIEW2:WINDow3:TRACe:Y[:SCALe]:RPOSition TOP CENTer BOTTom	854
:DISPlay:EVM:VIEW2:WINDow3:TRACe:Y[:SCALe]:RPOSition?	854
:DISPlay:EVM:VIEW3:WINDow[1]:TRACe:X[:SCALe]:PDIVision <Integer>	895
:DISPlay:EVM:VIEW3:WINDow[1]:TRACe:X[:SCALe]:PDIVision?	895
:DISPlay:EVM:VIEW3:WINDow[1]:TRACe:X[:SCALe]:RLEVel <integer>	891
:DISPlay:EVM:VIEW3:WINDow[1]:TRACe:X[:SCALe]:RLEVel?	891
:DISPlay:EVM:VIEW3:WINDow[1]:TRACe:X[:SCALe]:RPOSition LEFT CENTer RIGHT	898
:DISPlay:EVM:VIEW3:WINDow[1]:TRACe:X[:SCALe]:RPOSition?	898
:DISPlay:EVM:VIEW3:WINDow[1]:TRACe:Y[:SCALe]:COUPle 0 1 OFF ON	858
:DISPlay:EVM:VIEW3:WINDow[1]:TRACe:Y[:SCALe]:COUPle?	858
:DISPlay:EVM:VIEW3:WINDow[1]:TRACe:Y[:SCALe]:PDIVision <rel_amp>	851
:DISPlay:EVM:VIEW3:WINDow[1]:TRACe:Y[:SCALe]:PDIVision?	851
:DISPlay:EVM:VIEW3:WINDow[1]:TRACe:Y[:SCALe]:RLEVel <real>	847
:DISPlay:EVM:VIEW3:WINDow[1]:TRACe:Y[:SCALe]:RLEVel?	847
:DISPlay:EVM:VIEW3:WINDow[1]:TRACe:Y[:SCALe]:RPOSition TOP CENTer BOTTom	854
:DISPlay:EVM:VIEW3:WINDow[1]:TRACe:Y[:SCALe]:RPOSition?	854
:DISPlay:EVM:VIEW4:WINDow[1]:TRACe:X[:SCALe]:COUPle 0 1 OFF ON	901
:DISPlay:EVM:VIEW4:WINDow[1]:TRACe:X[:SCALe]:COUPle?	901
:DISPlay:EVM:VIEW4:WINDow[1]:TRACe:X[:SCALe]:PDIVision <time>	895
:DISPlay:EVM:VIEW4:WINDow[1]:TRACe:X[:SCALe]:PDIVision?	895
:DISPlay:EVM:VIEW4:WINDow[1]:TRACe:X[:SCALe]:RLEVel <time>	892
:DISPlay:EVM:VIEW4:WINDow[1]:TRACe:X[:SCALe]:RLEVel?	892
:DISPlay:EVM:VIEW4:WINDow[1]:TRACe:X[:SCALe]:RPOSition LEFT CENTer RIGHT	898
:DISPlay:EVM:VIEW4:WINDow[1]:TRACe:X[:SCALe]:RPOSition?	898
:DISPlay:EVM:VIEW4:WINDow[1]:TRACe:Y[:SCALe]:COUPle 0 1 OFF ON	858
:DISPlay:EVM:VIEW4:WINDow[1]:TRACe:Y[:SCALe]:COUPle?	858
:DISPlay:EVM:VIEW4:WINDow[1]:TRACe:Y[:SCALe]:PDIVision <rel_amp>	852

List of Commands

:DISPlay:EVM:VIEW4:WINDow[1]:TRACe:Y[:SCALe]:PDIVision?	852
:DISPlay:EVM:VIEW4:WINDow[1]:TRACe:Y[:SCALe]:RLEVel <real>	848
:DISPlay:EVM:VIEW4:WINDow[1]:TRACe:Y[:SCALe]:RLEVel?	848
:DISPlay:EVM:VIEW4:WINDow[1]:TRACe:Y[:SCALe]:RPOSition TOP CENTer BOTTom	855
:DISPlay:EVM:VIEW4:WINDow[1]:TRACe:Y[:SCALe]:RPOSition?	855
:DISPlay:FSCReen[:STATe] OFF ON 0 1	1315
:DISPlay:FSCReen[:STATe]?	1315
:DISPlay:MONitor:VIEW:WINDow:TRACe[1] 2 3:CLear	1032
:DISPlay:MONitor:VIEW[1]:WINDow[1]:TRACe:Y[:SCALe]:COUPlE 0 1 OFF ON	994
:DISPlay:MONitor:VIEW[1]:WINDow[1]:TRACe:Y[:SCALe]:COUPlE?	994
:DISPlay:MONitor:VIEW[1]:WINDow[1]:TRACe:Y[:SCALe]:PDIVision <rel_ampl>	993
:DISPlay:MONitor:VIEW[1]:WINDow[1]:TRACe:Y[:SCALe]:PDIVision?	993
:DISPlay:MONitor:VIEW[1]:WINDow[1]:TRACe:Y[:SCALe]:RLEVel <real>	992
:DISPlay:MONitor:VIEW[1]:WINDow[1]:TRACe:Y[:SCALe]:RLEVel?	992
:DISPlay:MONitor:VIEW[1]:WINDow[1]:TRACe:Y[:SCALe]:RPOSition TOP CENTer BOTTom	994
:DISPlay:MONitor:VIEW[1]:WINDow[1]:TRACe:Y[:SCALe]:RPOSition?	994
:DISPlay:OBWidth:VIEW[1]:WINDow[1]:TRACe:Y[:SCALe]:COUPlE 0 1 OFF ON	663
:DISPlay:OBWidth:VIEW[1]:WINDow[1]:TRACe:Y[:SCALe]:COUPlE?	663
:DISPlay:OBWidth:VIEW[1]:WINDow[1]:TRACe:Y[:SCALe]:PDIVision <rel_ampl>	661
:DISPlay:OBWidth:VIEW[1]:WINDow[1]:TRACe:Y[:SCALe]:PDIVision?	661
:DISPlay:OBWidth:VIEW[1]:WINDow[1]:TRACe:Y[:SCALe]:RLEVel <real>	660
:DISPlay:OBWidth:VIEW[1]:WINDow[1]:TRACe:Y[:SCALe]:RLEVel?	660
:DISPlay:OBWidth:VIEW[1]:WINDow[1]:TRACe:Y[:SCALe]:RPOSition TOP CENTer BOTTom	662
:DISPlay:OBWidth:VIEW[1]:WINDow[1]:TRACe:Y[:SCALe]:RPOSition?	662
:DISPlay:PStatistic:VIEW[1]:WINDow2:TRACe:X[:SCALe]:PDIVision <rel_ampl>	739
:DISPlay:PStatistic:VIEW[1]:WINDow2:TRACe:X[:SCALe]:PDIVision?	739
:DISPlay:PVTime:VIEW[1]:WINDow[1]:BLINes[:STATe] ON OFF 1 0	490
:DISPlay:PVTime:VIEW[1]:WINDow[1]:BLINes[:STATe]?	490
:DISPlay:PVTime:VIEW[1]:WINDow[1]:LMASK ON OFF 1 0	491
:DISPlay:PVTime:VIEW[1]:WINDow[1]:LMASK?	491
:DISPlay:PVTime:VIEW[1]:WINDow[1]:RAMP[:STATe] ON OFF 1 0	490

List of Commands

:DISPlay:PVTime:VIEW[1]:WINDow[1]:RAMP[:STATe]?	490
:DISPlay:PVTime:VIEW[1]:WINDow[1]:TRACe:MAXHold[:STATe] ON OFF 1 0	484
:DISPlay:PVTime:VIEW[1]:WINDow[1]:TRACe:MAXHold[:STATe]?	484
:DISPlay:PVTime:VIEW[1]:WINDow[1]:TRACe:MINHold[:STATe] ON OFF 1 0	484
:DISPlay:PVTime:VIEW[1]:WINDow[1]:TRACe:MINHold[:STATe]?	484
:DISPlay:PVTime:VIEW[1]:WINDow[1]:TRACe:X[:SCALe]:COUPlE 0 1 OFF ON	482
:DISPlay:PVTime:VIEW[1]:WINDow[1]:TRACe:X[:SCALe]:COUPlE?	482
:DISPlay:PVTime:VIEW[1]:WINDow[1]:TRACe:X[:SCALe]:PDIVision <time>	481
:DISPlay:PVTime:VIEW[1]:WINDow[1]:TRACe:X[:SCALe]:PDIVision?	481
:DISPlay:PVTime:VIEW[1]:WINDow[1]:TRACe:X[:SCALe]:RLEVel <time>	480
:DISPlay:PVTime:VIEW[1]:WINDow[1]:TRACe:X[:SCALe]:RLEVel?	480
:DISPlay:PVTime:VIEW[1]:WINDow[1]:TRACe:X[:SCALe]:RPOSition LEFT CENTer RIGHT	481
:DISPlay:PVTime:VIEW[1]:WINDow[1]:TRACe:X[:SCALe]:RPOSition?	481
:DISPlay:PVTime:VIEW[1]:WINDow[1]:TRACe:Y[:SCALe]:COUPlE 0 1 OFF ON	444
:DISPlay:PVTime:VIEW[1]:WINDow[1]:TRACe:Y[:SCALe]:COUPlE?	444
:DISPlay:PVTime:VIEW[1]:WINDow[1]:TRACe:Y[:SCALe]:PDIVision <rel_ampl>	443
:DISPlay:PVTime:VIEW[1]:WINDow[1]:TRACe:Y[:SCALe]:PDIVision?	443
:DISPlay:PVTime:VIEW[1]:WINDow[1]:TRACe:Y[:SCALe]:RLEVel <real>	442
:DISPlay:PVTime:VIEW[1]:WINDow[1]:TRACe:Y[:SCALe]:RLEVel?	442
:DISPlay:PVTime:VIEW[1]:WINDow[1]:TRACe:Y[:SCALe]:RPOSition TOP CENTer BOTTom	444
:DISPlay:PVTime:VIEW[1]:WINDow[1]:TRACe:Y[:SCALe]:RPOSition?	444
:DISPlay:PVTime:VIEW[1]:WINDow[1]:TRIGger[:STATe] ON OFF 1 0	489
:DISPlay:PVTime:VIEW[1]:WINDow[1]:TRIGger[:STATe]?	489
:DISPlay:SEMAsk:VIEW:NSELEct <integer>	569
:DISPlay:SEMAsk:VIEW:NSELEct?	569
:DISPlay:SEMAsk:VIEW[:SELEct] APFReq RPFReq IPOWer	568
:DISPlay:SEMAsk:VIEW[:SELEct]?	568
:DISPlay:SEMAsk:VIEW[1]:WINDow[1]:TRACe:Y[:SCALe]:COUPlE 0 1 ON OFF	507
:DISPlay:SEMAsk:VIEW[1]:WINDow[1]:TRACe:Y[:SCALe]:COUPlE?	507
:DISPlay:SEMAsk:VIEW[1]:WINDow[1]:TRACe:Y[:SCALe]:PDIVision <rel_ampl>	505
:DISPlay:SEMAsk:VIEW[1]:WINDow[1]:TRACe:Y[:SCALe]:PDIVision?	505

List of Commands

:DISPlay:SEMAsk:VIEW[1]:WINDow[1]:TRACe:Y[:SCALe]:RLEVel <real>	504
:DISPlay:SEMAsk:VIEW[1]:WINDow[1]:TRACe:Y[:SCALe]:RLEVel?	504
:DISPlay:SEMAsk:VIEW[1]:WINDow[1]:TRACe:Y[:SCALe]:RPOStion TOP CENTer BOTTom.	506
:DISPlay:SEMAsk:VIEW[1]:WINDow[1]:TRACe:Y[:SCALe]:RPOStion?	506
:DISPlay:SPURious:VIEW[1]:WINDow[1]:TRACe:Y[:SCALe]:COUPle 0 1 OFF ON	593
:DISPlay:SPURious:VIEW[1]:WINDow[1]:TRACe:Y[:SCALe]:COUPle?	593
:DISPlay:SPURious:VIEW[1]:WINDow[1]:TRACe:Y[:SCALe]:PDIVision <rel_amp>.	592
:DISPlay:SPURious:VIEW[1]:WINDow[1]:TRACe:Y[:SCALe]:PDIVision?	592
:DISPlay:SPURious:VIEW[1]:WINDow[1]:TRACe:Y[:SCALe]:RLEVel < real>	591
:DISPlay:SPURious:VIEW[1]:WINDow[1]:TRACe:Y[:SCALe]:RLEVel?	591
:DISPlay:THEMe TDColor TDMonochrome FCOLOR FMONochrome	1314
:DISPlay:THEMe?	1314
:DISPlay:TXPower:BARGraph[:STATe] ON OFF 1 0	347
:DISPlay:TXPower:BARGraph[:STATe]?	347
:DISPlay:TXPower:VIEW[1]:WINDow[1]:TRACe:MAXHold[:STATe] ON OFF 1 0	340
:DISPlay:TXPower:VIEW[1]:WINDow[1]:TRACe:MAXHold[:STATe]?	340
:DISPlay:TXPower:VIEW[1]:WINDow[1]:TRACe:MINHold[:STATe] ON OFF 1 0	340
:DISPlay:TXPower:VIEW[1]:WINDow[1]:TRACe:MINHold[:STATe]?	340
:DISPlay:TXPower:VIEW[1]:WINDow[1]:TRACe:X[:SCALe]:COUPle 0 1 OFF ON	337
:DISPlay:TXPower:VIEW[1]:WINDow[1]:TRACe:X[:SCALe]:COUPle?	337
:DISPlay:TXPower:VIEW[1]:WINDow[1]:TRACe:X[:SCALe]:PDIVision <time>.	336
:DISPlay:TXPower:VIEW[1]:WINDow[1]:TRACe:X[:SCALe]:PDIVision?	336
:DISPlay:TXPower:VIEW[1]:WINDow[1]:TRACe:X[:SCALe]:RLEVel <time>.	335
:DISPlay:TXPower:VIEW[1]:WINDow[1]:TRACe:X[:SCALe]:RLEVel?	335
:DISPlay:TXPower:VIEW[1]:WINDow[1]:TRACe:X[:SCALe]:RPOStion LEFT CENTer RIGHT.	336
:DISPlay:TXPower:VIEW[1]:WINDow[1]:TRACe:X[:SCALe]:RPOStion?	336
:DISPlay:TXPower:VIEW[1]:WINDow[1]:TRACe:Y[:SCALe]:COUPle 0 1 OFF ON	300
:DISPlay:TXPower:VIEW[1]:WINDow[1]:TRACe:Y[:SCALe]:COUPle?	300
:DISPlay:TXPower:VIEW[1]:WINDow[1]:TRACe:Y[:SCALe]:PDIVision <rel_amp>	299
:DISPlay:TXPower:VIEW[1]:WINDow[1]:TRACe:Y[:SCALe]:PDIVision?	299
:DISPlay:TXPower:VIEW[1]:WINDow[1]:TRACe:Y[:SCALe]:RLEVel <real>	298

List of Commands

:DISPlay:TXPower:VIEW[1]:WINDow[1]:TRACe:Y[:SCALe]:RLEVel?	298
:DISPlay:TXPower:VIEW[1]:WINDow[1]:TRACe:Y[:SCALe]:RPOSition TOP CENTer BOTTom	300
:DISPlay:TXPower:VIEW[1]:WINDow[1]:TRACe:Y[:SCALe]:RPOSition?	300
:DISPlay:WAVeform:VIEW:NSElect <integer>	987
:DISPlay:WAVeform:VIEW:NSElect?	987
:DISPlay:WAVeform:VIEW[:SElect] RFENvelope IQ	987
:DISPlay:WAVeform:VIEW[:SElect]?	987
:DISPlay:WAVeform:VIEW[1]:WINDow[1]:TRACe:Y[:SCALe]:PDIVision <rel_ampl>	935
:DISPlay:WAVeform:VIEW[1]:WINDow[1]:TRACe:Y[:SCALe]:PDIVision?	935
:DISPlay:WAVeform:VIEW[1]:WINDow[1]:TRACe:Y[:SCALe]:RLEVel <ampl>	933
:DISPlay:WAVeform:VIEW[1]:WINDow[1]:TRACe:Y[:SCALe]:RLEVel?	933
:DISPlay:WAVeform:VIEW[1]:WINDow[1]:TRACe:Y[:SCALe]:RPOSition TOP CENTer BOTTom	937
:DISPlay:WAVeform:VIEW[1]:WINDow[1]:TRACe:Y[:SCALe]:RPOSition?	937
:DISPlay:WAVeform:VIEW[1]2:WINDow[1]:TRACe:X[:SCALe]:COUPle 0 1 OFF ON	983
:DISPlay:WAVeform:VIEW[1]2:WINDow[1]:TRACe:X[:SCALe]:COUPle?	983
:DISPlay:WAVeform:VIEW[1]2:WINDow[1]:TRACe:X[:SCALe]:PDIVision <time>	982
:DISPlay:WAVeform:VIEW[1]2:WINDow[1]:TRACe:X[:SCALe]:PDIVision?	982
:DISPlay:WAVeform:VIEW[1]2:WINDow[1]:TRACe:X[:SCALe]:RLEVel <time>	981
:DISPlay:WAVeform:VIEW[1]2:WINDow[1]:TRACe:X[:SCALe]:RLEVel?	981
:DISPlay:WAVeform:VIEW[1]2:WINDow[1]:TRACe:X[:SCALe]:RPOSition LEFT CENTer RIGHT	982
:DISPlay:WAVeform:VIEW[1]2:WINDow[1]:TRACe:X[:SCALe]:RPOSition?	982
:DISPlay:WAVeform:VIEW[1]2:WINDow[1]:TRACe:Y[:SCALe]:COUPle 0 1 OFF ON	938
:DISPlay:WAVeform:VIEW[1]2:WINDow[1]:TRACe:Y[:SCALe]:COUPle?	938
:DISPlay:WAVeform:VIEW2:WINDow[1]:TRACe:Y[:SCALe]:PDIVision <voltage>	936
:DISPlay:WAVeform:VIEW2:WINDow[1]:TRACe:Y[:SCALe]:PDIVision?	936
:DISPlay:WAVeform:VIEW2:WINDow[1]:TRACe:Y[:SCALe]:RLEVel <voltage>	934
:DISPlay:WAVeform:VIEW2:WINDow[1]:TRACe:Y[:SCALe]:RLEVel?	934
:DISPlay:WAVeform:VIEW2:WINDow[1]:TRACe:Y[:SCALe]:RPOSition TOP CENTer BOTTom	938
:DISPlay:WAVeform:VIEW2:WINDow[1]:TRACe:Y[:SCALe]:RPOSition?	938
:DISPlay:WINDow:FORMat:TILE	131
:DISPlay:WINDow:FORMat:ZOOM	131

List of Commands

:DISPlay:WINDow[:SElect] <number>	131
:DISPlay:WINDow[:SElect]?	131
:DISPlay:WINDow[1]:ANNOtation[:ALL] OFF ON 0 1	1313
:DISPlay:WINDow[1]:ANNOtation[:ALL]?	1313
:DISPlay:WINDow[1]:TRACe:GRATICule:GRID[:STATe] OFF ON 0 1	1312
:DISPlay:WINDow[1]:TRACe:GRATICule:GRID[:STATe]?	1312
:DISPlay:WINDow[1]:TRACe:Y:DLINe <ampl>.	1312
:DISPlay:WINDow[1]:TRACe:Y:DLINe:STATe OFF ON 0 1	1312
:DISPlay:WINDow[1]:TRACe:Y:DLINe:STATe?.	1312
:DISPlay:WINDow[1]:TRACe:Y:DLINe?	1312
:FETCh:ACP[n]?	349
:FETCh:CDPower[n]?	749
:FETCh:MONitor[n]?	991
:FETCh:OBWidth [n]?	657
:FETCh:OBWidth:FERRor?	657
:FETCh:OBWidth:OBWidth?	657
:FETCh:OBWidth:XDB?	657
:FETCh:PStatic[n]?	707
:FETCh:PVTime[n]?	437
:FETCh:SEMAsk[n]?	493
:FETCh:SPURious[n]?	589
:FETCh:TXPower BPOWer[n]?	295
:FETCh:WAVeform[n]	931
:FORMat:BORDER NORMAl SWAPped	1142
:FORMat:BORDER?	1142
:FORMat[:TRACe][:DATA] ASCii INTEger,32 REAL,32 REAL,64.	1140
:FORMat[:TRACe][:DATA]?	1140
:INITiate:ACP	349
:INITiate:CDPower	749
:INITiate:CONTInuous OFF ON 0 1	1059
:INITiate:CONTInuous?	1059

List of Commands

:INITiate:MONitor	991
:INITiate:OBWidth	657
:INITiate:PAUSE	1236
:INITiate:PStatistic	707
:INITiate:PVTime	437
:INITiate:REStart	1201
:INITiate:RESume	1236
:INITiate:SEMask	493
:INITiate:SPURious	589
:INITiate:TXPower BPOwer	295
:INITiate:WAVEform	931
:INITiate[:IMMediate]	1201
:INPut:COUPling AC DC	1067
:INPut:COUPling:I Q DC LFR1 LFR2	1079
:INPut:COUPling:I Q?	1079
:INPut:COUPling?	1067
:INPut:IMPedance:IQ U50 B50 U1M B1M	1074
:INPut:IMPedance:IQ?	1074
:INPut:IMPedance:REference <integer>	1081
:INPut:IMPedance:REference?	1081
:INPut:IQ:MIRRored OFF ON 0 1	1075
:INPut:IQ:MIRRored?	1075
:INPut:IQ:Q:DIFFerential OFF ON 0 1	1075
:INPut:IQ:Q:DIFFerential?	1075
:INPut:IQ[:I]:DIFFerential OFF ON 0 1	1072
:INPut:IQ[:I]:DIFFerential?	1072
:INPut:OFFSet:I Q <voltage>	1079
:INPut:OFFSet:I Q?	1079
:INPut[1]:IQ:BALEnced[:STATe] OFF ON 0 1	1072
:INPut[1]:IQ:BALEnced[:STATe]?	1072
:INPut[1]:IQ:Q:IMPedance LOW HIGH	1076

List of Commands

:INPut[1]:IQ:Q:IMPedance?	1076
:INPut[1]:IQ:TYPE IQ I Q	1071
:INPut[1]:IQ:TYPE?	1071
:INPut[1]:IQ[:I]:IMPedance LOW HIGH	1073
:INPut[1]:IQ[:I]:IMPedance?	1073
:INSTrument:CATalog?	1147
:INSTrument:DEFault	198
:INSTrument:NSElect <integer>	1146
:INSTrument:NSElect?	1146
:INSTrument[:SElect] SA BASIC ADEMOD NFIGURE PNOISE CDMA2K TDSCDMA VSA VSA89601 WCD- MA WIMAXOFDMA EDGE GSM CDMA1XEV RLC	1145
:INSTrument[:SElect]?	1145
:LXI:CLOCK:PTP:ACCuracy NS25 NS100 NS250 NS1000 NS2500 US10 US25 US100 US250 US1000 US2500 MS10 MS25 MS100 MS1000 S 10 GT10S UNKNown	259
:LXI:CLOCK:PTP:ACCuracy?	259
:LXI:CLOCK:PTP:ANNounce:INTerval <interval>	260
:LXI:CLOCK:PTP:ANNounce:INTerval?	260
:LXI:CLOCK:PTP:ANNounce:RTOut <numberOfIntervals>	260
:LXI:CLOCK:PTP:ANNounce:RTOut?	260
:LXI:CLOCK:PTP:CCLass?	260
:LXI:CLOCK:PTP:DEViation?	261
:LXI:CLOCK:PTP:DOMain <domainNumber>	261
:LXI:CLOCK:PTP:DOMain?	261
:LXI:CLOCK:PTP:DRINterval <seconds>	263
:LXI:CLOCK:PTP:DRINterval?	263
:LXI:CLOCK:PTP:GMASter:ACCuracy?	264
:LXI:CLOCK:PTP:GMASter:MADDress?	264
:LXI:CLOCK:PTP:GMASter:TRACeability?	264
:LXI:CLOCK:PTP:MASter:MADDress?	264
:LXI:CLOCK:PTP:OFFSet?	261
:LXI:CLOCK:PTP:PRIority:FIRSt <priority>	261

List of Commands

:LXI:CLOCK:PTP:PRiority:FIRSt?	261
:LXI:CLOCK:PTP:PRiority:SECond <priority>	262
:LXI:CLOCK:PTP:PRiority:SECond?	262
:LXI:CLOCK:PTP:SINterval <seconds>	263
:LXI:CLOCK:PTP:SINterval?	263
:LXI:CLOCK:PTP:STATe?	262
:LXI:CLOCK:PTP:TRACeability?	262
:LXI:CLOCK:PTP:VARiance?	262
:LXI:CLOCK:SALGorithm:LOG:ALL?	266
:LXI:CLOCK:SALGorithm:LOG:CIRCular:FBENtry	265
:LXI:CLOCK:SALGorithm:LOG:CIRCular[:ENABled] ON OFF 0 1	265
:LXI:CLOCK:SALGorithm:LOG:CIRCular[:ENABled]?	265
:LXI:CLOCK:SALGorithm:LOG:CLEar.	265
:LXI:CLOCK:SALGorithm:LOG:COUNT?	266
:LXI:CLOCK:SALGorithm:LOG:ENABled ON OFF 0 1	266
:LXI:CLOCK:SALGorithm:LOG:ENABled?	266
:LXI:CLOCK:SALGorithm:LOG:ENTRy? <intIndex>	267
:LXI:CLOCK:SALGorithm:LOG:SIZE <maxLogEntries>	266
:LXI:CLOCK:SALGorithm:LOG:SIZE?	266
:LXI:CLOCK:SALGorithm:LOG:STATistics:CLEar	267
:LXI:CLOCK:SALGorithm:LOG:STATistics[:DATA]?	267
:LXI:CLOCK:SALGorithm:LOG[:NEXT]?	265
:LXI:CLOCK:SALGorithm[:SET]:ASYMmetry <seconds>	267
:LXI:CLOCK:SALGorithm[:SET]:ASYMmetry?	267
:LXI:CLOCK:SALGorithm[:SET]:CFTHreshold <secondsSquared>	268
:LXI:CLOCK:SALGorithm[:SET]:CFTHreshold?	268
:LXI:CLOCK:SALGorithm[:SET]:CIConstant <servoConstant>	269
:LXI:CLOCK:SALGorithm[:SET]:CIConstant?	269
:LXI:CLOCK:SALGorithm[:SET]:CONFigure <asymmetry>, <coarse fine threshold>, <cpc>, <cic>, <fpc>, <fic>, <maximum outlier discard>, <outlier threshold>, <set/steer threshold>	271
:LXI:CLOCK:SALGorithm[:SET]:CPConstant <servoConstant>	268

List of Commands

:LXI:CLOCK:SALGorithm[:SET]:CPConstant?	268
:LXI:CLOCK:SALGorithm[:SET]:FIConstant <servoConstant>	269
:LXI:CLOCK:SALGorithm[:SET]:FIConstant?	269
:LXI:CLOCK:SALGorithm[:SET]:FPConstant <servoConstant>	269
:LXI:CLOCK:SALGorithm[:SET]:FPConstant?	269
:LXI:CLOCK:SALGorithm[:SET]:OMAXimum <consecutiveSamples>.	270
:LXI:CLOCK:SALGorithm[:SET]:OMAXimum?	270
:LXI:CLOCK:SALGorithm[:SET]:OTENable ON OFF 1 0	271
:LXI:CLOCK:SALGorithm[:SET]:OTENable?	271
:LXI:CLOCK:SALGorithm[:SET]:OTHReshold <standardDeviations>.	270
:LXI:CLOCK:SALGorithm[:SET]:OTHReshold?	270
:LXI:CLOCK:SALGorithm[:SET]:STHReshold <seconds>	271
:LXI:CLOCK:SALGorithm[:SET]:STHReshold?	271
:LXI:CLOCK:SYNC:LOCAl:ENABled ON OFF 0 1	272
:LXI:CLOCK:SYNC:LOCAl:ENABled?	272
:LXI:CLOCK:SYNC:LOCAl:INTerval?	272
:LXI:CLOCK:SYNC:LOCAl:INTerval	272
:LXI:CLOCK:SYNC:MASTer?	271
:LXI:CLOCK[:TIME]:DLSavings?	257
:LXI:CLOCK[:TIME]:FRACtion <fraction>	255
:LXI:CLOCK[:TIME]:FRACtion?	255
:LXI:CLOCK[:TIME]:LOCAl?	256
:LXI:CLOCK[:TIME]:LSOFFset <integer>	256
:LXI:CLOCK[:TIME]:LSOFFset?	256
:LXI:CLOCK[:TIME]:MARKer[1] 2 3 4 5 6 7 8 9:CLEAr	257
:LXI:CLOCK[:TIME]:MARKer[1] 2 3 4 5 6 7 8 9:DELTA?	258
:LXI:CLOCK[:TIME]:MARKer[1] 2 3 4 5 6 7 8 9[:SET]	257
:LXI:CLOCK[:TIME]:MEASure:CLEAr	259
:LXI:CLOCK[:TIME]:MEASure[:DELTA]?	258
:LXI:CLOCK[:TIME]:SECONds <seconds>.	255
:LXI:CLOCK[:TIME]:SECONds?	255

List of Commands

:LXI:CLOCK[:TIME]:TAI?	256
:LXI:CLOCK[:TIME]:TZONe?	256
:LXI:CLOCK[:TIME]:UTC?	257
:LXI:CLOCK[:TIME][:VALue] <seconds>,<fractionalSeconds>	254
:LXI:CLOCK[:TIME][:VALue]?	254
:LXI:EVENT:DOMain <intDomain>	247
:LXI:EVENT:DOMain?	247
:LXI:EVENT:INPut:LAN:ADD "LANEVENT"	274
:LXI:EVENT:INPut:LAN:COUNt?	277
:LXI:EVENT:INPut:LAN:DISable:ALL	273
:LXI:EVENT:INPut:LAN:FILTer "LANEVENT","filterString"	275
:LXI:EVENT:INPut:LAN:FILTer?	275
:LXI:EVENT:INPut:LAN:IDENtifier "LANEVENT","identifier"	275
:LXI:EVENT:INPut:LAN:IDENtifier? "LANEVENT"	275
:LXI:EVENT:INPut:LAN:LIST?	277
:LXI:EVENT:INPut:LAN:LOCation "LANEVENT","path"	273
:LXI:EVENT:INPut:LAN:LOCation? "LANEVENT"	273
:LXI:EVENT:INPut:LAN:REMove:ALL	274
:LXI:EVENT:INPut:LAN:REMove[:EVENT] "LANEVENT"	274
:LXI:EVENT:INPut:LAN[:SET]:CONFigure "lanEvent", <enab>, <detection>, <filter>, <identifier>	278
:LXI:EVENT:INPut:LAN[:SET]:DETection "LANEVENT", HIGH LOW RISE FALL	276
:LXI:EVENT:INPut:LAN[:SET]:DETection? "LANEVENT"	276
:LXI:EVENT:INPut:LAN[:SET]:ENABled "LANEVENT",ON OFF 1 0	277
:LXI:EVENT:INPut:LAN[:SET]:ENABled? "LANEVENT"	277
:LXI:EVENT:LOG:ALL?	211
:LXI:EVENT:LOG:CIRCular:FBENtry	212
:LXI:EVENT:LOG:CIRCular[:ENABle] ON OFF 1 0	210
:LXI:EVENT:LOG:CIRCular[:ENABle]?	210
:LXI:EVENT:LOG:CLEar	210
:LXI:EVENT:LOG:COUNt?	211
:LXI:EVENT:LOG:ENABle ON OFF 1 0	210

List of Commands

:LXI:EVENT:LOG:ENABLE?	210
:LXI:EVENT:LOG:ENTRY? <intIndex>	211
:LXI:EVENT:LOG:SIZE <size>	210
:LXI:EVENT:LOG:SIZE?	210
:LXI:EVENT:LOG[:NEXT]?	211
:LXI:EVENT:STATus[:ENABled] "STATUSEVENT",ON OFF 1 0	272
:LXI:EVENT:STATus[:ENABled]? "STATUSEVENT"	273
:LXI:EVENT[:OUTPut]:LAN:ADD "LANEVENT"	248
:LXI:EVENT[:OUTPut]:LAN:COUNt?	253
:LXI:EVENT[:OUTPut]:LAN:DISable:ALL	247
:LXI:EVENT[:OUTPut]:LAN:LIST?	248
:LXI:EVENT[:OUTPut]:LAN:REMOve:ALL	249
:LXI:EVENT[:OUTPut]:LAN:REMOve[:EVENT] "LANEVENT"	248
:LXI:EVENT[:OUTPut]:LAN:SEND "LANEVENT", RISE FALL	253
:LXI:EVENT[:OUTPut]:LAN[:SET]:CONFigure "lanEvent",<enabled>,<source>,<slope>,<drive>,<destination> 253	
:LXI:EVENT[:OUTPut]:LAN[:SET]:DESTination "LANEVENT", "destinationExpression"	250
:LXI:EVENT[:OUTPut]:LAN[:SET]:DESTination? "LANEVENT"	250
:LXI:EVENT[:OUTPut]:LAN[:SET]:DRIVE "LANEVENT", OFF NORMAL WOR.	251
:LXI:EVENT[:OUTPut]:LAN[:SET]:DRIVE? "LANEVENT"	251
:LXI:EVENT[:OUTPut]:LAN[:SET]:ENABled "LANEVENT",ON OFF 1 0	253
:LXI:EVENT[:OUTPut]:LAN[:SET]:ENABled? "LANEVENT"	253
:LXI:EVENT[:OUTPut]:LAN[:SET]:IDENTifier "LANEVENT", "identifier"	254
:LXI:EVENT[:OUTPut]:LAN[:SET]:IDENTifier? "LANEVENT"	254
:LXI:EVENT[:OUTPut]:LAN[:SET]:SLOPe "LANEVENT", POSitive NEGative	252
:LXI:EVENT[:OUTPut]:LAN[:SET]:SLOPe? "LANEVENT"	252
:LXI:EVENT[:OUTPut]:LAN[:SET]:SOURce "LANEVENT", "SourceEvent"	250
:LXI:EVENT[:OUTPut]:LAN[:SET]:SOURce? "LANEVENT"	250
:LXI:EVENT[:OUTPut]:LAN[:SET]:TSDelta "LANEVENT", <seconds>	252
:LXI:EVENT[:OUTPut]:LAN[:SET]:TSDelta? "LANEVENT"	252
:MEASure:ACP[n]?	349

List of Commands

:MEASure:CDPower[n]?	749
:MEASure:MONitor[n]?	991
:MEASure:OBWidth [n]?	657
:MEASure:OBWidth:FERRor?	657
:MEASure:OBWidth:OBWidth?	657
:MEASure:OBWidth:XDB?	657
:MEASure:PVTime[n]?	437
:MEASure:SEMask[n]?	493
:MEASure:SPURious[n]?	589
:MEASure:TXPower BPOWer[n]?	295
:MEASure:WAVEform[n].	931
:MMEMory:LOAD:CAPTured <filename>	1196
:MMEMory:LOAD:CORRection 1 2 3 4, <filename>	1195
:MMEMory:LOAD:LIMit LLINE1 LLINE2,<filename>	1196
:MMEMory:LOAD:RECOrding <filename>	1197
:MMEMory:LOAD:STATe <filename>	1182
:MMEMory:LOAD:TRACe TRACE1 TRACE2 TRACE3 TRACE4 TRACE5 TRACE6,<filename>	1186
:MMEMory:LOAD:TRACe:DATA D1 D2 D3 D4 D5 D6,<filename>[,CSV TXT SDF]	1195
:MMEMory:LOAD:TRACe:DATA TRACE1 TRACE2 TRACE3 TRACE4 TRACE5 TRACE6,<filename>	1194
:MMEMory:LOAD:TRACe:REGister TRACE1 TRACE2 TRACE3 TRACE4 TRACE5 TRACE6,<integer>	1186
:MMEMory:LOAD:ZMAP <filename>	1197
:MMEMory:STORE:CAPTured <filename>	1219
:MMEMory:STORE:CORRection 1 2 3 4, <filename>	1218
:MMEMory:STORE:LIMit LLINE1 LLINE2,<filename>	1219
:MMEMory:STORE:RECOrding <filename>[,SDF SD- FX CSV TXT MAT4 MAT HDF5 BIN[,OFF ON 0 1[,OFF ON 0 1[,OFF ON 0 1]]]	1220
:MMEMory:STORE:RESults <filename>	1217
:MMEMory:STORE:RESults:MTABLE PTABLE <filename>	1217
:MMEMory:STORE:SCReen <filename>	1224
:MMEMory:STORE:SCReen:THEMe TDColor TDMonochrome FCOLOR FMONochrome	1223
:MMEMory:STORE:SCReen:THEMe?	1223

List of Commands

:MMEMory:STORe:STATe <filename>	1206
:MMEMory:STORe:TRACe TRACE1 TRACE2 TRACE3 TRACE4 TRACE5 TRACE6 ALL,<filename> ..	1209
:MMEMory:STORe:TRACe:DATA TRACE1 TRACE2 TRACE3 TRACE4 TRACE5 TRACE6,"<filena- me>"[,CSV TXT SDF[,OFF ON 0 1]]	1219
:MMEMory:STORe:TRACe:DATA TRACE1 TRACE2 TRACE3 TRACE4 TRACE5 TRACE6 ALL,<filename>. 1218	
:MMEMory:STORe:TRACe:REGister TRACE1 TRACE2 TRACE3 TRACE4 TRACE5 TRACE6 ALL,<integer> 1209	
:MMEMory:STORe:ZMAP <filename>	1220
:OUTPut:DBUS[1][:STATe] ON OFF 1 0	1108
:OUTPut:DBUS[1][:STATe]?	1108
:OUTPut:IQ:OUTPut IQ1 IQ250 OFF	1108
:OUTPut:IQ:OUTPut?	1108
:READ:ACP[n]?	349
:READ:CDPower[n]?	749
:READ:MONitor[n]?	991
:READ:OBWidth [n]?	657
:READ:OBWidth:FERRor?	657
:READ:OBWidth:OBWidth?	657
:READ:OBWidth:XDB?	657
:READ:PSTatistic[n]?	707
:READ:PVTime[n]?	437
:READ:SEMAsk[n]?	493
:READ:SPURious[n]?	589
:READ:TXPower BPOWER[n]?	295
:READ:WAVEform[n]	931
:STATus:OPERation:CONDition?	157
:STATus:OPERation:ENABle <integer>	158
:STATus:OPERation:ENABle?	158
:STATus:OPERation:NTRansition <integer>	159
:STATus:OPERation:NTRansition?	159
:STATus:OPERation:PTRansition <integer>	159

List of Commands

:STATUS:OPERation:PTRansition?	159
:STATUS:OPERation[:EVENT]?	158
:STATUS:PRESet	160
:STATUS:QUEStionable:CALibration:CONDition?	163
:STATUS:QUEStionable:CALibration:ENABle <integer>	163
:STATUS:QUEStionable:CALibration:ENABle?	163
:STATUS:QUEStionable:CALibration:EXTended:FAILure:CONDition?	167
:STATUS:QUEStionable:CALibration:EXTended:FAILure:ENABle <integer>	168
:STATUS:QUEStionable:CALibration:EXTended:FAILure:ENABle?	168
:STATUS:QUEStionable:CALibration:EXTended:FAILure:NTRansition <integer>	169
:STATUS:QUEStionable:CALibration:EXTended:FAILure:NTRansition?	169
:STATUS:QUEStionable:CALibration:EXTended:FAILure:PTRansition <integer>	169
:STATUS:QUEStionable:CALibration:EXTended:FAILure:PTRansition?	169
:STATUS:QUEStionable:CALibration:EXTended:FAILure[:EVENT]?	168
:STATUS:QUEStionable:CALibration:EXTended:NEEDed:CONDition?	170
:STATUS:QUEStionable:CALibration:EXTended:NEEDed:ENABle <integer>	170
:STATUS:QUEStionable:CALibration:EXTended:NEEDed:ENABle?	170
:STATUS:QUEStionable:CALibration:EXTended:NEEDed:NTRansition <integer>	171
:STATUS:QUEStionable:CALibration:EXTended:NEEDed:NTRansition?	171
:STATUS:QUEStionable:CALibration:EXTended:NEEDed:PTRansition <integer>	172
:STATUS:QUEStionable:CALibration:EXTended:NEEDed:PTRansition?	172
:STATUS:QUEStionable:CALibration:EXTended:NEEDed[:EVENT]?	171
:STATUS:QUEStionable:CALibration:NTRansition <integer>	164
:STATUS:QUEStionable:CALibration:NTRansition?	164
:STATUS:QUEStionable:CALibration:PTRansition <integer>	164
:STATUS:QUEStionable:CALibration:PTRansition?	164
:STATUS:QUEStionable:CALibration:SKIPped:CONDition?	165
:STATUS:QUEStionable:CALibration:SKIPped:ENABle <integer>	165
:STATUS:QUEStionable:CALibration:SKIPped:ENABle?	165
:STATUS:QUEStionable:CALibration:SKIPped:NTRansition <integer>	166
:STATUS:QUEStionable:CALibration:SKIPped:NTRansition?	166

List of Commands

:STATus:QUEStionable:CALibration:SKIPped:PTRansition <integer>	167
:STATus:QUEStionable:CALibration:SKIPped:PTRansition?	167
:STATus:QUEStionable:CALibration:SKIPped[:EVENT]?	166
:STATus:QUEStionable:CALibration[:EVENT]?	163
:STATus:QUEStionable:CONDition?	160
:STATus:QUEStionable:ENABle 16 Sets the register so that temperature summary will be reported to the Status Byte Register	161
:STATus:QUEStionable:ENABle?	161
:STATus:QUEStionable:FREQuency:CONDition?	172
:STATus:QUEStionable:FREQuency:ENABle <integer>	172
:STATus:QUEStionable:FREQuency:ENABle?	172
:STATus:QUEStionable:FREQuency:NTRansition <integer>.	173
:STATus:QUEStionable:FREQuency:NTRansition?	173
:STATus:QUEStionable:FREQuency:PTRansition <integer>	174
:STATus:QUEStionable:FREQuency:PTRansition?	174
:STATus:QUEStionable:FREQuency[:EVENT]?	173
:STATus:QUEStionable:INTegrity:CONDition?	174
:STATus:QUEStionable:INTegrity:ENABle <integer>	175
:STATus:QUEStionable:INTegrity:ENABle?	175
:STATus:QUEStionable:INTegrity:NTRansition <integer>.	176
:STATus:QUEStionable:INTegrity:NTRansition?	176
:STATus:QUEStionable:INTegrity:PTRansition <integer>	176
:STATus:QUEStionable:INTegrity:PTRansition?	176
:STATus:QUEStionable:INTegrity:SIGNal:CONDition?	177
:STATus:QUEStionable:INTegrity:SIGNal:ENABle <integer>	177
:STATus:QUEStionable:INTegrity:SIGNal:ENABle?	177
:STATus:QUEStionable:INTegrity:SIGNal:NTRansition <integer>	178
:STATus:QUEStionable:INTegrity:SIGNal:NTRansition?	178
:STATus:QUEStionable:INTegrity:SIGNal:PTRansition <integer>	178
:STATus:QUEStionable:INTegrity:SIGNal:PTRansition?	178
:STATus:QUEStionable:INTegrity:SIGNal[:EVENT]?	178

List of Commands

:STATUS:QUESTIONable:INTEGRity:UNCalibrated:CONDition?	179
:STATUS:QUESTIONable:INTEGRity:UNCalibrated:ENABLE?	179
:STATUS:QUESTIONable:INTEGRity:UNCalibrated:ENABLE	179
:STATUS:QUESTIONable:INTEGRity:UNCalibrated:NTRANSition <integer>	180
:STATUS:QUESTIONable:INTEGRity:UNCalibrated:NTRANSition?	180
:STATUS:QUESTIONable:INTEGRity:UNCalibrated:PTRANSition <integer>	181
:STATUS:QUESTIONable:INTEGRity:UNCalibrated:PTRANSition?	181
:STATUS:QUESTIONable:INTEGRity[:EVENT]?	180
:STATUS:QUESTIONable:INTEGRity[:EVENT]?	175
:STATUS:QUESTIONable:NTRANSition 16 Temperature summary 'questionable cleared' will be reported to the Status Byte Register.	162
:STATUS:QUESTIONable:NTRANSition?	162
:STATUS:QUESTIONable:POWER:CONDition?	181
:STATUS:QUESTIONable:POWER:ENABLE <integer>	182
:STATUS:QUESTIONable:POWER:ENABLE?	182
:STATUS:QUESTIONable:POWER:NTRANSition <integer>	183
:STATUS:QUESTIONable:POWER:NTRANSition?	183
:STATUS:QUESTIONable:POWER:PTRANSition <integer>	183
:STATUS:QUESTIONable:POWER:PTRANSition?>	183
:STATUS:QUESTIONable:POWER[:EVENT]?	182
:STATUS:QUESTIONable:PTRANSition <integer>	162
:STATUS:QUESTIONable:PTRANSition?	162
:STATUS:QUESTIONable:TEMPERature:CONDition?	184
:STATUS:QUESTIONable:TEMPERature:ENABLE <integer>	184
:STATUS:QUESTIONable:TEMPERature:ENABLE?	184
:STATUS:QUESTIONable:TEMPERature:NTRANSition <integer>	185
:STATUS:QUESTIONable:TEMPERature:NTRANSition?	185
:STATUS:QUESTIONable:TEMPERature:PTRANSition <integer>	185
:STATUS:QUESTIONable:TEMPERature:PTRANSition?	185
:STATUS:QUESTIONable:TEMPERature[:EVENT]?	185
:STATUS:QUESTIONable[:EVENT]?	161

List of Commands

:SYSTem:APPLication:CATalog:OPTion? <model>	1150
:SYSTem:APPLication:CATalog:REVision? <model>	1149
:SYSTem:APPLication:CATalog[:NAME]:COUNT?	1149
:SYSTem:APPLication:CATalog[:NAME]?	1149
:SYSTem:APPLication[:CURRent]:OPTion?	1148
:SYSTem:APPLication[:CURRent]:REVision?	1148
:SYSTem:APPLication[:CURRent][:NAME]?	1147
:SYSTem:AUService:DATE?	285
:SYSTem:COMMunicate:GPIB[1][:SELF]:ADDRess <integer>	241
:SYSTem:COMMunicate:GPIB[1][:SELF]:ADDRess?	241
:SYSTem:COMMunicate:GPIB[1][:SELF]:CONTRoller[:ENABle] ON OFF 0 1	242
:SYSTem:COMMunicate:GPIB[1][:SELF]:CONTRoller[:ENABle]?	242
:SYSTem:COMMunicate:LAN:SCPI:SICL:ENABle OFF ON 0 1	245
:SYSTem:COMMunicate:LAN:SCPI:SICL:ENABle?	245
:SYSTem:COMMunicate:LAN:SCPI:SOCKet:CONTrol?	244
:SYSTem:COMMunicate:LAN:SCPI:SOCKet:ENABle OFF ON 0 1	243
:SYSTem:COMMunicate:LAN:SCPI:SOCKet:ENABle?	243
:SYSTem:COMMunicate:LAN:SCPI:TELNet:ENABle OFF ON 0 1	243
:SYSTem:COMMunicate:LAN:SCPI:TELNet:ENABle?	243
:SYSTem:COMMunicate:USB:CONNecTion?	245
:SYSTem:COMMunicate:USB:PACKets?	246
:SYSTem:COMMunicate:USB:STATus?	245
:SYSTem:DATE “<year>,<month>,<day>”	291
:SYSTem:DATE?	291
:SYSTem:DEFault [ALL] ALIGn INPut MISC MODes PON	278
:SYSTem:ERRor:VERBose OFF ON 0 1	206
:SYSTem:ERRor:VERBose?	206
:SYSTem:ERRor[:NEXT]?	205
:SYSTem:HELP:HEADers?	290
:SYSTem:HID?	284
:SYSTem:KLOCK OFF ON 0 1	290

List of Commands

:SYSTem:KLOCK?	290
:SYSTem:LKEY <"OptionInfo">, <"LicenseInfo">	283
:SYSTem:LKEY:DELEte <"OptionInfo">,<"LicenseInfo">	283
:SYSTem:LKEY:LIST?	284
:SYSTem:LKEY? <"OptionInfo">	284
:SYSTem:MRElay:COUnT?	287
:SYSTem:OPTions?	289
:SYSTem:PON:APPLication:LLISt <string of INSTrument:SELEct names>	216
:SYSTem:PON:APPLication:LLISt?	216
:SYSTem:PON:APPLication:VMEMory:TOTal?	216
:SYSTem:PON:APPLication:VMEMory:USED:NAME? <INSTrument:SELEct name>	217
:SYSTem:PON:APPLication:VMEMory:USED?	217
:SYSTem:PON:APPLication:VMEMory[::AVAILable]?	216
:SYSTem:PON:ETIME?	288
:SYSTem:PON:MODE SA BASIC ADEMOD NFIGURE PNOISE CDMA2K TDSCDMA VSA VSA89601 WCDMA WIMAXOFDMA	214
:SYSTem:PON:MODE?	214
:SYSTem:PON:TIME?	230
:SYSTem:PON:TYPE MODE USER LAST PRESet	212
:SYSTem:PON:TYPE?	212
:SYSTem:PRESet.	196
:SYSTem:PRESet:USER	293
:SYSTem:PRESet:USER:ALL	293
:SYSTem:PRESet:USER:SAVE	294
:SYSTem:PRINt:THEMe TDColor TDMonochrome FCOLOR FMONochrome.	194
:SYSTem:PRINt:THEMe?	194
:SYSTem:PUP:PROcEss	215
:SYSTem:SHOW OFF ERRor SYSTem HARDware LXI HWStatIstIcs ALIGNment SOFTware	204
:SYSTem:SHOW?	204
:SYSTem:TEMPerature:HEXTreme?	288
:SYSTem:TEMPerature:LEXTreme?	288

List of Commands

:SYSTem:TIME “<hour>,<minute>,<second>”	291
:SYSTem:TIME?	291
:SYSTem:VERSion?	290
:TRACe:ACPower[:TRACe1 2 3]:TYPE WRITe AVERAge MAXHold MINHold.	424
:TRACe:ACPower[:TRACe1 2 3]:TYPE?	424
:TRACe:MONitor:CLEar [TRACE1 TRACE2 TRACE3	1032
:TRACe:MONitor:CLEar:ALL	1032
:TRACe:OBWidth:TYPE WRITe AVERAge MAXHold MINHold.	699
:TRACe:OBWidth:TYPE?	699
:TRACe:SEMask:TYPE WRITe AVERAge MAXHold MINHold.	562
:TRACe:SEMask:TYPE?	562
:TRACe[1] 2 3:ACPower:DISPlay[:STATe] ON OFF 0 1	428
:TRACe[1] 2 3:ACPower:DISPlay[:STATe]?	428
:TRACe[1] 2 3:ACPower:TYPE WRITe AVERAge MAXHold MINHold	424
:TRACe[1] 2 3:ACPower:TYPE?	424
:TRACe[1] 2 3:ACPower:UPDate[:STATe] ON OFF 0 1	428
:TRACe[1] 2 3:ACPower:UPDate[:STATe]?	428
:TRACe[1] 2 3:MONitor:DISPlay[:STATe] ON OFF 0 1	1029
:TRACe[1] 2 3:MONitor:DISPlay[:STATe]?	1029
:TRACe[1] 2 3:MONitor:TYPE WRITe AVERAge MAXHold MINHold.	1028
:TRACe[1] 2 3:MONitor:TYPE?	1028
:TRACe[1] 2 3:MONitor:UPDate[:STATe] ON OFF 0 1	1029
:TRACe[1] 2 3:MONitor:UPDate[:STATe]?	1029
:TRIGger:<measurement>[:SEQuence]:IQ:SOURce EXTernal1 EXTernal2 IMMediate IQMag IDEMod QDE- Mod IINPut QINPut AIQMag	1259
:TRIGger:<measurement>[:SEQuence]:IQ:SOURce?	1259
:TRIGger:<measurement>[:SEQuence]:RF:SOURce EXTernal1 EXTernal2 IMMediate LINE FRAME RF- Burst VIDeo IF ALARm LAN	1257
:TRIGger:<measurement>[:SEQuence]:RF:SOURce?	1257
:TRIGger:<measurement>[:SEQuence]:SOURce EXTernal1 EXTernal2 IMMediate LINE FRAME RFBurst VID- eo IF ALARm LAN IQMag IDEMod QDEMod IINPut QINPut AIQMag	1253
:TRIGger:<measurement>[:SEQuence]:SOURce?	1253

List of Commands

:TRIGger:CDPower[:SEQuence]:IQ:SOURce IMMEDIATE EXternal[1] EXternal2 IQMag IDEMod QDEMod IIN- Put QINPut AIQMag	822
:TRIGger:CDPower[:SEQuence]:IQ:SOURce?	822
:TRIGger:CDPower[:SEQuence]:RF:SOURce IMMEDIATE EXternal[1] EXternal2 RFBurst VIDeo	822
:TRIGger:CDPower[:SEQuence]:RF:SOURce?	822
:TRIGger:CDPower[:SEQuence]:SOURce EXternal[1] EXternal2 IMMEDIATE RFBurst VIDeo IQMag IDEM- od QDEMod IINPut QINPut AIQMag	821
:TRIGger:CDPower[:SEQuence]:SOURce?	821
:TRIGger:EVM[:SEQuence]:IQ:SOURce IMMEDIATE EXternal[1] EXternal2 IQMag IDEMod QDEMod IIN- Put QINPut AIQMag	905
:TRIGger:EVM[:SEQuence]:IQ:SOURce?	905
:TRIGger:EVM[:SEQuence]:RF:SOURce IMMEDIATE EXternal[1] EXternal2 RFBurst VIDeo	905
:TRIGger:EVM[:SEQuence]:RF:SOURce?	905
:TRIGger:EVM[:SEQuence]:SOURce EXternal[1] EXternal2 IMMEDIATE RFBurst VIDeo IQMag IDEM- od QDEMod IINPut QINPut AIQMag	904
:TRIGger:EVM[:SEQuence]:SOURce?	904
:TRIGger:PVTime[:SEQuence]:SOURce IMMEDIATE IF VIDeo EXternal[1] EXternal2 RFBurst	486
:TRIGger:PVTime[:SEQuence]:SOURce?	486
:TRIGger[:SEQuence]:AIQMag:BAWdth <freq>	1303
:TRIGger[:SEQuence]:AIQMag:BAWdth?	1303
:TRIGger[:SEQuence]:AIQMag:CENTer <freq>	1303
:TRIGger[:SEQuence]:AIQMag:CENTer?	1303
:TRIGger[:SEQuence]:AIQMag:DELay <time>	1302
:TRIGger[:SEQuence]:AIQMag:DELay:STATe OFF ON 0 1	1302
:TRIGger[:SEQuence]:AIQMag:DELay:STATe?	1302
:TRIGger[:SEQuence]:AIQMag:DELay?	1302
:TRIGger[:SEQuence]:AIQMag:LEVel <ampl >	1301
:TRIGger[:SEQuence]:AIQMag:LEVel?	1301
:TRIGger[:SEQuence]:AIQMag:SLOPe POSitive NEGative	1302
:TRIGger[:SEQuence]:AIQMag:SLOPe?	1302
:TRIGger[:SEQuence]:ATRigger <time>	1304
:TRIGger[:SEQuence]:ATRigger:STATe OFF ON 0 1	1304

List of Commands

:TRIGger[:SEQuence]:ATRigger:STATe?	1304
:TRIGger[:SEQuence]:ATRigger?	1304
:TRIGger[:SEQuence]:EXTernal1:DELay <time>	1266
:TRIGger[:SEQuence]:EXTernal1:DELay:STATe OFF ON 0 1	1266
:TRIGger[:SEQuence]:EXTernal1:DELay:STATe?	1266
:TRIGger[:SEQuence]:EXTernal1:DELay?	1266
:TRIGger[:SEQuence]:EXTernal1:LEVel <level>	1265
:TRIGger[:SEQuence]:EXTernal1:LEVel?	1265
:TRIGger[:SEQuence]:EXTernal1:SLOPe POSitive NEGative	1266
:TRIGger[:SEQuence]:EXTernal1:SLOPe?	1266
:TRIGger[:SEQuence]:EXTernal2:DELay <time>	1268
:TRIGger[:SEQuence]:EXTernal2:DELay:STATe OFF ON 0 1	1268
:TRIGger[:SEQuence]:EXTernal2:DELay:STATe?	1268
:TRIGger[:SEQuence]:EXTernal2:DELay?	1268
:TRIGger[:SEQuence]:EXTernal2:LEVel	1267
:TRIGger[:SEQuence]:EXTernal2:LEVel?	1267
:TRIGger[:SEQuence]:EXTernal2:SLOPe POSitive NEGative	1268
:TRIGger[:SEQuence]:EXTernal2:SLOPe?	1268
:TRIGger[:SEQuence]:FRAMe:ADJust <time>	1274
:TRIGger[:SEQuence]:FRAMe:DELay <time>	1277
:TRIGger[:SEQuence]:FRAMe:DELay:STATe OFF ON 0 1	1277
:TRIGger[:SEQuence]:FRAMe:DELay:STATe?	1277
:TRIGger[:SEQuence]:FRAMe:DELay?	1277
:TRIGger[:SEQuence]:FRAMe:OFFSet <time>	1274
:TRIGger[:SEQuence]:FRAMe:OFFSet:DISPlay:RESet	1275
:TRIGger[:SEQuence]:FRAMe:OFFSet?	1274
:TRIGger[:SEQuence]:FRAMe:PERiod <time>	1273
:TRIGger[:SEQuence]:FRAMe:PERiod?	1273
:TRIGger[:SEQuence]:FRAMe:SYNC EXTernal1 EXTernal2 RFBurst OFF	1276
:TRIGger[:SEQuence]:FRAMe:SYNC:HOLDoff <time>	1278
:TRIGger[:SEQuence]:FRAMe:SYNC:HOLDoff:STATe OFF ON 0 1	1278

List of Commands

:TRIGger[:SEQuence]:FRAMe:SYNC:HOLDoff:STATe?	1278
:TRIGger[:SEQuence]:FRAMe:SYNC:HOLDoff?	1278
:TRIGger[:SEQuence]:FRAMe:SYNC?	1276
:TRIGger[:SEQuence]:HOLDoff <time>	1305
:TRIGger[:SEQuence]:HOLDoff:STATe OFF ON 0 1	1305
:TRIGger[:SEQuence]:HOLDoff:STATe?	1305
:TRIGger[:SEQuence]:HOLDoff:TYPE NORMAl ABOVe BELow	1306
:TRIGger[:SEQuence]:HOLDoff:TYPE?	1306
:TRIGger[:SEQuence]:HOLDoff?	1305
:TRIGger[:SEQuence]:IDEMod:DELay <time>	1297
:TRIGger[:SEQuence]:IDEMod:DELay:STATe OFF ON 0 1	1297
:TRIGger[:SEQuence]:IDEMod:DELay:STATe?	1297
:TRIGger[:SEQuence]:IDEMod:DELay?	1297
:TRIGger[:SEQuence]:IDEMod:LEVel <voltage>	1296
:TRIGger[:SEQuence]:IDEMod:LEVel?	1296
:TRIGger[:SEQuence]:IDEMod:SLOPe POSitive NEGative	1296
:TRIGger[:SEQuence]:IDEMod:SLOPe?	1296
:TRIGger[:SEQuence]:IINPut:DELay <time>	1299
:TRIGger[:SEQuence]:IINPut:DELay:STATe OFF ON 0 1	1299
:TRIGger[:SEQuence]:IINPut:DELay:STATe?	1299
:TRIGger[:SEQuence]:IINPut:DELay?	1299
:TRIGger[:SEQuence]:IINPut:LEVel <voltage>	1299
:TRIGger[:SEQuence]:IINPut:LEVel?	1299
:TRIGger[:SEQuence]:IINPut:SLOPe POSitive NEGative	1299
:TRIGger[:SEQuence]:IINPut:SLOPe?	1299
:TRIGger[:SEQuence]:IQMag:DELay <time>	1295
:TRIGger[:SEQuence]:IQMag:DELay:STATe OFF ON 0 1	1295
:TRIGger[:SEQuence]:IQMag:DELay:STATe?	1295
:TRIGger[:SEQuence]:IQMag:DELay?	1295
:TRIGger[:SEQuence]:IQMag:LEVel <ampl >	1295
:TRIGger[:SEQuence]:IQMag:LEVel?	1295

List of Commands

:TRIGger[:SEquence]:IQMag:SLOPe POSitive NEGative	1295
:TRIGger[:SEquence]:IQMag:SLOPe?	1295
:TRIGger[:SEquence]:LINE:DELay <time>	1264
:TRIGger[:SEquence]:LINE:DELay:STATe OFF ON 0 1	1264
:TRIGger[:SEquence]:LINE:DELay:STATe?	1264
:TRIGger[:SEquence]:LINE:DELay?	1264
:TRIGger[:SEquence]:LINE:SLOPe POSitive NEGative	1264
:TRIGger[:SEquence]:LINE:SLOPe?	1264
:TRIGger[:SEquence]:LXI:ALARm:DISable:ALL	1285
:TRIGger[:SEquence]:LXI:ALARm:LIST?	1286
:TRIGger[:SEquence]:LXI:ALARm[:SET]:CONFigure "alarmEvent", <enable>, <epochSeconds>, <epochFraction>, <period>, <repeat>	1294
:TRIGger[:SEquence]:LXI:ALARm[:SET]:ENABled "alarmEvent",ON OFF 1 0	1293
:TRIGger[:SEquence]:LXI:ALARm[:SET]:ENABled? "alarmEvent"	1293
:TRIGger[:SEquence]:LXI:ALARm[:SET]:PERiod "alarmEvent",<seconds>	1291
:TRIGger[:SEquence]:LXI:ALARm[:SET]:PERiod? "alarmEvent"	1292
:TRIGger[:SEquence]:LXI:ALARm[:SET]:REPeat "alarmEvent",<repetitions>	1292
:TRIGger[:SEquence]:LXI:ALARm[:SET]:REPeat? "alarmEvent"	1292
:TRIGger[:SEquence]:LXI:ALARm[:SET]:TIME:SEConds "alarmEvent",<seconds>	1290
:TRIGger[:SEquence]:LXI:ALARm[:SET]:TIME:SEConds? "alarmEvent"	1290
:TRIGger[:SEquence]:LXI:ALARm[:SET]:TIME[:VALue] "alarmEvent",<seconds>, <fractionalSeconds>	1289
:TRIGger[:SEquence]:LXI:ALARm[:SET]:TIME[:VALue]:ABSolute "alarmEvent","date","time"	1286
:TRIGger[:SEquence]:LXI:ALARm[:SET]:TIME[:VALue]:ABSolute? "alarmEvent"	1287
:TRIGger[:SEquence]:LXI:ALARm[:SET]:TIME[:VALue]:FRACTION "alarmEvent",<fractionalSeconds>	1290
:TRIGger[:SEquence]:LXI:ALARm[:SET]:TIME[:VALue]:FRACTION? "alarmEvent"	1291
:TRIGger[:SEquence]:LXI:ALARm[:SET]:TIME[:VALue]:RELative "alarmEvent",<seconds>	1291
:TRIGger[:SEquence]:LXI:ALARm[:SET]:TIME[:VALue]:RELative? "alarmEvent"	1291
:TRIGger[:SEquence]:LXI:ALARm[:SET]:TIME[:VALue]?	1289
:TRIGger[:SEquence]:LXI:LAN:ADD "LANEVENT"	1282
:TRIGger[:SEquence]:LXI:LAN:COUNT?	1284
:TRIGger[:SEquence]:LXI:LAN:DISable:ALL	1279

List of Commands

:TRIGger[:SEQuence]:LXI:LAN:LIST?	1279
:TRIGger[:SEQuence]:LXI:LAN:REMOve:ALL	1283
:TRIGger[:SEQuence]:LXI:LAN:REMOve[:EVENT] "LANEVENT"	1283
:TRIGger[:SEQuence]:LXI:LAN[:SET]:CONFIgure "lanEvent", <enable>, <detection>, <delay>, <filter>, <identi- fier>	1285
:TRIGger[:SEQuence]:LXI:LAN[:SET]:DELAy "LANEVENT", <time>	1281
:TRIGger[:SEQuence]:LXI:LAN[:SET]:DELAy? "lanEvent"	1281
:TRIGger[:SEQuence]:LXI:LAN[:SET]:DETEction "LANEVENT", HIGH LOW RISE FALL	1280
:TRIGger[:SEQuence]:LXI:LAN[:SET]:DETEction? "LANEVENT"	1280
:TRIGger[:SEQuence]:LXI:LAN[:SET]:ENABled "LANEVENT", ON OFF 1 0	1281
:TRIGger[:SEQuence]:LXI:LAN[:SET]:ENABled? "LANEVENT"	1282
:TRIGger[:SEQuence]:LXI:LAN[:SET]:FILTer "LANEVENT", "filterString"	1284
:TRIGger[:SEQuence]:LXI:LAN[:SET]:FILTer?	1284
:TRIGger[:SEQuence]:LXI:LAN[:SET]:IDENtifier "LANEVENT", "identifier"	1284
:TRIGger[:SEQuence]:LXI:LAN[:SET]:IDENtifier? "LANEVENT"	1284
:TRIGger[:SEQuence]:OFFSet <time>	1306
:TRIGger[:SEQuence]:OFFSet:STATe OFF ON 0 1	1306
:TRIGger[:SEQuence]:OFFSet:STATe?	1306
:TRIGger[:SEQuence]:OFFSet?	1306
:TRIGger[:SEQuence]:QDEMod:DELAy <time>	1298
:TRIGger[:SEQuence]:QDEMod:DELAy:STATe OFF ON 0 1	1298
:TRIGger[:SEQuence]:QDEMod:DELAy:STATe?	1298
:TRIGger[:SEQuence]:QDEMod:DELAy?	1298
:TRIGger[:SEQuence]:QDEMod:LEVel <voltage>	1297
:TRIGger[:SEQuence]:QDEMod:LEVel?	1297
:TRIGger[:SEQuence]:QDEMod:SLOPe POSitive NEGative	1298
:TRIGger[:SEQuence]:QDEMod:SLOPe?	1298
:TRIGger[:SEQuence]:QINPut:DELAy <time>	1301
:TRIGger[:SEQuence]:QINPut:DELAy:STATe OFF ON 0 1	1301
:TRIGger[:SEQuence]:QINPut:DELAy:STATe?	1301
:TRIGger[:SEQuence]:QINPut:DELAy?	1301

List of Commands

:TRIGger[:SEquence]:QINPut:LEVel <voltage>	1300
:TRIGger[:SEquence]:QINPut:LEVel?	1300
:TRIGger[:SEquence]:QINPut:SLOPe POSitive NEGative	1300
:TRIGger[:SEquence]:QINPut:SLOPe?	1300
:TRIGger[:SEquence]:RFBurst:DELAy <time>	1271
:TRIGger[:SEquence]:RFBurst:DELAy:STATe OFF ON 0 1	1271
:TRIGger[:SEquence]:RFBurst:DELAy:STATe?	1271
:TRIGger[:SEquence]:RFBurst:DELAy?	1271
:TRIGger[:SEquence]:RFBurst:LEVel:ABSolute <ampl>	1270
:TRIGger[:SEquence]:RFBurst:LEVel:ABSolute?	1270
:TRIGger[:SEquence]:RFBurst:LEVel:RELative <ampl>	1270
:TRIGger[:SEquence]:RFBurst:LEVel:RELative?	1270
:TRIGger[:SEquence]:RFBurst:LEVel:TYPE ABSolute RELative	1270
:TRIGger[:SEquence]:RFBurst:LEVel:TYPE?	1270
:TRIGger[:SEquence]:RFBurst:SLOPe POSitive NEGative	1270
:TRIGger[:SEquence]:RFBurst:SLOPe?	1270
:TRIGger[:SEquence]:VIDeo:DELAy <time>.	1263
:TRIGger[:SEquence]:VIDeo:DELAy:STATe OFF ON 0 1	1263
:TRIGger[:SEquence]:VIDeo:DELAy:STATe?	1263
:TRIGger[:SEquence]:VIDeo:DELAy?	1263
:TRIGger[:SEquence]:VIDeo:LEVel <ampl>.	1262
:TRIGger[:SEquence]:VIDeo:LEVel?	1262
:TRIGger[:SEquence]:VIDeo:SLOPe POSitive NEGative	1262
:TRIGger[:SEquence]:VIDeo:SLOPe?	1262
:TRIGger TRIGger1 TRIGger2[:SEquence]:OUTPut HSWP MEASuring MAIN GATE GTRigger OEVen. . .	1106
:TRIGger TRIGger1 TRIGger2[:SEquence]:OUTPut:POLarity POSitive NEGative	1106
:TRIGger TRIGger1 TRIGger2[:SEquence]:OUTPut:POLarity?	1106
:TRIGger TRIGger1 TRIGger2[:SEquence]:OUTPut?	1106
:TRIGger1 TRIGger[:SEquence]:LXI:ALARm:COUNt?	1294
:UNIT:ACPower:POWER:PSD DBMHZ DBMMHZ	404
:UNIT:ACPower:POWER:PSD?	404

List of Commands

[:SENSe]:ACPower:AVERage:COUNt <integer>	377
[:SENSe]:ACPower:AVERage:COUNt?	377
[:SENSe]:ACPower:AVERage:TCONtrol EXPonential REPeat.	378
[:SENSe]:ACPower:AVERage:TCONtrol?	378
[:SENSe]:ACPower:AVERage[:STATe] OFF ON 0 1	377
[:SENSe]:ACPower:AVERage[:STATe]?	377
[:SENSe]:ACPower:BANDwidth:SHAPE GAUSSian FLATtop.	363
[:SENSe]:ACPower:BANDwidth:SHAPE?	363
[:SENSe]:ACPower:BANDwidth:TYPE DB3 DB6	364
[:SENSe]:ACPower:BANDwidth:TYPE?	364
[:SENSe]:ACPower:BANDwidth:VIDeo <freq>	362
[:SENSe]:ACPower:BANDwidth:VIDeo:AUTO OFF ON 0 1	362
[:SENSe]:ACPower:BANDwidth:VIDeo:AUTO?	362
[:SENSe]:ACPower:BANDwidth:VIDeo?	362
[:SENSe]:ACPower:BANDwidth[:RESolution] <bandwidth>.	361
[:SENSe]:ACPower:BANDwidth[:RESolution]:AUTO ON OFF 1 0.	361
[:SENSe]:ACPower:BANDwidth[:RESolution]:AUTO?	361
[:SENSe]:ACPower:BANDwidth[:RESolution]?	361
[:SENSe]:ACPower:CARRier[1] 2:AUTO[:STATe] OFF ON 0 1.	381
[:SENSe]:ACPower:CARRier[1] 2:AUTO[:STATe]?	381
[:SENSe]:ACPower:CARRier[1] 2:COUNt <integer>	378
[:SENSe]:ACPower:CARRier[1] 2:COUNt?	378
[:SENSe]:ACPower:CARRier[1] 2:CPSD <real>	382
[:SENSe]:ACPower:CARRier[1] 2:CPSD?	382
[:SENSe]:ACPower:CARRier[1] 2:LIST:BANDwidth[:INTegration] <freq>,	386
[:SENSe]:ACPower:CARRier[1] 2:LIST:BANDwidth[:INTegration]?	386
[:SENSe]:ACPower:CARRier[1] 2:LIST:COUPlE OFF ON 0 1,	383
[:SENSe]:ACPower:CARRier[1] 2:LIST:COUPlE?	383
[:SENSe]:ACPower:CARRier[1] 2:LIST:FILTer:ALPHa <real>,	387
[:SENSe]:ACPower:CARRier[1] 2:LIST:FILTer:ALPHa?	387
[:SENSe]:ACPower:CARRier[1] 2:LIST:METHod IBW RRC,	387

List of Commands

[[:SENSe]:ACPower:CARRier[1] 2:LIST:METhod?	387
[[:SENSe]:ACPower:CARRier[1] 2:LIST:PPResent YES NO,	384
[[:SENSe]:ACPower:CARRier[1] 2:LIST:PPResent?	384
[[:SENSe]:ACPower:CARRier[1] 2:LIST:WIDTh <bandwidth>,	385
[[:SENSe]:ACPower:CARRier[1] 2:LIST:WIDTh?	385
[[:SENSe]:ACPower:CARRier[1] 2:RCARrier <integer>	379
[[:SENSe]:ACPower:CARRier[1] 2:RCARrier:AUTO OFF ON 0 1	379
[[:SENSe]:ACPower:CARRier[1] 2:RCARrier:AUTO?	379
[[:SENSe]:ACPower:CARRier[1] 2:RCARrier?	379
[[:SENSe]:ACPower:CARRier[1] 2:RCFRrequency <freq>	380
[[:SENSe]:ACPower:CARRier[1] 2:RCFRrequency:AUTO OFF ON 0 1	380
[[:SENSe]:ACPower:CARRier[1] 2:RCFRrequency:AUTO?	380
[[:SENSe]:ACPower:CARRier[1] 2:RCFRrequency?	380
[[:SENSe]:ACPower:CARRier[1] 2[:POWer] <real>	381
[[:SENSe]:ACPower:CARRier[1] 2[:POWer]?	381
[[:SENSe]:ACPower:CORRection:NOISe[:AUTO] OFF ON 0 1	407
[[:SENSe]:ACPower:CORRection:NOISe[:AUTO]?	407
[[:SENSe]:ACPower:DETEctor:AUTO ON OFF 1 0	426
[[:SENSe]:ACPower:DETEctor:AUTO?	426
[[:SENSe]:ACPower:DETEctor[:FUNction] AVERAge NEGAtive NORMAl POSitive SAMPle	425
[[:SENSe]:ACPower:DETEctor[:FUNction]?	425
[[:SENSe]:ACPower:FILTer[:RRC]:ALPHa <real>	406
[[:SENSe]:ACPower:FILTer[:RRC]:ALPHa?	406
[[:SENSe]:ACPower:FILTer[:RRC][:STATe] OFF ON 0 1	405
[[:SENSe]:ACPower:FILTer[:RRC][:STATe]?	405
[[:SENSe]:ACPower:FREQuency:SPAN <freq>	418
[[:SENSe]:ACPower:FREQuency:SPAN:FULL	419
[[:SENSe]:ACPower:FREQuency:SPAN:PREVious	419
[[:SENSe]:ACPower:FREQuency:SPAN?	418
[[:SENSe]:ACPower:FREQuency:SYNThesis:AUTO[:STATe] OFF ON 0 1	401
[[:SENSe]:ACPower:FREQuency:SYNThesis:AUTO[:STATe]?	401

List of Commands

[[:SENSe]:ACPower:FREQuency:SYNThesis[:STATe] 1 2 3	401
[[:SENSe]:ACPower:FREQuency:SYNThesis[:STATe]?	401
[[:SENSe]:ACPower:METHod IBW IBWRange FAST RBW	402
[[:SENSe]:ACPower:METHod?	402
[[:SENSe]:ACPower:OFFSet[1] 2:LIST:ABSolute <real>, <real>, <real>, <real>, <real>, <real>	396
[[:SENSe]:ACPower:OFFSet[1] 2:LIST:ABSolute?	396
[[:SENSe]:ACPower:OFFSet[1] 2:LIST:BANDwidth:RESolution <bandwidth>, <bandwidth>, <bandwidth>, <bandwidth>, <bandwidth>, <bandwidth>	392
[[:SENSe]:ACPower:OFFSet[1] 2:LIST:BANDwidth:RESolution:AUTO ON OFF 1 0, ON OFF 1 0, ON OFF 1 0, ON OFF 1 0, ON OFF 1 0, ON OFF 1 0	392
[[:SENSe]:ACPower:OFFSet[1] 2:LIST:BANDwidth:RESolution:AUTO?	392
[[:SENSe]:ACPower:OFFSet[1] 2:LIST:BANDwidth:RESolution?	392
[[:SENSe]:ACPower:OFFSet[1] 2:LIST:BANDwidth:SHAPE GAUSSian FLATtop, GAUSSian FLATtop, GAUSSian FLATtop, GAUSSian FLATtop, GAUSSian FLATtop, GAUSSian FLATtop	394
[[:SENSe]:ACPower:OFFSet[1] 2:LIST:BANDwidth:SHAPE?	394
[[:SENSe]:ACPower:OFFSet[1] 2:LIST:BANDwidth:TYPE DB3 DB6, DB3 DB6, DB3 DB6, DB3 DB6, DB3 DB6, DB3 DB6	395
[[:SENSe]:ACPower:OFFSet[1] 2:LIST:BANDwidth:TYPE?	395
[[:SENSe]:ACPower:OFFSet[1] 2:LIST:BANDwidth:VIDeo <freq>, <freq>, <freq>, <freq>, <freq>, <freq> ..	393
[[:SENSe]:ACPower:OFFSet[1] 2:LIST:BANDwidth:VIDeo:AUTO OFF ON 0 1, OFF ON 0 1, OFF ON 0 1, OFF ON 0 1, OFF ON 0 1, OFF ON 0 1	393
[[:SENSe]:ACPower:OFFSet[1] 2:LIST:BANDwidth:VIDeo:AUTO?	393
[[:SENSe]:ACPower:OFFSet[1] 2:LIST:BANDwidth:VIDeo?	393
[[:SENSe]:ACPower:OFFSet[1] 2:LIST:BANDwidth[:INTegration] <bandwidth>, <bandwidth>, <bandwidth>, <bandwidth>, <bandwidth>, <bandwidth>	391
[[:SENSe]:ACPower:OFFSet[1] 2:LIST:BANDwidth[:INTegration]?	391
[[:SENSe]:ACPower:OFFSet[1] 2:LIST:RCARrier <real>, <real>, <real>, <real>, <real>, <real>	398
[[:SENSe]:ACPower:OFFSet[1] 2:LIST:RCARrier?	398
[[:SENSe]:ACPower:OFFSet[1] 2:LIST:RPSDensity <rel_ampl>, <rel_ampl>, <rel_ampl>, <rel_ampl>, <rel_ampl>, <rel_ampl>	399
[[:SENSe]:ACPower:OFFSet[1] 2:LIST:RPSDensity?	399
[[:SENSe]:ACPower:OFFSet[1] 2:LIST:STATe OFF ON 0 1, OFF ON 0 1, OFF ON 0 1, OFF ON 0 1, OFF ON 0 1, OFF ON 0 1	389
[[:SENSe]:ACPower:OFFSet[1] 2:LIST:STATe?	389

List of Commands

[[:SENSe]:CORRection:CSET[1]2 3 4:COMMeNt?	1097
[[:SENSe]:CORRection:CSET[1]2 3 4:DATA <freq>, <ampl>,	1100
[[:SENSe]:CORRection:CSET[1]2 3 4:DATA:MERGe <freq>, <ampl>,...	1101
[[:SENSe]:CORRection:CSET[1]2 3 4:DATA?	1100
[[:SENSe]:CORRection:CSET[1]2 3 4:DELeTe	1099
[[:SENSe]:CORRection:CSET[1]2 3 4:DESCription "text"	1096
[[:SENSe]:CORRection:CSET[1]2 3 4:DESCription?	1096
[[:SENSe]:CORRection:CSET[1]2 3 4:X:SPACing LINear LOGarithmic	1096
[[:SENSe]:CORRection:CSET[1]2 3 4:X:SPACing?	1096
[[:SENSe]:CORRection:CSET[1]2 3 4[::STATe] ON OFF 1 0	1093
[[:SENSe]:CORRection:CSET[1]2 3 4[::STATe]?	1093
[[:SENSe]:CORRection:IMPedance[::INPut][::MAGNitude] 50 75	1066
[[:SENSe]:CORRection:IMPedance[::INPut][::MAGNitude]?	1066
[[:SENSe]:CORRection:IQ:I:GAIN <rel_ampl>	1086
[[:SENSe]:CORRection:IQ:I:GAIN?	1086
[[:SENSe]:CORRection:IQ:I Q:ATTenuation <rel_ampl>	1078
[[:SENSe]:CORRection:IQ:I Q:ATTenuation:RATio <real>	1078
[[:SENSe]:CORRection:IQ:I Q:ATTenuation:RATio?	1078
[[:SENSe]:CORRection:IQ:I Q:ATTenuation?	1078
[[:SENSe]:CORRection:IQ:Q:GAIN <rel_ampl>	1087
[[:SENSe]:CORRection:IQ:Q:GAIN?	1087
[[:SENSe]:CORRection:IQ:Q:SKEW <seconds>	1077
[[:SENSe]:CORRection:IQ:Q:SKEW?	1077
[[:SENSe]:CORRection:IQ[::I]:SKEW <seconds>	1073
[[:SENSe]:CORRection:IQ[::I]:SKEW?	1073
[[:SENSe]:CORRection:MS[::RF]:GAIN <rel_ampl>	1085
[[:SENSe]:CORRection:MS[::RF]:GAIN?	1085
[[:SENSe]:CORRection:SA[::RF]:GAIN <rel_ampl>	1084
[[:SENSe]:CORRection:SA[::RF]:GAIN?	1084
[[:SENSe]:EVM:ANALySis:SUBFrame <integer>	878
[[:SENSe]:EVM:ANALySis:SUBFrame?	878

List of Commands

[[:SENSe]:EVM:AVERage:COUNT <integer>	876
[[:SENSe]:EVM:AVERage:COUNT?	876
[[:SENSe]:EVM:AVERage:TCONtrol EXPonential REPeat	877
[[:SENSe]:EVM:AVERage:TCONtrol?	877
[[:SENSe]:EVM:AVERage[:STATe] OFF ON 0 1	876
[[:SENSe]:EVM:AVERage[:STATe]?	876
[[:SENSe]:EVM:RINterval <integer>	877
[[:SENSe]:EVM:RINterval?	877
[[:SENSe]:FEED RF AIQ IQ IONLy QONLy AREFERENCE	1065
[[:SENSe]:FEED:AREFERENCE REF50 REF4800 COMB OFF	1082
[[:SENSe]:FEED:AREFERENCE?	1082
[[:SENSe]:FEED:DATA INPut STORed RECOreded	1088
[[:SENSe]:FEED:DATA:STORe	1089
[[:SENSe]:FEED:DATA?	1088
[[:SENSe]:FEED:IQ:TYPE IQ IONLy QONLy	1070
[[:SENSe]:FEED:IQ:TYPE?	1070
[[:SENSe]:FEED?	1065
[[:SENSe]:FREQuency:CENTer <freq>	1061
[[:SENSe]:FREQuency:CENTer:STEP:AUTO ON OFF 1 0	1063
[[:SENSe]:FREQuency:CENTer:STEP:AUTO?	1063
[[:SENSe]:FREQuency:CENTer:STEP[:INCRement] <freq>	1063
[[:SENSe]:FREQuency:CENTer:STEP[:INCRement]?	1063
[[:SENSe]:FREQuency:CENTer?	1061
[[:SENSe]:FREQuency:IQ:CENTer <freq>	1062
[[:SENSe]:FREQuency:IQ:CENTer?	1062
[[:SENSe]:FREQuency:RF:CENTer <freq>	1062
[[:SENSe]:FREQuency:RF:CENTer?	1062
[[:SENSe]:MONitor:AVERage:COUNT <integer>	1014
[[:SENSe]:MONitor:AVERage:COUNT?	1014
[[:SENSe]:MONitor:AVERage:TCONtrol EXPonential REPeat	1015
[[:SENSe]:MONitor:AVERage:TCONtrol?	1015

List of Commands

[:SENSe]:MONitor:AVERage[:STATe] OFF ON 0 1	1014
[:SENSe]:MONitor:AVERage[:STATe]?	1014
[:SENSe]:MONitor:BANDwidth:VIDeo <bandwidth>	998
[:SENSe]:MONitor:BANDwidth:VIDeo:AUTO ON OFF 1 0	998
[:SENSe]:MONitor:BANDwidth:VIDeo:AUTO?	998
[:SENSe]:MONitor:BANDwidth:VIDeo:RATio <real> [:SENSe]:MONitor:BANDwidth:VIDeo:RATio?	999
[:SENSe]:MONitor:BANDwidth:VIDeo:RATio:AUTO OFF ON 0 1	999
[:SENSe]:MONitor:BANDwidth:VIDeo:RATio:AUTO?	999
[:SENSe]:MONitor:BANDwidth:VIDeo?	998
[:SENSe]:MONitor:BANDwidth[:RESolution] <freq>	997
[:SENSe]:MONitor:BANDwidth[:RESolution]:AUTO OFF ON 0 1	997
[:SENSe]:MONitor:BANDwidth[:RESolution]:AUTO?	997
[:SENSe]:MONitor:BANDwidth[:RESolution]?	997
[:SENSe]:MONitor:DETEctor:AUTO ON OFF 1 0	1031
[:SENSe]:MONitor:DETEctor:AUTO?	1031
[:SENSe]:MONitor:DETEctor:TRACe AVERage NEGative NORMal POSitive SAMPLE	1030
[:SENSe]:MONitor:DETEctor:TRACe?	1030
[:SENSe]:MONitor:FREQuency:SPAN <freq>	1024
[:SENSe]:MONitor:FREQuency:SPAN:BANDwidth[:RESolution]:RATio <integer>	999
[:SENSe]:MONitor:FREQuency:SPAN:BANDwidth[:RESolution]:RATio:AUTO OFF ON 0 1	999
[:SENSe]:MONitor:FREQuency:SPAN:BANDwidth[:RESolution]:RATio:AUTO?	999
[:SENSe]:MONitor:FREQuency:SPAN:BANDwidth[:RESolution]:RATio?	999
[:SENSe]:MONitor:FREQuency:SPAN:FULL	1025
[:SENSe]:MONitor:FREQuency:SPAN:PREVIOUS	1025
[:SENSe]:MONitor:FREQuency:SPAN?	1024
[:SENSe]:MONitor:SWEep:POINts <integer>	1027
[:SENSe]:MONitor:SWEep:POINts?	1027
[:SENSe]:MONitor:SWEep:TIME <time>	1026
[:SENSe]:MONitor:SWEep:TIME:AUTO OFF ON 0 1	1026
[:SENSe]:MONitor:SWEep:TIME:AUTO?	1026

List of Commands

[[:SENSe]:MONitor:SWEEp:TIME?	1026
[[:SENSe]:OBWidth:AVERAge:COUNT <integer>	679
[[:SENSe]:OBWidth:AVERAge:COUNT?	679
[[:SENSe]:OBWidth:AVERAge:TCONtrol EXPonential REPeat	680
[[:SENSe]:OBWidth:AVERAge:TCONtrol?	680
[[:SENSe]:OBWidth:AVERAge[:STATe] ON OFF 1 0	679
[[:SENSe]:OBWidth:AVERAge[:STATe]?	679
[[:SENSe]:OBWidth:BANDwidth:SHAPE GAUSSian FLATtop	667
[[:SENSe]:OBWidth:BANDwidth:SHAPE?	667
[[:SENSe]:OBWidth:BANDwidth:VIDeo <bandwidth>	666
[[:SENSe]:OBWidth:BANDwidth:VIDeo:AUTO ON OFF 1 0	666
[[:SENSe]:OBWidth:BANDwidth:VIDeo:AUTO?	666
[[:SENSe]:OBWidth:BANDwidth:VIDeo?	666
[[:SENSe]:OBWidth:BANDwidth[:RESolution] <bandwidth>	665
[[:SENSe]:OBWidth:BANDwidth[:RESolution]:AUTO ON OFF 1 0	665
[[:SENSe]:OBWidth:BANDwidth[:RESolution]:AUTO?	665
[[:SENSe]:OBWidth:BANDwidth[:RESolution]?	665
[[:SENSe]:OBWidth:DETEctor:AUTO ON OFF 1 0	701
[[:SENSe]:OBWidth:DETEctor:AUTO?	701
[[:SENSe]:OBWidth:DETEctor[:FUNctIon] NORMal AVERAge POSitive SAMPle NEGative	700
[[:SENSe]:OBWidth:DETEctor[:FUNctIon]?	700
[[:SENSe]:OBWidth:FREQUency:SPAN <freq>	693
[[:SENSe]:OBWidth:FREQUency:SPAN:FULL	694
[[:SENSe]:OBWidth:FREQUency:SPAN:PREVious	694
[[:SENSe]:OBWidth:FREQUency:SPAN?	693
[[:SENSe]:OBWidth:IF:GAIN:AUTO[:STATe] ON OFF 1 0	682
[[:SENSe]:OBWidth:IF:GAIN:AUTO[:STATe]?	682
[[:SENSe]:OBWidth:IF:GAIN[:STATe] ON OFF 1 0	683
[[:SENSe]:OBWidth:IF:GAIN[:STATe]?	683
[[:SENSe]:OBWidth:MAXHold ON OFF 1 0	680
[[:SENSe]:OBWidth:MAXHold?	680

List of Commands

[:SENSe]:OBWidth:PERCent <real>	681
[:SENSe]:OBWidth:PERCent?	681
[:SENSe]:OBWidth:SWEep:POINts <integer>	697
[:SENSe]:OBWidth:SWEep:POINts?	697
[:SENSe]:OBWidth:SWEep:TIME <time>	695
[:SENSe]:OBWidth:SWEep:TIME:AUTO OFF ON 0 1	695
[:SENSe]:OBWidth:SWEep:TIME:AUTO:RULes NORMAl ACCuracy	696
[:SENSe]:OBWidth:SWEep:TIME:AUTO:RULes?	696
[:SENSe]:OBWidth:SWEep:TIME:AUTO?	695
[:SENSe]:OBWidth:SWEep:TIME?	695
[:SENSe]:OBWidth:XDB <rel_ampl>	681
[:SENSe]:OBWidth:XDB?	681
[:SENSe]:POWer:IQ:Q:RANGe[:UPPer] <ampl>	1048
[:SENSe]:POWer:IQ:Q:RANGe[:UPPer]?	1048
[:SENSe]:POWer:IQ:RANGe:AUTO OFF ON 0 1	1045
[:SENSe]:POWer:IQ:RANGe:AUTO?	1045
[:SENSe]:POWer:IQ[:I]:RANGe[:UPPer] <ampl>	1046
[:SENSe]:POWer:IQ[:I]:RANGe[:UPPer]?	1046
[:SENSe]:POWer[:RF]:ATTenuation <rel_ampl>	1037
[:SENSe]:POWer[:RF]:ATTenuation:AUTO OFF ON 0 1	1037
[:SENSe]:POWer[:RF]:ATTenuation:AUTO?	1037
[:SENSe]:POWer[:RF]:ATTenuation:STEP[:INCRement] 10 dB 2 dB	1042
[:SENSe]:POWer[:RF]:ATTenuation:STEP[:INCRement]?	1042
[:SENSe]:POWer[:RF]:ATTenuation?	1037
[:SENSe]:POWer[:RF]:EATTenuation <rel_ampl>	1040
[:SENSe]:POWer[:RF]:EATTenuation:STATe OFF ON 0 1	1039
[:SENSe]:POWer[:RF]:EATTenuation:STATe?	1039
[:SENSe]:POWer[:RF]:EATTenuation?	1040
[:SENSe]:POWer[:RF]:GAIN:BAND LOW FULL	1052
[:SENSe]:POWer[:RF]:GAIN:BAND?	1052
[:SENSe]:POWer[:RF]:GAIN[:STATe] OFF ON 0 1	1052

List of Commands

[:SENSe]:POWer[:RF]:GAIN[:STATe]?	1052
[:SENSe]:POWer[:RF]:MIXer:RANGe[:UPPer] <real>	1043
[:SENSe]:POWer[:RF]:MIXer:RANGe[:UPPer]?	1043
[:SENSe]:POWer[:RF]:PADJust <freq>	1050
[:SENSe]:POWer[:RF]:PADJust:PRESelector MWAVE MMWave EXTeRnal	1051
[:SENSe]:POWer[:RF]:PADJust:PRESelector?	1051
[:SENSe]:POWer[:RF]:PADJust?	1050
[:SENSe]:POWer[:RF]:PCENter	1049
[:SENSe]:POWer[:RF]:RANGe:AUTO ON OFF 1 0	1042
[:SENSe]:POWer[:RF]:RANGe:AUTO?	1042
[:SENSe]:POWer[:RF]:RANGe:OPTimize IMMEDIATE	1040
[:SENSe]:POWer[:RF]:RANGe:OPTimize:ATTenuation OFF ELECTrical COMBined	1041
[:SENSe]:POWer[:RF]:RANGe:OPTimize:ATTenuation?	1041
[:SENSe]:PSTatistic:SLTView[:STATe]?	747
[:SENSe]:PSTatistic:BANDwidth <freq>	713
[:SENSe]:PSTatistic:BANDwidth?	713
[:SENSe]:PSTatistic:COUNts <integer>	725
[:SENSe]:PSTatistic:COUNts?	725
[:SENSe]:PSTatistic:GAUSSian[:STATe] OFF ON 0 1	742
[:SENSe]:PSTatistic:GAUSSian[:STATe]?	742
[:SENSe]:PSTatistic:IF:GAIN:AUTO[:STATe] ON OFF 1 0	728
[:SENSe]:PSTatistic:IF:GAIN:AUTO[:STATe]?	728
[:SENSe]:PSTatistic:IF:GAIN[:STATe] ON OFF 1 0	729
[:SENSe]:PSTatistic:IF:GAIN[:STATe]?	729
[:SENSe]:PSTatistic:RTRace[:STATe] OFF ON 0 1	741
[:SENSe]:PSTatistic:RTRace[:STATe]?	741
[:SENSe]:PSTatistic:SLTView[:STATe] OFF ON 0 1	747
[:SENSe]:PSTatistic:SWEep:CYCLes <integer>	726
[:SENSe]:PSTatistic:SWEep:CYCLes?	726
[:SENSe]:PSTatistic:SWEep:OFFSet <time>	727
[:SENSe]:PSTatistic:SWEep:OFFSet?	727

List of Commands

[[:SENSe]:PSTatistic:SWEep:TIME <time>	726
[[:SENSe]:PSTatistic:SWEep:TIME <time>	727
[[:SENSe]:PSTatistic:SWEep:TIME?	726
[[:SENSe]:PSTatistic:SWEep:TIME?	727
[[:SENSe]:PVTime:AVERAge:COUNt <integer>.	460
[[:SENSe]:PVTime:AVERAge:COUNt?	460
[[:SENSe]:PVTime:AVERAge:TCONtrol EXPonential REPeat.	461
[[:SENSe]:PVTime:AVERAge:TCONtrol?	461
[[:SENSe]:PVTime:AVERAge:TYPE LOG LPOWer RMS POWer	461
[[:SENSe]:PVTime:AVERAge:TYPE?	461
[[:SENSe]:PVTime:AVERAge[::STATe] OFF ON 0 1	460
[[:SENSe]:PVTime:AVERAge[::STATe]?	460
[[:SENSe]:PVTime:IF:GAIN:AUTO[::STATe] ON OFF 1 0.	463
[[:SENSe]:PVTime:IF:GAIN:AUTO[::STATe]?	463
[[:SENSe]:PVTime:IF:GAIN[::STATe] ON OFF 1 0.	464
[[:SENSe]:PVTime:IF:GAIN[::STATe]?	464
[[:SENSe]:PVTime:MASK:LIST:LOWer:ABSolute <ampl>, <ampl>, <ampl>, <ampl>.	465
[[:SENSe]:PVTime:MASK:LIST:LOWer:ABSolute?	465
[[:SENSe]:PVTime:MASK:LIST:LOWer:POINts?	466
[[:SENSe]:PVTime:MASK:LIST:LOWer:RELative <ampl>, <ampl>, <ampl>, <ampl>	467
[[:SENSe]:PVTime:MASK:LIST:LOWer:RELative?.	467
[[:SENSe]:PVTime:MASK:LIST:LOWer:TIME <time>, <time>, <time>, <time>	467
[[:SENSe]:PVTime:MASK:LIST:LOWer:TIME?	467
[[:SENSe]:PVTime:MASK:LIST:UPPer:ABSolute <ampl>, <ampl>, <ampl>, <ampl>	468
[[:SENSe]:PVTime:MASK:LIST:UPPer:ABSolute?	468
[[:SENSe]:PVTime:MASK:LIST:UPPer:POINts?	469
[[:SENSe]:PVTime:MASK:LIST:UPPer:RELative <rel_ampl>, <rel_ampl>, <rel_ampl>, <rel_ampl>	470
[[:SENSe]:PVTime:MASK:LIST:UPPer:RELative?	470
[[:SENSe]:PVTime:MASK:LIST:UPPer:TIME <time>, <time>, <time>, <time>	470
[[:SENSe]:PVTime:MASK:LIST:UPPer:TIME?	470
[[:SENSe]:PVTime:MASK:SELect CUSTom STANdard	464

List of Commands

[[:SENSe]:PVTime:MASK:SElect?	464
[[:SENSe]:PVTime:SWEEP:TIME <integer>	462
[[:SENSe]:PVTime:SWEEP:TIME?	462
[[:SENSe]:RADio:CONFigure:HSDPa[:STATe] 0 1 OFF ON	1161
[[:SENSe]:RADio:CONFigure:HSDPa[:STATe]?	1161
[[:SENSe]:RADio:STANdard:DEVice BTS MS	1159
[[:SENSe]:RADio:STANdard:DEVice?	1159
[[:SENSe]:RECORDing:ABORT	1090
[[:SENSe]:RECORDing:INITiate[:IMMediate]	1090
[[:SENSe]:RECORDing:LENGth <real>,SECOnds RECOrds POINts	1091
[[:SENSe]:RECORDing:LENGth:STATe MAX MANual	1091
[[:SENSe]:RECORDing:LENGth:STATe?	1091
[[:SENSe]:RECORDing:LENGth:UNIT?	1091
[[:SENSe]:RECORDing:LENGth:VALue?	1091
[[:SENSe]:ROSCillator:COUPLing NORMal NACQuisition	1105
[[:SENSe]:ROSCillator:COUPLing?	1105
[[:SENSe]:ROSCillator:EXTernal:FREQUency <freq>	1103
[[:SENSe]:ROSCillator:EXTernal:FREQUency?	1103
[[:SENSe]:ROSCillator:SOURce INTernal EXTernal	1102
[[:SENSe]:ROSCillator:SOURce:TYPE INTernal EXTernal SENSe	1101
[[:SENSe]:ROSCillator:SOURce:TYPE?	1101
[[:SENSe]:ROSCillator:SOURce?	1102
[[:SENSe]:SEMAsk:AVERAge:COUNt <integer>	520
[[:SENSe]:SEMAsk:AVERAge:COUNt?	520
[[:SENSe]:SEMAsk:AVERAge[:STATe] ON OFF 1 0	520
[[:SENSe]:SEMAsk:AVERAge[:STATe]?	520
[[:SENSe]:SEMAsk:BANDwidth[1] 2:INTegration <bandwidth>	521
[[:SENSe]:SEMAsk:BANDwidth[1] 2:INTegration?	521
[[:SENSe]:SEMAsk:BANDwidth[1] 2:VIDeo <bandwidth>	525
[[:SENSe]:SEMAsk:BANDwidth[1] 2:VIDeo:AUTO OFF ON 1 0	525
[[:SENSe]:SEMAsk:BANDwidth[1] 2:VIDeo:AUTO?	525

List of Commands

[[:SENSe]:SEMAsk:BANDwidth[1] 2:VIDeo:RATio <real>	526
[[:SENSe]:SEMAsk:BANDwidth[1] 2:VIDeo:RATio:AUTO OFF ON 1 0	526
[[:SENSe]:SEMAsk:BANDwidth[1] 2:VIDeo:RATio:AUTO?	526
[[:SENSe]:SEMAsk:BANDwidth[1] 2:VIDeo:RATio	526
[[:SENSe]:SEMAsk:BANDwidth[1] 2:VIDeo?	525
[[:SENSe]:SEMAsk:BANDwidth[1] 2[:RESolution] <bandwidth>	524
[[:SENSe]:SEMAsk:BANDwidth[1] 2[:RESolution]:AUTO OFF ON 1 0	524
[[:SENSe]:SEMAsk:BANDwidth[1] 2[:RESolution]:AUTO?	524
[[:SENSe]:SEMAsk:BANDwidth[1] 2[:RESolution]?	524
[[:SENSe]:SEMAsk:CARRier:AUTO[:STATe] OFF ON 1 0	527
[[:SENSe]:SEMAsk:CARRier:AUTO[:STATe]?	527
[[:SENSe]:SEMAsk:CARRier:CPSD <real>	528
[[:SENSe]:SEMAsk:CARRier:CPSD?	528
[[:SENSe]:SEMAsk:CARRier:PEAK[:POWer] <real>	529
[[:SENSe]:SEMAsk:CARRier:PEAK[:POWer]?	529
[[:SENSe]:SEMAsk:CARRier[:POWer] <real>	527
[[:SENSe]:SEMAsk:CARRier[:POWer]?	527
[[:SENSe]:SEMAsk:DETEctor:CARRier:AUTO ON OFF 1 0	564
[[:SENSe]:SEMAsk:DETEctor:CARRier:AUTO?	564
[[:SENSe]:SEMAsk:DETEctor:CARRier[:FUNctioN] AVERAge NEGAtive NORMAl POSitive SAMPle	563
[[:SENSe]:SEMAsk:DETEctor:CARRier[:FUNctioN]?	563
[[:SENSe]:SEMAsk:DETEctor:OFFSet:AUTO ON OFF 1 0	565
[[:SENSe]:SEMAsk:DETEctor:OFFSet:AUTO?	565
[[:SENSe]:SEMAsk:DETEctor:OFFSet[:FUNctioN] AVERAge NEGAtive NORMAl POSitive SAMPle	565
[[:SENSe]:SEMAsk:DETEctor:OFFSet[:FUNctioN]?	565
[[:SENSe]:SEMAsk:FILTer[:RRC]:ALPHa <real>	548
[[:SENSe]:SEMAsk:FILTer[:RRC]:ALPHa?	548
[[:SENSe]:SEMAsk:FILTer[:RRC][:STATe] OFF ON 0 1	548
[[:SENSe]:SEMAsk:FILTer[:RRC][:STATe]?	548
[[:SENSe]:SEMAsk:FREQuency[1] 2:SPAN <freq>	522
[[:SENSe]:SEMAsk:FREQuency[1] 2:SPAN?	522

List of Commands

[[:SENSe]:SEMAsk:LIMits STD MAN	549
[[:SENSe]:SEMAsk:LIMits:TYPE MANUal NONCritical CRITical.	550
[[:SENSe]:SEMAsk:LIMits:TYPE?.	550
[[:SENSe]:SEMAsk:LIMits?	549
[[:SENSe]:SEMAsk:OFFSet[1] 2:LIST:BANDwidth:IMULti <integer>,<integer>,<integer>,<integer>,<integer>,<integer>	537
[[:SENSe]:SEMAsk:OFFSet[1] 2:LIST:BANDwidth:IMULti?.	537
[[:SENSe]:SEMAsk:OFFSet[1] 2:LIST:BANDwidth:VIDeo <freq>,<freq>,<freq>,<freq>,<freq>,<freq>	538
[[:SENSe]:SEMAsk:OFFSet[1] 2:LIST:BANDwidth:VIDeo:AUTO OFF ON 0 1,OFF ON 0 1,OFF ON 0 1,OFF ON 0 1,OFF ON 0 1,OFF ON 0 1	538
[[:SENSe]:SEMAsk:OFFSet[1] 2:LIST:BANDwidth:VIDeo:AUTO?	538
[[:SENSe]:SEMAsk:OFFSet[1] 2:LIST:BANDwidth:VIDeo:RATio <real>,<real>,<real>,<real>,<real>,<real>	539
[[:SENSe]:SEMAsk:OFFSet[1] 2:LIST:BANDwidth:VIDeo:RATio:AUTO OFF ON 0 1,OFF ON 0 1,OFF ON 0 1,OFF ON 0 1,OFF ON 0 1,OFF ON 0 1	539
[[:SENSe]:SEMAsk:OFFSet[1] 2:LIST:BANDwidth:VIDeo:RATio:AUTO?.	539
[[:SENSe]:SEMAsk:OFFSet[1] 2:LIST:BANDwidth:VIDeo:RATio?.	539
[[:SENSe]:SEMAsk:OFFSet[1] 2:LIST:BANDwidth:VIDeo?	538
[[:SENSe]:SEMAsk:OFFSet[1] 2:LIST:BANDwidth[:RESolution] <bandwidth>,<bandwidth>,<bandwidth>,<bandwidth>,<bandwidth>	536
[[:SENSe]:SEMAsk:OFFSet[1] 2:LIST:BANDwidth[:RESolution]:AUTO OFF ON 1 0,OFF ON 1 0,OFF ON 1 0,OFF ON 1 0,OFF ON 1 0,OFF ON 1 0	536
[[:SENSe]:SEMAsk:OFFSet[1] 2:LIST:BANDwidth[:RESolution]:AUTO?	536
[[:SENSe]:SEMAsk:OFFSet[1] 2:LIST:BANDwidth[:RESolution]?	536
[[:SENSe]:SEMAsk:OFFSet[1] 2:LIST:FREQuency:STARt <freq>,<freq>,<freq>,<freq>,<freq>,<freq>	530
[[:SENSe]:SEMAsk:OFFSet[1] 2:LIST:FREQuency:STARt?.	530
[[:SENSe]:SEMAsk:OFFSet[1] 2:LIST:FREQuency:STOP <freq>,<freq>,<freq>,<freq>,<freq>,<freq>	532
[[:SENSe]:SEMAsk:OFFSet[1] 2:LIST:FREQuency:STOP?	532
[[:SENSe]:SEMAsk:OFFSet[1] 2:LIST:SIDE BOTH NEGative POSitive,BOTH NEGative POSitive,BOTH NEGative POSitive,BOTH NEGative POSitive,BOTH NEGative POSitive,BO TH NEGative POSitive,BOTH NEGative POSitive.	535
[[:SENSe]:SEMAsk:OFFSet[1] 2:LIST:SIDE?	535
[[:SENSe]:SEMAsk:OFFSet[1] 2:LIST:STARt:ABSolute <real>,<real>,<real>,<real>,<real>,<real>	541
[[:SENSe]:SEMAsk:OFFSet[1] 2:LIST:STARt:ABSolute?.	541
[[:SENSe]:SEMAsk:OFFSet[1] 2:LIST:STARt:RCARrier	

List of Commands

<rel_ampl>,<rel_ampl>,<rel_ampl>,<rel_ampl>,<rel_ampl>,<rel_ampl>	543
[[:SENSe]:SEMAsk:OFFSet[1]]2:LIST:STARt:RCARrier?	543
[[:SENSe]:SEMAsk:OFFSet[1]]2:LIST:STATe ON OFF 1 0,ON OFF 1 0,ON OFF 1 0,ON OFF 1 0,ON OFF 1 0,ON OFF 1 0	530
[[:SENSe]:SEMAsk:OFFSet[1]]2:LIST:STATe?	530
[[:SENSe]:SEMAsk:OFFSet[1]]2:LIST:STOP:ABSolute <real>,<real>,<real>,<real>,<real>,<real>	542
[[:SENSe]:SEMAsk:OFFSet[1]]2:LIST:STOP:ABSolute:COUPle ON OFF 1 0,ON OFF 1 0,ON OFF 1 0,ON OFF 1 0,ON OFF 1 0,ON OFF 1 0	542
[[:SENSe]:SEMAsk:OFFSet[1]]2:LIST:STOP:ABSolute:COUPle?	542
[[:SENSe]:SEMAsk:OFFSet[1]]2:LIST:STOP:ABSolute?	542
[[:SENSe]:SEMAsk:OFFSet[1]]2:LIST:STOP:RCARrier <rel_ampl>,<rel_ampl>,<rel_ampl>,<rel_ampl>,<rel_ampl>,<rel_ampl>	545
[[:SENSe]:SEMAsk:OFFSet[1]]2:LIST:STOP:RCARrier:COUPle ON OFF 1 0,ON OFF 1 0,ON OFF 1 0,ON OFF 1 0,ON OFF 1 0,ON OFF 1 0	545
[[:SENSe]:SEMAsk:OFFSet[1]]2:LIST:STOP:RCARrier:COUPle?	545
[[:SENSe]:SEMAsk:OFFSet[1]]2:LIST:STOP:RCARrier?	545
[[:SENSe]:SEMAsk:OFFSet[1]]2:LIST:SWEEp:TIME <time>,<time>,<time>,<time>,<time>,<time>	534
[[:SENSe]:SEMAsk:OFFSet[1]]2:LIST:SWEEp:TIME:AUTO ON OFF 1 0,ON OFF 1 0,ON OFF 1 0,ON OFF 1 0,ON OFF 1 0,ON OFF 1 0	534
[[:SENSe]:SEMAsk:OFFSet[1]]2:LIST:SWEEp:TIME:AUTO?	534
[[:SENSe]:SEMAsk:OFFSet[1]]2:LIST:SWEEp:TIME?	534
[[:SENSe]:SEMAsk:OFFSet[1]]2:LIST:TEST ABSolute AND OR RELative,ABSolute AND OR RELative,ABSolute AND OR RELative,ABSolute AND OR RELative,ABSolute AND OR RELative,ABSolute AND OR RELative	547
[[:SENSe]:SEMAsk:OFFSet[1]]2:LIST:TEST?	547
[[:SENSe]:SEMAsk:SWEEp[1]]2:TIME <time>	523
[[:SENSe]:SEMAsk:SWEEp[1]]2:TIME:AUTO OFF 0 ON 1	523
[[:SENSe]:SEMAsk:SWEEp[1]]2:TIME:AUTO?	523
[[:SENSe]:SEMAsk:SWEEp[1]]2:TIME?	523
[[:SENSe]:SEMAsk:TYPE ?	521
[[:SENSe]:SEMAsk:TYPE PSDRef TPRef SPRef	521
[[:SENSe]:SLOT TS0 TS1 TS2 TS3 TS4 TS5 TS6 UPTS DPTS	1160
[[:SENSe]:SLOT?	1160
[[:SENSe]:SPURious:AVERage:COUNT <integer>	608

List of Commands

[[:SENSe]:SPURious:AVERage:COUNt?	608
[[:SENSe]:SPURious:AVERage:TCONtrol EXPonential REPeat	609
[[:SENSe]:SPURious:AVERage:TCONtrol?	609
[[:SENSe]:SPURious:AVERage[:STATe] ON OFF 1 0	608
[[:SENSe]:SPURious:AVERage[:STATe]?	608
[[:SENSe]:SPURious:CARRier:FREQuency:MS <freq>	636
[[:SENSe]:SPURious:CARRier:FREQuency:MS?	636
[[:SENSe]:SPURious:CARRier:FREQuency:STARt <freq>	633
[[:SENSe]:SPURious:CARRier:FREQuency:STARt?	633
[[:SENSe]:SPURious:CARRier:FREQuency:STOP <freq>	634
[[:SENSe]:SPURious:CARRier:FREQuency:STOP?	634
[[:SENSe]:SPURious:CARRier:POWer <real>	637
[[:SENSe]:SPURious:CARRier:POWer?	637
[[:SENSe]:SPURious:CATegory:A	630
[[:SENSe]:SPURious:CATegory:B	632
[[:SENSe]:SPURious:CATegory:MS	633
[[:SENSe]:SPURious:IF:GAIN:AUTO[:STATe] OFF ON 0 1, OFF ON 0 1	626
[[:SENSe]:SPURious:IF:GAIN:AUTO[:STATe]?	626
[[:SENSe]:SPURious:IF:GAIN[:STATe] OFF ON 0 1, OFF ON 0 1	627
[[:SENSe]:SPURious:IF:GAIN[:STATe]?	627
[[:SENSe]:SPURious:REPT:MODE ALL LIMTest	629
[[:SENSe]:SPURious:REPT:MODE?	629
[[:SENSe]:SPURious:SPUR <integer>	629
[[:SENSe]:SPURious:SPUR?	629
[[:SENSe]:SPURious:SWEp:TIME:AUTO:RULEs NORMAl ACCuracy	650
[[:SENSe]:SPURious:SWEp:TIME:AUTO:RULEs?	650
[[:SENSe]:SPURious:TDD:FREQuency:STARt <freq>	635
[[:SENSe]:SPURious:TDD:FREQuency:STARt?	635

List of Commands

OFF ON 0 1, OFF ON 0 1, OFF ON 0 1, OFF ON 0 1, OFF ON 0 1, OFF ON 0 1, OFF ON 0 1, OFF ON 0 1, OFF ON 0 1	625
[[:SENSe]:SPURious[:RANGe][:LIST]:SWEep:POINts:AUTO?	625
[[:SENSe]:SPURious[:RANGe][:LIST]:SWEep:POINts?	625
[[:SENSe]:SPURious[:RANGe][:LIST]:SWEep:TIME <seconds>, <seconds>, <seconds>, <seconds>, <seconds>, <seconds>, <seconds>, <seconds>, <seconds>, <seconds>, <seconds>, <seconds>, <seconds>, <seconds>, <seconds>, <seconds>, <seconds>, <seconds>, <seconds>	624
[[:SENSe]:SPURious[:RANGe][:LIST]:SWEep:TIME:AUTO OFF ON 0 1,OFF ON 0 1,OFF ON 0 1,OFF ON 0 1,OFF ON 0 1,OFF ON 0 1,OFF ON 0 1,OFF ON 0 1,OFF ON 0 1,OFF ON 0 1, .OFF ON 0 1,OFF ON 0 1,OFF ON 0 1,OFF ON 0 1,OFF ON 0 1,OFF ON 0 1,OFF ON 0 1,OFF ON 0 1,OFF ON 0 1,OFF ON 0 1, 1,OFF ON 0 1,OFF ON 0 1.	624
[[:SENSe]:SPURious[:RANGe][:LIST]:SWEep:TIME:AUTO?	624
[[:SENSe]:SPURious[:RANGe][:LIST]:SWEep:TIME?	624
[[:SENSe]:SWEep:EGATe:CONTRol EDGE LEVel	1246
[[:SENSe]:SWEep:EGATe:CONTRol?	1246
[[:SENSe]:SWEep:EGATe:DELay <time>	1242
[[:SENSe]:SWEep:EGATe:DELay:COMPensation:TYPE OFF SETTled GDELay	1249
[[:SENSe]:SWEep:EGATe:DELay:COMPensation:TYPE?	1249
[[:SENSe]:SWEep:EGATe:DELay?	1242
[[:SENSe]:SWEep:EGATe:HOLDoff <time>	1247
[[:SENSe]:SWEep:EGATe:HOLDoff:AUTO OFF ON 0 1	1247
[[:SENSe]:SWEep:EGATe:HOLDoff:AUTO?	1247
[[:SENSe]:SWEep:EGATe:HOLDoff?	1247
[[:SENSe]:SWEep:EGATe:LENGth <time>	1243
[[:SENSe]:SWEep:EGATe:LENGth?	1243
[[:SENSe]:SWEep:EGATe:METHod LO VIDeo FFT	1244
[[:SENSe]:SWEep:EGATe:METHod?	1244
[[:SENSe]:SWEep:EGATe:MINFast?	1250
[[:SENSe]:SWEep:EGATe:SOURce EXTernal1 EXTernal2 LINE FRAME RFBurst TV	1246
[[:SENSe]:SWEep:EGATe:SOURce?	1246
[[:SENSe]:SWEep:EGATe:TIME <time>	1241
[[:SENSe]:SWEep:EGATe:TIME?	1241
[[:SENSe]:SWEep:EGATe:VIEW ON OFF 1 0	1238

List of Commands

[[:SENSe]:SWEep:EGATe:VIEW?	1238
[[:SENSe]:SWEep:EGATe[:STATe] OFF ON 0 1	1237
[[:SENSe]:SWEep:EGATe[:STATe]?	1237
[[:SENSe]:TDEMod:ALPHa <real>	1172
[[:SENSe]:TDEMod:ALPHa?	1172
[[:SENSe]:TDEMod:CARrier:NUMber <integer>	863
[[:SENSe]:TDEMod:CARrier:NUMber?	863
[[:SENSe]:TDEMod:CARrier:RESult <integer>	864
[[:SENSe]:TDEMod:CARrier:RESult?	864
[[:SENSe]:TDEMod:CDCHannel <integer>	1169
[[:SENSe]:TDEMod:CDCHannel:ACTive <spread_code_length>,<code_channel>,0 1 OFF ON	1170
[[:SENSe]:TDEMod:CDCHannel:ACTive? <spread_code_length>,<code_channel>	1170
[[:SENSe]:TDEMod:CDCHannel:DETection AUTO MAN	1167
[[:SENSe]:TDEMod:CDCHannel:DETection?	1167
[[:SENSe]:TDEMod:CDCHannel:SALL 1 0 ON OFF	1169
[[:SENSe]:TDEMod:CDCHannel:SALL?	1169
[[:SENSe]:TDEMod:CDCHannel:SElect SINGLE ALL	1169
[[:SENSe]:TDEMod:CDCHannel:SElect?	1169
[[:SENSe]:TDEMod:CDCHannel?	1169
[[:SENSe]:TDEMod:EVMResult:IQOffset STANard EXClude	1174
[[:SENSe]:TDEMod:EVMResult:IQOffset?	1174
[[:SENSe]:TDEMod:MCARrier 1 0 ON OFF	1175
[[:SENSe]:TDEMod:MCARrier?	1175
[[:SENSe]:TDEMod:MODFormat <integer>,<integer>,AUTO QPSK PSK8 QAM16 QAM64	1171
[[:SENSe]:TDEMod:MODFormat? <integer>,<integer>	1171
[[:SENSe]:TDEMod:MODScheme:AUTO 1 0 ON OFF	1168
[[:SENSe]:TDEMod:MODScheme:AUTO?	1168
[[:SENSe]:TDEMod:MSHift <spread_code_length>,<code_channel>,<integer>	1170
[[:SENSe]:TDEMod:MSHift? <spread_code_length>,<code_channel>	1170
[[:SENSe]:TDEMod:MXUSer:TS0 <integer>	1164
[[:SENSe]:TDEMod:MXUSer:TS0?	1164

List of Commands

[:SENSe]:TDEMod:MXUSer:TS1 <integer>	1164
[:SENSe]:TDEMod:MXUSer:TS1?	1164
[:SENSe]:TDEMod:MXUSer:TS2 <integer>	1165
[:SENSe]:TDEMod:MXUSer:TS2?	1165
[:SENSe]:TDEMod:MXUSer:TS3 <integer>	1165
[:SENSe]:TDEMod:MXUSer:TS3?	1165
[:SENSe]:TDEMod:MXUSer:TS4 <integer>	1166
[:SENSe]:TDEMod:MXUSer:TS4?	1166
[:SENSe]:TDEMod:MXUSer:TS5 <integer>	1166
[:SENSe]:TDEMod:MXUSer:TS5?	1166
[:SENSe]:TDEMod:MXUSer:TS6 <integer>	1166
[:SENSe]:TDEMod:MXUSer:TS6?	1166
[:SENSe]:TDEMod:NORMAlize 1 0 ON OFF	1174
[:SENSe]:TDEMod:NORMAlize?	1174
[:SENSe]:TDEMod:PHASe:SHIFt <integer>,<integer>,<real>	1171
[:SENSe]:TDEMod:PHASe:SHIFt? <integer>,<integer>	1171
[:SENSe]:TDEMod:SCLength <integer>	1168
[:SENSe]:TDEMod:SCLength?	1168
[:SENSe]:TDEMod:SCODE <integer>	1162
[:SENSe]:TDEMod:SCODE?	1162
[:SENSe]:TDEMod:SPECTrum:MIRRor NORMAl INVert	1174
[:SENSe]:TDEMod:SPECTrum:MIRRor?	1174
[:SENSe]:TDEMod:SREFerence PILot MIDamble	1167
[:SENSe]:TDEMod:SREFerence?	1167
[:SENSe]:TDEMod:SYNC PILot MIDamble	1163
[:SENSe]:TDEMod:SYNC?	1163
[:SENSe]:TDEMod:THReshold:CHANnel <real>	1173
[:SENSe]:TDEMod:THReshold:CHANnel:AUTO ON OFF 0 1	1173
[:SENSe]:TDEMod:THReshold:CHANnel:AUTO?	1173
[:SENSe]:TDEMod:THReshold:CHANnel?	1173
[:SENSe]:TDEMod:THReshold:SLOT <real>	1173

List of Commands

[[:SENSe]:TDEMod:THReshold:SLOT?	1173
[[:SENSe]:TDEMod:TREFeRence DPTS UPTS TRIG	1172
[[:SENSe]:TDEMod:TREFeRence?	1172
[[:SENSe]:TDEMod:ULSPoInt <integer>.	1164
[[:SENSe]:TDEMod:ULSPoInt?	1164
[[:SENSe]:TDEMod:UPTS <integer>.	1162
[[:SENSe]:TDEMod:UPTS?	1162
[[:SENSe]:TXPower:AVERAge:COUNt <integer>.	317
[[:SENSe]:TXPower:AVERAge:COUNt?	317
[[:SENSe]:TXPower:AVERAge:TCONtrol EXPoNential REPeat	318
[[:SENSe]:TXPower:AVERAge:TCONtrol?	318
[[:SENSe]:TXPower:AVERAge:TYPE LOG MAXimum MINimum RMS	319
[[:SENSe]:TXPower:AVERAge:TYPE LOG RMS	319
[[:SENSe]:TXPower:AVERAge:TYPE?	319
[[:SENSe]:TXPower:AVERAge:TYPE?	319
[[:SENSe]:TXPower:AVERAge[::STATe] OFF ON 0 1	317
[[:SENSe]:TXPower:AVERAge[::STATe]?	317
[[:SENSe]:TXPower:BANDwidth:TYPE GAUSSian FLATtop	304
[[:SENSe]:TXPower:BANDwidth:TYPE?	304
[[:SENSe]:TXPower:BANDwidth[::RESolution] <bandwidth>	303
[[:SENSe]:TXPower:BANDwidth[::RESolution]?	303
[[:SENSe]:TXPower:BURSt:AUTO ON OFF 1 0	322
[[:SENSe]:TXPower:BURSt:AUTO?	322
[[:SENSe]:TXPower:BURSt:WIDTh <time>	322
[[:SENSe]:TXPower:BURSt:WIDTh?	322
[[:SENSe]:TXPower:IF:GAIN:AUTO[::STATe] OFF ON 0 1	323
[[:SENSe]:TXPower:IF:GAIN:AUTO[::STATe]?	323
[[:SENSe]:TXPower:IF:GAIN[::STATe] ON OFF 1 0	324
[[:SENSe]:TXPower:IF:GAIN[::STATe]?	324
[[:SENSe]:TXPower:METHod THReshold BWIDth SINGLE.	321
[[:SENSe]:TXPower:METHod THReshold BWIDth	321

List of Commands

[::SENSe]:TXPower:METhod?	321
[::SENSe]:TXPower:METhod?	321
[::SENSe]:TXPower:SWEEp:TIME <integer>	325
[::SENSe]:TXPower:SWEEp:TIME <integer>	338
[::SENSe]:TXPower:SWEEp:TIME <time>	338
[::SENSe]:TXPower:SWEEp:TIME?	325
[::SENSe]:TXPower:SWEEp:TIME?	338
[::SENSe]:TXPower:SWEEp:TIME?	338
[::SENSe]:TXPower:THREshold <real>	320
[::SENSe]:TXPower:THREshold:TYPE ABSolute RELAtive	320
[::SENSe]:TXPower:THREshold:TYPE?	320
[::SENSe]:TXPower:THREshold?	320
[::SENSe]:VOLTage:IQ:Q:RANGe[:UPPer] <voltage>	1047
[::SENSe]:VOLTage:IQ:Q:RANGe[:UPPer]?	1047
[::SENSe]:VOLTage:IQ:RANGe:AUTO OFF ON 0 1	1044
[::SENSe]:VOLTage:IQ:RANGe:AUTO?	1044
[::SENSe]:VOLTage:IQ[:I]:RANGe[:UPPer] <voltage>	1045
[::SENSe]:VOLTage:IQ[:I]:RANGe[:UPPer]?	1045
[::SENSe]:VOLTage POWER:IQ:MIRROred OFF ON 0 1	1047
[::SENSe]:VOLTage POWER:IQ:MIRROred?	1047
[::SENSe]:WAVEform:ADC:DITHer:AUTO[:STATe] OFF ON 0 1	969
[::SENSe]:WAVEform:ADC:DITHer:AUTO[:STATe]?	969
[::SENSe]:WAVEform:ADC:DITHer[:STATe] OFF ON 0 1	970
[::SENSe]:WAVEform:ADC:DITHer[:STATe]?	970
[::SENSe]:WAVEform:AVERAge:COUNt <integer>	966
[::SENSe]:WAVEform:AVERAge:COUNt?	966
[::SENSe]:WAVEform:AVERAge:TCONtrol EXPonential REPeat	967
[::SENSe]:WAVEform:AVERAge:TCONtrol?	967
[::SENSe]:WAVEform:AVERAge:TYPE LOG MAXimum MINimum RMS SCALAr	967
[::SENSe]:WAVEform:AVERAge:TYPE?	967
[::SENSe]:WAVEform:AVERAge[:STATe] OFF ON 0 1	966

List of Commands

[:SENSe]:WAVeform:AVERage[:STATe]?	966
[:SENSe]:WAVeform:BANDwidth:SHAPE GAUSSian FLATtop	942
[:SENSe]:WAVeform:BANDwidth:SHAPE?	942
[:SENSe]:WAVeform:BANDwidth[:RESolution] <freq>	941
[:SENSe]:WAVeform:BANDwidth[:RESolution]?	941
[:SENSe]:WAVeform:IF:GAIN:AUTO[:STATe] ON OFF 1 0	971
[:SENSe]:WAVeform:IF:GAIN:AUTO[:STATe]?	971
[:SENSe]:WAVeform:IF:GAIN[:STATe] AUTO Orange LOW HIGH	971
[:SENSe]:WAVeform:IF:GAIN[:STATe]?	971
[:SENSe]:WAVeform:SWEEp:TIME <time>	968
[:SENSe]:WAVeform:SWEEp:TIME?	968
CONFIgure:EVM:NDEFault	837
CONFIgure:EVM	837
FETCh:EVM[n]?	837
INITiate:EVM	837
MEASure:EVM[n]?	837
READ:EVM[n]?	837
Type of number includes double, float and integer.	837

Welcome to the X-Series Signal Analyzer Help system!

The online Help system is "context-sensitive". This means that the information displayed when you invoke the Help system depends on the selected Analyzer Mode, Measurement and key.

TIP

To view help for any Front-panel key or menu key, press that key with this Help Window open.

To scroll any page vertically (to see the whole of a long topic), press the **Down Arrow** key on the Front Panel to scroll down (or the **Up Arrow** key to scroll up). To locate these keys, see [“Front Panel Keys used by the Help System” on page 101](#).

See [“Navigating the Help Window Without a Mouse” on page 106](#) for complete information about **Using Help without an attached Mouse and Keyboard**. For specific details of how to navigate to topics, see [“Finding a Topic without a Mouse and Keyboard” on page 115](#).

See [“Navigating the Help Window with a Mouse” on page 104](#) to learn about **Using Help with an attached Mouse and Keyboard**.

You can view Help on the Analyzer itself, or you can **View Help on Another Computer**, by copying the Help files and viewing Help there. For details, see the Section [“Viewing Help on a separate Computer” on page 95](#).

To locate **Other Available Help Resources**, see [“Locating Other Help Resources” on page 94](#).

Key Path

Help

Locating Other Help Resources

All available documentation is present on the Analyzer's hard disk, either as HTML Help or Acrobat PDF files.

In addition to the interactive Windows (HTML) Help system, the Analyzer's hard disk contains Application Notes, tutorial documents, etc.

This same documentation is also included on the Documentation CD shipped with your Analyzer.

Many of the supporting documents use the Adobe Acrobat (PDF) file format. You can view PDF files using the pre-installed Adobe Reader software.

The Adobe Reader user interface differs from the Windows Help interface. For full details on how to navigate within Acrobat documents using Adobe Reader, see [“Navigating Acrobat \(PDF\) Files”](#) on page 110.

Viewing Help on a separate Computer

You may want to view the help pages *without* having them appear on top of the Analyzer's screen.

There are two separate Help files for each Analyzer Mode, which contain all the same help pages in different formats:

1. A file in HTML Help (CHM) format,
2. A file in Acrobat (PDF) format.

You can copy any of the Help files to another computer, then open and view the help pages in the file on that computer.

Your choice of which file to copy and view may depend on what you want to do with the file (for example, whether you want to print it and read the paper copy, or view it on the computer). The table below compares the relative advantages of the two formats:

Format Type	HTML Help Format (CHM Files)	Acrobat Format (PDF Files)
File Extension	CHM	PDF
Software Required to view file	Microsoft Windows operating system only, with Microsoft Internet Explorer installed.	Free Adobe Reader software can be downloaded for many operating systems, including: Microsoft Windows, Macintosh, Linux, Solaris.
Full Text Search?	Yes	Yes
Printable?	Yes, but with limited control.	Yes. Full print control.
Printable Table of Contents?	No	Yes
Navigable without a Mouse and Keyboard?	Yes, but with some loss of functionality.	No
Has Page Numbers?	No	Yes
Context-Sensitive Display?	Yes, when viewed using the X-Series Analyzer application window.	No
Indexed?	Yes	No
Active Hyperlinks?	Yes	Yes

Copying the HTML Help (CHM) Files

You can copy the HTML Help file(s) you need to a separate computer running Microsoft Windows. Each HTML Help file has a .chm extension.

You can find the HTML Help (.chm) files:

- *Either*, on the documentation CD that came with the Analyzer,

- Or, in a special directory on the Analyzer's hard disk. The directory path is:
C:\Program Files\Agilent\SignalAnalysis\Infrastructure\Help
The illustration below shows an example listing of the HTML Help files in this directory, viewed using Windows Explorer.
Depending on which Analyzer software licenses you purchased, the content of the directory on your machine may vary.

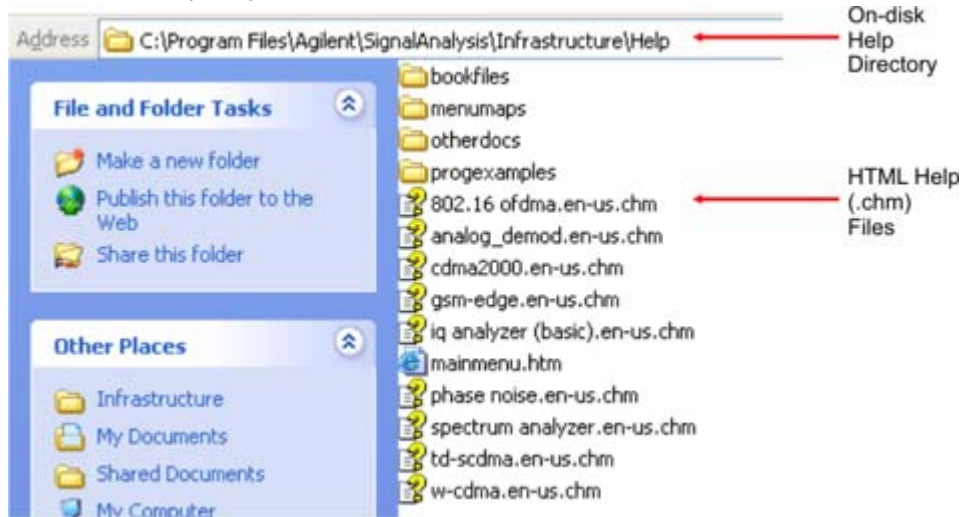

NOTE You can open and view the HTML Help files only on a PC that has Microsoft Windows and Microsoft Internet Explorer installed.

Copying the Acrobat (PDF) Files

You can copy the Acrobat file(s) you need to a separate computer running any of several different operating systems. Each Acrobat file has a .pdf extension.

You can find the Acrobat (.pdf) files:

- Either, on the documentation CD that came with the Analyzer,
- Or, in a special directory on the Analyzer's hard disk. The directory path is:
C:\Program Files\Agilent\SignalAnalysis\Infrastructure\Help\bookfiles
 - The illustration below shows an example listing of the Acrobat files in this directory, viewed using Windows Explorer.
 - The PDF versions of the help files are named <mode>_ref.pdf, where <mode> is the name of the Analyzer Mode. For example, the name of the PDF file for GSM/EDGE Mode is gsmedge_ref.pdf. (Note that the directory also contains other PDF documents.)
 - When you open any <mode>_ref.pdf document, the title page displays "<Mode> User's and Programmer's Reference", where <Mode> is the name of the Analyzer Mode described by the document.
 - Depending on which Analyzer software licenses you purchased, the content of the directory on your machine may vary.

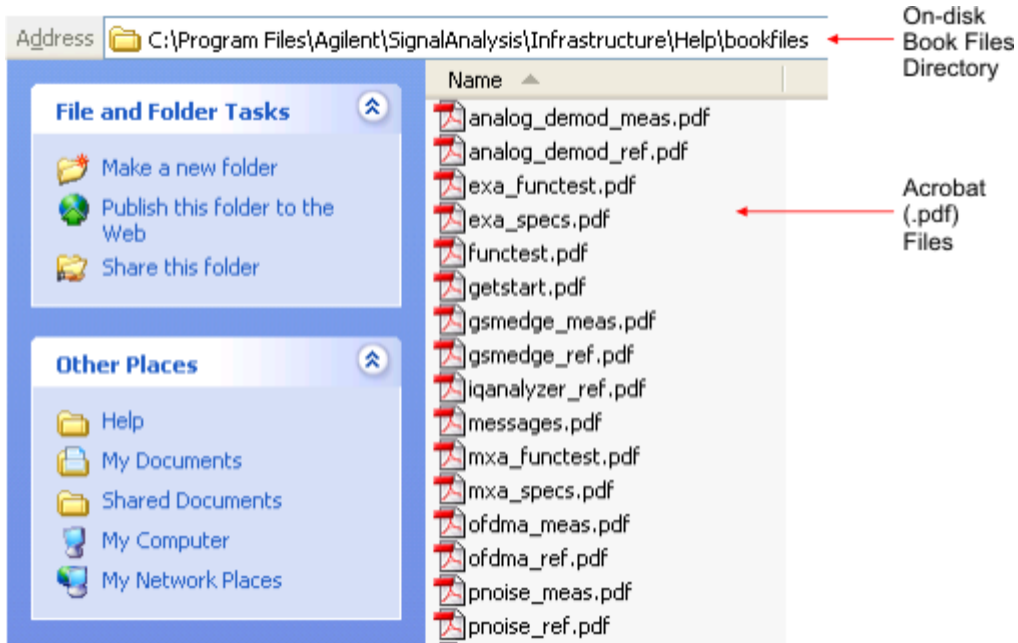

How Help is Organized

This topic contains the following sections:

“Help Contents Listing” on page 98

“System Functions” on page 98

“Key Descriptions for Each Measurement” on page 99

“Key Information for Softkeys” on page 99

“Common Measurement Functions” on page 100

Help Contents Listing

The listing under the Contents tab in the Help Window includes a topic for each Front-panel key and each softkey, for each available measurement.

The Contents listing is split into several major sections, as shown below for the HTML Help version of the document. The structure of the PDF version is similar.

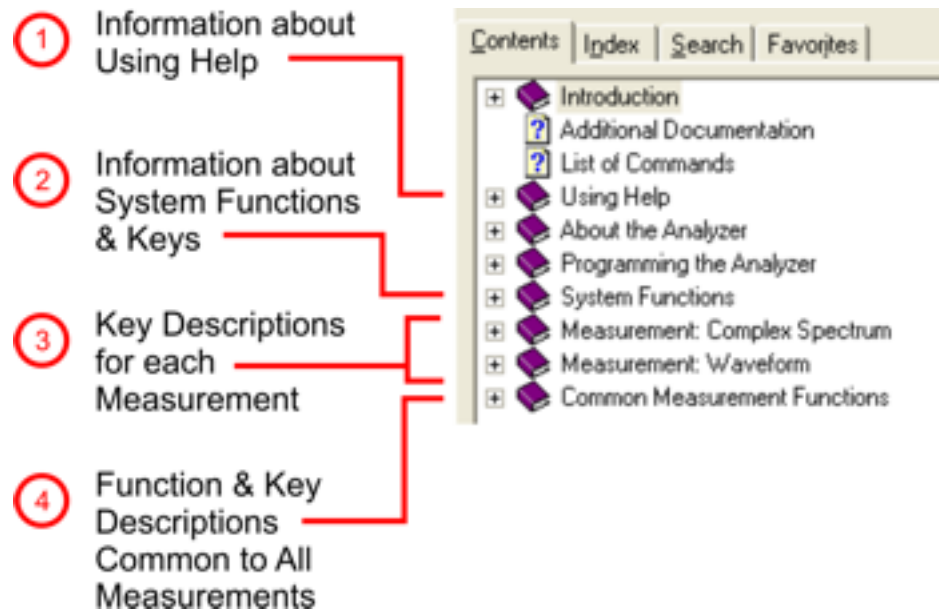

Help information is split between these sections as follows:

1. Using Help: this section.
2. System Functions. See “System Functions” on page 98 below.
3. Measurement Functions. See “Key Descriptions for Each Measurement” on page 99 below.
4. Common Measurement Functions. See “Common Measurement Functions” on page 100 below.

System Functions

This section contains information for the following keys, which are listed in alphabetical order: **File**,

Preset, Print, Quick Save, Recall, Save, System, User Preset.

The functions of these keys do not vary between measurements: they operate the same way, irrespective of which Analyzer measurement you have selected.

The sections for **Recall** and **Save** contain only cross-references to the respective sections in “[Common Measurement Functions](#)” on page 100, and are included here for convenience.

Key Descriptions for Each Measurement

The Contents section for each Measurement is sub-divided into topics for each Front-panel key, in alphabetical order, as shown below.

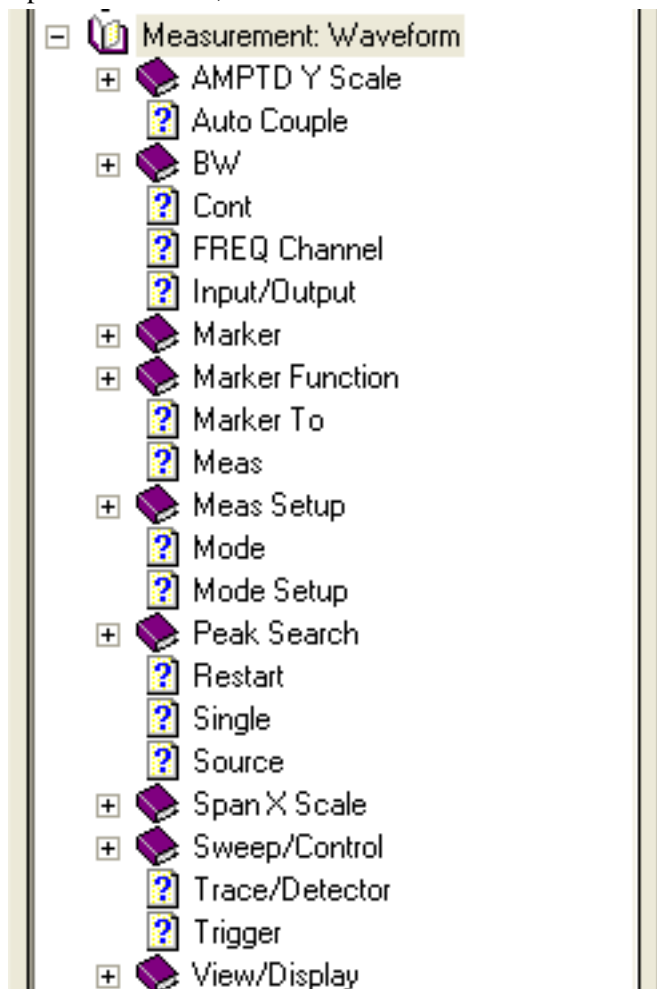

If you don't see a topic for a Front-panel key in the Measurement-specific section, then it is located in the section “[System Functions](#)” on page 98.

Key Information for Softkeys

Information for each softkey that appears when you press a Front-panel key (or a softkey with a submenu) is listed under the entry for that key in the Help Contents. The example below shows the submenu under the **SPAN X Scale** Front-panel key in the "Waveform" Measurement, alongside the

Using Help How Help is Organized

actual softkeys for that menu.

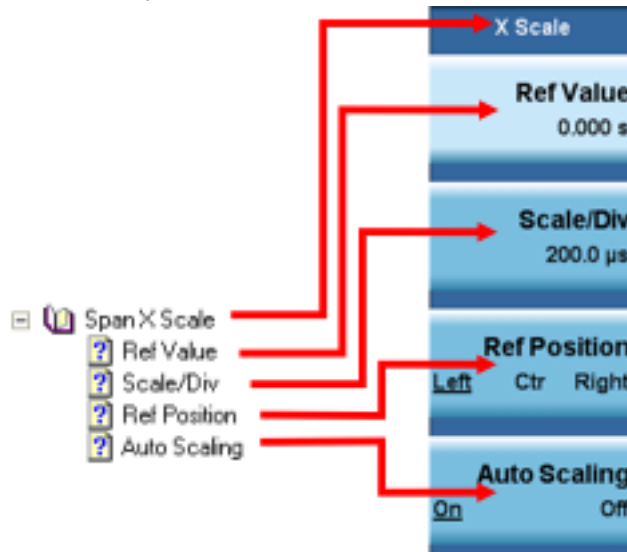

In these subsections, all softkeys are listed in the order they appear in their menu (that is, *not* in alphabetical order).

Common Measurement Functions

This section groups together function and key information that is shared between measurements. However, there is a listing for every Front-panel key and subkey in the section for each measurement, so you will generally not need to refer to this section.

The key subsections are listed alphabetically.

Front Panel Keys used by the Help System

The interactive Help system uses the Front-panel keys shown below.

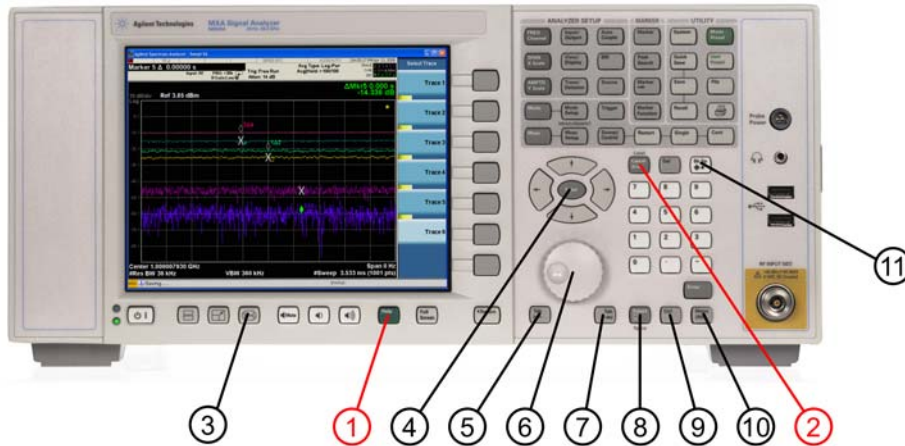

#	Item Name	Description
1	Help Key	Opens Help (displaying the topic for the last key pressed).
2	Cancel (Esc) Key	Exits Help.
3	Next Window Key	Changes the current window pane selection.
4	Arrow / Enter Keys	A central Enter key, surrounded by four directional arrow keys. Navigates within the Help system.
5	Backward Tab Key	Moves between controls in the Help display.
6	Knob	For future use.
7	Forward Tab Key	Moves between controls in the Help display.
8	Select / Space Key	Navigates within the Help system, in conjunction with other keys.
9	Ctrl Key	Navigates within the Help system, in conjunction with other keys. See “Navigating Windows HTML Help (CHM) Files” on page 102.
10	Alt Key	Navigates within the Help system, in conjunction with other keys. See “Navigating Windows HTML Help (CHM) Files” on page 102.
11	Bk Sp (Backspace) Key	Acts as a "Back" key when navigating the pages of the Help system.

Navigating Windows HTML Help (CHM) Files

HTML Help Window Components

When the interactive Help Window is open, the Analyzer's display appears as below.

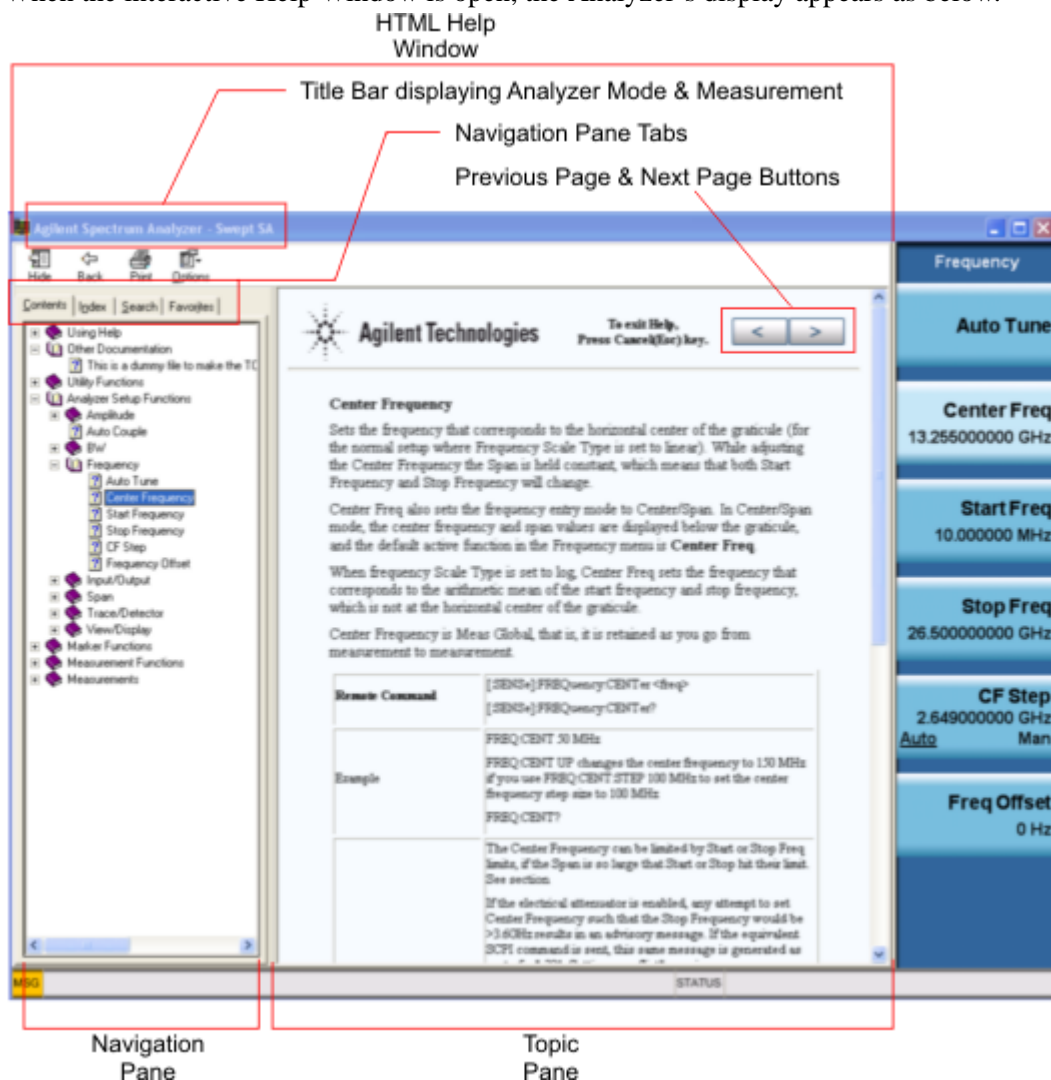

The HTML Help Window appears on top of, and to the left of, the measurement display. You can still see and use the current softkey menu when the HTML Help Window is open. However, pressing a softkey when the Help window is open displays Help for that softkey, but does *not* execute the softkey's function.

When the Help Window is open, the Analyzer retains its current Mode and Measurement, as shown in the Title Bar.

The HTML Help Window itself consists of two panes, as shown in the diagram above.

On the left is the Navigation Pane, and on the right is the Topic Pane.

The Help Window Navigation Pane

The Navigation Pane is further divided into four tabs: Contents, Index, Search and Favorites, as shown below.



For details of how to switch between these tabs, if you don't have a mouse attached to the Analyzer, see the Section [“To Switch the Active Tab within the Navigation Pane” on page 106](#).

The Help Window Topic Pane

This pane displays the text for the topic that you have selected. It also contains clickable **Previous Page** and **Next Page** buttons (as shown below), which can be used to move to the previous or next page in the Help file.



Basic Help Window Operations

This topic contains the following sections:

[“Opening Help” on page 103](#)

[“Getting Help for a Specific Key” on page 103](#)

[“Closing the Help Window” on page 104](#)

[“Viewing Help on How to Use Help” on page 104](#)

[“Exiting Help on How to Use Help” on page 104](#)

To locate the keys mentioned in this section, see [“Front Panel Keys used by the Help System” on page 101](#).

Opening Help

To access the Help system, press the green **Help** key below the front panel display (shown below) while an Agilent application is running.



Note that the softkeys remain visible when the Help window is open.

Getting Help for a Specific Key

1. If the Help window *is* already open, press the desired key. The relevant Help topic appears.

Note that the function normally invoked by the key is *not* executed when the key is pressed with the Help window open. If you want to execute the key's function, first close Help by pressing the **Cancel (Esc)** key (as described in [“Closing the Help Window” on page 104](#)), then press the key, before opening Help again (if required).

2. If the Help window is *not* already open, press the desired key (which executes the key's function), then press the **Help** key to display the relevant Help page. Help is available for all softkeys, and for

Using Help

Navigating Windows HTML Help (CHM) Files

all the Front-panel keys listed under the "System Functions" and "Measurement" sections.

For details of how to navigate within the panes of the Help window, see “[Navigating Windows HTML Help \(CHM\) Files](#)” on page 102.

Closing the Help Window

To close the Help window, and return to the measurement application, press the **Cancel (Esc)** key (depicted below).



Viewing Help on How to Use Help

With the Help window open, press the green **Help** key again.

The "Using Help" page appears, as shown below.



Exiting Help on How to Use Help

See the Section “[To Go Back or Forward: display the Previously-viewed or Next-viewed Topic in the Topic Pane](#)” on page 108 for details of several methods to accomplish this.

Navigating the Help Window

The way you navigate around the HTML Help Window depends on whether you have a mouse and keyboard attached to your Analyzer:

- If you have a mouse and keyboard attached, see the Section “[Navigating the Help Window with a Mouse](#)” on page 104.
- If you don't have a mouse and keyboard attached, see the Section “[Navigating the Help Window Without a Mouse](#)” on page 106.

Navigating the Help Window with a Mouse

When the HTML Help window is open, you can point-and-click to navigate, as you would when using Help for any Microsoft Windows computer application. The basic navigational features the Help systems of all X-Series Analyzers are as follows:

- If necessary, press the green **Help** key on the Front Panel, as described in “[Opening Help](#)” on page 103, to open the HTML Help window.

- Choose the desired topic from the list under the Contents Tab of the HTML Help Window's Navigation Pane, then click on the topic title to display the first page of the topic.
- To expand the listing of a topic, click on the + icon to the left of the topic's book icon, as shown below. A list of subtopics and pages appears.

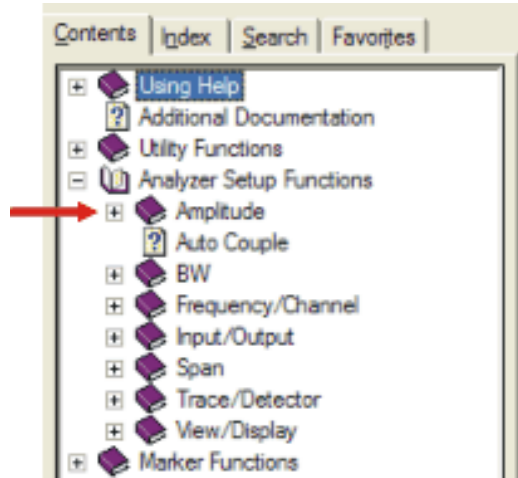

- To move to the Next or Previous Page within the Topic Pane, click the **Next Page** or **Previous Page** Keys (at the top right of the *Topic* Pane), as shown below.



Searching for a Help Topic If you also have a keyboard attached to the Analyzer, you can use the Help system's full-text search feature to locate help for any topic, by typing in a key name, a topic name, or any other desired text.

Select the "Search" tab of the Help window's Navigation Pane, then use the following procedure:

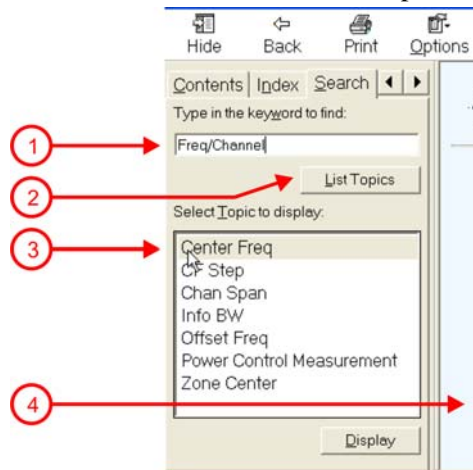

1. Type the desired topic name into the Search window as shown in the diagram above. Note that the text search is *not* case-sensitive.
2. Click on the **List Topics** button.
3. *Either:*
Double-click on the desired topic in the list,

Or:

Click on the desired topic to select it, then click the **Display** button beneath the list.

4. The topic is then displayed in the Topic Pane (right-hand side of display).

Navigating the Help Window Without a Mouse

Most features of the Help system can be accessed and navigated without the necessity to attach a mouse or keyboard to the Analyzer. There are, however, a few exceptions to this rule, which are noted in the Section [“Functions that cannot be used without a Mouse and Keyboard”](#) on page 109.

For information about how to perform common tasks in the Help system, click on one of the following links:

[“To Toggle the Focus between the Navigation Pane and the Topic Pane”](#) on page 106

[“To Switch the Active Tab within the Navigation Pane”](#) on page 106

[“To Scroll up or down the list of Topics within the Contents or Index Tabs of the Navigation Pane”](#) on page 107

[“To Expand or Collapse a selected topic within the Contents Tab of the Navigation Pane”](#) on page 107

[“To Display a selected Help topic in the Topic Pane from the Contents Tab of the Navigation Pane”](#) on page 107

[“To Display a Help topic in the Topic Pane from the Index Tab of the Navigation Pane”](#) on page 107

[“To Scroll up or down within a topic in the Topic Pane”](#) on page 107

[“To Go to the Next or Previous Page in the Topic Pane”](#) on page 108

[“To Go Back or Forward: display the Previously-viewed or Next-viewed Topic in the Topic Pane”](#) on page 108

[“To Scroll horizontally or vertically within the Contents Tab of the Navigation Pane”](#) on page 109

[“To Print the topic currently displayed”](#) on page 109

To locate all the keys mentioned in this section, see [“Front Panel Keys used by the Help System”](#) on page 101.

To Toggle the Focus between the Navigation Pane and the Topic Pane Press the **Next Window** key.



To Switch the Active Tab within the Navigation Pane Perform this procedure to display either the Contents, Index, Search or Favorites tab of the Help window’s Navigation Pane.

Hold down the **Ctrl** key, then press either the **Forward Tab** key, *or* the **Backward Tab** key.

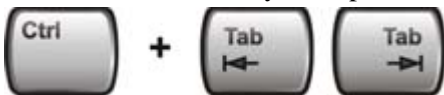

To Scroll up or down the list of Topics within the Contents or Index Tabs of the Navigation Pane

With the focus in the Navigation Pane, press the **Up Arrow** or **Down Arrow** keys.

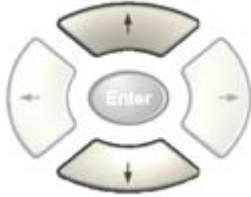

To Expand or Collapse a selected topic within the Contents Tab of the Navigation Pane With the focus in the Navigation Pane, press the **Right Arrow** key to *expand* the selected topic:



Or press the **Left Arrow** key to *collapse* the selected topic.

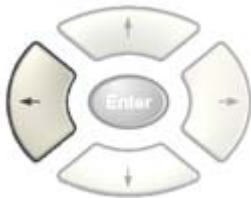

To Display a selected Help topic in the Topic Pane from the Contents Tab of the Navigation Pane

With the focus in the Contents Tab of the Navigation Pane, press the **Enter** key. If the selected topic was not already expanded, it expands in the Navigation Pane.



To Display a Help topic in the Topic Pane from the Index Tab of the Navigation Pane With the focus in the Index Tab of the Navigation Pane, press the **Enter** key.



To Scroll up or down within a topic in the Topic Pane With the focus in the Topic Pane, press either

the **Up Arrow** key or **Down Arrow** key.



To Go to the Next or Previous Page in the Topic Pane With the focus in the Topic Pane, press either **Forward Tab** or **Backward Tab** keys



to select the **> (Next Page)** key at the top right of the Pane, if you want to go to the *next* page,



or select the **< (Previous Page)** key at the top right of the Pane, if you want to go to the *previous* page.



Press **Enter**.



To Go Back or Forward: display the Previously-viewed or Next-viewed Topic in the Topic Pane

To go *back*, either:

Hold down the **Alt** key, then press the **Left Arrow** key.

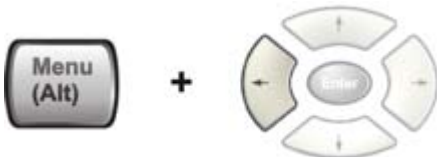

Or:

Press the **Bk Sp** key.



To go *forward*, hold down the **Alt** key, then press the **Right Arrow** key.

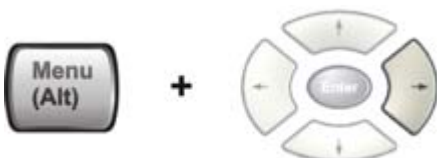

(The "Go Forward" operation has no effect unless there have been previous "Go Back" operations)

To Scroll horizontally or vertically within the Contents Tab of the Navigation Pane To scroll *horizontally*: with the focus in the Contents Tab of the Navigation Pane, hold down the **Ctrl** key, then press either the **Left Arrow** or **Right Arrow** keys.

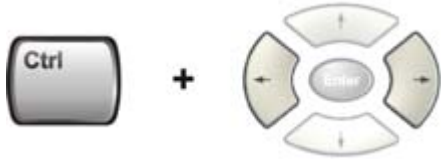

To scroll *vertically*: with the focus in the Contents Tab of the Navigation Pane, hold down the **Ctrl** key, then press either the **Up Arrow** or **Down Arrow** keys.

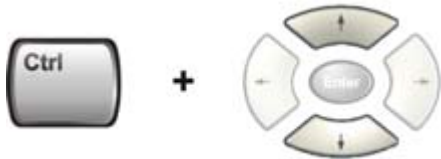

To Print the topic currently displayed Press the Front-panel **Print** key



Functions that cannot be used without a Mouse and Keyboard The following parts of the HTML Help System *cannot* easily be used without attaching a mouse and keyboard to the Analyzer.

- The menu options at the top of the Help Window, consisting of: **Hide**, **Back**, **Print** and **Options**.
- The functionality of the Search Tab of the Navigation Pane.
- The functionality of the Favorites Tab of the Navigation Pane.

Navigating Acrobat (PDF) Files

IMPORTANT To navigate PDF files effectively, you must attach a mouse and keyboard to the Analyzer.

If it is not possible to attach a mouse and keyboard to the Analyzer, you should copy the PDF file to a separate computer, then open it on that computer. Every PDF file that is present on the Analyzer's hard disk can also be found on the Documentation CD shipped with the Analyzer. For details, see ["Copying the Acrobat \(PDF\) Files" on page 96](#).

Adobe Reader Window

When an Adobe Acrobat (PDF) file is open and being viewed, the Analyzer's display appears as below.

Note that, unlike the HTML Help Window, the Acrobat Reader Window is *not* embedded in the Analyzer's Application window. It is a separate window, which can be resized, moved and closed independently of the Application window.

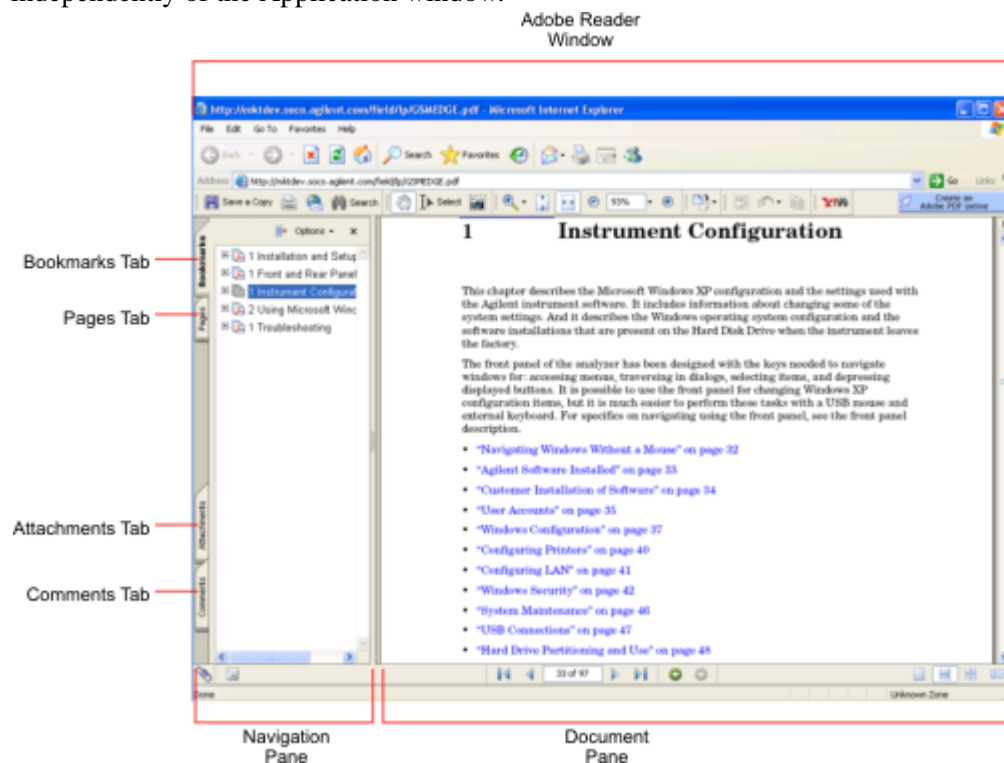

The Adobe Reader Window itself consists of two panes, as shown in the diagram above.

On the left is the Navigation Pane (which may be hidden), and on the right is the Document Pane.

The Navigation Pane is further subdivided into four tabs: Bookmarks, Pages, Attachments and Comments. Typically, PDF files supplied with the Agilent X-Series Analyzers contain useful content only under the Bookmarks and Pages Tabs: the Attachments and Comments Tabs are not used.

Navigating the Acrobat Reader Window

The online Help for Adobe Reader provides detailed information on how to use the Reader. To access the online Help, do the following:

- With the Adobe Reader window open, click **Help, Adobe Reader Help** in the menu at the top of the screen. This opens the Help window on top of the document window.
- To close the Help window, *either* click the Red **X** at the top right of the window, *or* right-click



anywhere in the title bar, then select **Close** from the popup menu.

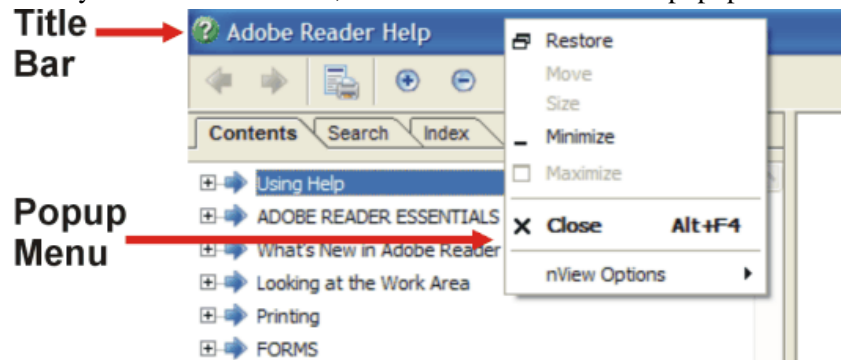

Printing Acrobat Files

NOTE The driver for the appropriate printer must be installed on the Analyzer's hard disk before any file can be printed.

To print all or part of an open Acrobat file, do the following.

1. *Either*,
 - a. click on the Print icon in the Acrobat Reader toolbar,



- b. *or*, select File > Print from the menu.

Using Help
Navigating Acrobat (PDF) Files

2. The Acrobat Reader Print dialog opens, as shown below.

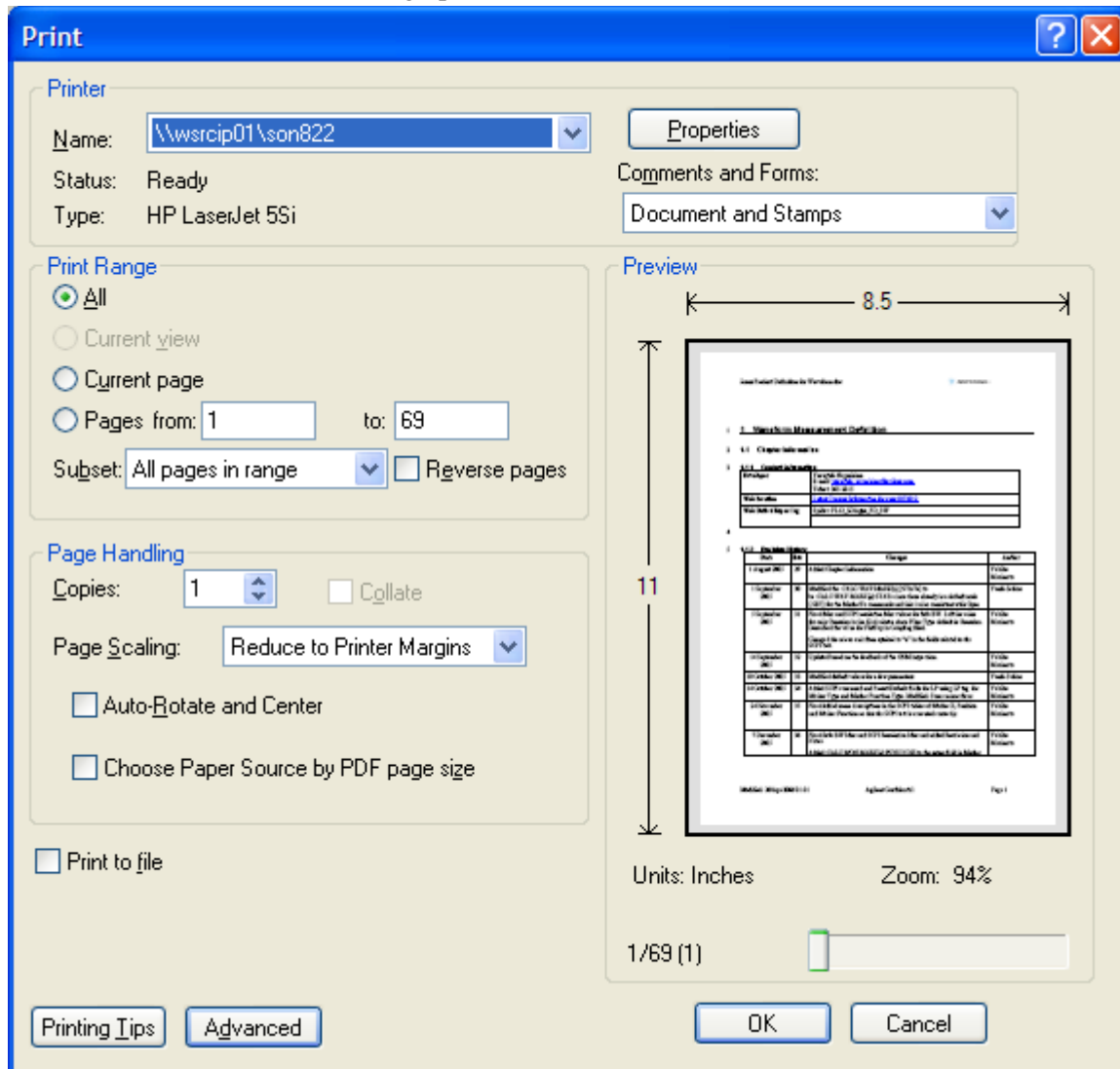

3. Choose the desired options within the Print dialog, then click OK to print (or click Cancel to cancel the printing).

NOTE Clicking the **Properties** button within the Print dialog opens a window containing controls that are specific to the printer model installed. Check the printer manufacturer’s documentation for details of these capabilities.

Terms Used in This Documentation

Many special terms are used throughout this documentation. Please refer to the "Getting Started Guide" for detailed explanations of all these terms.

The Section below provides a brief description of special terms used in the Key parameter tables.

Terms used in Key Parameter Tables

The following terms are used in the parameter tables for each Front-panel key or softkey. However, a particular key description may not use all the terms listed.

Term	Meaning
Default Unit	The default measurement unit of the setting.
Default Terminator	Indicates the units that will be attached to the numeric value that you have entered. This default will be used from the front panel, when you terminate your entry by pressing the Enter key, rather than selecting a units key. This default will be used remotely when you send the command without specifying any units after your value(s).
Dependencies/ Couplings	Some commands may be unavailable when other parameters are set in certain ways. If applicable, any such limitations are described here.
Example	Provides command examples using the indicated remote command syntax.
Factory Preset	Describes the function settings after a Factory Preset .
Key Path	The sequence of Front-panel keys that accesses the function or setting.
Knob Increment/Decrement	The numeric value of the minimum increment or decrement that is applied when turning the thumb wheel knob.
Max	The Maximum numerical value that the setting can take.
Min	The Minimum numerical value that the setting can take.
Meas Global	The functionality described is the same in all measurements.
Meas Local	The functionality described is only true for the measurement selected.
Mode Global	The functionality described is the same for all modes.
Preset	In some cases, a Preset operation changes the status of a parameter. If the operation of the key specified is modified by a Preset operation, the effect is described here.
Range	Describes the range of the smallest to largest values to which the function can be set. If you try to set a value below the minimum value, the analyzer defaults to the minimum value. If you try to set a value above the maximum value, the analyzer defaults to the maximum value.
Remote Command	Shows the syntax requirements for each SCPI command.

Using Help
Terms Used in This Documentation

Term	Meaning
Remote Command Notes	Additional notes regarding Remote Commands.
Resolution	Specifies the smallest change that can be made to the numeric value of a parameter.
SCPI Status Bits/OPC Dependencies	Pressing certain keys may affect one or more status bits. If applicable, details are given here.
State Saved	Indicates what happens to a particular function when the Analyzer state is saved (either to an external memory device or the internal D: drive). It also indicates whether the current settings of the function are maintained if the Analyzer is powered on or preset using Power On Last State or User Preset .

Context Sensitive Help not Available

You have been directed to this page because interactive help for the key you selected is not available.



The following information may help you to find related topics of interest:

- If your Analyzer has an attached Mouse and Keyboard, see the Section [“Searching for a Help Topic” on page 105](#).
- If your Analyzer does *not* have an attached Mouse and Keyboard, see the Section [“Finding a Topic without a Mouse and Keyboard” on page 115](#) below.
- If you want to learn how to select on-page links *without* a Mouse attached to your Analyzer, see the Section [“Selecting a Hyperlink without a Mouse” on page 116](#) below.

TIP If you want to understand the organization of Help, see the Section [“How Help is Organized” on page 98](#).



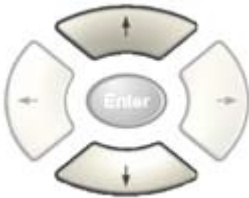

Finding a Topic without a Mouse and Keyboard

Follow this procedure when you want to display a different Help topic by selecting it from the Contents tab of the Help window’s Navigation Pane, but you do not have a mouse attached to the Analyzer.

Perform this action:	Using these keys:
<p>1. If necessary, toggle the focus between the Contents tab of the Navigation Pane (left side of display) and the Topic Pane (right side of display) by pressing the Next Window key.</p> <p>Ensure that the focus is in the <i>Contents tab of the Navigation Pane</i>.</p>	
<p>2. Move up or down the Contents list, by pressing the Up Arrow or Down Arrow keys. Topics become highlighted upon selection.</p>	
<p>3. Display the selected topic, by pressing the Enter key.</p>	

Selecting a Hyperlink without a Mouse

Follow this procedure when you want to select and follow a hyperlink on a Help page, but you do not have a mouse attached to the Analyzer.

Perform this action:	Using these keys:
<p>1. If necessary, toggle the focus between the Contents tab of the Navigation Pane (left side of display) and the Topic Pane (right side of display) by pressing the Next Window key.</p> <p>Ensure that the focus is in the <i>Topic Pane</i>.</p>	
<p>2. Move from link to link in the Topic Pane (right side of display) by pressing the Forward Tab and Backward Tab keys. Links become highlighted upon selection.</p> <p>NOTE: When a Help page is first displayed, no link is selected. Clicking the Forward Tab key once selects the Previous Page key. Clicking the Forward Tab key a second time selects the Next Page key. Clicking the Forward Tab key for a third time selects the first hyperlink on the page.</p> <p>It is sometimes difficult to see the highlighting of the Previous and Next Page keys.</p>	<p>Use the Forward and Backward Tab keys</p>  <p>to select the Previous and Next Page keys</p> 
<p>3. When you have selected the desired link, activate it by pressing the Enter key.</p>	

The X-Series signal analyzer measures and monitors complex RF and microwave signals. Analog baseband analysis is available on MXA. The analyzer integrates traditional spectrum measurements with advanced vector signal analysis to optimize speed, accuracy, and dynamic range. The analyzer has Windows XP Pro[®] built in as an operating system, which expands the usability of the analyzer.

With a broad set of applications and demodulation capabilities, an intuitive user interface, outstanding connectivity and powerful one-button measurements, the analyzer is ideal for both R&D and manufacturing engineers working on cellular, emerging wireless communications, general purpose, aerospace and defense applications.

Installing Application Software

When you want to install a measurement application after your initial hardware purchase, you actually only need to license it. All of the available applications are loaded in your analyzer at the time of purchase.

So when you purchase an application, you will receive an entitlement certificate that is used to obtain a license key for that particular measurement application. Enter the license key that you obtain into the N9020A Signal Analyzer to activate the new measurement application. See below for more information.

For the latest information on Agilent Signal Analyzer measurement applications and upgrade kits, visit the following internet URL.

http://www.agilent.com/find/sa_upgrades

Viewing a License Key

Measurement personalities purchased with your instrument have been installed and activated at the factory before shipment. The instrument requires a unique **License Key** for every measurement application purchased. The license key is a hexadecimal string that is specific to your measurement application, instrument model number and serial number. It enables you to install, or reactivate that particular application.

Press **System, Show, System** to display which measurement applications are currently licensed in your analyzer.

Go to the following location to view the license keys for the installed measurement applications:

C:\Programing Files\Agilent\Licensing

NOTE	You may want to keep a copy of your license key in a secure location. You can print out a copy of the display showing the license numbers to do this. If you should lose your license key, call your nearest Agilent Technologies service or sales office for assistance.
-------------	---

Obtaining and Installing a License Key

If you purchase an additional application that requires installation, you will receive an “Entitlement Certificate” which may be redeemed for a license key for one instrument. Follow the instructions that accompany the certificate to obtain your license key.

Installing a license key for the selected application can be done automatically using a USB memory device. To do this, you would put the license file on the USB memory device at the root level. Follow the instructions that come with your software installation kit.

Installing a license key can also be done manually using the license management application in the instrument. It is found through the instrument front panel keys at **System, Licensing. . .**, or internally at C:\Programming Files\Agilent\Licensing.

NOTE You can also use these procedures to reinstall a license key that has been accidentally deleted, or lost due to a memory failure.

Missing and Old Measurement Application Software

All the software applications were loaded at the time of original instrument manufacture. It is a good idea to regularly update your software with the latest available version. This assures that you get any improvements and expanded functionality that is available.

Because the software was loaded at the initial purchase, there may be additional measurement applications that are now available. If the application you are interested in licensing is not available, you will need to do a software update. (Press **System, Show, System.**)

Check the Agilent internet website for the latest software versions available for downloading:

http://www.agilent.com/find/mxa_software
http://www.agilent.com/find/exa_software

You must load the updated software package into the analyzer from a USB drive, or directly from the internet. An automatic loading program is included with the files.

X-Series Options and Accessories

[“MXA Instrument Options” on page 119](#)

[“MXA Accessories” on page 120](#)

[“EXA Instrument Options” on page 120](#)

[“EXA Accessories” on page 121](#)

[“Advanced Measurement Application Software” on page 121](#)

MXA Instrument Options

Product	Description
N9020A	MXA Signal Analyzer
N9020A-503	Frequency range from 20 Hz to 3.6 GHz
N9020A-508	Frequency range from 20 Hz to 8.4 GHz
N9020A-513	Frequency range from 20 Hz to 13.6 GHz
N9020A-526	Frequency range from 20 Hz to 26.5 GHz
N9020A-B25	Analysis bandwidth, 25 MHz
N9020A-BBA	Analog baseband IQ inputs
N9020A-PFR	Precision frequency reference
N9020A-PRC	Portable configuration

About the Analyzer
Installing Application Software

Product	Description
N9020A-EA3	Electric attenuator, 3.6 GHz
N9020A-S40	Baseband analysis bandwidth, 40 MHz/channel
N9020A-P03	Preamplifier, 3.6 GHz
N9020A-P08	Preamplifier, 8.4 GHz
N9020A-P13	Preamplifier, 13.6 GHz
N9020A-P26	Preamplifier, 26.5 GHz

MXA Accessories

Product	Description
N9020A-MLP	75 ohm minimum loss pad
N9020A-EFM	USB flash drive
N9020A-DVR	DVD-ROM drive
N9020A-MSE	Mouse, USB interface
N9020A-KYB	Keyboard, USB interface
N9020A-HTC	Hard transit case
N9020A-1CP	Rackmount kit with handles
N9020A-1CN	Front handle kit
N9020A-1CM	Rackmount kit
N9020A-1CR	Rack slide kit
N9020A-CPU	Instrument security, additional CPU and HDD
N9020A-UK6	Commercial Calibration Certificate with Test Data
N9020A-1A7	ISO 17025 Compliant Calibration
N9020A-A6J	ANSI Z540 Compliant Calibration

EXA Instrument Options

Product	Description
N9010A	EXA Signal Analyzer (3.6, 7.0, 13.6, and 26.5 GHz)
N9010A-503	Frequency range from 9 kHz to 3.6 GHz
N9010A-507	Frequency range from 9 kHz to 7.0 GHz
N9010A-513	Frequency range from 9 kHz to 13.6 GHz
N9010A-526	Frequency range from 9 kHz to 26.5 GHz

Product	Description
N9010A-FSA	Fine step attenuator
N9010A-PFR	Precision frequency reference
N9010A-PRC	Portable configuration
N9010A-EA3	Electric attenuator, 3.6 GHz
N9010A-P03	Preamplifier, 3.6 GHz

EXA Accessories

Product	Description
N9010A-MLP	Minimum loss pad, 50 to 75 ohms
N9010A-EFM	USB flash drive
N9010A-DVR	DVD-ROM/CD-R/RW drive
N9010A-MSE	Mouse, USB interface
N9010A-KYB	Keyboard, USB interface
N9010A-HTC	Hard transit case
N9010A-1CP	Rackmount kit with handles
N9010A-1CN	Front handle kit
N9010A-1CM	Rackmount kit
N9010A-1CR	Rack slide kit
N9010A-CPU	Instrument security, additional CPU and HDD
N9010A-UK6	Commercial Calibration Certificate with Test Data
N9010A-1A7	ISO 17025 Compliant Calibration
N9010A-A6J	ANSI Z540 Compliant Calibration

Advanced Measurement Application Software

For a current list of application software, go to the following URLs.

For MXA,

<http://www.agilent.com/find/mxa/options>

Select the *MXA N9020A, Options and Measurement Applications* link on the top of the page.

For EXA,

<http://www.agilent.com/find/exa/options>

Select the *EXA N9010A, Options and Measurement Applications* link on the top of the page.

Front-Panel Features

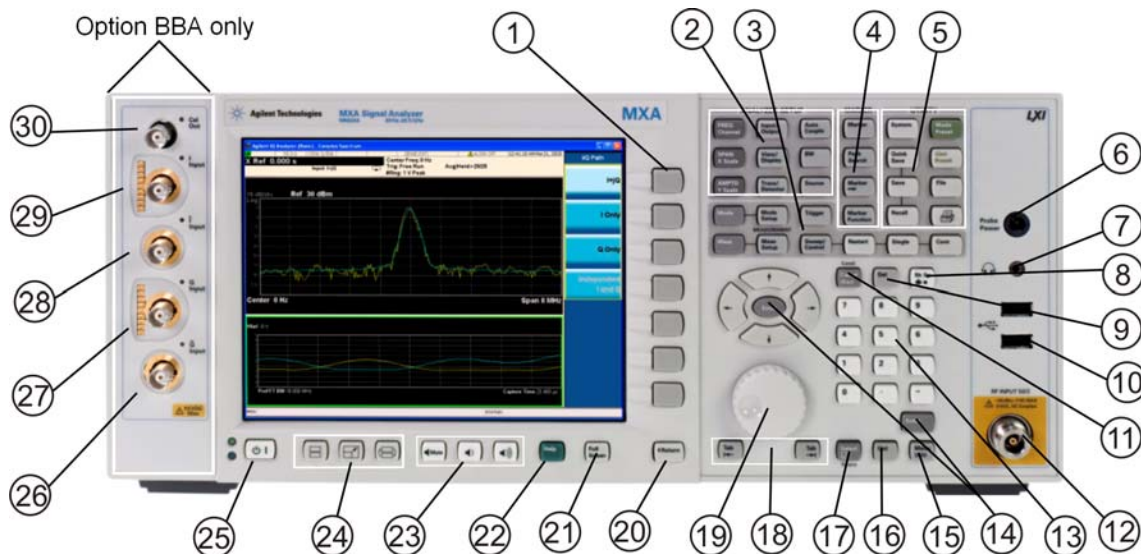

Item		Description
#	Name	
1	Menu Keys	Key labels appear to the left of the menu keys to identify the current function of each key. The displayed functions are dependent on the currently selected Mode and Measurement, and are directly related to the most recent key press.
2	Analyzer Setup Keys	These keys set the parameters used for making measurements in the current Mode and Measurement.
3	Measurement Keys	These keys select the Mode, and the Measurement within the mode. They also control the initiation and rate of recurrence of measurements.
4	Marker Keys	Markers are often available for a measurement, to measure a very specific point/segment of data within the range of the current measurement data.
5	Utility Keys	These keys control system-wide functionality such as: <ul style="list-style-type: none"> • instrument configuration information and I/O setup, • printer setup and printing, • file management, save and recall, • instrument presets.
6	Probe Power	Supplies power for external high frequency probes and accessories.
7	Headphones Output	Headphones can be used to hear any available audio output.
8	Back Space Key	Press this key to delete the previous character when entering alphanumeric information. It also works as the Back key in Help and Explorer windows.

Item		Description
#	Name	
9	Delete Key	Press this key to delete files, or to perform other deletion tasks.
10	USB Connectors	Standard USB 2.0 ports, Type A. Connect to external peripherals such as a mouse, keyboard, DVD drive, or hard drive.
11	Local/Cancel/(Esc) Key	<p>If you are in remote operation, Local:</p> <ul style="list-style-type: none"> • returns instrument control from remote back to local (the front panel). • turns the display on (if it was turned off for remote operation). • can be used to clear errors. (Press the key once to return to local control, and a second time to clear error message line.) <p>If you have not already pressed the units or Enter key, Cancel exits the currently selected function without changing its value.</p> <p>Esc works the same as it does on a pc keyboard. It:</p> <ul style="list-style-type: none"> • exits Windows dialogs • clears errors • aborts printing • cancels operations.
12	RF Input	Connector for inputting an external signal. Make sure that the total power of all signals at the analyzer input does <i>not</i> exceed +30 dBm (1 watt).
13	Numeric Keypad	Enters a specific numeric value for the current function. Entries appear on the upper left of the display, in the measurement information area.
14	Enter and Arrow Keys	<p>The Enter key terminates data entry when either no unit of measure is needed, or you want to use the default unit.</p> <p>The arrow keys:</p> <ul style="list-style-type: none"> • Increment and decrement the value of the current measurement selection. • Navigate help topics. • Navigate, or make selections, within Windows dialogs. • Navigate within forms used for setting up measurements. • Navigate within tables. <p>NOTE The arrow keys cannot be used to move a mouse pointer around on the display.</p>
15	Menu/ (Alt) Key	Alt works the same as a pc keyboard. Use it to change control focus in Windows pull-down menus.
16	Ctrl Key	Ctrl works the same as a pc keyboard. Use it to navigate in Windows applications, or to select multiple items in lists.
17	Select / Space Key	Select is also the Space key and it has typical pc functionality. For example, in Windows dialogs, it selects files, checks and unchecks check boxes, and picks radio button choices. It opens a highlighted Help topic.
18	Tab Keys	Use these keys to move between fields in Windows dialogs.
19	Knob	Increments and decrements the value of the current active function.
20	Return Key	Exits the current menu and returns to the previous menu. Has typical pc functionality.

About the Analyzer
Front-Panel Features

Item		Description
#	Name	
21	Full Screen Key	Pressing this key turns off the softkeys to maximize the graticule display area. Press the key again to restore the normal display.
22	Help Key	Initiates a context-sensitive Help display for the current Mode. Once Help is accessed, pressing a front panel key brings up the help topic for that key function.
23	Speaker Control Keys	Enables you to increase or decrease the speaker volume, or mute it.
24	Window Control Keys	These keys select between single or multiple window displays. They zoom the current window to fill the data display, or change the currently selected window. They can be used to switch between the Help window navigation pane and the topic pane.
25	Power Standby/ On	<p>Turns the analyzer on. A green light indicates power on. A yellow light indicates standby mode.</p> <p>NOTE The front-panel switch is a standby switch, <i>not</i> a LINE switch (disconnecting device). The analyzer continues to draw power even when the line switch is in standby.</p> <p>The main power cord can be used as the system disconnecting device. It disconnects the mains circuits from the mains supply.</p>
26	\bar{Q} Input	Input port for the Q channel when in differential mode.*
27	Q Input	Input port for the Q channel for either single or differential mode.*
28	\bar{I} Input	Input port for the I channel when in differential mode.*
29	I Input	Input port for the I channel for either single or differential mode.*
30	Cal Out	Output port for calibrating the I, \bar{I} , Q and \bar{Q} inputs and probes used with these inputs.*

*. Status of the LED indicates whether the current state of the port is active (green) or is not in use (dark).

Overview of key types

The keys labeled **FREQ Channel**, **System**, and **Marker Functions** are all examples of front-panel keys. Most of the dark or light gray keys access menus of functions that are displayed along the right side of the display. These displayed key labels are next to a column of keys called menu keys.

Menu keys list functions based on which front-panel key was pressed last. These functions are also dependant on the current selection of measurement application (**Mode**) and measurement (**Meas**).

If the numeric value of a menu key function can be changed, it is called an active function. The function label of the active function is highlighted after that key has been selected. For example, press **AMPTD Y Scale**. This calls up the menu of related amplitude functions. The function labeled **Ref Level** (the default selected key in the Amplitude menu) is highlighted. **Ref Level** also appears in the upper left of the display in the measurement information area. The displayed value indicates that the function is selected and its value can now be changed using any of the data entry controls.

Some menu keys have multiple choices on their label, such as **On/Off** or **Auto/Man**. The different choices are selected by pressing the key multiple times. For example, the Auto/Man type of key. To select the function, press the menu key and notice that Auto is underlined and the key becomes highlighted. To change the function to manual, press the key again so that Man is underlined. If there are more than two settings on the key, keep pressing it until the desired selection is underlined.

When a menu first appears, one key label is highlighted to show which key is the default selection. If you press **Marker Function**, the **Marker Function Off** key is the menu default key, and is highlighted.

Some of the menu keys are grouped together by a yellow bar running behind the keys near the left side or by a yellow border around the group of keys. When you press a key within the yellow region, such as **Marker Noise**, the highlight moves to that key to show it has been selected. The keys that are linked are related functions, and only one of them can be selected at any one time. For example, a marker can only have one marker function active on it. So if you select a different function it turns off the previous selection. If the current menu is two pages long, the yellow bar or border could include keys on the second page of keys.



In some key menus, a key label is highlighted to show which key has been selected from multiple available choices. And the menu is immediately exited when you press one of the other keys. For example, when you press the **Select Trace** key (in the **Trace/Detector** menu), it brings up its own menu of keys. The **Trace 1** key is highlighted. When you press the **Trace 2** key, the highlight moves to that key and the screen returns to the **Trace/Detector** menu.

If a displayed key label shows a small solid-black arrow tip pointing to the right, it indicates that additional key menus are available. If the arrow tip is not filled in solid then pressing the key the first time selects that function. Now the arrow is solid and pressing it again brings up an additional menu of settings.

Display Annotations

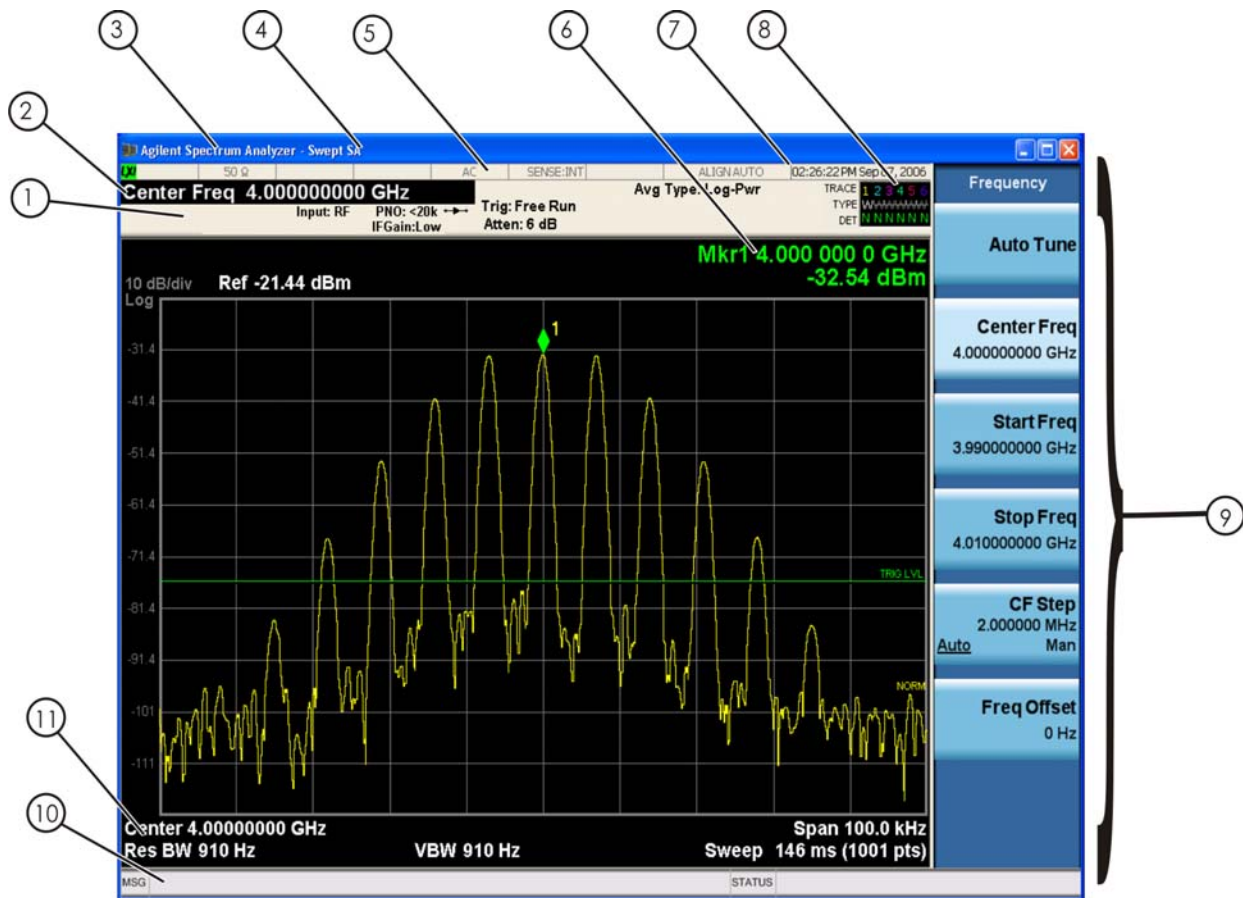
This section describes the display annotation as it is on the Spectrum Analyzer Measurement Application display. Other measurement application modes have some annotation differences.



Item	Description	Function Keys
1	Measurement bar - Shows general measurement settings and information.   Indicates single/continuous measurement. Some measurements include limits that the data is tested against. A Pass/Fail indication may be shown in the lower left of the measurement bar.	All the keys in the Analyzer Setup part of the front panel.
2	Active Function (measurement bar) - when the current active function has a settable numeric value, it is shown here.	Currently selected front panel key.
3	Banner - shows the name of the selected application that is currently running.	Mode
4	Measurement title - shows title information for the current measurement, or a title that you created for the measurement.	Meas View/Display, Display, Title

Item	Description	Function Keys
5	Settings panel - displays system information that is not specific to any one application. <ul style="list-style-type: none"> • Input/Output status - green LXI indicates the LAN is connected. RLTS indicate Remote, Listen, Talk, SRQ • Input impedance and coupling • Selection of external frequency reference • Setting of automatic internal alignment routine 	Local and System, I/O Config Input/Output, Amplitude, System and others
6	Active marker frequency, amplitude or function value	Marker
7	Settings panel - time and date display.	System, Control Panel
8	Trace and detector information	Trace/Detector, Clear Write (W) Trace Average (A) Max Hold (M) Min Hold (m) Trace/Detector, More, Detector, Average (A) Normal (N) Peak (P) Sample (S) Negative Peak (p)
9	Key labels that change based on the most recent key press.	Softkeys
10	Displays information, warning and error messages. Message area - single events, Status area - conditions	
11	Measurement settings for the data currently being displayed in the graticule area. In the example above: center frequency, resolution bandwidth, video bandwidth, frequency span, sweep time and number of sweep points.	Keys in the Analyzer Setup part of the front panel.

Rear-Panel Features

MXA and EXA with Option PC2

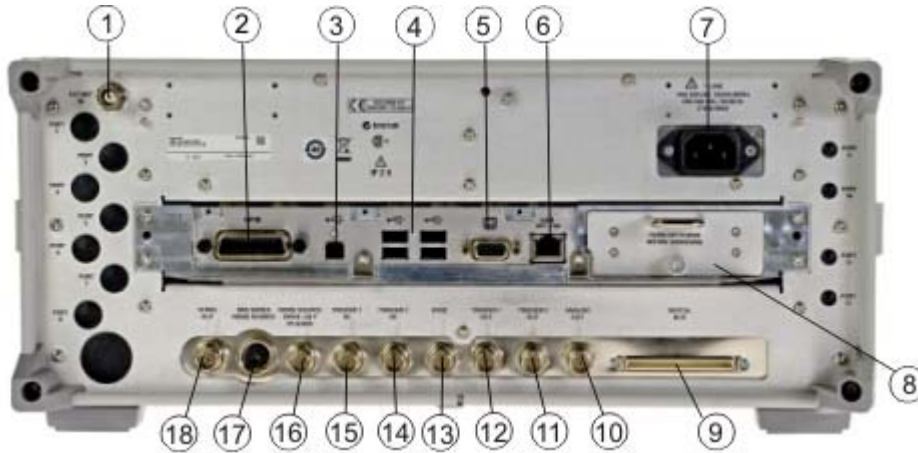

EXA



Item		Description
#	Name	
1	EXT REF IN	Input for an external frequency reference signal: For MXA – 1 to 50 MHz For EXA – 10 MHz.
2	GPIB	A General Purpose Interface Bus (GPIB, IEEE 488.1) connection that can be used for remote analyzer operation.

Item		Description
#	Name	
3	USB Connector	USB 2.0 port, Type B. USB TMC (test and measurement class) connects to an external pc controller to control the instrument and for data transfers over a 480 Mbps link.
4	USB Connectors	Standard USB 2.0 ports, Type A. Connect to external peripherals such as a mouse, keyboard, printer, DVD drive, or hard drive.
5	MONITOR	Allows connection of an external VGA monitor.
6	LAN	A TCP/IP Interface that is used for remote analyzer operation.
7	Line power input	The AC power connection. See the product specifications for more details.
8	Removable Disk Drive	Standard on MXA. Optional on EXA.
9	Digital Bus	Reserved for future use.
10	Analog Out	Reserved for future use.
11	TRIGGER 2 OUT	A trigger output used to synchronize other test equipment with the analyzer. Configurable from the Input/Output keys.
12	TRIGGER 1 OUT	A trigger output used to synchronize other test equipment with the analyzer. Configurable from the Input/Output keys.
13	Sync	Reserved for future use.
14	TRIGGER 2 IN	Allows external triggering of measurements.
15	TRIGGER 1 IN	Allows external triggering of measurements.
16	Noise Source Drive +28 V (Pulsed)	For use with Agilent 346A, 346B, and 346C Noise Sources
17	SNS Series Noise Source	For use with Agilent N4000A, N4001A, N4002A Smart Noise Sources (SNS).
18	10 MHz OUT	An output of the analyzer internal 10 MHz frequency reference signal. It is used to lock the frequency reference of other test equipment to the analyzer.

Window Control Keys

The instrument provides three front-panel keys for controlling windows. They are **Multi Window**, **Zoom**, and **Next Window**. These are all “immediate action” keys.

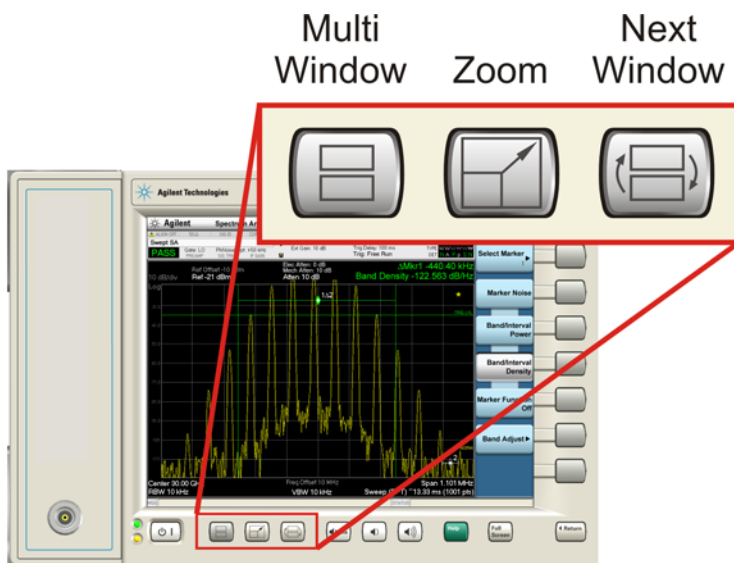

Multi-Window

The **Multi Window** front-panel key is not used at this time. It is there to support future functionality.

Key Path	Front-panel key
Help Map ID	3496
Instrument S/W Revision	Prior to A.02.00

Zoom

Zoom is a toggle function. Pressing once Zooms the selected window; pressing again un-zooms.

When Zoom is on for a window, that window will get the entire primary display area. The zoomed window, since it is the selected window, is outlined in green.

Zoom is local to each Measurement. Each Measurement remembers its Zoom state. The Zoom state of each Measurement is part of the Mode's state.

NOTE Data acquisition and processing for the other windows continues while a window is zoomed, as does all SCPI communication with the other windows.

Remote Command:	:DISPlay:WINDow:FORMat:ZOOM
Remote Command:	:DISPlay:WINDow:FORMat:TILE
Example:	:DISP:WIND:FORM:ZOOM sets zoomed :DISP:WIND:FORM:TILE sets un-zoomed
Preset:	TILE
Help Map ID:	3497
Instrument S/W Revision:	Prior to A.02.00

Next Window

This key selects the next window of the current view.

When this key is selected in Help Mode, it toggles focus between the table of contents window and the topic pane window.

Remote Command:	:DISPlay:WINDow[:SElect] <number> :DISPlay:WINDow[:SElect]?
Example:	:DISP:WIND 1
Preset:	1
Min:	1
Max:	If <number> is greater than the number of windows, limit to <number of windows>
Help Map ID:	0
Instrument S/W Revision:	Prior to A.02.00

Selected Window

One and only one window is always selected. The selected window has the focus; as far as you are concerned, all key presses are going to that window.

If a window is not selected, its boundary is gray. The selected window has a green boundary.

If a window in a multi-window display is zoomed it is still outlined in green. If there is only one window, the green outline is not used. This allows you to distinguish between a zoomed window and a display with only one window.

The selected window is local to each Measurement. Each Measurement remembers which window is selected. The selected window for each Measurement is remembered in Mode state.

Navigating Windows

When the Next Window key is pressed, the next window in the order of precedence (see below) becomes

About the Analyzer
Window Control Keys

selected. If the selected window was zoomed, the next window will also be zoomed.

The window navigation does NOT use the arrow and select keys. Those are reserved for navigation within a window.

About the Analyzer Mouse and Keyboard Control

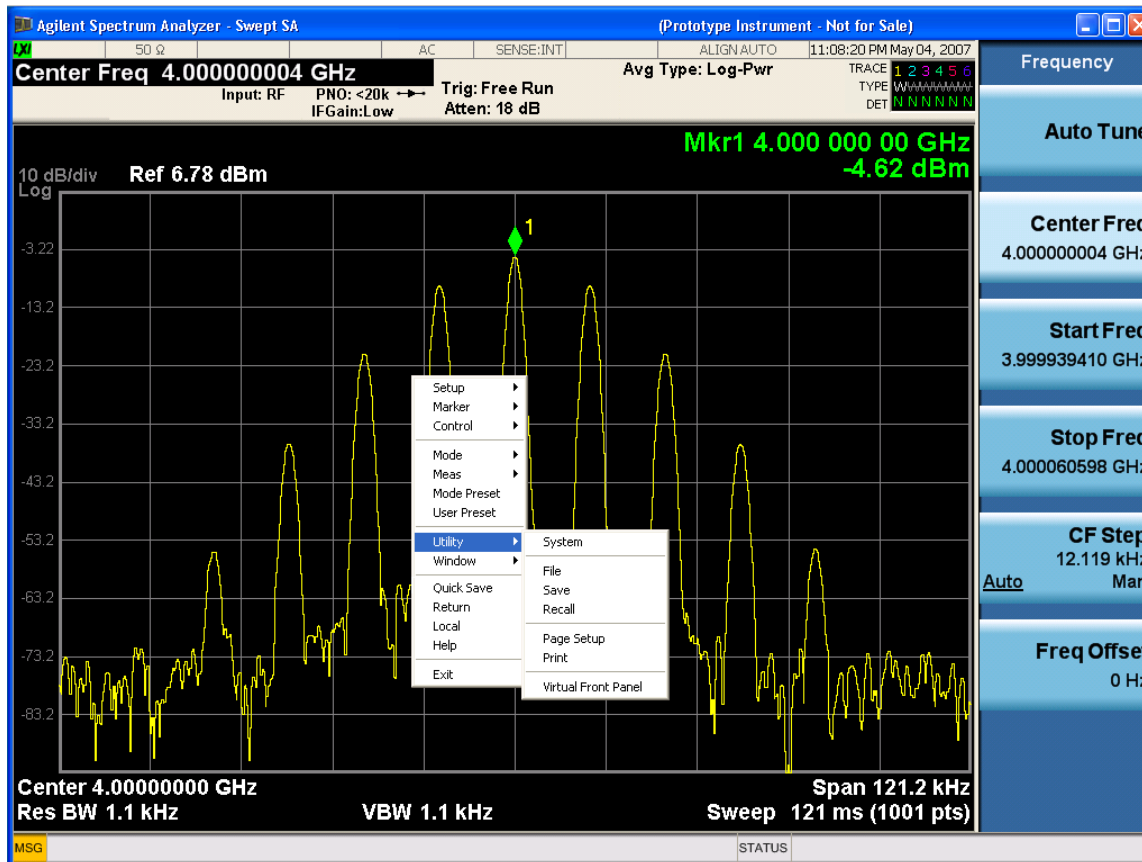

This method can be used to access any of the front-panel keys by using a mouse; as for example if you are accessing the instrument through Remote Desktop.

The array of keys thus available is shown below :

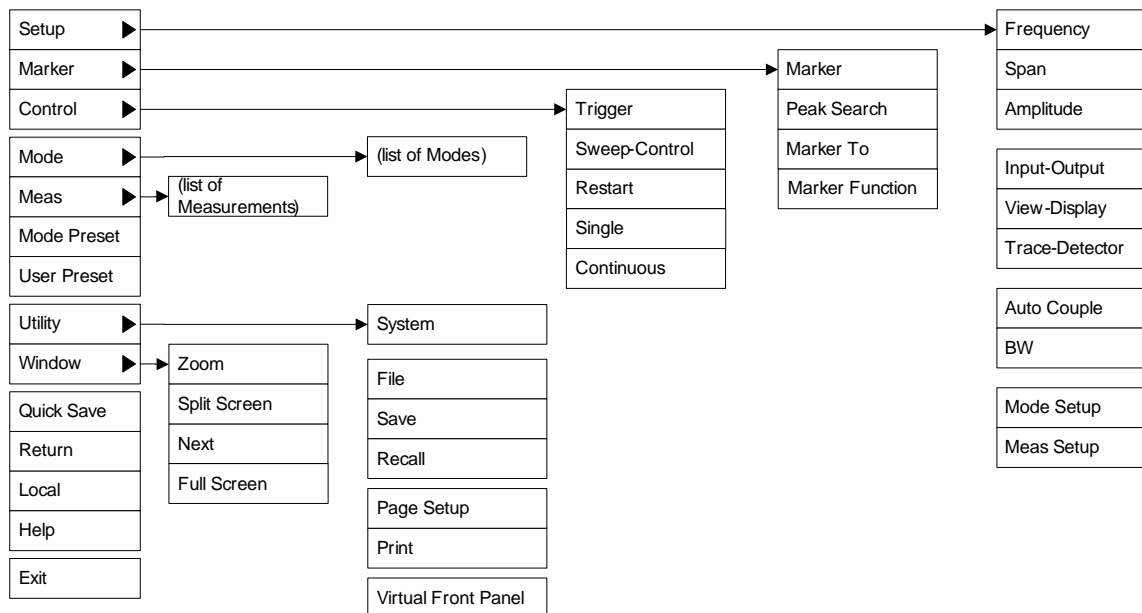

PC Keyboard

If you have a PC keyboard plugged in (or via Remote Desktop), certain key codes on the PC keyboard map to front-panel keys on the GPSA front panel. These key codes are shown below:

Frequency	CTRL+SHIFT+F
Span	CTRL+SHIFT+S
Amplitude	CTRL+SHIFT+A
Input/Output	CTRL+SHIFT+O
View/Display	CTRL+SHIFT+V
Trace/Detector	CTRL+ALT+T
Auto Couple	CTRL+SHIFT+C
Bandwidth	CTRL+ALT+B
Source	CTRL+SHIFT+E
Marker	CTRL+SHIFT+K
Peak Search	CTRL+SHIFT+P
Marker To	CTRL+ALT+N
Marker Function	CTRL+ALT+F
System	CTRL+SHIFT+Y
Quick Save	CTRL+SHIFT+Q
Save	CTRL+S
Recall	CTRL+R
Mode Preset	CTRL+M
User Preset	CTRL+U
Print	CTRL+P
File	CTRL+SHIFT+L
Mode	CTRL+SHIFT+M
Measure	CTRL+ALT+M
Mode Setup	CTRL+ALT+E
Meas Setup	CTRL+ALT+U
Trigger	CTRL+SHIFT+T
Sweep/Control	CTRL+SHIFT+W
Restart	CTRL+ALT+R
Single	CTRL+ALT+S

About the Analyzer
Mouse and Keyboard Control

Cont	CTRL+ALT+C
Zoom	CTRL+SHIFT+Z
Next Window	CTRL+SHIFT+N
Split Screen	CTRL+L
Full Screen	CTRL+SHIFT+B
Return	CTRL+SHIFT+R
Mute	Mute
Inc Audio	Volume Up
Dec Audio	Volume Down
Help	F1
Control	CTRL
Alt	ALT
Enter	Return
Cancel	Esc
Del	Delete
Backspace	Backspace
Select	Space
Up Arrow	Up
Down Arrow	Down
Left Arrow	Left
Right Arrow	Right
Menu key 1	CTRL+SHIFT+F1
Menu key 2	CTRL+SHIFT+F2
Menu key 3	CTRL+SHIFT+F3
Menu key 4	CTRL+SHIFT+F4
Menu key 5	CTRL+SHIFT+F5
Menu key 6	CTRL+SHIFT+F6
Menu key 7	CTRL+SHIFT+F7
Backspace	BACKSPACE
Enter	ENTER
Tab	Tab
1	1

2	2
3	3
4	4
5	5
6	6
7	7
8	8
9	9
0	0

Here is a pictorial view of the table above:

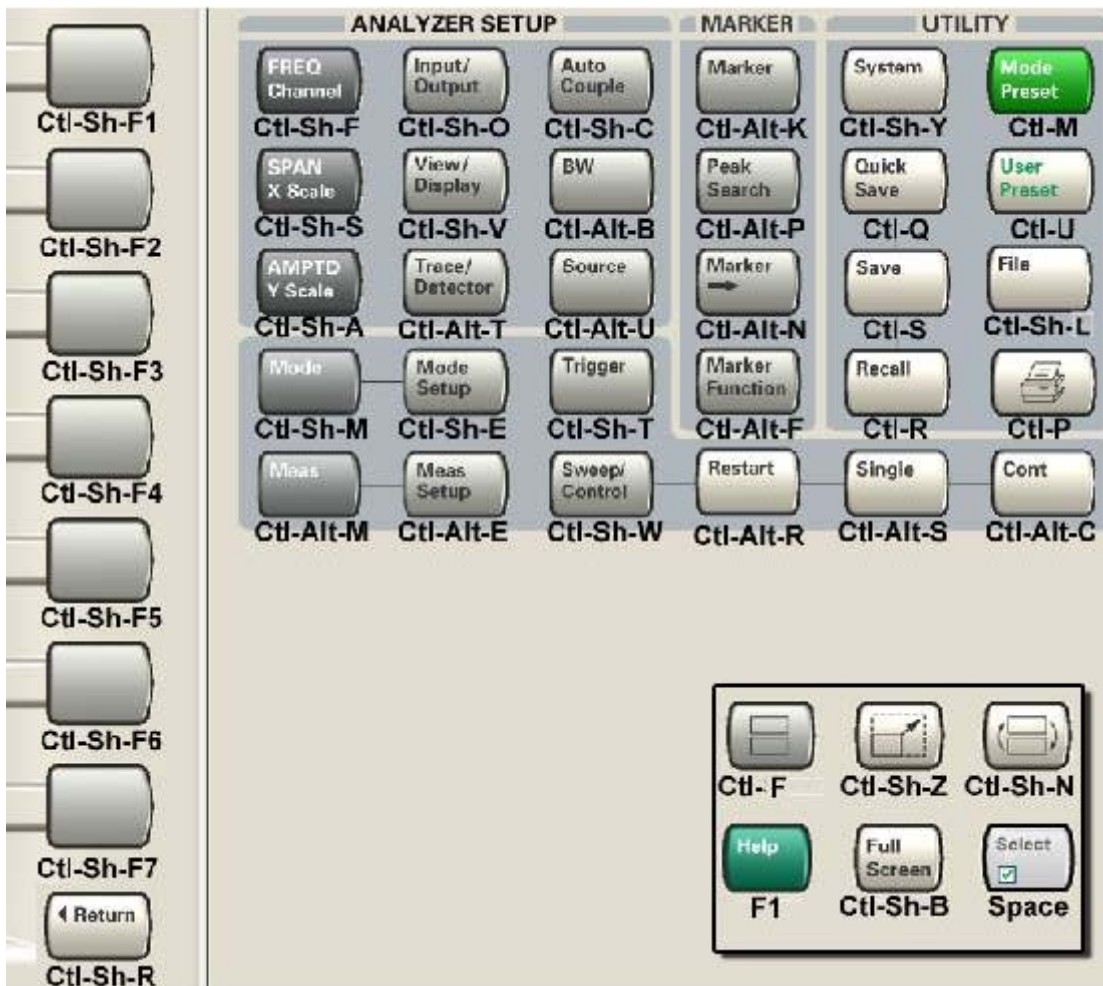

About the Analyzer
Mouse and Keyboard Control

About TD-SCDMA with HSPA/8PSK Measurement Application

This chapter provides information on using the TD-SCDMA with HSPA/8PSK Mode in your Agilent Signal Analyzer.

What Does TD-SCDMA with HSPA/8PSK Mode Do?

This mode provides the following measurements of TD-SCDMA (3GPP) and HSPA/8PSK signals:

- Transmit Power
- Adjacent Channel Power (ACP)
- Power vs Time
- Spectrum Emission Mask (SEP)
- Spurious Emissions
- Occupied BW
- Power Stat CCDF
- Code Domain
- Modulation Accuracy (Composite EVM)
- IQ Waveform
- Monitor Spectrum

The analyzer automatically makes these measurements using the measurement methods and limits defined in the TD-SCDMA (3GPP) standard specifications. The detailed results displayed by the measurements enable you to analyze TD-SCDMA system performance. You may alter the measurement parameters for specialized analysis.

Baseband I/Q Input Hardware Option BBA (Optional)

Baseband I/Q Input (BBIQ) functionality is available in the TD-SCDMA with HSPA/8PSK Mode and provides the ability to analyze Baseband I/Q signal characteristics of mobile and base station transmitters.

The following measurements are available for use with the Baseband I/Q Input:

- Transmit Power
- Power Stat CCDF
- Code Domain
- Modulation Accuracy (Composite EVM)
- IQ Waveform

Installing Application Software

When you want to install a measurement application after your initial hardware purchase, you actually only need to license it. All of the available applications are loaded in your analyzer at the time of purchase.

So when you purchase an application, you will receive an entitlement certificate that is used to obtain a license key for that particular measurement application. Enter the license key that you obtain into the N9020A Signal Analyzer to activate the new measurement application. See below for more information.

For the latest information on Agilent Signal Analyzer measurement applications and upgrade kits, visit the following internet URL.

http://www.agilent.com/find/sa_upgrades

Viewing a License Key

Measurement personalities purchased with your instrument have been installed and activated at the factory before shipment. The instrument requires a unique **License Key** for every measurement application purchased. The license key is a hexadecimal string that is specific to your measurement application, instrument model number and serial number. It enables you to install, or reactivate that particular application.

Press **System, Show, System** to display which measurement applications are currently licensed in your analyzer.

Go to the following location to view the license keys for the installed measurement applications:

C:\Programing Files\Agilent\Licensing

NOTE	You may want to keep a copy of your license key in a secure location. You can print out a copy of the display showing the license numbers to do this. If you should lose your license key, call your nearest Agilent Technologies service or sales office for assistance.
-------------	---

Obtaining and Installing a License Key

If you purchase an additional application that requires installation, you will receive an “Entitlement Certificate” which may be redeemed for a license key for one instrument. Follow the instructions that accompany the certificate to obtain your license key.

Installing a license key for the selected application can be done automatically using a USB memory device. To do this, you would put the license file on the USB memory device at the root level. Follow the instructions that come with your software installation kit.

Installing a license key can also be done manually using the license management application in the instrument. It is found through the instrument front panel keys at **System, Licensing. . .**, or internally at C:\Programming Files\Agilent\Licensing.

NOTE You can also use these procedures to reinstall a license key that has been accidentally deleted, or lost due to a memory failure.

Missing and Old Measurement Application Software

All the software applications were loaded at the time of original instrument manufacture. It is a good idea to regularly update your software with the latest available version. This assures that you get any improvements and expanded functionality that is available.

Because the software was loaded at the initial purchase, there may be additional measurement applications that are now available. If the application you are interested in licensing is not available, you will need to do a software update. (Press **System, Show, System.**)

Check the Agilent internet website for the latest software versions available for downloading:

http://www.agilent.com/find/mxa_software

http://www.agilent.com/find/exa_software

You must load the updated software package into the analyzer from a USB drive, or directly from the internet. An automatic loading program is included with the files.

This chapter provides introductory information about the programming documentation included with your product.

What Programming Information is Available?

The X-Series Documentation can be accessed through the Additional Documentation page in the instrument Help system and is included on the Documentation CD shipped with the instrument. It can also be found in the instrument at: C:\ProgramsFiles\Agilent\SignalAnalysis\Infrastructure\Help\otherdocs, or online at: http://www.agilent.com/find/mxa_manuals.

The following resources are available to help you create programs for automating your X-Series measurements:

Resource	Description
X-Series Programmer's Guide	<p>Provides general SCPI programming information on the following topics:</p> <ul style="list-style-type: none">• Programming the X-Series Applications• Programming fundamentals• Programming examples <p>Note that SCPI command descriptions for measurement applications are NOT in this book, but are in the User's and Programmer's Reference.</p>
User's and Programmer's Reference manuals	<p>Describes all front-panel keys and softkeys, including SCPI commands for a measurement application. Note that:</p> <ul style="list-style-type: none">• Each measurement application has its own User's and Programmer's Reference.• The content in this manual is duplicated in the analyzer's Help (the Help that you see for a key is identical to what you see in this manual).
Embedded Help in your instrument	<p>Describes all front-panel keys and softkeys, including SCPI commands, for a measurement application.</p> <p>Note that the content that you see in Help when you press a key is identical to what you see in the User's and Programmer's Reference.</p>
X-Series Getting Started Guide	<p>Provides valuable sections related to programming including:</p> <ul style="list-style-type: none">• Licensing New Measurement Application Software - After Initial Purchase• Configuring instrument LAN Hostname, IP Address, and Gateway Address• Using the Windows XP Remote Desktop to connect to the instrument remotely• Using the Embedded Web Server Telnet connection to communicate SCPI <p>This printed document is shipped with the instrument.</p>
Agilent Application Notes	<p>Printable PDF versions of pertinent application notes.</p>
Agilent VISA User's Guide	<p>Describes the Agilent Virtual Instrument Software Architecture (VISA) library and shows how to use it to develop I/O applications and instrument drivers on Windows PCs.</p>

STATus Subsystem (No equivalent front-panel keys)

The following graphics show the current X-Series Status Register Subsystem implementation.

X-Series Status Byte Register System

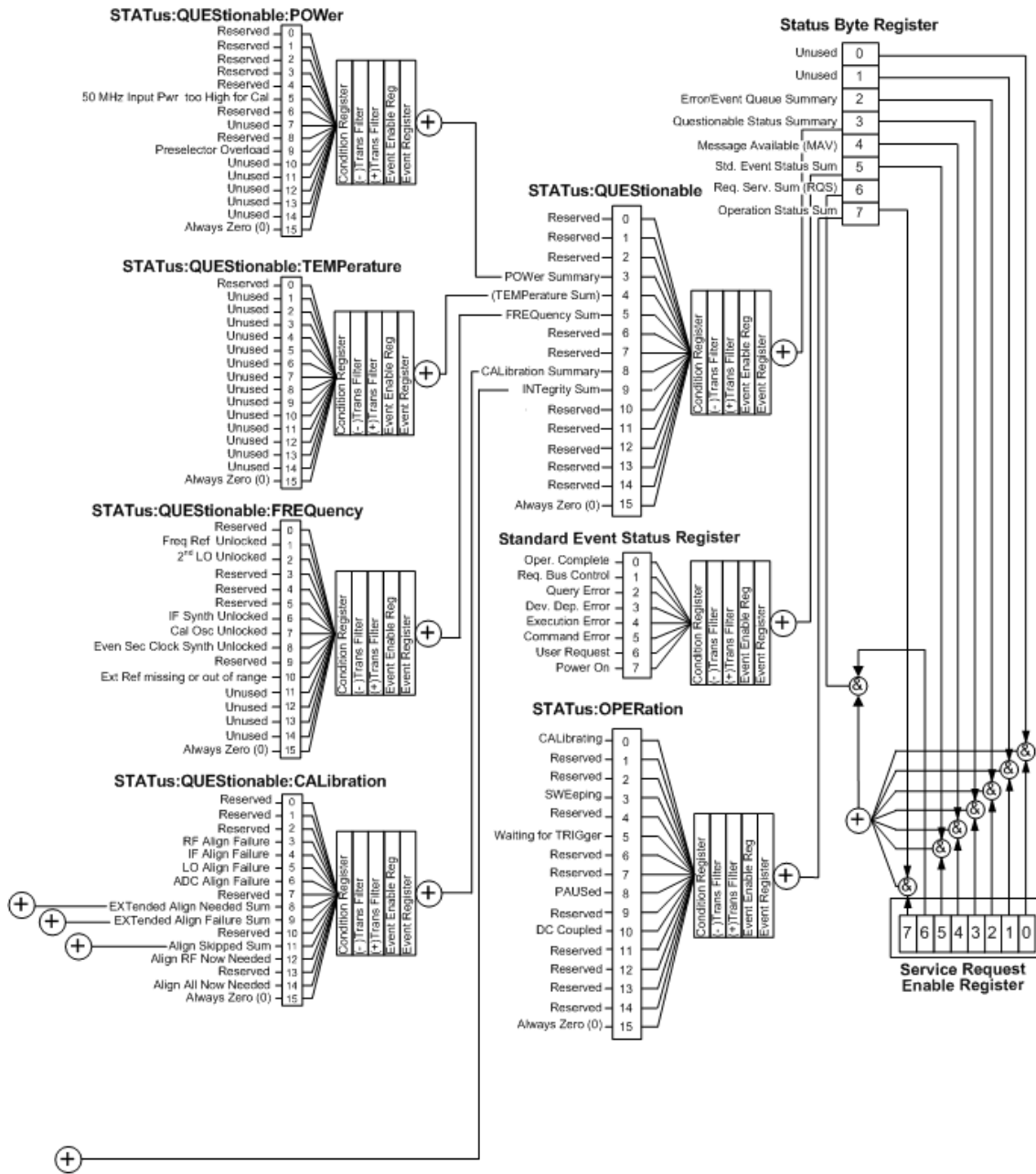

Additional Registers:

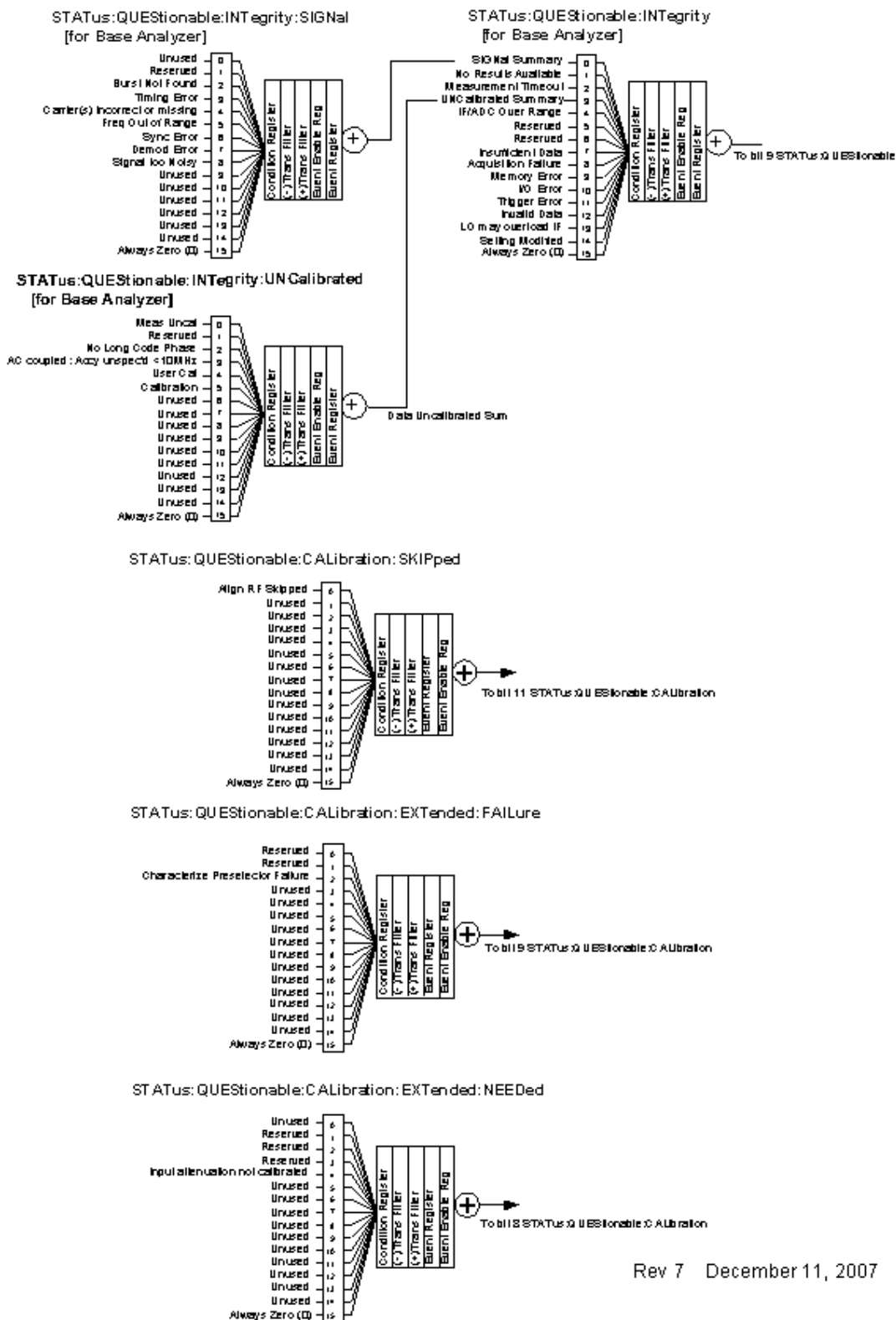

Rev 7 December 11, 2007

Detailed Description

The STATus subsystem remote commands set and query the status hardware registers. This system of registers monitors various events and conditions in the instrument. Software written to control the instrument may need to monitor some of these events and conditions.

All status register commands are sequential. Most commands can be started immediately and will overlap with any existing commands that are already running. This is not true of status commands. All the commands in the spectrum analyzer are assumed to be overlapped unless a command description specifically says that it is sequential.

What Are Status Registers

The status system contains multiple registers that are arranged in a hierarchical order. The lower-level status registers propagate their data to the higher-level registers in the data structures by means of summary bits. The status byte register is at the top of the hierarchy and contains general status information for the instrument's events and conditions. All other individual registers are used to determine the specific events or conditions. For a diagram of the registers and their interconnections, see above.

The operation and questionable status registers are sets of registers that monitor the overall instrument condition. They are accessed with the STATus:OPERation and STATus:QUEStionable commands in the STATus command subsystem. Each register set is made up of five registers:

- Condition Register – It reports the real-time state of the signals monitored by this register set. There is no latching or buffering for a condition register.
- Positive Transition Register – This filter register controls which signals will set a bit in the event register when the signal makes a low to high transition (when the condition bit changes from 0 to 1).
- Negative Transition Register – This filter register controls which signals will set a bit in the event register when the signal makes a high to low transition (when the condition bit changes from 1 to 0).
- Event Register – It latches any signal state changes, in the way specified by the filter registers. Bits in the event register are never cleared by signal state changes. Event registers are cleared when read. They are also cleared by *CLS and by presetting the instrument.
- Event Enable Register – It controls which of the bits, being set in the event register, will be summarized as a single output for the register set. Summary bits are then used by the next higher register.

The STATus:QUEStionable registers report abnormal operating conditions. The status register hierarchy is:

1. The summary outputs from the six STATus:QUEStionable:<keyword> detail registers are inputs to the STATus:QUEStionable register.
2. The summary output from the STATus:QUEStionable register is an input to the Status Byte Register. See the overall system in Figure at the beginning of this section.

The STATus:OPERation register set has no summarized inputs. The inputs to the STATus:OPERation:CONDition register indicate the real time state of the instrument. The STATus:OPERation:EVENt register summary output is an input to the Status Byte Register.

What Are Status Register SCPI Commands

Most monitoring of the instrument conditions is done at the highest level using the IEEE common commands indicated below. Complete command descriptions are available in the IEEE commands section at the beginning of the language reference. Individual status registers can be set and queried using the commands in the STATus subsystem of the language reference.

- *CLS (clear status) clears the status byte by emptying the error queue and clearing all the event registers.
- *ESE, *ESE? (event status enable) sets and queries the bits in the enable register part of the standard event status register.
- *ESR? (event status register) queries and clears the event register part of the standard event status register.
- *OPC, *OPC? (operation complete) sets the standard event status register to monitor the completion of all commands. The query stops any new commands from being processed until the current processing is complete, then returns a '1'.
- *PSC, *PSC? (power-on state clear) sets the power-on state so that it clears the service request enable register and the event status enable register at power on.
- *SRE, *SRE? (service request enable) sets and queries the value of the service request enable register.
- *STB? (status byte) queries the value of the status byte register without erasing its contents.

How to Use the Status Registers

A program often needs to be able to detect and manage error conditions or changes in instrument status. There are two methods you can use to programmatically access the information in status registers:

- The polling method
- The service request (SRQ) method

In the polling method, the instrument has a passive role. It only tells the controller that conditions have changed when the controller asks the right question. In the SRQ method, the instrument takes a more active role. It tells the controller when there has been a condition change without the controller asking. Either method allows you to monitor one or more conditions.

The polling method works well if you do not need to know about changes the moment they occur. The SRQ method should be used if you must know immediately when a condition changes. To detect a change using the polling method, the program must repeatedly read the registers.

Use the SRQ method when:

- you need time-critical notification of changes
- you are monitoring more than one device which supports SRQs
- you need to have the controller do something else while waiting
- you can't afford the performance penalty inherent to polling

Use polling when:

- your programming language/development environment does not support SRQ interrupts
- you want to write a simple, single-purpose program and don't want the added complexity of setting up an SRQ handler
- To monitor a condition:
 1. Determine which register contains the bit that reports the condition.
 2. Send the unique SCPI query that reads that register.
 3. Examine the bit to see if the condition has changed.

You can monitor conditions in different ways.

- Check the current instrument hardware and firmware status.

Do this by querying the condition registers which continuously monitor status. These registers represent the current state of the instrument. Bits in a condition register are updated in real time. When the condition monitored by a particular bit becomes true, the bit is set to 1. When the condition becomes false, the bit is reset to 0.

- Monitor a particular condition (bit).

You can enable a particular bit(s), using the event enable register. The instrument will then monitor that particular condition(s). If the bit becomes true (0 to 1 transition) in the event register, it will stay set until the event register is cleared. Querying the event register allows you to detect that this condition occurred even if the condition no longer exists. The event register can only be cleared by querying it or sending the *CLS command.

- Monitor a particular type of change in a condition (bit).
 - The transition registers are preset to register if the condition goes from 0 to 1 (false to true, or a positive transition).
 - This can be changed so the selected condition is detected if the bit goes from 1 to 0 (true to false, or a negative transition).
 - It can also be set for both types of transitions occurring.
 - Or it can be set for neither transition. If both transition registers are set to 0 for a particular bit position, that bit will not be set in the event register for either type of change.

Using a Status Register

Each bit in a register is represented by a numerical value based on its location. See figure below. This number is sent with the command to enable a particular bit. If you want to enable more than one bit, you would send the sum of all the bits that you want to monitor.

Figure: Status Register Bit Values

method, you must:

1. Determine which bit monitors the condition.
2. Determine how that bit reports to the request service (RQS) bit of the status byte.
3. Send SCPI commands to enable the bit that monitors the condition and to enable the summary bits that report the condition to the RQS bit.
4. Enable the controller to respond to service requests.

When the condition changes, the instrument sets its RQS bit. The controller is informed of the change as soon as it occurs. As a result, the time the controller would otherwise have used to monitor the condition can be used to perform other tasks. Your program determines how the controller responds to the SRQ.

Generating a Service Request To use the SRQ method, you must understand how service requests are generated. Bit 6 of the status byte register is the request service (RQS) bit. The *SRE command is used to configure the RQS bit to report changes in instrument status. When such a change occurs, the RQS bit is set. It is cleared when the status byte register is queried using *SRE? (with a serial poll.) It can be queried without erasing the contents with *STB?.

When a register set causes a summary bit in the status byte to change from 0 to 1, the instrument can initiate the service request (SRQ) process. However, the process is only initiated if both of the following conditions are true:

- The corresponding bit of the service request enable register is also set to 1.
- The instrument does not have a service request pending. (A service request is considered to be pending between the time the instrument's SRQ process is initiated and the time the controller reads the status byte register.)

The SRQ process sets the SRQ true. It also sets the status byte's request service (RQS) bit to 1. Both actions are necessary to inform the controller that the instrument requires service. Setting the SRQ line only informs the controller that some device on the bus requires service. Setting the RQS bit allows the controller to determine which instrument requires service.

If your program enables the controller to detect and respond to service requests, it should instruct the controller to perform a serial poll when the SRQ is set true. Each device on the bus returns the contents of its status byte register in response to this poll. The device whose RQS bit is set to 1 is the device that requested service.

When you read the instrument's status byte register with a serial poll, the RQS bit is reset to 0. Other bits in the register are not affected.

If the status register is configured to SRQ on end-of-measurement and the measurement is in continuous mode, then restarting a measurement (INIT command) can cause the measuring bit to pulse low. This causes an SRQ when you have not actually reached the "end-of-measurement" condition. To avoid this:

1. Set INITiate:CONTinuous off.
2. Set/enable the status registers.
3. Restart the measurement (send INIT).

Status Register System

The hardware status registers are combined to form the instrument status system. Specific status bits are assigned to monitor various aspects of the instrument operation and status. See the diagram of the status system above for information about the bit assignments and status register interconnections.

The Status Byte Register

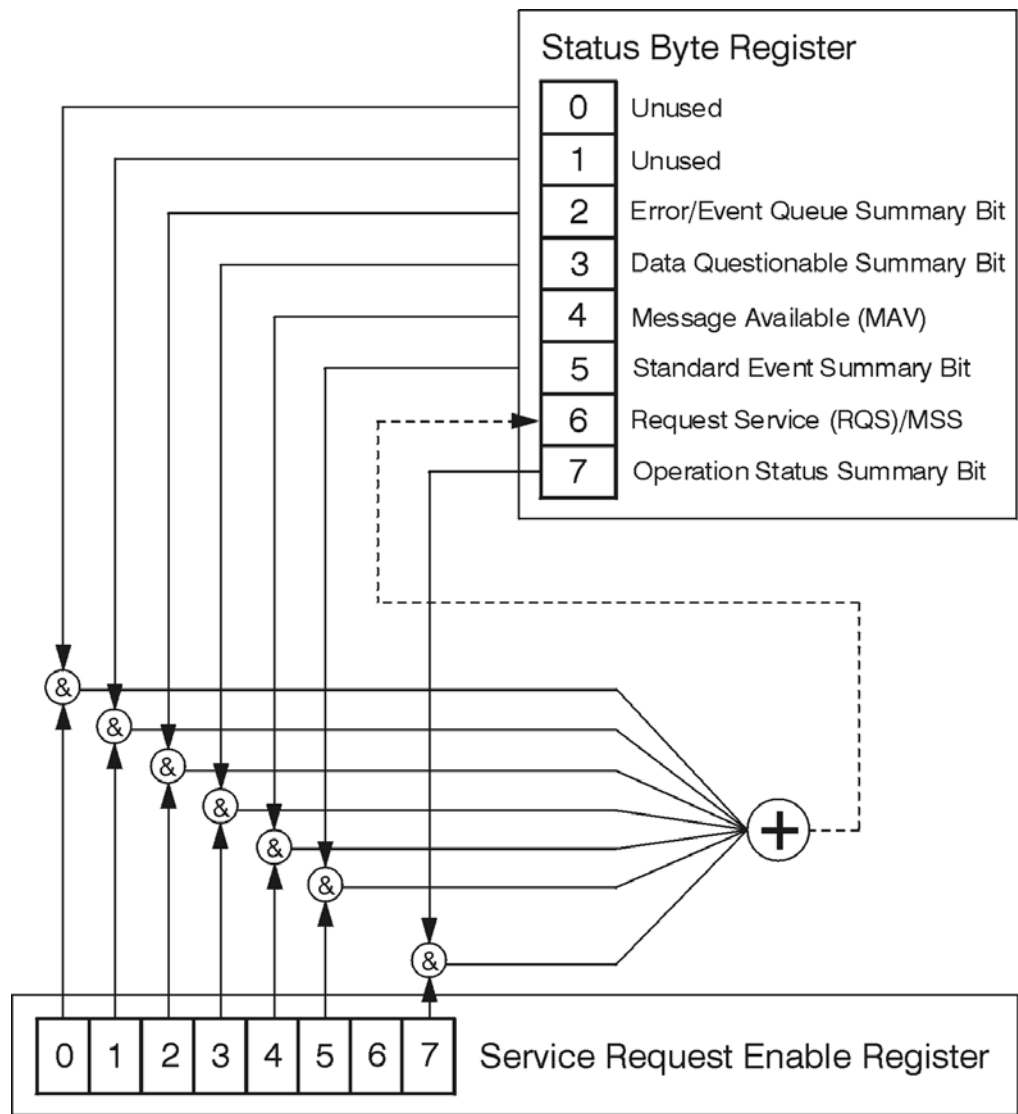

ck776a

The RQS bit is read and reset by a serial poll. The same bit position (MSS) is read, non-destructively by the *STB? command. If you serial poll bit 6 it is read as RQS, but if you send *STB it reads bit 6 as MSS. For more information refer to IEEE 488.2 standards, section 11.

Description	<i>Standard Operation Status Summary Bit</i>	<i>Request Service (RQS) Summary Bit</i>	<i>Standard Event Status Summary Bit</i>	<i>Message Available (MAV)</i>	<i>Data Questionable Status Summary Bit</i>	<i>Error/Event Queue Summary Bit</i>	<i>Unused</i>	<i>Unused</i>	
Bit Number	7	6	5	4	3	2	1	0	

*STB?

Status Byte Register

ck725a

- | Bit | Description |
|------|---|
| 0, 1 | These bits are always set to 0. |
| 2 | A 1 in this bit position indicates that the SCPI error queue is not empty which means that it contains at least one error message. |
| 3 | A 1 in this bit position indicates that the data questionable summary bit has been set. The data questionable event register can then be read to determine the specific condition that caused this bit to be set. |
| 4 | A 1 in this bit position indicates that the instrument has data ready in the output queue. There are no lower status groups that provide input to this bit. |
| 5 | A 1 in this bit position indicates that the standard event summary bit has been set. The standard event status register can then be read to determine the specific event that caused this bit to be set. |
| 6 | A 1 in this bit position indicates that the instrument has at least one reason to report a status change. This bit is also called the master summary status bit (MSS). |
| 7 | A 1 in this bit position indicates that the standard operation summary bit has been set. The standard operation event register can then be read to determine the specific condition that caused this bit to be set. |

To query the status byte register, send the command `*STB?` The response will be the decimal sum of the bits which are set to 1. For example, if bit number 7 and bit number 3 are set to 1, the decimal sum of the 2 bits is 128 plus 8. So the decimal value 136 is returned. The `*STB` command does not clear the status register.

In addition to the status byte register, the status byte group also contains the service request enable register. This register lets you choose which bits in the status byte register will trigger a service request.

Send the `*SRE <integer>` command where `<integer>` is the sum of the decimal values of the bits you want to enable plus the decimal value of bit 6. For example, assume that you want to enable bit 7 so that whenever the standard operation status register summary bit is set to 1 it will trigger a service request. Send the command `*SRE 192` (because $192 = 128 + 64$). You must always add 64 (the numeric value of

Programming the Analyzer
STATUS Subsystem (No equivalent front-panel keys)

RQS bit 6) to your numeric sum when you enable any bits for a service request. The command *SRE? returns the decimal value of the sum of the bits previously enabled with the *SRE <integer> command.

The service request enable register presets to zeros (0).

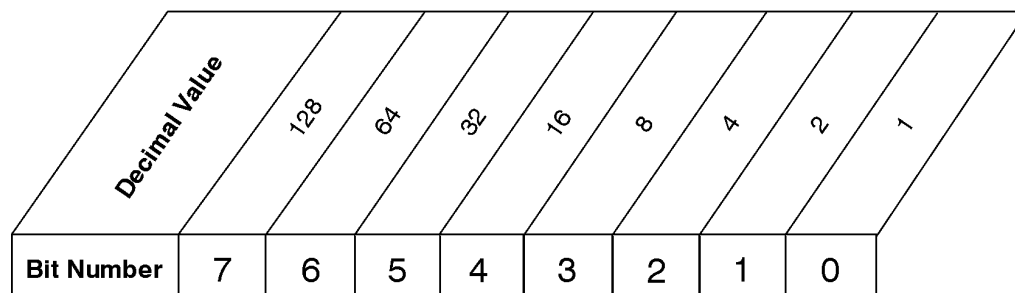

*SRE <num>
 *SRE?

Service Request Enable Register

ck726a

Standard Event Status Register

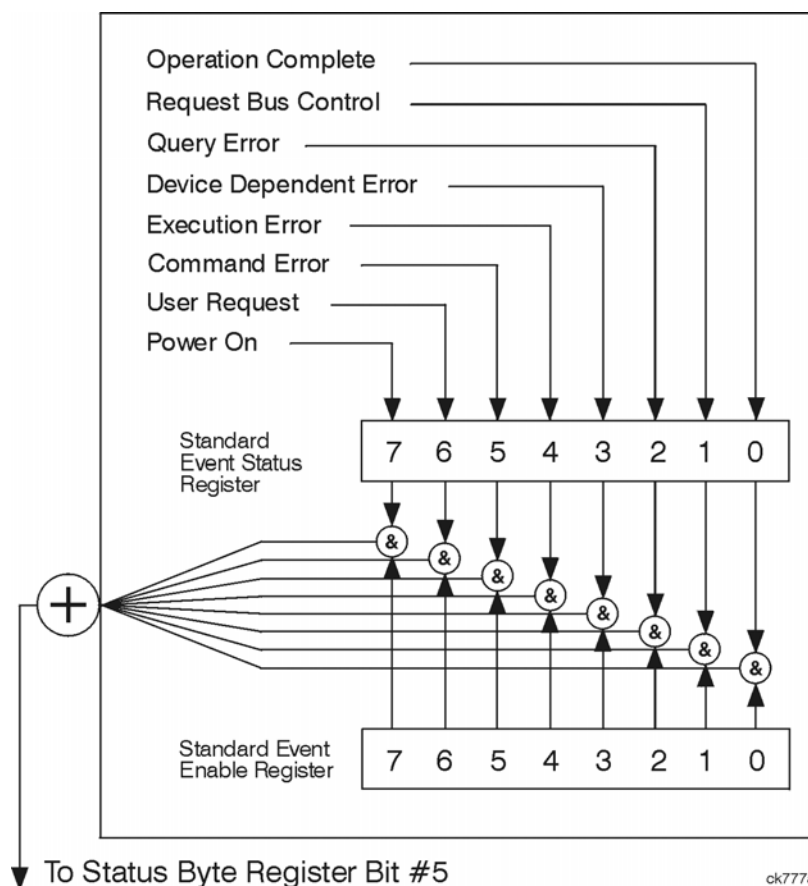

The standard event status register contains the following bits:

Description	Power On	User Request Key (Local)	Command Error	Execution Error	Device Dependent Error	Query Error	Request Control	Operation Complete	
Bit Number	7	6	5	4	3	2	1	0	

*ESR?

Standard Event Status Register

ck727a

Bit	Description
0	A 1 in this bit position indicates that all pending operations were completed following execution of the *OPC command.
1	This bit is for GPIB handshaking to request control. Currently it is set to 0 because there are no implementations where the spectrum analyzer controls another instrument.
2	A 1 in this bit position indicates that a query error has occurred. Query errors have SCPI error numbers from -499 to -400.
3	A 1 in this bit position indicates that a device dependent error has occurred. Device dependent errors have SCPI error numbers from -399 to -300 and 1 to 32767.
4	A 1 in this bit position indicates that an execution error has occurred. Execution errors have SCPI error numbers from -299 to -200.
5	A 1 in this bit position indicates that a command error has occurred. Command errors have SCPI error numbers from -199 to -100.
6	A 1 in this bit position indicates that the LOCAL key has been pressed. This is true even if the instrument is in local lockout mode.
7	A 1 in this bit position indicates that the instrument has been turned off and then on.

The standard event status register is used to determine the specific event that set bit 5 in the status byte register. To query the standard event status register, send the command *ESR?. The response will be the decimal sum of the bits which are enabled (set to 1). For example, if bit number 7 and bit number 3 are enabled, the decimal sum of the 2 bits is 128 plus 8. So the decimal value 136 is returned.

In addition to the standard event status register, the standard event status group also contains a standard event status enable register. This register lets you choose which bits in the standard event status register will set the summary bit (bit 5 of the status byte register) to 1. Send the *ESE <integer> command where <integer> is the sum of the decimal values of the bits you want to enable. For example, to enable bit 7

Programming the Analyzer
STATus Subsystem (No equivalent front-panel keys)

and bit 6 so that whenever either of those bits is set to 1, the standard event status summary bit of the status byte register will be set to 1, send the command *ESE 192 (128 + 64). The command *ESE? returns the decimal value of the sum of the bits previously enabled with the *ESE <integer> command.

The standard event status enable register presets to zeros (0).

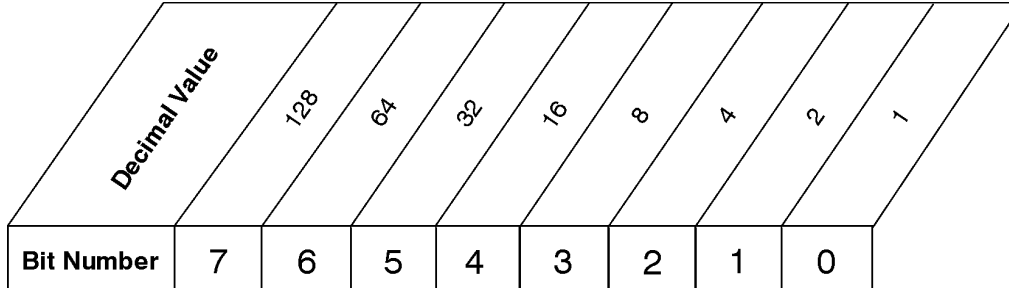

*ESE <num>
 *ESE?

Standard Event Status Enable Register

ck728a

Operation and Questionable Status Registers

The operation and questionable status registers are registers that monitor the overall instrument condition. They are accessed with the STATus:OPERation and STATus:QUESTionable commands in the STATus command subsystem. See the figure at the beginning of this chapter.

Operation Status Register The operation status register monitors the current instrument measurement state. It checks to see if the instrument is calibrating, sweeping, or waiting for a trigger. For more information see the *OPC? command located in the IEEE Common Commands section.

Bit	Condition	Operation
0	Calibrating	The instrument is busy executing its Align Now process
3	Sweeping	The instrument is busy taking a sweep.
4	Measuring	The instrument is busy making a measurement. Measurements often require multiple sweeps. They are initiated by keys under the MEASURE key or with the MEASure group of commands. The bit is valid for most X-Series Modes.
5	Waiting for trigger	The instrument is waiting for the trigger conditions to be met, then it will trigger a sweep or measurement.
8	Paused	The instrument is paused (waiting) because you have pressed the Pause Meas Control key or send the INITiate:PAUSE command. Bit is currently only valid for Modes: ESA/PSA: Spectrum Analysis, Phase Noise, and ESA: Bluetooth, cdmaOne, GSM

Questionable Status Register

The questionable status register monitors the instrument's condition to see if anything questionable has happened to it. It is looking for anything that might cause an error or a bad measurement like a hardware

problem, an out of calibration situation, or a unusual signal. All the bits are summary bits from lower-level event registers.

Bit	Condition	Operation
3	Power summary	The instrument hardware has detected a power unlevelled condition.
4	Temperature summary	The instrument is still warming up.
5	Frequency summary	The instrument hardware has detected an unlocked condition or a problem with the external frequency reference.
8	Calibration summary	The instrument has detected a hardware problem while doing the automatic internal alignment process.
9	Integrity summary	The instrument has detected a questionable measurement condition such as: bad timing, bad signal/data, timeout problem, signal overload, or “meas uncal”.

STATus Subsystem Command Descriptions

The STATus subsystem controls the SCPI-defined instrument status reporting structures. Each status register has a set of five commands used for querying or masking that particular register.

Numeric values for bit patterns can be entered using decimal or hexadecimal representations. (i.e. 0 to 32767 is equivalent to #H0 to #H7FFF. It is also equal to all ones, 11111111111111) See the SCPI Basics information about using bit patterns for variable parameters.

Operation Register

Operation Condition Query This query returns the decimal value of the sum of the bits in the Status Operation Condition register.

NOTE The data in this register is continuously updated and reflects the current conditions.

Mode	All
Remote Command	:STATus:OPERation:CONDition?
Example	STAT:OPER:COND?
Preset	0
SCPI Status Bits/OPC Dependencies	Sequential command
Help Map ID	0
Instrument S/W Revision	Prior to A.02.00

Programming the Analyzer
STATus Subsystem (No equivalent front-panel keys)

Operation Enable This command determines which bits in the Operation Event register, will set the Operation Status Summary bit (bit 7) in the Status Byte Register. The variable <integer> is the sum of the decimal values of the bits you want to enable.

NOTE The preset condition is to have all bits in this enable register set to 0. To have any Operation Events reported to the Status Byte Register, one or more bits need to be set to 1.

Mode	All
Remote Command	:STATus:OPERation:ENABle <integer> :STATus:OPERation:ENABle?
Example	STAT:OPER:ENAB 1 Sets the register so that Align Now operation will be reported to the Status Byte Register.
Preset	0
SCPI Status Bits/OPC Dependencies	Sequential command
Min	0
Max	32767
Help Map ID	0
Instrument S/W Revision	Prior to A.02.00

Operation Event Query This query returns the decimal value of the sum of the bits in the Operation Event register.

NOTE The register requires that the associated PTR or NTR filters be set before a condition register bit can set a bit in the event register. The data in this register is latched until it is queried. Once queried, the register is cleared.

Mode	All
Remote Command	:STATus:OPERation[:EVENT]?
Example	STAT:OPER?
Preset	0
SCPI Status Bits/OPC Dependencies	Sequential command
Help Map ID	0
Instrument S/W Revision	Prior to A.02.00

Operation Negative Transition This command determines which bits in the Operation Condition register will set the corresponding bit in the Operation Event register when the condition register bit has a negative transition (1 to 0). The variable <integer> is the sum of the decimal values of the bits that you want to enable.

Mode	All
Remote Command	:STATus:OPERation:NTRansition <integer> :STATus:OPERation:NTRansition?
Example	STAT:OPER:NTR 1 Align Now operation complete will be reported to the Status Byte Register.
Preset	0
SCPI Status Bits/OPC Dependencies	Sequential command
Min	0
Max	32767
Help Map ID	0
Instrument S/W Revision	Prior to A.02.00

Operation Positive Transition This command determines which bits in the Operation Condition register will set the corresponding bit in the Operation Event register when the condition register bit has a positive transition (0 to 1). The variable <integer> is the sum of the decimal values of the bits that you want to enable.

Mode	All
Remote Command	:STATus:OPERation:PTRansition <integer> :STATus:OPERation:PTRansition?
Example	STAT:OPER:PTR 1 Align Now operation beginning will be reported to the Status Byte Register.
Preset	32767
SCPI Status Bits/OPC Dependencies	Sequential command
Min	0
Max	32767
Help Map ID	0
Instrument S/W Revision	Prior to A.02.00

Presets the Status Byte

Sets bits in most of the enable and transition registers to their default state. It presets all the Transition Filters, Enable Registers, and the Error/Event Queue Enable. It has no effect on Event Registers,

Programming the Analyzer
STATus Subsystem (No equivalent front-panel keys)

Error/Event QUEue, IEEE 488.2 ESE, and SRE Registers as described in IEEE Standard 488.2–1992, IEEE Standard Codes, Formats, Protocols, and Common Commands for Use with ANSI/IEEE Std 488.1–1987. New York, NY, 1992.

Remote Command: :STATus:PRESet
Example: STAT:PRES
Help Map ID: 0
Instrument S/W Revision: Prior to A.02.00

Questionable Register

Questionable Condition This query returns the decimal value of the sum of the bits in the Questionable Condition register.

NOTE The data in this register is continuously updated and reflects the current conditions.

Mode All
Remote Command :STATus:QUEStionable:CONDition?
Example STAT:QUES:COND?
Preset 0
SCPI Status Bits/OPC
Dependencies Sequential command
Help Map ID 0
Instrument S/W Revision Prior to A.02.00

Questionable Enable This command determines which bits in the Questionable Event register will set the Questionable Status Summary bit (bit3) in the Status Byte Register. The variable <integer> is the sum of the decimal values of the bits you want to enable.

NOTE The preset condition is all bits in this enable register set to 0. To have any Questionable Events reported to the Status Byte Register, one or more bits need to be set to 1. The Status Byte Event Register should be queried after each measurement to check the Questionable Status Summary (bit 3). If it is equal to 1, a condition during the test may have made the test results invalid. If it is equal to 0, this indicates that no hardware problem or measurement problem was detected by the analyzer.

Mode All

Remote Command	:STATus:QUESTionable:ENABle 16 Sets the register so that temperature summary will be reported to the Status Byte Register
	:STATus:QUESTionable:ENABle?
Example	STAT:OPER:PTR 1 Align Now operation beginning will be reported to the Status Byte Register.
Preset	0
SCPI Status Bits/OPC Dependencies	Sequential command
Min	0
Max	32767
Help Map ID	0
Instrument S/W Revision	Prior to A.02.00

Questionable Event Query This query returns the decimal value of the sum of the bits in the Questionable Event register.

NOTE The register requires that the associated PTR or NTR filters be set before a condition register bit can set a bit in the event register. The data in this register is latched until it is queried. Once queried, the register is cleared.

Mode	All
Remote Command	:STATus:QUESTionable[:EVENT]?
Example	STAT:QUES?
Preset	0
SCPI Status Bits/OPC Dependencies	Sequential command
Help Map ID	0
Instrument S/W Revision	Prior to A.02.00

Questionable Negative Transition This command determines which bits in the Questionable Condition register will set the corresponding bit in the Questionable Event register when the condition register bit has a negative transition (1 to 0). The variable <integer> is the sum of the decimal values of the bits that you want to enable.

Mode	All
------	-----

Programming the Analyzer

STATus Subsystem (No equivalent front-panel keys)

Remote Command	:STATus:QUESTionable:NTRansition 16 Temperature summary 'questionable cleared' will be reported to the Status Byte Register. :STATus:QUESTionable:NTRansition?
Example	STAT:QUES:NTR 16 Temperature summary 'questionable cleared' will be reported to the Status Byte Register.
Preset	0
SCPI Status Bits/OPC Dependencies	Sequential command
Min	0
Max	32767
Help Map ID	0
Instrument S/W Revision	Prior to A.02.00

Questionable Positive Transition This command determines which bits in the Questionable Condition register will set the corresponding bit in the Questionable Event register when the condition register bit has a positive transition (0 to 1). The variable <integer> is the sum of the decimal values of the bits that you want to enable.

Mode	All
Remote Command	:STATus:QUESTionable:PTRansition <integer> :STATus:QUESTionable:PTRansition?
Example	STAT:QUES:PTR 16 Temperature summary 'questionable asserted' will be reported to the Status Byte Register.
Preset	32767
SCPI Status Bits/OPC Dependencies	Sequential command
Min	0
Max	32767
Help Map ID	0
Instrument S/W Revision	Prior to A.02.00

Questionable Calibration Register

Questionable Calibration Condition This query returns the decimal value of the sum of the bits in the Questionable Calibration Condition register.

NOTE The data in this register is continuously updated and reflects the current conditions.

Mode	All
Remote Command	:STATus:QUESTionable:CALibration:CONDition?
Example	STAT:QUES:CAL:COND?
Preset	0
SCPI Status Bits/OPC Dependencies	Sequential command
Help Map ID	0
Instrument S/W Revision	Prior to A.02.00

Questionable Calibration Enable This command determines which bits in the Questionable Calibration Condition Register will set bits in the Questionable Calibration Event register, which also sets the Calibration Summary bit (bit 8) in the Questionable Register. The variable <integer> is the sum of the decimal values of the bits you want to enable.

Mode	All
Remote Command	:STATus:QUESTionable:CALibration:ENABle <integer> :STATus:QUESTionable:CALibration:ENABle?
Example	STAT:QUES:CAL:ENAB 16384 Can be used to query if an alignment is needed, if you have turned off the automatic alignment process.
SCPI Status Bits/OPC Dependencies	Sequential command
Min	0
Max	32767
Help Map ID	0
Instrument S/W Revision	Prior to A.02.00

Questionable Calibration Event Query This query returns the decimal value of the sum of the bits in the Questionable Calibration Event register.

NOTE The register requires that the associated PTR or NTR filters be set before a condition register bit can set a bit in the event register. The data in this register is latched until it is queried. Once queried, the register is cleared.

Mode	All
Remote Command	:STATus:QUESTionable:CALibration[:EVENT]?

Programming the Analyzer
STATus Subsystem (No equivalent front-panel keys)

Example	STAT:QUES:CAL?
Preset	0
SCPI Status Bits/OPC Dependencies	Sequential command
Help Map ID	0
Instrument S/W Revision	Prior to A.02.00

Questionable Calibration Negative Transition This command determines which bits in the Questionable Calibration Condition register will set the corresponding bit in the Questionable Calibration Event register when the condition register bit has a negative transition (1 to 0). The variable <integer> is the sum of the decimal values of the bits that you want to enable.

Mode	All
Remote Command	:STATus:QUESTionable:CALibration:NTRansition <integer> :STATus:QUESTionable:CALibration:NTRansition?
Example	STAT:QUES:CAL:NTR 16384 Alignment is not required.
Preset	0
SCPI Status Bits/OPC Dependencies	Sequential command
Min	0
Max	32767
Help Map ID	0
Instrument S/W Revision	Prior to A.02.00

Questionable Calibration Positive Transition This command determines which bits in the Questionable Calibration Condition register will set the corresponding bit in the Questionable Calibration Event register when the condition register bit has a positive transition (0 to 1). The variable <integer> is the sum of the decimal values of the bits that you want to enable.

Mode	All
Remote Command	:STATus:QUESTionable:CALibration:PTRansition <integer> :STATus:QUESTionable:CALibration:PTRansition?
Example	STAT:QUES:CAL:PTR 16384 Alignment is required.
Preset	32767
SCPI Status Bits/OPC Dependencies	Sequential command
Min	0

Max	32767
Help Map ID	0
Instrument S/W Revision	Prior to A.02.00

Questionable Calibration Skipped Register

Questionable Calibration Skipped Condition This query returns the decimal value of the sum of the bits in the Questionable Calibration Skipped Condition register.

NOTE The data in this register is continuously updated and reflects the current conditions.

Mode	All
Remote Command	:STATus:QUESTionable:CALibration:SKIPped:CONDition?
Example	STAT:QUES:CAL:SKIP:COND?
Preset	0
SCPI Status Bits/OPC Dependencies	Sequential command
Help Map ID	0
Instrument S/W Revision	Prior to A.02.00

Questionable Calibration Skipped Enable This command determines which bits in the Questionable Calibration Skipped Condition Register will set bits in the Questionable Calibration Skipped Event register, which also sets bit 11 of the Questionable Calibration Register. The variable <integer> is the sum of the decimal values of the bits you want to enable.

Mode	All
Remote Command	:STATus:QUESTionable:CALibration:SKIPped:ENABle <integer> :STATus:QUESTionable:CALibration:SKIPped:ENABle?
Example	STAT:QUES:CAL:SKIP:ENAB 1 Can be used to query if an EMI alignment skipped condition is detected
Preset	32767
SCPI Status Bits/OPC Dependencies	Sequential command
Min	0
Max	32767
Help Map ID	0
Instrument S/W Revision	Prior to A.02.00

Questionable Calibration Skipped Event Query This query returns the decimal value of the sum of the bits in the Questionable Calibration Event register.

NOTE The register requires that the associated PTR or NTR filters be set before a condition register bit can set a bit in the event register. The data in this register is latched until it is queried. Once queried, the register is cleared.

Mode	All
Remote Command	:STATus:QUESTionable:CALibration:SKIPped[:EVENT]?
Example	STAT:QUES:CAL:SKIP?
Preset	0
SCPI Status Bits/OPC Dependencies	Sequential command
Help Map ID	0
Instrument S/W Revision	Prior to A.02.00

Questionable Calibration Skipped Negative Transition This command determines which bits in the Questionable Calibration Skipped Condition register will set the corresponding bit in the Questionable Calibration Skipped Event register when the condition register bit has a negative transition (1 to 0). The variable <integer> is the sum of the decimal values of the bits that you want to enable.

Mode	All
Remote Command	:STATus:QUESTionable:CALibration:SKIPped:NTRansition <integer> :STATus:QUESTionable:CALibration:SKIPped:NTRansition?
Example	STAT:QUES:CAL:SKIP:NTR 1 Align RF skipped is not required.
Preset	0
SCPI Status Bits/OPC Dependencies	Sequential command
Min	0
Max	32767
Help Map ID	0
Instrument S/W Revision	Prior to A.02.00

Questionable Calibration Skipped Positive Transition This command determines which bits in the Questionable Calibration Skipped Condition register will set the corresponding bit in the Questionable Calibration Skipped Event register when the condition register bit has a positive transition (0 to 1). The

variable <integer> is the sum of the decimal values of the bits that you want to enable.

Mode	All
Remote Command	:STATus:QUESTionable:CALibration:SKIPped:PTRansition <integer> :STATus:QUESTionable:CALibration:SKIPped:PTRansition?
Example	STAT:QUES:CAL:SKIP:PTR 1 Align RF skipped is required.
Preset	32767
SCPI Status Bits/OPC Dependencies	Sequential command
Min	0
Max	32767
Help Map ID	0
Instrument S/W Revision	Prior to A.02.00

Questionable Calibration Extended Failure Register

Questionable Calibration Extended Failure Condition This query returns the decimal value of the sum of the bits in the Questionable Calibration Extended Failure Condition register.

NOTE The data in this register is continuously updated and reflects the current conditions.

Mode	All
Remote Command	:STATus:QUESTionable:CALibration:EXTended:FAILure:CONDi tion?
Example	STAT:QUES:CAL:EXT:FAIL:COND?
Preset	0
SCPI Status Bits/OPC Dependencies	Sequential command
Help Map ID	0
Instrument S/W Revision	Prior to A.02.00

Questionable Calibration Extended Failure Enable This command determines which bits in the Questionable Calibration Extended Failure Condition Register will set bits in the Questionable Calibration Extended Failure Event register, which also sets bit 9 of the Questionable Calibration Register. The variable <integer> is the sum of the decimal values of the bits you want to enable.

Mode	All
------	-----

Programming the Analyzer
STATus Subsystem (No equivalent front-panel keys)

Remote Command	:STATus:QUESTionable:CALibration:EXTended:FAILure:ENABLe <integer> :STATus:QUESTionable:CALibration:EXTended:FAILure:ENABLe?
Example	STAT:QUES:CAL:EXT:FAIL:ENAB 1 Can be used to query if an EMI conducted alignment is needed.
Preset	32767
SCPI Status Bits/OPC Dependencies	Sequential command
Min	0
Max	32767
Help Map ID	0
Instrument S/W Revision	Prior to A.02.00

Questionable Calibration Extended Failure Event Query This query returns the decimal value of the sum of the bits in the Questionable Calibration Extended Failure Event register.

NOTE The register requires that the associated PTR or NTR filters be set before a condition register bit can set a bit in the event register. The data in this register is latched until it is queried. Once queried, the register is cleared.

Mode	All
Remote Command	:STATus:QUESTionable:CALibration:EXTended:FAILure[:EVENT]?
Example	STAT:QUES:CAL:EXT:FAIL?
Preset	0
SCPI Status Bits/OPC Dependencies	Sequential command
Help Map ID	0
Instrument S/W Revision	Prior to A.02.00

Questionable Calibration Extended Failure Negative Transition This command determines which bits in the Questionable Calibration Extended Failure Condition register will set the corresponding bit in the Questionable Calibration Extended Failure Event register when the condition register bit has a negative transition (1 to 0). The variable <integer> is the sum of the decimal values of the bits that you want to enable.

Mode	All
------	-----

Remote Command	:STATus:QUESTionable:CALibration:EXTended:FAILure:NTRan sition <integer> :STATus:QUESTionable:CALibration:EXTended:FAILure:NTRan sition?
Example	STAT:QUES:CAL:EXT:FAIL:NTR 1 EMI conducted align failure is not required.
Preset	0
SCPI Status Bits/OPC Dependencies	Sequential command
Min	0
Max	32767
Help Map ID	0
Instrument S/W Revision	Prior to A.02.00

Questionable Calibration Extended Failure Positive Transition This command determines which bits in the Questionable Calibration Extended Failure Condition register will set the corresponding bit in the Questionable Calibration Extended Failure Event register when the condition register bit has a positive transition (0 to 1). The variable <integer> is the sum of the decimal values of the bits that you want to enable.

Mode	All
Remote Command	:STATus:QUESTionable:CALibration:EXTended:FAILure:PTRan sition <integer> :STATus:QUESTionable:CALibration:EXTended:FAILure:PTRan sition?
Example	STAT:QUES:CAL:EXT:FAIL:PTR 1 EMI conducted align failure is required.
Preset	32767
SCPI Status Bits/OPC Dependencies	Sequential command
Min	0
Max	32767
Help Map ID	0
Instrument S/W Revision	Prior to A.02.00

Questionable Calibration Extended Needed Register

Questionable Calibration Extended Needed Condition This query returns the decimal value of the sum of the bits in the Questionable Calibration Extended Needed Condition register.

NOTE The data in this register is continuously updated and reflects the current conditions.

Mode	All
Remote Command	:STATus:QUESTionable:CALibration:EXTended:NEEDED:CONDition?
Example	STAT:QUES:CAL:EXT:NEED:COND?
Preset	0
SCPI Status Bits/OPC Dependencies	Sequential command
Help Map ID	0
Instrument S/W Revision	Prior to A.02.00

Questionable Calibration Extended Needed Enable This command determines which bits in the Questionable Calibration Extended Needed Condition Register will set bits in the Questionable Calibration Extended Needed Event register, which also sets bit 14 of the Questionable Calibration Register. The variable <integer> is the sum of the decimal values of the bits you want to enable.

Mode	All
Remote Command	:STATus:QUESTionable:CALibration:EXTended:NEEDED:ENABle <integer> :STATus:QUESTionable:CALibration:EXTended:NEEDED:ENABle?
Example	STAT:QUES:CAL:EXT:NEED:ENAB 2 Can be used to query if an EMI conducted alignment is needed.
Preset	32767
SCPI Status Bits/OPC Dependencies	Sequential command
Min	0
Max	32767
Help Map ID	0
Instrument S/W Revision	Prior to A.02.00

Questionable Calibration Extended Needed Event Query This query returns the decimal value of the sum of the bits in the Questionable Calibration Extended Needed Event register.

NOTE The register requires that the associated PTR or NTR filters be set before a condition register bit can set a bit in the event register. The data in this register is

latched until it is queried. Once queried, the register is cleared.

Mode	All
Remote Command	:STATus:QUESTionable:CALibration:EXTended:NEEDed[:EVENT]?
Example	STAT:QUES:CAL:EXT:NEED?
Preset	0
SCPI Status Bits/OPC Dependencies	Sequential command
Help Map ID	0
Instrument S/W Revision	Prior to A.02.00

Questionable Calibration Extended Needed Negative Transition This command determines which bits in the Questionable Calibration Extended Needed Condition register will set the corresponding bit in the Questionable Calibration Extended Needed Event register when the condition register bit has a negative transition (1 to 0). The variable <integer> is the sum of the decimal values of the bits that you want to enable.

Mode	All
Remote Command	:STATus:QUESTionable:CALibration:EXTended:NEEDed:NTRansition <integer> :STATus:QUESTionable:CALibration:EXTended:NEEDed:NTRansition?
Example	STAT:QUES:CAL:EXT:NEED:NTR 2 Align EMI conducted is not required.
Preset	0
SCPI Status Bits/OPC Dependencies	Sequential command
Min	0
Max	32767
Help Map ID	0
Instrument S/W Revision	Prior to A.02.00

Questionable Calibration Extended Needed Positive Transition This command determines which bits in the Questionable Calibration Extended Needed Condition register will set the corresponding bit in the Questionable Calibration Extended Needed Event register when the condition register bit has a positive transition (0 to 1). The variable <integer> is the sum of the decimal values of the bits that you want to enable.

Mode	All
------	-----

Programming the Analyzer
STATus Subsystem (No equivalent front-panel keys)

Remote Command	:STATus:QUEStionable:CALibration:EXTended:NEEDed:PTRansition <integer> :STATus:QUEStionable:CALibration:EXTended:NEEDed:PTRansition?
Example	STAT:QUES:CAL:EXT:NEED:PTR 2 Align EMI conducted is required.
Preset	32767
SCPI Status Bits/OPC Dependencies	Sequential command
Min	0
Max	32767
Help Map ID	0
Instrument S/W Revision	Prior to A.02.00

Questionable Frequency Register

Questionable Frequency Condition This query returns the decimal value of the sum of the bits in the Questionable Frequency Condition register.

NOTE The data in this register is continuously updated and reflects the current conditions.

Mode	All
Remote Command	:STATus:QUEStionable:FREQuency:CONDition?
Example	STAT:QUES:FREQ:COND?
Preset	0
SCPI Status Bits/OPC Dependencies	Sequential command
Help Map ID	0
Instrument S/W Revision	Prior to A.02.00

Questionable Frequency Enable This command determines which bits in the Questionable Frequency Condition Register will set bits in the Questionable Frequency Event register, which also sets the Frequency Summary bit (bit 5) in the Questionable Register. The variable <integer> is the sum of the decimal values of the bits you want to enable.

Mode	All
Remote Command	:STATus:QUEStionable:FREQuency:ENABle <integer> :STATus:QUEStionable:FREQuency:ENABle?

Example	STAT:QUES:FREQ:ENAB 2 Frequency Reference Unlocked will be reported to the Frequency Summary of the Status Questionable register.
Preset	32767
SCPI Status Bits/OPC Dependencies	Sequential command
Min	0
Max	32767
Help Map ID	0
Instrument S/W Revision	Prior to A.02.00

Questionable Frequency Event Query This query returns the decimal value of the sum of the bits in the Questionable Frequency Event register.

NOTE The register requires that the associated PTR or NTR filters be set before a condition register bit can set a bit in the event register. The data in this register is latched until it is queried. Once queried, the register is cleared.

Mode	All
Remote Command	:STATus:QUESTionable:FREQuency[:EVENT]?
Example	STAT:QUES:FREQ?
Preset	0
SCPI Status Bits/OPC Dependencies	Sequential command
Help Map ID	0
Instrument S/W Revision	Prior to A.02.00

Questionable Frequency Negative Transition This command determines which bits in the Questionable Frequency Condition register will set the corresponding bit in the Questionable Frequency Event register when the condition register bit has a negative transition (1 to 0). The variable <integer> is the sum of the decimal values of the bits that you want to enable.

Mode	All
Remote Command	:STATus:QUESTionable:FREQuency:NTRansition <integer> :STATus:QUESTionable:FREQuency:NTRansition?
Example	STAT:QUES:FREQ:NTR 2 Frequency Reference 'regained lock' will be reported to the Frequency Summary of the Status Questionable register.
Preset	0

Programming the Analyzer
STATus Subsystem (No equivalent front-panel keys)

SCPI Status Bits/OPC Dependencies	Sequential command
Min	0
Max	32767
Help Map ID	0
Instrument S/W Revision	Prior to A.02.00

Questionable Frequency Positive Transition This command determines which bits in the Questionable Frequency Condition register will set the corresponding bit in the Questionable Frequency Event register when the condition register bit has a positive transition (0 to 1). The variable <integer> is the sum of the decimal values of the bits that you want to enable.

Mode	All
Remote Command	:STATus:QUESTionable:FREQuency:PTRansition <integer> :STATus:QUESTionable:FREQuency:PTRansition?
Example	STAT:QUES:FREQ:PTR 2 Frequency Reference 'became unlocked' will be reported to the Frequency Summary of the Status Questionable register.
Preset	32767
SCPI Status Bits/OPC Dependencies	Sequential command
Min	0
Max	32767
Help Map ID	0
Instrument S/W Revision	Prior to A.02.00

Questionable Integrity Register

Questionable Integrity Condition This query returns the decimal value of the sum of the bits in the Questionable Integrity Condition register.

NOTE The data in this register is continuously updated and reflects the current conditions.

Mode	All
Remote Command	:STATus:QUESTionable:INTEgrity:CONDition?
Example	STAT:QUES:INT:COND?
Preset	0
SCPI Status Bits/OPC Dependencies	Sequential command

Help Map ID 0
 Instrument S/W Revision Prior to A.02.00

Questionable Integrity Enable This command determines which bits in the Questionable Integrity Condition Register will set bits in the Questionable Integrity Event register, which also sets the Integrity Summary bit (bit 9) in the Questionable Register. The variable <integer> is the sum of the decimal values of the bits you want to enable.

Mode All
 Remote Command :STATus:QUESTionable:INTEgrity:ENABle <integer>
 :STATus:QUESTionable:INTEgrity:ENABle?
 Example STAT:QUES:INT:ENAB 8 Measurement Uncalibrated Summary will be reported to the Integrity Summary of the Status Questionable register.
 Preset 32767
 SCPI Status Bits/OPC Sequential command
 Dependencies
 Min 0
 Max 32767
 Help Map ID 0
 Instrument S/W Revision Prior to A.02.00

Questionable Integrity Event Query This query returns the decimal value of the sum of the bits in the Questionable Integrity Event register.

NOTE The register requires that the associated PTR or NTR filters be set before a condition register bit can set a bit in the event register. The data in this register is latched until it is queried. Once queried, the register is cleared.

Mode All
 Remote Command :STATus:QUESTionable:INTEgrity[:EVENT]?
 Example STAT:QUES:INT?
 Preset 0
 SCPI Status Bits/OPC Sequential command
 Dependencies
 Help Map ID 0
 Instrument S/W Revision Prior to A.02.00

Questionable Integrity Negative Transition This command determines which bits in the

Programming the Analyzer
STATus Subsystem (No equivalent front-panel keys)

Questionable Integrity Condition register will set the corresponding bit in the Questionable Integrity Event register when the condition register bit has a negative transition (1 to 0)
The variable <integer> is the sum of the decimal values of the bits that you want to enable.

Mode	All
Remote Command	:STATus:QUESTionable:INTEgrity:NTRansition <integer> :STATus:QUESTionable:INTEgrity:NTRansition?
Example	STAT:QUES:INT:NTR 8 Measurement 'regained calibration' Summary will be reported to the Integrity Summary of the Status Questionable register.
Preset	0
SCPI Status Bits/OPC Dependencies	Sequential command
Min	0
Max	32767
Help Map ID	0
Instrument S/W Revision	Prior to A.02.00

Questionable Integrity Positive Transition This command determines which bits in the Questionable Integrity Condition register will set the corresponding bit in the Questionable Integrity Event register when the condition register bit has a positive transition (0 to 1). The variable <integer> is the sum of the decimal values of the bits that you want to enable.

Mode	All
Remote Command	:STATus:QUESTionable:INTEgrity:PTRansition <integer> :STATus:QUESTionable:INTEgrity:PTRansition?
Example	STAT:QUES:INT:PTR 8 Measurement 'became uncalibrated' Summary will be reported to the Integrity Summary of the Status Questionable register.
Preset	32767
SCPI Status Bits/OPC Dependencies	Sequential command
Min	0
Max	32767
Help Map ID	0
Instrument S/W Revision	Prior to A.02.00

Questionable Integrity Signal Register

Questionable Integrity Signal Condition This query returns the decimal value of the sum of the bits in the Questionable Integrity Signal Condition register.

NOTE The data in this register is continuously updated and reflects the current conditions.

Mode	All
Remote Command	:STATUS:QUESTIONABLE:INTEGRITY:SIGNAl:CONDition?
Example	STAT:QUES:INT:SIGN:COND?
Preset	0
SCPI Status Bits/OPC Dependencies	Sequential command
Help Map ID	0
Instrument S/W Revision	Prior to A.02.00

Questionable Integrity Signal Enable This command determines which bits in the Questionable Integrity Signal Condition Register will set bits in the Questionable Integrity Signal Event register, which also sets the Integrity Summary bit (bit 9) in the Questionable Register. The variable <integer> is the sum of the decimal values of the bits you want to enable.

Mode	All
Remote Command	:STATUS:QUESTIONABLE:INTEGRITY:SIGNAl:ENABle <integer> :STATUS:QUESTIONABLE:INTEGRITY:SIGNAl:ENABle?
Example	STAT:QUES:INT:SIGN:ENAB 4 Burst Not Found will be reported to the Integrity Summary of the Status Questionable register.
Preset	32767
SCPI Status Bits/OPC Dependencies	Sequential command
Min	0
Max	32767
Help Map ID	0
Instrument S/W Revision	Prior to A.02.00

Questionable Integrity Signal Event Query This query returns the decimal value of the sum of the bits in the Questionable Integrity Signal Event register.

NOTE The register requires that the associated PTR or NTR filters be set before a condition register bit can set a bit in the event register. The data in this register is latched until it is queried. Once queried, the register is cleared.

Mode	All
------	-----

Programming the Analyzer
STATus Subsystem (No equivalent front-panel keys)

Remote Command	:STATus:QUEStionable:INTEgrity:SIGNal[:EVENT]?
Example	STAT:QUES:INT:SIGN?
Preset	0
SCPI Status Bits/OPC Dependencies	Sequential command
Help Map ID	0
Instrument S/W Revision	Prior to A.02.00

Questionable Integrity Signal Negative Transition This command determines which bits in the Questionable Integrity Signal Condition register will set the corresponding bit in the Questionable Integrity Signal Event register when the condition register bit has a negative transition (1 to 0). The variable <integer> is the sum of the decimal values of the bits that you want to enable.

Mode	All
Remote Command	:STATus:QUEStionable:INTEgrity:SIGNal:NTRansition <integer> :STATus:QUEStionable:INTEgrity:SIGNal:NTRansition?
Example	STAT:QUES:INT:SIGN:NTR 4 Burst found will be reported to the Integrity Summary of the Status Questionable register.
Preset	0
SCPI Status Bits/OPC Dependencies	Sequential command
Min	0
Max	32767
Help Map ID	0
Instrument S/W Revision	Prior to A.02.00

Questionable Integrity Signal Positive Transition This command determines which bits in the Questionable Integrity Signal Condition register will set the corresponding bit in the Questionable Integrity Signal Event register when the condition register bit has a positive transition (0 to 1). The variable <integer> is the sum of the decimal values of the bits that you want to enable.

Mode	All
Remote Command	:STATus:QUEStionable:INTEgrity:SIGNal:PTRansition <integer> :STATus:QUEStionable:INTEgrity:SIGNal:PTRansition?
Example	STAT:QUES:INT:SIGN:PTR 4 Burst not found will be reported to the Integrity Summary of the Status Questionable register.
Preset	32767

SCPI Status Bits/OPC Dependencies	Sequential command
Min	0
Max	32767
Help Map ID	0
Instrument S/W Revision	Prior to A.02.00

Questionable Integrity Uncalibrated Register

Questionable Integrity Uncalibrated Condition This query returns the decimal value of the sum of the bits in the Questionable Integrity Uncalibrated Condition register.

NOTE The data in this register is continuously updated and reflects the current conditions.

Mode	All
Remote Command	:STATus:QUESTionable:INTEgrity:UNCalibrated:CONDition?
Example	STAT:QUES:INT:UNC:COND?
Preset	0
SCPI Status Bits/OPC Dependencies	Sequential command
Help Map ID	0
Instrument S/W Revision	Prior to A.02.00

Questionable Integrity Uncalibrated Enable This command determines which bits in the Questionable Integrity Uncalibrated Condition Register will set bits in the Questionable Integrity Uncalibrated Event register, which also sets the Data Uncalibrated Summary bit (bit 3) in the Questionable Integrity Register. The variable <integer> is the sum of the decimal values of the bits you want to enable.

Mode	All
Remote Command	:STATus:QUESTionable:INTEgrity:UNCalibrated:ENABle :STATus:QUESTionable:INTEgrity:UNCalibrated:ENABle?
Example	STAT:QUES:INT:UNC:ENAB 1 Oversweep (Meas Uncal) will be reported to the Integrity Summary of the Status Questionable register.
Preset	32767
SCPI Status Bits/OPC Dependencies	Sequential command
Min	0

Programming the Analyzer
STATus Subsystem (No equivalent front-panel keys)

Max	32767
Help Map ID	0
Instrument S/W Revision	Prior to A.02.00

Questionable Integrity Uncalibrated Event Query This query returns the decimal value of the sum of the bits in the Questionable Integrity Uncalibrated Event register.

NOTE The register requires that the associated PTR or NTR filters be set before a condition register bit can set a bit in the event register. The data in this register is latched until it is queried. Once queried, the register is cleared.

Mode	All
Remote Command	:STATus:QUESTionable:INTEgrity:UNCalibrated[:EVENT]?
Example	STAT:QUES:INT:UNC?
Preset	0
SCPI Status Bits/OPC Dependencies	Sequential command
Help Map ID	0
Instrument S/W Revision	Prior to A.02.00

Questionable Integrity Uncalibrated Negative Transition This command determines which bits in the Questionable Integrity Uncalibrated Condition register will set the corresponding bit in the Questionable Integrity Uncalibrated Event register when the condition register bit has a negative transition (1 to 0). The variable <integer> is the sum of the decimal values of the bits that you want to enable.

Mode	All
Remote Command	:STATus:QUESTionable:INTEgrity:UNCalibrated:NTRansition <integer> :STATus:QUESTionable:INTEgrity:UNCalibrated:NTRansition ?
Example	STAT:QUES:INT:UNC:NTR 1 Oversweep cleared will be reported to the Integrity Summary of the Status Questionable register.
Preset	0
SCPI Status Bits/OPC Dependencies	Sequential command
Min	0
Max	32767

Help Map ID 0
 Instrument S/W Revision Prior to A.02.00

Questionable Integrity Uncalibrated Positive Transition This command determines which bits in the Questionable Integrity Uncalibrated Condition register will set the corresponding bit in the Questionable Integrity Uncalibrated Event register when the condition register bit has a positive transition (0 to 1). The variable <integer> is the sum of the decimal values of the bits that you want to enable.

Mode All
 Remote Command :STATus:QUESTionable:INTEgrity:UNCalibrated:PTRansition
 <integer>
 :STATus:QUESTionable:INTEgrity:UNCalibrated:PTRansition
 ?
 Example STAT:QUES:INT:UNC:PTR 1 Oversweep (Meas Uncal) occurred will be
 reported to the Integrity Summary of the Status Questionable register.
 Preset 32767
 SCPI Status Bits/OPC
 Dependencies Sequential command
 Min 0
 Max 32767
 Help Map ID 0
 Instrument S/W Revision Prior to A.02.00

Questionable Power Register

Questionable Power Condition This query returns the decimal value of the sum of the bits in the Questionable Power Condition register.

NOTE The data in this register is continuously updated and reflects the current conditions.

Mode All
 Remote Command :STATus:QUESTionable:POWer:CONDition?
 Example STAT:QUES:POW:COND?
 Preset 0
 SCPI Status Bits/OPC
 Dependencies Sequential command
 Help Map ID 0

Programming the Analyzer
STATus Subsystem (No equivalent front-panel keys)

Instrument S/W Revision Prior to A.02.00

Questionable Power Enable This command determines which bits in the Questionable Power Condition Register will set bits in the Questionable Power Event register, which also sets the Power Summary bit (bit 3) in the Questionable Register. The variable <integer> is the sum of the decimal values of the bits you want to enable.

Mode	All
Remote Command	:STATus:QUESTionable:POWer:ENABle <integer> :STATus:QUESTionable:POWer:ENABle?
Example	STAT:QUES:POW:ENAB 32 50 MHz Input Pwr too High for Cal will be reported to the Power Summary of the Status Questionable register.
Preset	32767
SCPI Status Bits/OPC Dependencies	Sequential command
Min	0
Max	32767
Help Map ID	0
Instrument S/W Revision	Prior to A.02.00

Questionable Power Event Query This query returns the decimal value of the sum of the bits in the Questionable Power Event register.

NOTE The register requires that the associated PTR or NTR filters be set before a condition register bit can set a bit in the event register. The data in this register is latched until it is queried. Once queried, the register is cleared.

Mode	All
Remote Command	:STATus:QUESTionable:POWer[:EVENT]?
Example	STAT:QUES:POW?
Preset	0
SCPI Status Bits/OPC Dependencies	Sequential command
Help Map ID	0
Instrument S/W Revision	Prior to A.02.00

Questionable Power Negative Transition This command determines which bits in the Questionable Power Condition register will set the corresponding bit in the Questionable Power Event register when the condition register bit has a negative transition (1 to 0). The variable <integer> is the sum of the

decimal values of the bits that you want to enable.

Mode	All
Remote Command	:STATus:QUESTionable:POWer:NTRansition <integer> :STATus:QUESTionable:POWer:NTRansition?
Example	STAT:QUES:POW:NTR 32 50 MHz Input Power became OK for Cal will be reported to the Power Summary of the Status Questionable register.
Preset	0
SCPI Status Bits/OPC Dependencies	Sequential command
Min	0
Max	32767
Help Map ID	0
Instrument S/W Revision	Prior to A.02.00

Questionable Power Positive Transition This command determines which bits in the Questionable Power Condition register will set the corresponding bit in the Questionable Power Event register when the condition register bit has a positive transition (0 to 1). The variable <integer> is the sum of the decimal values of the bits that you want to enable.

Mode	All
Remote Command	:STATus:QUESTionable:POWer:PTRansition <integer> :STATus:QUESTionable:POWer:PTRansition?>
Example	STAT:QUES:POW:PTR 32 50 MHz Input Power became too high for Cal will be reported to the Power Summary of the Status Questionable register.
Preset	32767
SCPI Status Bits/OPC Dependencies	Sequential command
Min	0
Max	32767
Help Map ID	0
Instrument S/W Revision	Prior to A.02.00

Questionable Temperature Register

Questionable Temperature Condition This query returns the decimal value of the sum of the bits in the Questionable Temperature Condition register.

NOTE The data in this register is continuously updated and reflects the current conditions.

Mode	All
Remote Command	:STATus:QUEStionable:TEMPerature:CONDition?
Example	STAT:QUES:TEMP:COND?
Preset	0
SCPI Status Bits/OPC Dependencies	Sequential command
Help Map ID	0
Instrument S/W Revision	Prior to A.02.00

Questionable Temperature Enable This command determines which bits in the Questionable Temperature Condition Register will set bits in the Questionable Temperature Event register, which also sets the Temperature Summary bit (bit 4) in the Questionable Register. The variable <integer> is the sum of the decimal values of the bits you want to enable.

Mode	All
Remote Command	:STATus:QUEStionable:TEMPerature:ENABle <integer> :STATus:QUEStionable:TEMPerature:ENABle?
Example	STAT:QUES:TEMP:ENAB 1 Reference Oscillator Oven Cold will be reported to the Temperature Summary of the Status Questionable register.
Preset	32767
SCPI Status Bits/OPC Dependencies	Sequential command
Min	0
Max	32767
Help Map ID	0
Instrument S/W Revision	Prior to A.02.00

Questionable Temperature Event Query This query returns the decimal value of the sum of the bits in the Questionable Temperature Event register.

NOTE The register requires that the associated PTR or NTR filters be set before a condition register bit can set a bit in the event register. The data in this register is latched until it is queried. Once queried, the register is cleared

Mode	All
------	-----

Remote Command	:STATus:QUESTionable:TEMPerature[:EVENT]?
Example	STAT:QUES:TEMP?
Preset	0
SCPI Status Bits/OPC Dependencies	Sequential command
Help Map ID	0
Instrument S/W Revision	Prior to A.02.00

Questionable Temperature Negative Transition This command determines which bits in the Questionable Temperature Condition register will set the corresponding bit in the Questionable Temperature Event register when the condition register bit has a negative transition (1 to 0). The variable <integer> is the sum of the decimal values of the bits that you want to enable.

Mode	All
Remote Command	:STATus:QUESTionable:TEMPerature:NTRansition <integer> :STATus:QUESTionable:TEMPerature:NTRansition?
Example	STAT:QUES:TEMP:NTR 1 Reference Oscillator Oven not cold will be reported to the Temperature Summary of the Status Questionable register.
Preset	0
SCPI Status Bits/OPC Dependencies	Sequential command
Min	0
Max	32767
Help Map ID	0
Instrument S/W Revision	Prior to A.02.00

Questionable Temperature Positive Transition This command determines which bits in the Questionable Temperature Condition register will set the corresponding bit in the Questionable Temperature Event register when the condition register bit has a positive transition (0 to 1). The variable <integer> is the sum of the decimal values of the bits that you want to enable.

Mode	All
Remote Command	:STATus:QUESTionable:TEMPerature:PTRansition <integer> :STATus:QUESTionable:TEMPerature:PTRansition?
Example	STAT:QUES:TEMP:PTR 1 Reference Oscillator Oven became cold will be reported to the Temperature Summary of the Status Questionable register.
Preset	32767

Programming the Analyzer
STATus Subsystem (No equivalent front-panel keys)

SCPI Status Bits/OPC Dependencies	Sequential command
Min	0
Max	32767
Help Map ID	0
Instrument S/W Revision	Prior to A.02.00

IEEE Common GPIB Commands

Numeric values for bit patterns can be entered using decimal or hexi-decimal representations. (i.e. 0 to 32767 is equivalent to #H0 to #H7FFF).

Calibration Query

*CAL? Performs a full alignment and returns a number indicating the success of the alignment. A zero is returned if the alignment is successful. A one is returned if any part of the alignment fails. The equivalent SCPI command is CALibrate[:ALL]?

Clear Status

Clears the status byte register. It does this by emptying the error queue and clearing all bits in all of the event registers. The status byte register summarizes the states of the other registers. It is also responsible for generating service requests.

Key Path	No equivalent key. Related key System, Show Errors, Clear Error Queue
Remote Command	*CLS
Example	*CLS Clears the error queue and the Status Byte Register.
Remote Command Notes	For related commands, see the SYSTem:ERRor[:NEXT]? command. See also the STATus:PRESet command and all commands in the STATus subsystem.
SCPI Status Bits/OPC Dependencies	Resets all bits in all event registers to 0, which resets all the status byte register bits to 0 also.
Help Map ID	0
Instrument S/W Revision	Prior to A.02.00

Standard Event Status Enable

Selects the desired bits from the standard event status enable register. This register monitors I/O errors and synchronization conditions such as operation complete, request control, query error, device dependent error, status execution error, command error, and power on. The selected bits are OR'd to become a summary bit (bit 5) in the byte register which can be queried.

The query returns the state of the standard event status enable register.

Key Path	No equivalent key. Related key System, Show Errors, Clear Error Queue
Remote Command	*ESE <integer> *ESE?

Example	*ESE 36 Enables the Standard Event Status Register to monitor query and command errors (bits 2 and 5). *ESE? Returns a 36 indicating that the query and command status bits are enabled.
Remote Command Notes	For related commands, see the STATus subsystem and SYSTem:ERRor[:NEXT]? commands.
Preset	255
SCPI Status Bits/OPC Dependencies	Event Enable Register of the Standard Event Status Register.
State Saved	Not saved in state.
Min	0
Max	255
Help Map ID	0
Instrument S/W Revision	Prior to A.02.00

Standard Event Status Register Query

Queries and clears the standard event status event register. (This is a destructive read.) The value returned is a hexadecimal number that reflects the current state (0/1) of all the bits in the register.

Remote Command:	*ESR?
Example:	*ESR? Returns a 1 if there is either a query or command error, otherwise it returns a zero.
Remote Command Notes:	For related commands, see the STATus subsystem commands.
Preset:	0
SCPI Status Bits/OPC Dependencies:	Standard Event Status Register (bits 0 – 7).
Min:	0
Max:	255
Help Map ID:	0
Instrument S/W Revision:	Prior to A.02.00

Identification Query

Returns a string of instrument identification information. The string will contain the model number, serial number, and firmware revision.

The response is organized into four fields separated by commas. The field definitions are as follows:

- Manufacturer

- Model
- Serial number
- Firmware version
-

Key Path	No equivalent key. See related key System, Show System.
Remote Command	*IDN?
Example	*IDN? Returns instrument identification information, such as: Agilent Technologies,N9020A,US01020004,A.01.02
Help Map ID	0
Instrument S/W Revision	Prior to A.02.00

Operation Complete

The *OPC command sets bit 0 in the standard event status register (SER) to “1” when pending operations have finished, that is when all overlapped commands are complete. It does not hold off subsequent operations. You can determine when the overlapped commands have completed either by polling the OPC bit in SER, or by setting up the status system such that a service request (SRQ) is asserted when the OPC bit is set.

The *OPC? query returns a “1” after all the current overlapped commands are complete. So it holds off subsequent commands until the "1" is returned, then the program continues. This query can be used to synchronize events of other instruments on the external bus.

Remote Command:	*OPC *OPC?
Example:	INIT:CONT 0 Selects single sweeping. INIT:IMM Initiates a sweep. *OPC? Holds off any further commands until the sweep is complete.
SCPI Status Bits/OPC Dependencies:	Not global to all remote ports or front panel. *OPC only considers operation that was initiated on the same port as the *OPC command was issued from. *OPC is an overlapped command, but *OPC? is sequential.
Help Map ID:	0
Instrument S/W Revision:	Prior to A.02.00

Query Instrument Options

Returns a string of all the installed instrument options. It is a comma separated list with quotes, such as: “503,P03,PFR”.

To be IEEE compliant, this command should return an arbitrary ascii variable that would not begin and

end with quotes. But the quotes are needed to be backward compatible with previous Spectrum Analyzer products and software. So, the actual implementation will use arbitrary ascii. But quotes will be sent as the first and last ascii characters that are sent with the comma-separated option list.

Remote Command: *OPT?
Help Map ID: 0
Instrument S/W Revision: Prior to A.02.00

Recall Instrument State

This command recalls the instrument state from the specified instrument memory register.

- If the state being loaded has a newer firmware revision than the revision of the instrument, no state is recalled and an error is reported.
- If the state being loaded has an equal firmware revision than the revision of the instrument, the state will be loaded.
- If the state being loaded has an older firmware revision than the revision of the instrument, the instrument will only load the parts of the state that apply to the older revision.

Remote Command: *RCL <register #>
Example: *RCL 7 Recalls the instrument state that is currently stored in register 7.
Restriction and Notes: Registers 0 through 6 are accessible from the front panel in menu keys for Recall Registers.
SCPI Status Bits/OPC
Dependencies: The command is sequential.
Min: 0
Max: 127
Help Map ID: 0
Instrument S/W Revision: Prior to A.02.00

Save Instrument State

This command saves the current instrument state and mode to the specified instrument memory register.

Remote Command: *SAV <register #>
Example: *SAV 9 Saves the instrument state in register 9.
Restriction and Notes: Registers 0 through 6 are accessible from the front panel in menu keys for Save Registers.
SCPI Status Bits/OPC
Dependencies: The command is sequential.

Min: 0
 Max: 127
 Help Map ID: 0
 Instrument S/W Revision: Prior to A.02.00

Service Request Enable

This command enables the desired bits of the service request enable register.
 The query returns the value of the register, indicating which bits are currently enabled.

Remote Command: *SRE <integer>
 *SRE?

Example: *SRE 22 Enables bits 1, 2, and 4 in the service request enable register.

Remote Command Notes: For related commands, see the STATus subsystem and SYSTem:ERRor[:NEXT]? commands.

Preset: 0

SCPI Status Bits/OPC Dependencies: Service Request Enable Register (all bits, 0 – 7).

Min: 0
 Max: 255
 Help Map ID: 0
 Instrument S/W Revision: Prior to A.02.00

Status Byte Query

Returns the value of the status byte register without erasing its contents.

Remote Command: *STB?

Example: *STB? Returns a decimal value for the bits in the status byte register.
 For example, if a 16 is returned, it indicates that bit 5 is set and one of the conditions monitored in the standard event status register is set.

Remote Command Notes: See related command *CLS.

SCPI Status Bits/OPC Dependencies: Status Byte Register (all bits, 0 – 7).

Help Map ID: 0
 Instrument S/W Revision: Prior to A.02.00

Trigger

This command triggers the instrument. Use the :TRIGger[:SEQuence]:SOURce command to select the trigger source.

Key Path	No equivalent key. See related keys Single and Restart.
Remote Command	*TRG
Example	*TRG Triggers the instrument to take a sweep or start a measurement, depending on the current instrument settings.
Remote Command Notes	See related command :INITiate:IMMediate.
Help Map ID	0
Instrument S/W Revision	Prior to A.02.00

Self Test Query

This query performs the internal self-test routines and returns a number indicating the success of the testing. A zero is returned if the test is successful, 1 if it fails.

Remote Command:	*TST?
Example:	*TST? Runs the self-test routines and returns 0=passed, 1=some part failed.
Help Map ID:	0
Instrument S/W Revision:	Prior to A.02.00

Wait-to-Continue

This command causes the instrument to wait until all overlapped commands are completed before executing any additional commands. There is no query form for the command.

Remote Command:	*WAI
Example:	INIT:CONT OFF; INIT:*WAI Sets the instrument to single sweep. Starts a sweep and waits for its completion.
SCPI Status Bits/OPC Dependencies:	Not global to all remote ports or front panel. *OPC only considers operation that was initiated on the same port as the *OPC command was issued from.
Help Map ID:	0
Instrument S/W Revision:	Prior to A.02.00

File

Opens a menu of keys which access various standard and custom Windows dialogs. Pressing any other front-panel key exits any of these dialogs.

Instrument S/W Revision Prior to A.02.00

File Explorer

Opens the standard Windows File Explorer. Pressing any front-panel key closes the Explorer application. File Explorer opens up in My Documents.

Instrument S/W Revision Prior to A.02.00

Page Setup

Refer to your Microsoft Windows Operating System manual.

Instrument S/W Revision Prior to A.02.00

Print Theme – Remote Command

The graphical user interface contains a selection for choosing the Theme to use when printing. An equivalent remote command is provided. Refer to the View/Display section for more detail on Themes.

Mode	All
Remote Command	:SYSTem:PRINT:THEME TDCoLor TDMonochrome FCoLoR FMONochrome :SYSTem:PRINT:THEME?
Example	:SYST:PRIN:THEM FCOL
Preset	FCOL; not part of Preset, but is reset by Restore Misc Defaults or Restore System Defaults All and survives subsequent running of the modes
State Saved	No
Instrument S/W Revision	Prior to A.02.00

Print

Refer to your Microsoft Windows Operating System manual.

Exit

This key, when pressed, will exit the Instrument Application. A dialog box will be used to confirm that

you intended to exit the application:

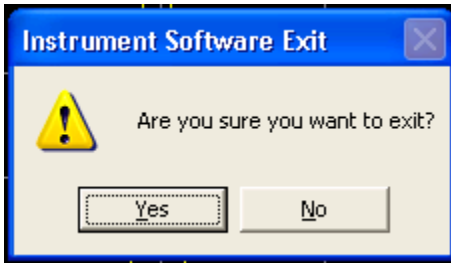

Key Path	File, Exit
Mode	All
Remote Command Notes	The Instrument Application will be closed. No further SCPI commands can be sent after this command. Use with caution!
Instrument S/W Revision	Prior to A.02.00

Preset

Mode Preset

The Mode preset is the most common way to get the active mode back to a known state. It will keep you in the currently active mode and reset the mode settings to their mode preset state. It will never cause a mode switch. It does a partial preset. It does not affect any mode persistent settings or any system settings.

The **Mode Preset** does the following for the currently active mode:

- Aborts the currently running measurement.
- Brings up the default menu for the mode, with no active function.
- Sets Measurement settings to their preset values for the active mode only.
- Activates the default measurement.
- Brings up the default menu for the mode.
- Clears the input and output buffers.
- Sets Status Byte to 0.

Key Path	Front-panel key
Remote Command	:SYSTem:PRESet
Example	:SYST:PRES
Remote Command Notes	*RST is preferred over :SYST:PRES for remote operation. *RST does a Mode Preset as done by the :SYST:PRES command and it sets the measurement mode to Single measurement rather than Continuous for optimal remote control throughput.
Restriction and Notes	Clears all pending OPC bits. The Status Byte is set to 0.
Dependencies/Couplings	A Mode Preset will cause the currently running measurement to be aborted and cause the default measurement to be active. Mode Preset gets the mode to a consistent state with all of the default couplings set.
Instrument S/W Revision	Prior to A.02.00

How-To Preset

The table below shows all possible presets, their corresponding SCPI commands and front panel access (Key Path). Instrument settings depend on the current measurement context. Some settings are local to the current measurement, some are global (common) across all the measurement in the current mode, and some are global to all the available modes. In a similar way, restoring the settings to their preset state can be done within the different contexts.

The Auto Couple front-panel key is a Meas local key. It sets all Auto/Man parameter couplings in the measurement to Auto. Any Auto/Man selection that is local to the other measurements in the mode will

not be affected by Auto Couple.

The Meas Preset key is a Meas local key. Meas Preset resets all the variables local to the current measurement except the persistent ones.

The Mode Preset (front-panel key on front panel) resets all the current mode's Meas local and Meas global variables except the persistent ones.

The Restore Mode Defaults key resets ALL the Mode variables (and all the Meas global and Meas local variables), including the persistent ones.

Type Of Preset	SCPI Command	Front Panel Access
Auto Couple	:COUPle ALL	Auto Couple front-panel key
Meas Preset	:CONFigure:<Measurement>	Meas Setup Menu
Mode Preset	:SYSTem:PRESet	Mode Preset (green key)
Restore Mode Defaults	:INSTrument:DEFault	Mode Setup Menu
Restore All Mode Defaults	:SYSTem:DEFault MODEs	System Menu; Restore System Default Menu
*RST	*RST	not possible (Mode Preset with Single)
Restore Input/Output Defaults	:SYSTem:DEFault INPut	System Menu; Restore System Default Menu
Restore Power On Defaults	:SYSTem:DEFault PON	System Menu; Restore System Default Menu
Restore Alignment Defaults	:SYSTem:DEFault ALIGn	System Menu; Restore System Default Menu
Restore Miscellaneous Defaults	:SYSTem:DEFault MISC	System Menu; Restore System Default Menu
Restore All System Defaults	:SYSTem:DEFault [ALL] :SYSTem:PRESet:PERsistent	System Menu; Restore System Default Menu
User Preset	:SYSTem:PRESet:USER	User Preset Menu
User Preset All Modes	:SYSTem:PRESet:USER:ALL	User Preset Menu
Power On Mode Preset	:SYSTem:PON:TYPE MODE	System Menu
Power On User Preset	:SYSTem:PON:TYPE USER	System Menu
Power On Last State	:SYSTem:PON:TYPE LAST	System Menu

Restore Mode Defaults

Restore Mode Defaults resets the state for the currently active mode by resetting the mode persistent settings to their factory default values, clearing mode data and by performing a Mode Preset. This function will never cause a mode switch. This function performs a full preset for the currently active

System Functions

Preset

mode; whereas, Mode Preset performs a partial preset. Restore Mode Defaults does not affect any system settings. System settings are reset by Restore System Defaults. This function does reset mode data; as well as settings.

Key Path	Mode Setup
Remote Command	:INSTrument:DEFault
Example	:INST:DEF
Remote Command Notes	Clears all pending OPC bits. The Status Byte is set to 0.
Restriction and Notes	A pop-up message comes up saying: "If you are sure, press key again".
Dependencies/Couplings	A Restore Mode Defaults will cause the currently running measurement to be aborted and causes the default measurement to be active. It gets the mode to a consistent state with all of the default couplings set.
Instrument S/W Revision	Prior to A.02.00

***RST (Remote Command Only)**

*RST is equivalent to :SYST:PRES:INIT:CONT OFF which is a Mode Preset in Single measurement state. This remote command is preferred over Mode Preset remote command - :SYST:PRES, as optimal remote programming occurs with the instrument in single measurement state.

Remote Command:	*RST
Example:	*RST
Remote Command Notes:	Sequential
Restriction and Notes:	Clears all pending OPC bits and the Status Byte is set to 0.
Dependencies/Couplings:	A *RST will cause the currently running measurement to be aborted and cause the default measurement to be active. *RST gets the mode to a consistent state with all of the default couplings set.
Instrument S/W Revision:	Prior to A.02.00

Print

The Print front-panel key is equivalent to performing a File, Print, OK. It immediately performs the currently configured Print to the current printer.

Key Path	Front-panel key
Instrument S/W Revision	Prior to A.02.00

Quick Save

The Quick Save front-panel key repeats the most recent save which was performed from the Save menu, with some qualification:

Quick Save pays no attention to register saves. Register saves are not remembered as Saves for the purpose of Quick Save

If the current measurement does not support the last non-register save that was performed, an informational message is generated, “File type not supported for this measurement”

Quick Save repeats the last type of qualified save (that is, a save qualified by the above criteria) in the last save directory by creating a unique filename using the Auto File Naming algorithm described below.

If Quick Save is pressed after startup and before any qualified Save has been performed, the Quick Save performs a Screen Image save using the current settings for Screen Image saves (current theme, current directory), which then becomes the “last save” for the purpose of subsequent Quick Saves.

The Auto File Naming feature automatically generates a file name for use when saving a file. The filename consists of a prefix and suffix separated by a dot, as is standard for the Windows® file system. For details on the suffix for each file type, see the documentation for the Save front-panel key. A default prefix exists for each of the available file types:

Type	Default Prefix	Menu
State	State_	(Save/Recall)
Trace + State	State_	(Save/Recall)
Screen	Screen_	(Save/Recall)
Amplitude Corrections	Ampcor_	(Import/Export)
Traces	Trace_	(Import/Export)
Limit Lines	LLine_	(Import/Export)
Measurement Result	MeasR_	(Import/Export)
Capture Buffer	CapBuf_	(Import/Export)

A four digit number is appended to the prefix to create a unique file name. The numbering sequence starts at 0000 within each Mode for each file type and works its way up to 9999, then wraps to 0000 again. It remembers where it was through a Mode Preset and when leaving and returning to the Mode. It is reset by Restore Misc Defaults and Restore System Defaults and subsequent running of the instrument application. So, for example, the first auto file name generated for State files is State_0000.state. The next is State_0001, and so forth.

One of the key features of Auto File Name is that we guarantee that the Auto File Name will never conflict with an existing file. This is because the whole point of Auto File Name is to relieve you from having to pick a file name. The algorithm looks for the next available number. If it gets to 9999, then it looks for holes. If it find no holes; i.e. no more numbers are available, it gives an error.

For example, if when we get to State_0010.state there is already a State_0010.state file in the current

directory, we advance the counter to State_0011.state to ensure that no conflict will exist (and then we verify that State_0011.state also doesn't exist in the current directory and advance again if it does, et cetera).

If you enter a file name for a given file type, then the prefix becomes the filename you entered instead of the default prefix, followed by an underscore. The last four letters (the suffix) are the 4-digit number.

For example, if you save a Meas Results file as "fred.csv", then the next auto file name chosen for a Meas Results save will be fred_0000.csv.

NOTE Although 0000 is used in the example above, the number that is used is actually the current number in the Meas Results sequence, that is, the number that would have been used if you had not entered their own file name.

NOTE If the filename you entered ends with _dddd, where d=any number, making it look just like an auto file name, then the next auto file name picks up where you left off with the suffix being dddd + 1.

Key Path	Quick Save
Remote Command Notes	No remote command for this key specifically.
Instrument S/W Revision	Prior to A.02.00

Recall

Operation of this key is identical across several measurements. For details about this key, see [“Recall” on page 1179](#).

Save

Operation of this key is identical across several measurements. For details about this key, see [“Save” on page 1203](#).

System

Opens a menu of keys that access various configuration menus and dialogs.

Key Path	Front-panel key
Remote Command Notes	No remote command for this key specifically.
Instrument S/W Revision	Prior to A.02.00

Show

Opens a menu of choices that enable you to select the information window you want to view.

Key Path	System
Mode	All
Remote Command	:SYSTem:SHOW OFF ERRor SYSTem HARDware LXI HWSTatistics ALIGNment SOFTware :SYSTem:SHOW?
Example	:SYST:SHOW SYST
Remote Command Notes	This command displays (or exits) the various System information screens.
Preset	OFF
State Saved	No
Range	OFF ERRor SYSTem HARDware LXI HWSTatistics ALIGNment SOFTware
Instrument S/W Revision	Prior to A.02.00

Errors

There are two modes for the Errors selection, History and Status.

The list of errors displayed in the Errors screen does not automatically refresh; you must press the Refresh button or leave the screen and return to it to refresh it.

History brings up a screen displaying the event log in chronological order, with the newest event at the top. The history queue can hold up to 100 messages (if a message has a repeat count greater than 1 it only counts once against this number of 100). Note that this count bears no relation to the size of the SCPI queue. If the queue extends onto a second page, a scroll bar appears to allow scrolling with a mouse. Time is displayed to the second.

Status brings up a screen summarizing the status conditions currently in effect. Note that the time is displayed to the second.

The fields on the Errors display are:

Type (unlabeled) - Displays the icon identifying the event or condition as an error or warning.

ID - Displays the error number.

Message - Displays the message text.

Repeat (RPT) - This field shows the number of consecutive instances of the event, uninterrupted by other events. In other words, if an event occurs 5 times with no other intervening event, the value of repeat will be 5.

If the value of Repeat is 1 the field does not display. If the value of Repeat is >1, the time and date shown are those of the most recent occurrence. If the value of repeat reaches 999,999 it stops there.

Time - Shows the most recent time (including the date) at which the event occurred.

Key Path	System, Show
Mode	All
Remote Command	:SYSTem:ERRor[:NEXT]?
Example	:SYST:ERR?
Restriction and Notes	The return string has the format: “<Error Number>,<Error>” Where <Error Number> and <Error> are defined in the Master Error Messages document.
State Saved	No
Instrument S/W Revision	Prior to A.02.00

Next Page Next Page and Previous Page menu keys move you between pages of the log, if it fills more than one page. These keys are grayed out in some cases:

If on the last page of the log, the Next Page key is grayed out

If on the first page of the log, the Previous Page key is grayed out.

If there is only one page, both keys are grayed out.

Key Path	System, Show, Errors
Instrument S/W Revision	Prior to A.02.00

Previous Page See “Next Page” on page 205.

Key Path	System, Show, Errors
Instrument S/W Revision	Prior to A.02.00

History The History and Status keys select the Errors view. The Status key has a second line which

System Functions System

shows a number in [square brackets]. This is the number of currently open status items.

Key Path	System, Show, Errors
Instrument S/W Revision	Prior to A.02.00

Status See “History” on page 205.

Verbose SCPI On/Off This is a capability that will allow the SCPI data stream to be displayed when a SCPI error is detected, showing the characters which stimulated the error and several of the characters preceding the error.

Key Path	System, Show, Errors
Mode	All
Remote Command	:SYSTem:ERRor:VERBoSe OFF ON 0 1 :SYSTem:ERRor:VERBoSe?
Example	:SYST:ERR:VERB ON
Preset	This is unaffected by Preset but is set to OFF on a “Restore System Defaults->Misc”
State Saved	No
Range	On Off
Instrument S/W Revision	Prior to A.02.00

Refresh When pressed, refreshes the Show Errors display.

Key Path	System, Show, Errors
Instrument S/W Revision	Prior to A.02.00

Clear Error Queue This clears all errors in all error queues.

Clear Error Queue does not affect the current status conditions.

Mode Preset does not clear the error queue.

Restore System Defaults will clear all error queues.

*CLS only clears the queue if it is sent remotely and *RST does not affect any error queue.

Switching modes does not affect any error queues.

Key Path	System, Show, Errors
Instrument S/W Revision	Prior to A.02.00

System

The System screen is formatted into three groupings: product descriptive information, options tied to the

hardware, and software products:

```

<Product Name> <Product Description>
Product Number: N9020A
Serial Number: US46220924
Firmware Revision: A.01.01
Computer Name: <hostname>
Host ID: N9020A,US44220924

N9020A-503      Frequency Range to 3.6 GHz
N9020A-PFR      Precision Frequency Reference
N9020A-P03      Preamp 3.6 GHz

N9060A-2FP      Spectrum Analysis Measurement Suite  1.0.0.0
N9073A-1FP      WCDMA 1.0.0.0
N9073A-2FP      WCDMA with HSDPA 1.0.0.0
  
```

The Previous Page is unavailable if the first page of information is presently displayed. The Next Page menu key is unavailable if the last page is information is presently displayed.

Key Path	System, Show
Mode	All
Example	SYST:SHOW SYST
Instrument S/W Revision	Prior to A.02.00

Hardware

The show hardware screen is used to view details of the installed hardware. This information can be used to determine versions of hardware assemblies and field programmable devices, in the advent of future upgrades or potential repair needs.

The screen is formatted into two groupings: product descriptive information and hardware information. The hardware information is listed in a table format:

Instrument S/W Revision Prior to A.02.00

LXI Event Log The event log records all of the LXI LAN event activity. As LXI LAN events are sent or received, the activity is noted in the Event Log with an IEEE 1588 timestamp. When the event log is selected, the current contents of the event log are displayed in the system information screen.

The fields recorded in the Event Log are:

- The date the event occurred (GMT)
- The time the event occurred (GMT)
- The type of event: LAN Input, LAN Output, Status, Alarm, Trigger Alarm, Trigger LAN
- The name of the event
- The edge associated with the event
- The event’s identifier: This is the string that appears on the LAN.
- The source event: This is only valid for LAN Output, Trigger LAN, and Trigger Alarm event types.
- The source address: This is only valid for LAN Input event types. It is the address from which the message originated.
- The destination address: This is only valid for LAN Output event types. It is the address (or addresses) that the message will be sent to. For UDP messages, this field reads “ALL.”

Key Path **System, Show, LXI**

Instrument S/W Revision Prior to A.02.00

Next Page See [“Next Page” on page 205](#)

Key Path **System, Show, Errors**

Instrument S/W Revision Prior to A.02.00

Previous Page See [“Next Page” on page 205](#).

Key Path **System, Show, Errors**

Instrument S/W Revision Prior to A.02.00

Circular Sets the behavior for entries that occur while the LXI Event Log is full.

- If Circular is set to 1, incoming events overwrite the oldest events in the log.
- If Circular is set to 0, incoming events are discarded.
-

Key Path **System, Show, LXI, LXI Event Log**

System Functions

System

Remote Command	:LXI:EVENT:LOG:CIRCular[:ENABLE] ON OFF 1 0 :LXI:EVENT:LOG:CIRCular[:ENABLE]?
Example	:LXI:EVEN:LOG:CIRC 1
Preset	Not affected by a Preset. The default value of "ON" can be restored by pressing System, Restore Defaults, Misc.
State Saved	Saved in instrument state.
Range	OFF ON 0 1
Instrument S/W Revision	Prior to A.02.00

Clear Clears the event log of all entries.

Key Path	System, Show, LXI, LXI Event Log
Remote Command	:LXI:EVENT:LOG:CLEar
Example	:LXI:EVEN:LOG:CLE
Instrument S/W Revision	Prior to A.02.00

Size Sets the maximum number of entries the LXI Event Log can hold.

Key Path	System, Show, LXI, LXI Event Log
Remote Command	:LXI:EVENT:LOG:SIZE <size> :LXI:EVENT:LOG:SIZE?
Example	:LXI:EVEN:LOG:SIZE 256
Preset	Not affected by a Preset. The default value of "64" can be restored by pressing System, Restore Defaults, Misc.
State Saved	Saved in instrument state.
Range	>= 0
Instrument S/W Revision	Prior to A.02.00

Enabled Enables and disables the logging of LXI Events.

Key Path	System, Show, LXI, LXI Event Log
Remote Command	:LXI:EVENT:LOG:ENABLE ON OFF 1 0 :LXI:EVENT:LOG:ENABLE?
Example	:LXI:EVEN:LOG:ENAB ON
Preset	Not affected by a Preset. The default value of "ON" can be restored by pressing System, Restore Defaults, Misc.
State Saved	Saved in instrument state.

Range ON|OFF|0|1
Instrument S/W Revision Prior to A.02.00

Count (Remote Only) Returns the number of entries currently in the LXI Event Log.

Remote Command: :LXI:EVENT:LOG:COUNT?
Example: :LXI:EVEN:LOG:COUN?
Range: 0 – Size
Instrument S/W Revision: Prior to A.02.00

Next Entry (Remote Only) Returns the oldest entry from the LXI Event Log and removes it from the log. If the log is empty, an empty string is returned.

Remote Command: :LXI:EVENT:LOG[:NEXT]?
Example: :LXI:EVEN:LOG?
Instrument S/W Revision: Prior to A.02.00

All (Remote Only) Non-destructively retrieves the entire contents of the event log. Entries are returned as separate strings, surrounded by double quote marks, and separated by a comma. Fields within each entry are also comma delimited.

Remote Command: :LXI:EVENT:LOG:ALL?
Example: :LXI:EVEN:LOG:ALL? Returns the entire event log contents.
An example may look like the following:
"11/12/2007,18:14:10.770385,Error,LogOverwrite,Rise,,," , "11/12/2007,18:14:10.592105,Status,Measuring,Rise,,," , "11/12/2007,18:14:10.597758,Status,Measuring,Fall,,," , "11/12/2007,18:14:10.597786,Status,Sweeping,Fall,,," , "11/12/2007,18:14:10.599030,Status,WaitingForTrigger,Rise,,,"
The contents of the Event Log vary, based on the operation of the instrument.
Instrument S/W Revision: Prior to A.02.00

Specific Entry (Remote Only) Non-destructively retrieves a specifically indexed entry from the event log. Fields within an entry are comma delimited.

Remote Command: :LXI:EVENT:LOG:ENTRY? <intIndex>
Example: :LXI:EVEN:LOG:ENTR? 0 Returns the first entry in the event log.
An example may look like the following:
"11/12/2007,18:14:10.770385,Error,LogOverwrite,Rise,,,"
The contents of the Event Log vary, based on the operation of the instrument.
Instrument S/W Revision: Prior to A.02.00

System Functions

System

Beginning Entry (Remote Only) Sets or freezes the beginning entry of the log when in circular mode to the most recently added entry at the time of the command. This is so that the :LXI:EVENT:LOG:ENTry? command has a reference entry for indexing individual entries in the log.

Remote Command: :LXI:EVENT:LOG:CIRCular:FBENtry

Example: :LXI:EVENT:LOG:CIRC:FBEN

Instrument S/W Revision: Prior to A.02.00

Power On

The Power On menu key enables you to select how the instrument should power on. The options are: Mode and Input/Output Defaults, User Preset and Last State.

Key Path	System
Mode	All
Remote Command	:SYSTem:PON:TYPE MODE USER LAST PRESet :SYSTem:PON:TYPE?
Example	:SYST:PON:TYPE MODE
Preset	This is unaffected by Preset but is set to Mode on a “Restore System Defaults->All”
State Saved	No
Instrument S/W Revision	Prior to A.02.00

Mode and Input/Output Defaults

When the analyzer is powered on in Mode and Input/Output Defaults, it will perform a Restore Mode Defaults to all modes in the instrument and a Restore Input/Output Defaults as well.

Key Path	System, Power On
Mode	All
Example	SYST:PON:TYPE MODE
Instrument S/W Revision	Prior to A.02.00

User Preset

Sets **Power On** to **User Preset**. When the analyzer is powered on in User Preset, it will User Preset each mode and switch to the power-on mode. Power On User Preset will not affect any settings beyond what a normal User Preset affects.

NOTE An instrument could never power up for the first time in User Preset.

Key Path	System, Power On
Mode	All
Example	SYST:PON:TYPE USER
Instrument S/W Revision	Prior to A.02.00

Last State

Sets **Power On** to **Last**. When the analyzer is powered on, it will put all modes in the last state they were in prior to when the analyzer was put into Power Standby and it will wake up in the mode it was last in prior to powering off the instrument. The saving of the active mode prior to shutdown happens behind the scenes when a controlled shutdown is requested by using the front panel power **Standby** key or by using the remote command `SYSTem:PDOWn`. The non-active modes are saved as they are deactivated and recalled by Power On Last State.

NOTE An instrument could never power up for the first time in Last.

If line power to the analyzer is interrupted, for example by pulling the line cord plug or by switching off power to a test rack, Power On Last State will not work properly.

Key Path	System, Power On
Mode	All
Example	SYST:PON:TYPE LAST
Restriction and Notes	Power on Last State only works if you have done a controlled shutdown prior to powering on in Last. If a controlled shutdown is not done when in Power On Last State, the instrument will power up in the last active mode, but it may not power up in the active mode's last state. If an invalid mode state is detected, a Mode Preset will occur. To control the shutdown under remote control use the <code>:SYSTem:PDOWn</code> command.
Instrument S/W Revision	Prior to A.02.00

Power On Application

This menu key brings up a Mode Menu that lists the available modes and lets you select which Mode is to be the power-on mode.

This application is used for Power On Type "Mode and Input/Output Defaults" and Restore System Defaults All.

Key Path	System, Power On
----------	-------------------------

System Functions

System

Mode	All
Remote Command	:SYSTem:PON:MODE SA BASIC ADEMOD NFIGURE PNOISE CDMA2K TDSCDMA VSA VSA89 601 WCDMA WIMAXOFDMA :SYSTem:PON:MODE?
Example	SYST:PON:MODE SA
Restriction and Notes	The list of possible modes (and remote parameters) to choose from is dependent on which modes are installed in the instrument.
Preset	This is unaffected by Preset but is set on a “Restore System Defaults->All” to SA unless Spectrum Analysis mode is not installed in the instrument in which case the factory will load the default power-on mode.
State Saved	No
Instrument S/W Revision	Prior to A.02.00

Configure Applications

The Configure Application utility allows you configure the bootup for fastest first mode switch time or faster boot time. In addition, there are more applications available for the X-Series than can fit into Windows® Virtual Memory. The Configure Application utility allows you to choose which licensed applications to load in-memory. There will be multiple opportunities for you to perform the configuration.

The Configure Applications utility will provide a graphical representation of the amount of Virtual Memory consumed. The indicator will be green when <90% of the memory limit is consumed, yellow for memory consumption is 90% to 100%, and red when consumption is >100% of the limit.

Key Path	System, Power On
Instrument S/W Revision	A.02.00

Configure Applications - Next application startup

Select All Select All marks all applications in the selection list. This allows you to enable all applications licensed on the instrument for pre-loading, or is a convenience for selecting all applications in one operation and then letting you deselect individual applications.

Key Path	System, Power On, Configure Applications
Instrument S/W Revision	A.02.00

Deselect All Deselect All removes marks from all applications in the selection list, with the exception of the Power On application (the Power On application cannot be eliminated from the pre-load list). This allows you to disable all applications licensed on the instrument for pre-loading (with the exception of the Power On application), or is a convenience for deselecting all applications in one operation and then

select individual applications.

Key Path	System, Power On, Configure Applications
Instrument S/W Revision	A.02.00

Move Up The application list is the order in which applications appear in the Mode Menu. Move Up shifts the selected application up in the list, thus moving the selected application earlier in the Mode Menu.

Key Path	System, Power On, Configure Applications
Instrument S/W Revision	A.02.00

Move Down The application list is the order in which applications appear in the Mode Menu. Move Down shifts the selected application down in the list, thus moving the selected application later in the Mode Menu.

Key Path	System, Power On, Configure Applications
Instrument S/W Revision	A.02.00

Select/Deselect Toggles the currently highlighted application in the list.

Key Path	System, Power On, Configure Applications
Instrument S/W Revision	A.02.00

Save Changes Applies the configuration of applications list: marked application will be pre-loaded in memory the next time the instrument application is started, and the order of applications in the list will be the order of applications in the Mode Menu.

Key Path	System, Power On, Configure Applications
Notes	The menu key will be unavailable when the virtual memory of the selected applications exceeds 100% of the limit.
Instrument S/W Revision	A.02.00

System Restart System Restart provides a means to restart the instrument application. Upon restart the applications in the pre-load list will be loaded in memory.

Key Path	System, Power On, Configure Applications
Remote Command	:SYSTem:PUP:PROcEss
Example	:SYST:PUP:PROC Must Wait after this command for the instrument application to restart

Notes You cannot use *WAI or *OPC? to synchronize operation; this command stops and restarts the instrument application, thus the SCPI operation is terminated and restarted. A remote program must use fixed wait time to resume sending commands to the instrument. The wait time will be dependent upon which applications are pre-loaded.

Instrument S/W Revision A.02.00

Configure Applications - Remote commands

Configuration list (Remote command only) This remote command is used to set or query the list of applications to be loaded in-memory.

Remote Command: :SYSTem:PON:APPLication:LLISt <string of INSTRument:SELEct names>
:SYSTem:PON:APPLication:LLISt?

Example: :SYST:PON:APPL:LLIS "SA,BASIC,WCDMA"

Notes: <string of INSTRument:SELEct names> are from the enums of the :INSTRument:SELEct command in Meas Common section 13.3
The order of the <INSTRument:SELEct names> is the order in which the applications are loaded into memory, and the order in which they appear in the Mode Menu.

Error -225 "Out of Memory" is reported when more applications are listed than can reside in Virtual Memory. In such circumstance the existing applications load list is unchanged.

Preset: Not affected by Preset

State Saved: Not saved in state

Instrument S/W Revision: A.02.00

Configuration Memory Available (Remote command only) This remote command is used to query the amount of Virtual Memory remaining.

Remote Command: :SYSTem:PON:APPLication:VMEMory[:AVAIlable]?

Example: :SYST:PON:APPL:VMEM?

Preset: Not affected by Preset

Instrument S/W Revision: A.02.00

Configuration Memory Total (Remote command only) This remote command is used to query the limit of Virtual Memory allowed for applications.

Remote Command: :SYSTem:PON:APPLication:VMEMory:TOTAL?

Example: :SYST:PON:APPL:VMEM:TOT?

Preset: Not affected by Preset
Instrument S/W Revision: A.02.00

Configuration Memory Used (Remote command only) This remote command is a query of the amount of Virtual Memory used by all measurement applications.

Remote Command: :SYSTem:PON:APPLication:VMEMory:USED?
Example: :SYST:PON:APPL:VMEM:USED?
Preset: Not affected by Preset
Instrument S/W Revision: A.02.00

Configuration Application Memory (Remote command only) This remote command is used to query the amount of Virtual Memory a particular application consumes.

Remote Command: :SYSTem:PON:APPLication:VMEMory:USED:NAME?
<INSTRument:SElect name>
Example: :SYST:PON:APPL:VMEM:USED:NAME? CDMA2K
Notes: <INSTRument:SElect name> is from the enums of the :INSTRument:SElect command in Meas Common section 13.3
Value returned will be 0 (zero) if the name provided is invalid.
Preset: Not affected by Preset
Instrument S/W Revision: A.01.70 or later

Restore Power On Defaults

This selection causes the Power On Type and Power On Application settings to be a reset to their default value. This level of Restore System Defaults does not affect any other system settings, mode settings and does not cause a mode switch. The Power On menu key under the Restore System Defaults menu causes the same action.

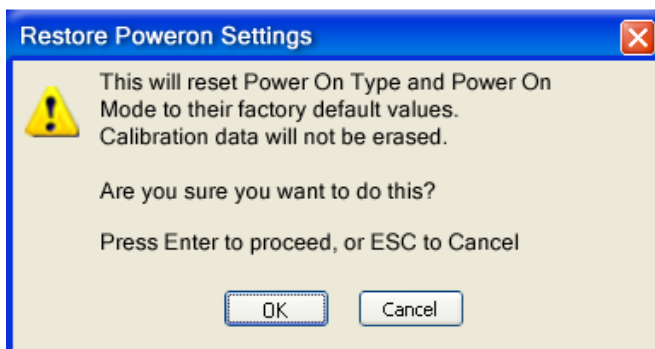

If you press any key other than OK or Enter, it is construed as a Cancel, because the only path that will

actually cause the reset to be executed is through OK or Enter.

Key Path	System, Power On
Example	:SYST:DEF PON
Instrument S/W Revision	Prior to A.02.00

Alignments

The Alignments Menu controls and displays the automatic alignment of the instrument, and provides the ability to restore the default alignment values.

The current setting of the alignment system is displayed in the system Settings Panel along the top of the display, including a warning icon for conditions that may cause specs to be impacted, for example:



Key Path	System
Instrument S/W Revision	Prior to A.02.00

Auto Align

Configures the method for which the automatic background alignment is run.

Automatic background alignments are run periodically between measurement acquisitions. The instrument's software determines when alignments are to be performed to maintain warranted operation. The recommended setting for **Auto Align** is **Normal**.

An Auto Align execution cannot be aborted with the Cancel (ESC) key. To interrupt an Auto Align execution, select **Auto Align Off**.

Key Path	System, Alignments
Mode	All
Remote Command	:CALibration:AUTO ON PARTial OFF ALERT :CALibration:AUTO?
Example	:CAL:AUTO ON
Restriction and Notes	While Auto Align is executing, bit 0 of Status Operation register is set.
Preset	This is unaffected by Preset but is set to ON upon a "Restore System Defaults->Align".
SCPI Status Bits/OPC Dependencies	When Auto Align is executing, bit 0 in the Status Operational register is set.
Dependencies/Couplings	Auto Align is set to Off if Restore Align Data is invoked.
State Saved	No
Instrument S/W Revision	Prior to A.02.00

Normal Auto Align, Normal turns on the automatic alignment of all measurement systems. **Auto Align, Normal** maintains the instrument in warranted operation across varying temperature and over time.

If the condition “Align Now, All required” is set, transition to **Auto Align, Normal** will perform the required alignments and clear the “Align Now, All required” condition and then continue with further alignments as required to maintain the instrument adequately aligned for warranted operation.

When **Auto Align, Normal** is selected the Auto Align Off time is set to zero.

When **Auto Align, Normal** is selected the Settings Panel indicates ALIGN AUTO.

Key Path	System, Alignments, Auto Align
Mode	All
Example	:CAL:AUTO ON
Restriction and Notes	<p>Alignment processing as a result of the transition to Normal will be executed sequentially. Thus, *OPC? or *WAI following CAL:AUTO ON will return when the alignment processing is complete.</p> <p>The presence of an external signal may interfere with the RF portion of the alignment. If so, the Error Condition “Align skipped: 50 MHz interference” or “Align skipped: 4.8 GHz interference” is reported, and bit 11 is set in the Status Questionable Calibration register. After the interfering signal is removed, subsequent alignment of the RF will clear the condition, and clear bit 11 in the Status Questionable Calibration register.</p>
SCPI Status Bits/OPC Dependencies	<p>An interfering user signal may prevent automatic alignment of the RF subsystem. If this occurs, the Error Condition “Align skipped: 50 MHz interference” or “Align skipped: 4.8 GHz interference” is reported, the Status Questionable Calibration bit 11 is set, and the alignment proceeds. When a subsequent alignment of the RF subsystem succeeds, either by the next cycle of automatic alignment or from an Align Now, RF, the Error Condition and Status Questionable Calibration bit 11 are cleared.</p>
Instrument S/W Revision	Prior to A.02.00

Partial Auto Align, Partial disables the full automatic alignment and the maintenance of warranted operation for the benefit of improved measurement throughput. Accuracy is retained for the Resolution Bandwidth filters and the IF Passband which is critical to FFT accuracy, demodulation, and many measurement applications. With Auto Align set to **Partial**, you are now responsible for maintaining warranted operation by updating the alignments when they expire. The **Auto Align, Alert** mechanism will notify you when alignments have expired. One solution to expired alignments is to perform the **Align All, Now** operation. Another is to return the **Auto Align** selection to **Normal**.

Auto Align, Partial is recommended for measurements where the throughput is so important that a few percent of improvement is more valued than an increase in the accuracy errors of a few tenths of a decibel. One good application of **Auto Align, Partial** would be an automated environment where the alignments can be called during overhead time when the device-under-test is exchanged.

When **Auto Align, Partial** is selected the elapsed time counter begins for Auto Align Off time.

When **Auto Align, Partial** is selected the Settings Panel indicates ALIGN PARTIAL with a warning

System Functions System

icon. The warning icon is to inform the operator that they are responsible for maintaining the warranted operation of the instrument

Key Path	System, Alignments, Auto Align
Mode	All
Example	:CAL:AUTO PART
Restriction and Notes	Auto Align Partial begins the elapsed time counter for Auto Align Off time.
Instrument S/W Revision	Prior to A.02.00

Off Auto Align, Off disables automatic alignment and the maintenance of warranted operation, for the benefit of maximum measurement throughput. With Auto Align set to **Off**, you are now responsible for maintaining warranted operation by updating the alignments when they expire. The **Auto Align, Alert** mechanism will notify you when alignments have expired. One solution to expired alignments is to perform the **Align All, Now** operation. Another is to return the **Auto Align** selection to **Normal**.

The **Auto Align, Off** setting is rarely the best choice, because **Partial** gives almost the same improvement in throughput while maintaining the warranted performance for a much longer time. The **Off** choice is intended for unusual circumstances such as the measurement of radar pulses where you might like the revisit time to be as consistent as possible.

When **Auto Align, Off** is selected the Auto Align Off time is initialized and the elapsed time counter begins.

When **Auto Align, Off** is selected the Settings Panel indicates ALIGN OFF with a warning icon. The warning icon is to inform the operator that they are responsible for maintaining the warranted operation of the instrument:

Key Path	System, Alignments, Auto Align
Mode	All
Example	:CAL:AUTO OFF
Restriction and Notes	Auto Align Off begins the elapsed time counter for Auto Align Off time.
Dependencies/Couplings	Auto Align is set to Off if Restore Align Data is invoked.
Instrument S/W Revision	Prior to A.02.00

All but RF Auto Align, All but RF, configures automatic alignment to include or exclude the RF subsystem. (Eliminating the automatic alignment of the RF subsystem prevents the input impedance from changing. The normal input impedance of 50 ohms can change to an open circuit when alignments are being used. Some devices under test do not behave acceptably under such circumstances, for example by showing instability.) When **Auto Align, All but RF ON** is selected, the operator is responsible for performing an **Align Now, RF** when RF-related alignments expire. The **Auto Align, Alert** mechanism will notify the operator to perform an **Align Now, All** when the combination of time and temperature variation is exceeded.

When **Auto Align, All but RF ON** is selected the Settings Panel indicates ALIGN AUTO/NO RF with a warning icon (warning icon is intended to inform the operator they are responsible for the maintaining

the RF alignment of the instrument):

Key Path	System, Alignments, Auto Align
Mode	All
Remote Command	:CALibration:AUTO:MODE ALL NRF :CALibration:AUTO:MODE?
Example	:CAL:AUTO:MODE NRF
Preset	This is unaffected by Preset but is set to ALL on a “Restore System Defaults->Align”.
State Saved	No
Instrument S/W Revision	Prior to A.02.00

Alert The instrument will signal an Alert when conditions exist such that you will need to perform a full alignment (for example, **Align Now, All**). The Alert can be configured in one of four settings; **Time & Temperature, 24 hours, 7 days**, or **None**. A confirmation is required when a selection other than **Time & Temperature** is chosen. This prevents accidental deactivation of alerts.

With **Auto Align** set to **Normal**, the configuration of **Alert** is not relevant because the instrument’s software maintains the instrument in warranted operation.

Key Path	System, Alignments, Auto Align
Mode	All
Remote Command	:CALibration:AUTO:ALERT TTEMPerature DAY WEEK NONE :CALibration:AUTO:ALERT?
Example	:CAL:AUTO:ALER TTEM
Remote Command Notes	The alert that alignment is needed is the setting of bit 14 in the Status Questionable Calibration register.
Preset	This is unaffected by Preset but is set to TTEMPerature on a “Restore System Defaults->Align”.
SCPI Status Bits/OPC Dependencies	The alert is the Error Condition “Align Now, All required” and bit 14 is set in the Status Questionable Calibration register.
State Saved	No
Instrument S/W Revision	Prior to A.02.00

Time & Temperature With Auto Align Alert set to **Time & Temperature** the instrument will signal an alert when alignments expire due to the combination of the passage of time and changes in temperature. The alert is the Error Condition “Align Now, All required”. If this choice for Alert is selected, the absence of an alert means that the analyzer alignment is sufficiently up-to-date to maintain warranted accuracy.

Key Path	System, Alignments, Auto Align, Alert
----------	--

System Functions System

Mode	All
Example	:CAL:AUTO:ALERT
SCPI Status Bits/OPC Dependencies	Bit 14 is set in the Status Questionable Calibration register.
Instrument S/W Revision	Prior to A.02.00

24 hours With Auto Align Alert set to **24 Hours** the instrument will signal an alert after a time span of 24 hours since the last successful full alignment (for example, **Align Now, All** or completion of a full Auto Align). You may choose this selection in an environment where the temperature is stable on a daily basis at a small risk of accuracy errors in excess of the warranted specifications. The alert is the Error Condition “Align Now, All required”.

For front panel operation, confirmation is required to transition into this setting of Alert. The confirmation dialog is:

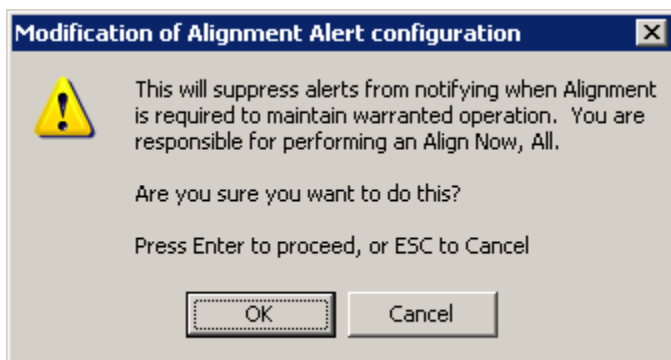

No confirmation is required when Alert is configured through a remote command.

Key Path	System, Alignments, Auto Align, Alert
Mode	All
Example	:CAL:AUTO:ALERT DAY
SCPI Status Bits/OPC Dependencies	Bit 14 is set in the Status Questionable Calibration register.
Instrument S/W Revision	Prior to A.02.00

7 days With Auto Align Alert is set to **7 days** the instrument will signal an alert after a time span of 168 hours since the last successful full alignment (for example, **Align Now, All** or completion of a full Auto Align). You may choose this selection in an environment where the temperature is stable on a weekly basis, at a modest risk of accuracy degradations in excess of warranted performance. The alert is the Error Condition “Align Now, All required”.

For front panel operation, confirmation is required for the customer to transition into this setting of Alert. The confirmation dialog is:

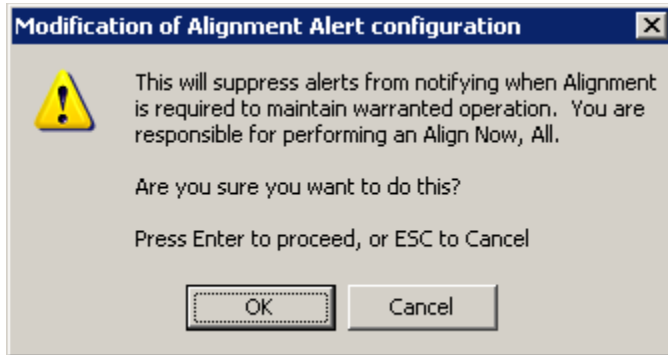

No confirmation is required when Alert is configured through a remote command.

Key Path	System, Alignments, Auto Align, Alert
Mode	All
Example	:CAL:AUTO:ALER WEEK
SCPI Status Bits/OPC Dependencies	Bit 14 is set in the Status Questionable Calibration register.
Instrument S/W Revision	Prior to A.02.00

None With Auto Align Alert set to **None** the instrument will not signal an alert. This is provided for rare occasions where you are making a long measurement which cannot tolerate Auto Align interruptions, and must have the ability to capture a screen image at the end of the measurement without an alert posted to the display. Agilent does not recommends using this selection in any other circumstances, because of the risk of accuracy performance drifting well beyond expected levels without the operator being informed.

For front panel operation, confirmation is required to transition into this setting of Alert. The confirmation dialog is:

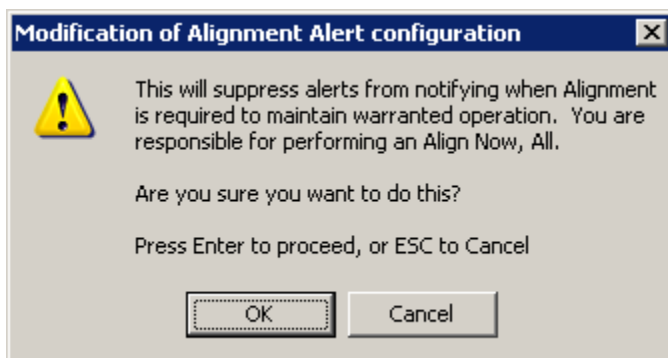

No confirmation is required when Alert is configured through a remote command.

Key Path	System, Alignments, Auto Align, Alert
Mode	All
Example	:CAL:AUTO:ALER NONE

Example	:CAL
Remote Command Notes	:CALibration[:ALL]? returns 0 if successful :CALibration[:ALL]? returns 1 if failed :CALibration[:ALL]? is the same as *CAL? While Align Now, All is performing the alignment, bit 0 in the Status Operation register is set. Completion, or termination, will clear bit 0 in the Status Operation register. This command is sequential; it must complete before further SCPI commands are processed. Interrupting the alignment from remote is accomplished by invoking Device Clear followed by the :ABORT command. Successful completion will clear bit 14 in the Status Questionable Calibration register. An interfering user signal is not grounds for failure of Align Now, All. However, bits 11 and 12 are set in the Status Questionable Calibration register to indicate Align Now, RF is required.
Restriction and Notes	An interfering user supplied signal will result in the instrument requiring an Align Now, RF with the interfering signal removed.
SCPI Status Bits/OPC Dependencies	Bits 11, 12, or 14 may be set in the Status Questionable Calibration register.
Dependencies/Couplings	Initializes the time for the Last Align Now, All Time. Records the temperature for the Last Align Now, All Temperature. If Align RF component succeeded, initializes the time for the Last Align Now, RF Time. If Align RF component succeeded, records the temperature for the Last Align Now, RF Temperature.
Instrument S/W Revision	Prior to A.02.00
Mode	All
Remote Command	*CAL?
Example	*CAL?
Remote Command Notes	*CAL? returns 0 if successful *CAL? returns 1 if failed :CALibration[:ALL]? is the same as *CAL? See additional remarks described with :CALibration[:ALL]?
Restriction and Notes	Everything about :CALibration[:ALL]? is synonymous with *CAL? including all conditions, status register bits, and couplings
Instrument S/W Revision	Prior to A.02.00

All but RF Immediately executes an alignment of all subsystems except the RF subsystem. The

System Functions System

instrument will stop any measurement currently underway, perform the alignment, and then restart the measurement from the beginning (similar to pressing the **Restart** key). This can be used to align portions of the instrument that are not impacted by an interfering user input signal.

This operation might be chosen instead of **All** if you do not want the device under test to experience a large change in input impedance, such as a temporary open circuit at the analyzer input.

The query form of the remote commands (:CALibration:NRF?) will invoke the alignment and return a success or failure value.

Successful completion of **Align Now, All but RF** will clear the “Align Now, All required” Error Condition, and clear bit 14 in the Status Questionable Calibration register. If “Align Now, All required” was in effect prior to executing the All but RF, the Error Condition “Align Now, RF required” is asserted and bit 12 in the Status Questionable Calibration register is set. It will also begin the elapsed time counter for Last Align Now, All Time, and capture the Last Align Now, All Temperature.

Align Now, All but RF can be interrupted by pressing the Cancel (ESC) front-panel key or remotely with Device Clear followed by the :ABORt SCPI command. When this occurs the Error Condition “Align Now, All required” is set, and bit 14 is set in the Status Questionable Condition register. This is because new alignment data may be used for an individual subsystem, but not a full new set of data for all subsystems.

Key Path	System, Alignments, Align Now
Mode	All
Remote Command	:CALibration:NRF :CALibration:NRF?
Example	:CAL:NRF
Remote Command Notes	:CALibration:NRF? returns 0 if successful :CALibration:NRF? returns 1 if failed While Align Now, All but RF is performing the alignment, bit 0 in the Status Operation register is set. Completion, or termination, will clear bit 0 in the Status Operation register. This command is sequential; it must complete before further SCPI commands are processed. Interrupting the alignment from remote is accomplished by invoking Device Clear followed by the :ABORt command. Successful completion will clear bit 14 in the Status Questionable Calibration register and set bit 12 if invoked with “Align Now, All required”.
SCPI Status Bits/OPC Dependencies	Bits 12 or 14 may be set in the Status Questionable Calibration register.
Dependencies/Couplings	Initializes the time for the Last Align Now, All Time. Records the temperature for the Last Align Now, All Temperature.
Instrument S/W Revision	Prior to A.02.00

RF Immediately executes an alignment of the RF subsystem. The instrument stops any measurement currently underway, performs the alignment, then restarts the measurement from the beginning (similar

to pressing the **Restart** key).

This operation might be desirable if the alignments had been set to not include RF alignments, or if previous RF alignments could not complete because of interference which has since been removed.

If an interfering user signal is present at the RF Input, the alignment will terminate and raise the Error Condition “Align skipped: 50 MHz interference” or “Align skipped: 4.8 GHz interference”, and Error Condition “Align Now, RF required”. In addition, bits 11 and 12 will be set in the Status Questionable Calibration register.

The query form of the remote commands (:CALibration:RF?) will invoke the alignment of the RF subsystem and return a success or failure value. An interfering user signal is grounds for failure.

A failure encountered during alignment will set the Error Condition “Align RF failed” and set bit 3 in the Status Questionable Calibration register.

Successful completion of **Align Now, RF** clears the Error Conditions “Align skipped: 50 MHz interference” and “Align skipped: 4800 MHz interference” and the Error Conditions “Align RF failed” and “Align Now, RF required”, and clears bits 3, 11, and 12 in the Status Questionable Calibration register. It will also begin the elapsed time counter for Last Align Now, RF Time, and capture the Last Align Now, RF Temperature.

Align Now, RF can be interrupted by pressing the Cancel (ESC) front-panel key or remotely with Device Clear followed by the :ABORt SCPI command. When this occurs, the Error Condition “Align Now, RF required” is set, and bit 12 is set in the Status Questionable Condition register. None of the new alignment data is used.

Key Path	System, Alignments, Align Now
Mode	All
Remote Command	:CALibration:RF :CALibration:RF?
Example	:CAL:RF
Remote Command Notes	:CALibration:RF? returns 0 if successful :CALibration:RF? returns 1 if failed (including interfering user signal) While Align Now, RF is performing the alignment, bit 0 in the Status Operation register is set. Completion, or termination, will clear bit 0 in the Status Operation register. This command is sequential; it must complete before further SCPI commands are processed. Interrupting the alignment from remote is accomplished by invoking Device Clear followed by the :ABORt command. Successful completion will clear bits 3, 11, and 12 in the Status Questionable Calibration register. A failure encountered during alignment will set the Error Condition “Align RF failed” and set bit 3 in the Status Questionable Calibration register. An interfering user signal will result in bits 11 and 12 to be set in the Status Questionable Calibration register to indicate Align Now, RF is required.

System Functions System

Restriction and Notes	An interfering user supplied signal will result in the instrument requiring an Align Now, RF with the interfering signal removed.
SCPI Status Bits/OPC Dependencies	Bits 11, 12, or 14 may be set in the Status Questionable Calibration register.
Dependencies/Couplings	Initializes the time for the Last Align Now, RF Time. Records the temperature for the Last Align Now, RF Temperature.
Instrument S/W Revision	Prior to A.02.00

Advanced

Advanced accesses alignment processes that are immediate action operations that perform operations that run until complete. Advanced alignments are performed on an irregular basis, or require additional operator interaction

Key Path	System, Alignments
Instrument S/W Revision	Prior to A.02.00

Characterize Preselector (Only with Option 507, 508, 513, or 526) The Preselector tuning curve drifts over temperature and time. Recognize that the **Amplitude, Presel Center** function adjusts the preselector for accurate amplitude measurements at an individual frequency. **Characterize Preselector** improves the amplitude accuracy by ensuring the Preselector is approximately centered at all frequencies without the use of the **Amplitude, Presel Center** function. **Characterize Preselector** can be useful in situations where absolute amplitude accuracy is not of utmost importance, and the throughput savings or convenience of not performing a **Presel Center** is desired. **Presel Center** is required prior to any measurement for best (and warranted) amplitude accuracy.

Agilent recommends that the **Characterize Preselector** operation be performed yearly as part of any calibration, but performing this operation every three months can be worthwhile.

Characterize Preselector immediately executes a characterization of the Preselector, which is a YIG-tuned filter (YTF). The instrument stops any measurement currently underway, performs the characterization, then restarts the measurement from the beginning (similar to pressing the **Restart** key).

The query form of the remote commands (:CALibration:YTF?) will invoke the alignment of the YTF subsystem and return a success or failure value.

A failure encountered during alignment will set the Error Condition “Characterize YTF failed” and set bit 9 in the Status Questionable Calibration register.

Successful completion of **Advanced, Characterize Preselector** will clear the Error Condition “Characterize YTF failed”, and clear bit 9 in the Status Questionable Calibration register. It will also begin the elapsed time counter for Last Characterize Preselector Time, and capture the Last Characterize Preselector Temperature.

The last Characterize Preselector Time and Temperature must survive across the power cycle as this operation is performed infrequently.

Advanced, Characterize Preselector can be interrupted by pressing the Cancel (ESC) front-panel key or remotely with Device Clear followed by the :ABORt SCPI command. None of the new

characterization data is then used.

Key Path	System, Alignments, Align Now
Mode	All
Remote Command	:CALibration:YTF :CALibration:YTF?
Example	:CAL:YTF
Remote Command Notes	:CALibration:YTF? returns 0 if successful :CALibration:YTF? returns 1 if failed (including interfering user signal) While Advanced, Characterize Preselector is performing the alignment, bit 0 in the Status Operation register is set. Completion, or termination, will clear bit 0 in the Status Operation register. This command is sequential; it must complete before further SCPI commands are processed. Interrupting the alignment from remote is accomplished by invoking Device Clear followed by the :ABORt command. Successful completion will clear bit 9 in the Status Questionable Calibration register. A failure encountered during alignment will set the Error Condition “Characterize Preselector failed” and set bit 9 in the Status Questionable Calibration register. For Option 507, 508, 513, and 526 only.
Dependencies/Couplings	Initializes the time for the Last Characterize Preselector Time. Records the temperature for the Last Characterize Preselector Temperature.
Instrument S/W Revision	Prior to A.02.00

Show Alignment Statistics

Shows alignment information you can use to ensure that the instrument is operating in a specific manner. The Show Alignment Statistics screen is where you can view time and temperature information.

Values which are displayed are only updated when the Show Alignment Statistics screen is invoked, they are not updated while the Show Alignment Statistics screen is being displayed. The remote commands which access this information obtain current values.

An example of the Show Alignment Statistics screen would be similar to:

System Functions System

Std Header	Product Number: N9020A Serial Number: US46340924 Firmware Revision: A.01.01	
Instrument Info	Time since start-up: 300 hrs Current Temperature: +28 degC	Times & Temperature delta. Shown as "---" if none since start-up.
Auto Align Info	Time while Auto Align off: 90 min	
Std Align Now	Time since last Align Now All: 12.5 hrs Temperature since last Align Now All: -1.3 degC Time since last Align Now RF: 5 min Temperature since last Align Now RF: +0.1 degC	
If TG Option (Not Zorro1)	Time since last Align TG: 2.5 hrs Temperature since last Align TG: +0.2 degC	
Opts 508,513 526	Last Characterize Preselector: Jun 1, 2006 15:00:00 Last Characterize Preselector Temperature: +32.1 degC	Time & Temperature 'stamp'

A successful Align Now, RF will set the Last Align RF temperature to the current temperature, and reset the Last Align RF time. A successful Align Now, All or Align Now, All but RF will set the Last Align Now All temperature to the current temperature, and reset the Last Align Now All time. A successful Align Now, All will also reset the Last Align RF items if the RF portion of the Align Now succeeded.

Key Path	System, Alignments
Mode	All
Restriction and Notes	The values displayed on the screen are only updated upon entry to the screen and not updated while the screen is being displayed.
Instrument S/W Revision	Prior to A.02.00
Key Path	Visual annotation in the Show Alignment Statistics screen
Mode	All
Remote Command	:SYSTem:PON:TIME?
Example	:SYST:PON:TIME?
Restriction and Notes	Value is the time since the most recent start-up in seconds.
State Saved	No
Instrument S/W Revision	Prior to A.02.00
Key Path	Visual annotation in the Show Alignment Statistics screen
Mode	All
Remote Command	:CALibration:TEMPerature:CURRENT?

Example	:CAL:TEMP:CURR?
Restriction and Notes	Value is in degrees Centigrade. Value is invalid if using default alignment data (Align Now, All required)
State Saved	No
Instrument S/W Revision	Prior to A.02.00
Key Path	Visual annotation in the Show Alignment Statistics screen
Mode	All
Remote Command	:CALibration:TIME:LALL?
Example	:CAL:TIME:LALL?
Restriction and Notes	Value is the elapsed time, in seconds, since the last successful Align Now, All or Align Now, All but RF was executed.
State Saved	No
Instrument S/W Revision	Prior to A.02.00
Key Path	Visual annotation in the Show Alignment Statistics screen
Mode	All
Remote Command	:CALibration:TEMPerature:LALL?
Example	:CAL:TEMP:LALL?
Restriction and Notes	Value is in degrees Centigrade at which the last successful Align Now, All or Align Now, All but RF was executed.
State Saved	No
Instrument S/W Revision	Prior to A.02.00
Key Path	Visual annotation in the Show Alignment Statistics screen
Mode	All
Remote Command	:CALibration:TIME:LRF?
Example	:CAL:TIME:LRF?
Restriction and Notes	Value is the elapsed time, in seconds, since the last successful Align Now, RF was executed, either individually or as a component of Align Now, All.
State Saved	No
Instrument S/W Revision	Prior to A.02.00
Key Path	Visual annotation in the Show Alignment Statistics screen

System Functions System

Mode	All
Remote Command	:CALibration:TEMPerature:LRF?
Example	:CAL:TEMP:LRF?
Restriction and Notes	Value is in degrees Centigrade at which the last successful Align Now, RF was executed, either individually or as a component of Align Now, All.
State Saved	No
Instrument S/W Revision	Prior to A.02.00
Key Path	Visual annotation in the Show Alignment Statistics screen
Mode	All
Remote Command	:CALibration:TIME:LPreselector?
Example	:CAL:TIME:LPR?
Restriction and Notes	Value is date and time the last successful Characterize Preselector was executed. The date is separated from the time by a space character. Returns "" if no Characterize Preselector has ever been performed on the instrument.
State Saved	No
Instrument S/W Revision	Prior to A.02.00
Key Path	Visual annotation in the Show Alignment Statistics screen
Mode	All
Remote Command	:CALibration:TEMPerature:LPreselector?
Example	:CAL:TEMP:LPR?
Restriction and Notes	Value is in degrees Centigrade at which the last successful Characterize Preselector was executed.
State Saved	No
Instrument S/W Revision	Prior to A.02.00
Key Path	Visual annotation in the Show Alignment Statistics screen
Mode	All
Remote Command	:CALibration:AUTO:TIME:OFF?
Example	:CAL:AUTO:TIME:OFF?
Restriction and Notes	Value is the elapsed time, in seconds, since Auto Align has been set to Off or Off with Alert. The value is 0 if Auto Align is ALL or NORF.
State Saved	No
Instrument S/W Revision	Prior to A.02.00

Timebase DAC

Allows control of the internal 10 MHz reference oscillator timebase. This may be used to adjust for minor frequency alignment between the signal and the internal frequency reference. This adjustment has no effect if the instrument is operating with an External Frequency Reference.

If the value of the Timebase DAC changes (by switching to Calibrated from User with User set to a different value, or in User with a new value entered) an alignment may be necessary. The alignment system will take appropriate action; which will either invoke an alignment or cause an Alert.

Key Path	System, Alignments
Mode	All
Remote Command	:CALibration:FREQuency:REFerence:MODE CALibrated USER :CALibration:FREQuency:REFerence:MODE?
Example	:CAL:FREQ:REF:MODE CAL
Remote Command Notes	If the value of the timebase is changed the alignment system automatically performs an alignment or alerts that an alignment is due.
Restriction and Notes	If the value of the timebase is changed the alignment system automatically performs an alignment or alerts that an alignment is due.
Preset	This is unaffected by Preset but is set to CALibrated on a “Restore System Defaults->Align”.
State Saved	No
Instrument S/W Revision	Prior to A.02.00

Calibrated Sets the Timebase DAC to the value established during factory or field calibration. The value displayed on the menu key is the calibrated value.

Key Path	System, Alignments, Timebase DAC
Mode	All
Example	:CAL:FREQ:REF:MODE CAL
Instrument S/W Revision	Prior to A.02.00

User Allows setting the Timebase DAC to a value other than the value established during the factory or field calibration. The value displayed on the menu key is the calibrated value.

Key Path	System, Alignments, Timebase DAC
Mode	All
Example	:CAL:FREQ:REF:MODE USER
Instrument S/W Revision	Prior to A.02.00

System Functions System

Key Path	System, Alignments, Timebase DAC
Mode	All
Remote Command	:CALibration:FREQuency:REFErence:FINE <integer> :CALibration:FREQuency:REFErence:FINE?
Example	:CAL:FREQ:REF:FINE 8191
Restriction and Notes	If the value of the timebase is changed the alignment system automatically performs an alignment or alerts that an alignment is due.
Preset	This is unaffected by Preset but is set to the factory setting on a “Restore System Defaults->Align”.
Dependencies/Couplings	Setting :CAL:FREQ:REF:FINE sets :CAL:FREQ:REF:MODE USER
State Saved	No
Min	0
Max	16383
Instrument S/W Revision	Prior to A.02.00
Remote Command:	:CALibration:FREQuency:REFErence:COARse <integer> :CALibration:FREQuency:REFErence:COARse?
Example:	:CAL:FREQ:REF:COAR 8191
Remote Command Notes:	This is an alias for CAL:FREQ:REF:FINE any change to COARse is reflected in FINE and vice-versa. See CAL:FREQ:REF:FINE for description of functionality.
Dependencies/Couplings:	Setting :CAL:FREQ:REF:COAR sets :CAL:FREQ:REF:MODE USER
Instrument S/W Revision:	Prior to A.02.00

Restore Align Defaults

Initializes the alignment user interface settings, not alignment data, to the factory default values. Align Now, All must be executed if the value of the Timebase DAC results in a change.

For front panel operation, you are prompted to confirm action before setting the alignment parameters to factory defaults:

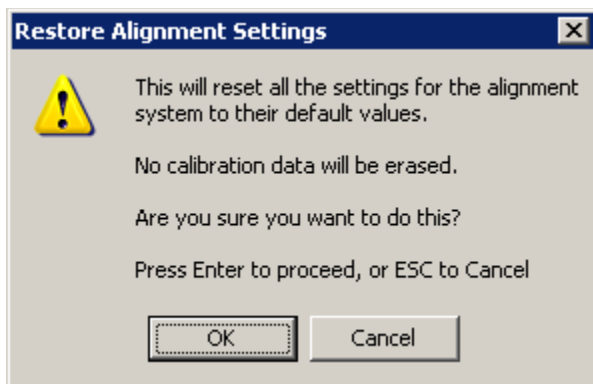

The parameters affected are:

Parameter	Setting
Timebase DAC	Calibrated
Timebase DAC setting	Calibrated value
Auto Align State	Normal (if the instrument is not operating with default alignment data, Off otherwise)
Auto Align All but RF	Off
Auto Align Alert	Time & Temperature
Key Path	System, Alignments
Mode	All
Example	:SYST:DEF ALIG
Restriction and Notes	Alignment processing that results as the transition to Auto Alignment Normal will be executed sequentially; thus *OPC? or *WAI will wait until the alignment processing is complete.
Instrument S/W Revision	Prior to A.02.00

Backup and Restore Alignment Data

Alignment data for the instrument resides on the hard drive in a database. Agilent uses high quality hard drives; however it is highly recommended the alignment data be backed-up to storage outside of the instrument. Additionally, for customers who use multiple CPU Assemblies or multiple disk drives, the alignment that pertains to the instrument must be transferred to the resident hard drive after a CPU or hard drive is replaced. This utility facilitates backing-up and restoring the alignment data.

NOTE This utility allows the operator to navigate to any location of the Windows file system. It is intended that the operator use an USB memory device or Mapped Network Drive to backup the alignment data to storage outside of the instrument.

System Functions System

Backup or Restore Align Data... Opens the utility for backing-up or restoring the alignment data.

Key Path	System, Alignments
Instrument S/W Revision	A.02.00
Key Path	System, Alignments
Mode	All
Remote Command	:CALibration:DATA:DEFault
Example	:CAL:DATA:DEF
Dependencies/Couplings	Sets Auto Align to Off. Sets bit 14 in the Status Questionable Calibration register. The Error Condition "Align Now, All required" is set.
Instrument S/W Revision	Prior to A.02.00

Alignment Data Wizard The Backup or Restore Alignment Data wizard will guide the you through the operation of backing-up or restoring the alignment data.

The following dialogue boxes operate without a mouse or external keyboard when you use the default file names.

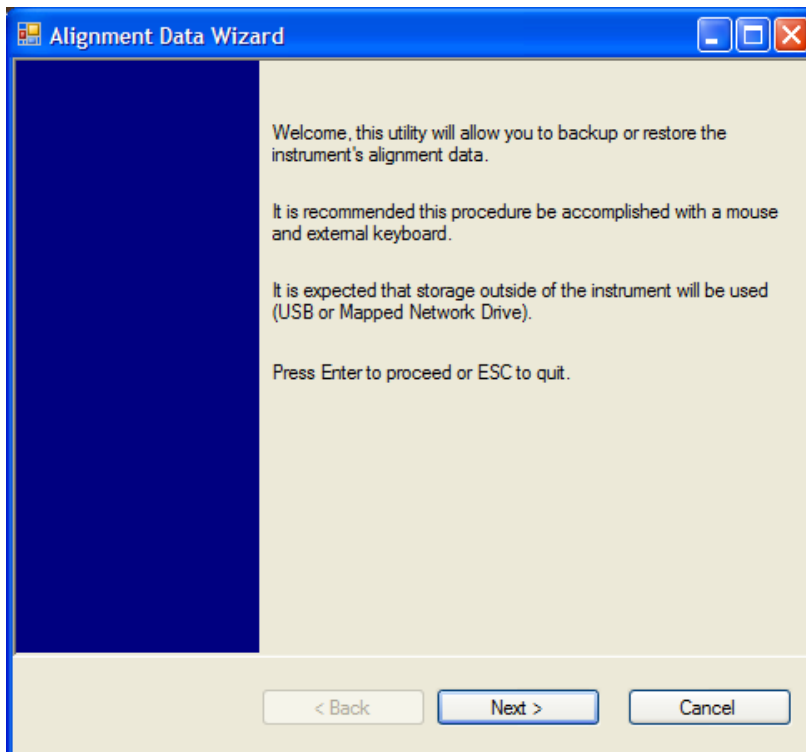

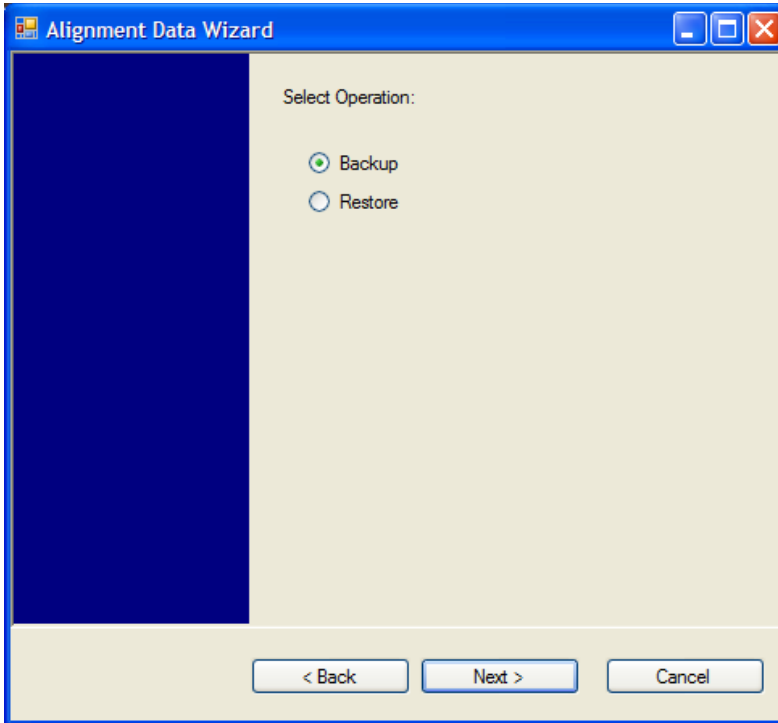

The backup screen will indicate the approximate amount of space required to contain the backup file.

The default file name will be AlignDataBackup_<model number>_<serial number>_<date in YYYYMMDDHHMMSS>.bak.

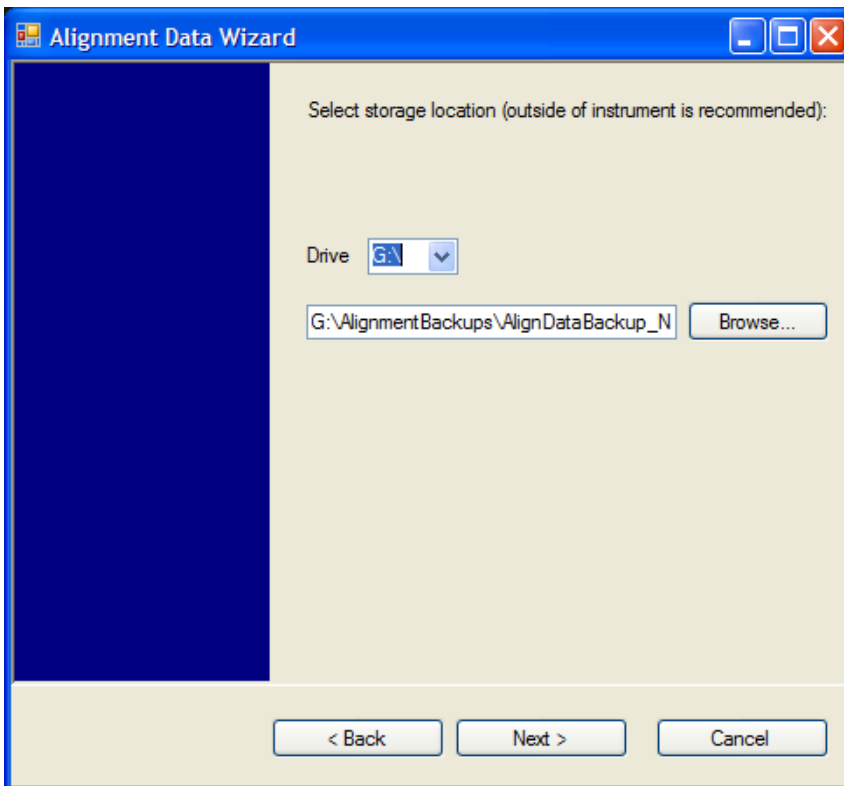

System Functions

System

Changing the drive letter will also modify the path displayed in the box below. When this step is first loaded, the drive drop-down is populated with connected drives which provide s you with write access. If there are many unreachable network drives connected to the instrument, this step can take a few seconds. If a USB drive is present, it will be selected by default. The path defaults to the AlignmentBackups folder, and a filename will be automatically created in the form of AlignDataBackup_<model>_<serial number>_<date><time>. When the "Next >" button is pressed, you will be prompted to create a new folder if the chosen path does not yet exist.

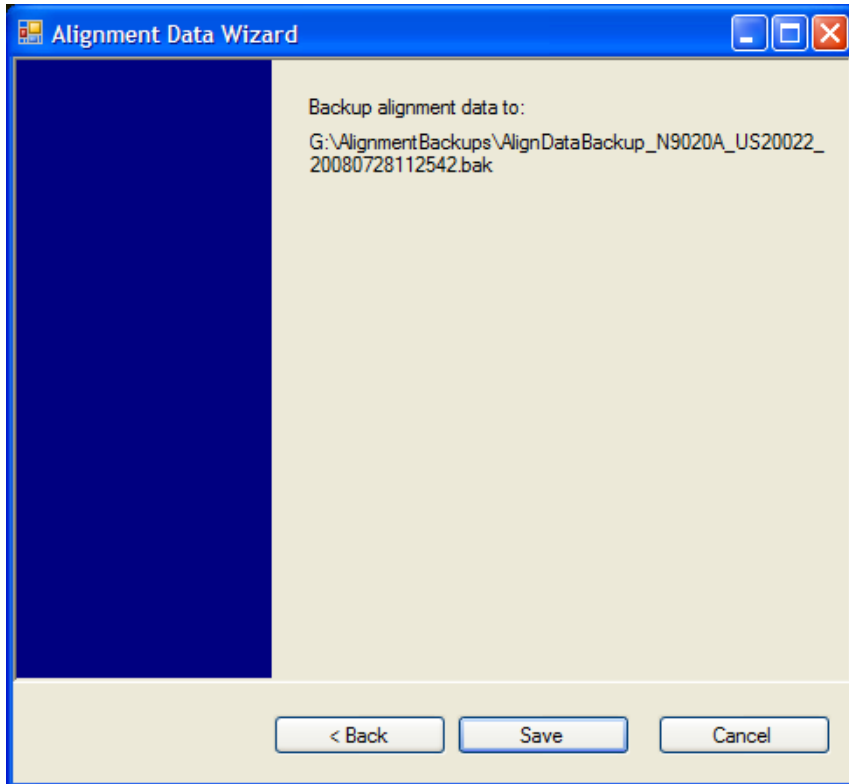

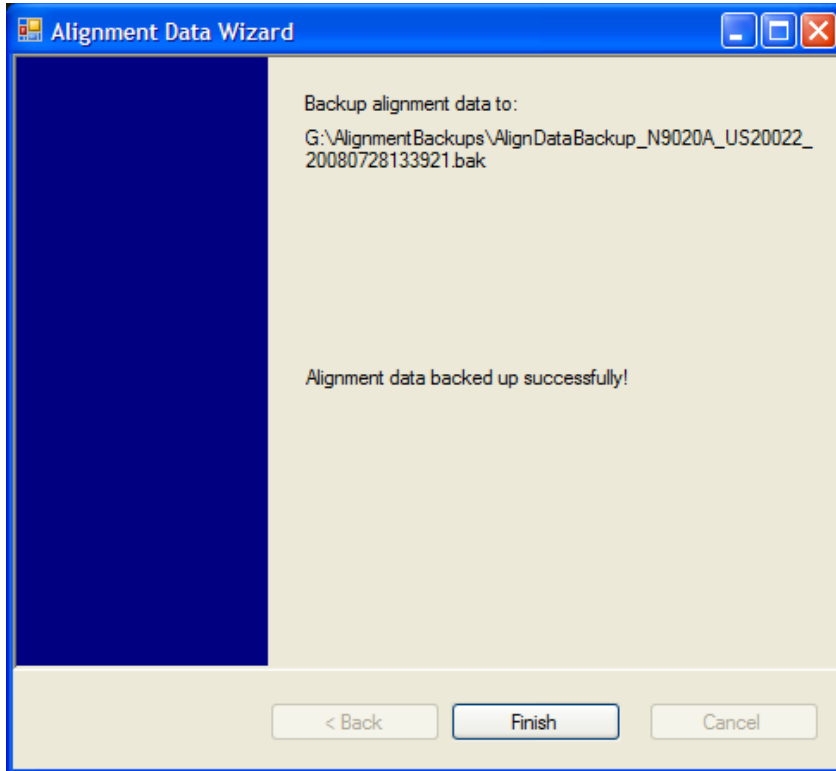

The restore operation will check the validity of the restore file using the database's built-in file validation. If the restore file is corrupt, the existing alignment data will remain in use.

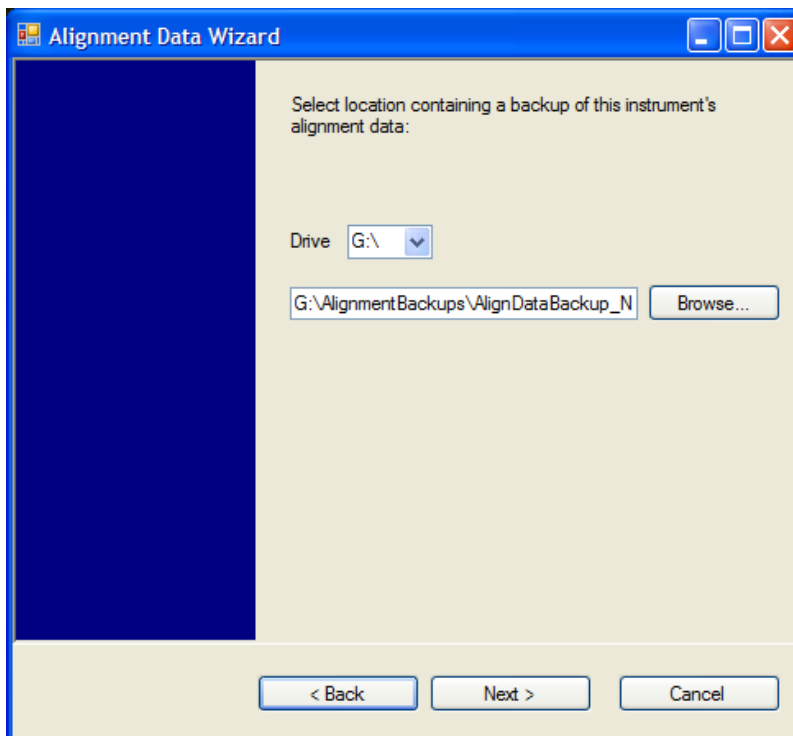

Changing the drive letter will also modify the path displayed in the box below. When this step is first loaded, the

System Functions System

drive drop-down is populated with connected drives which provide you with read access. The path defaults to the AlignBackups folder. The most recent *.bak file in the folder will also be selected by default.

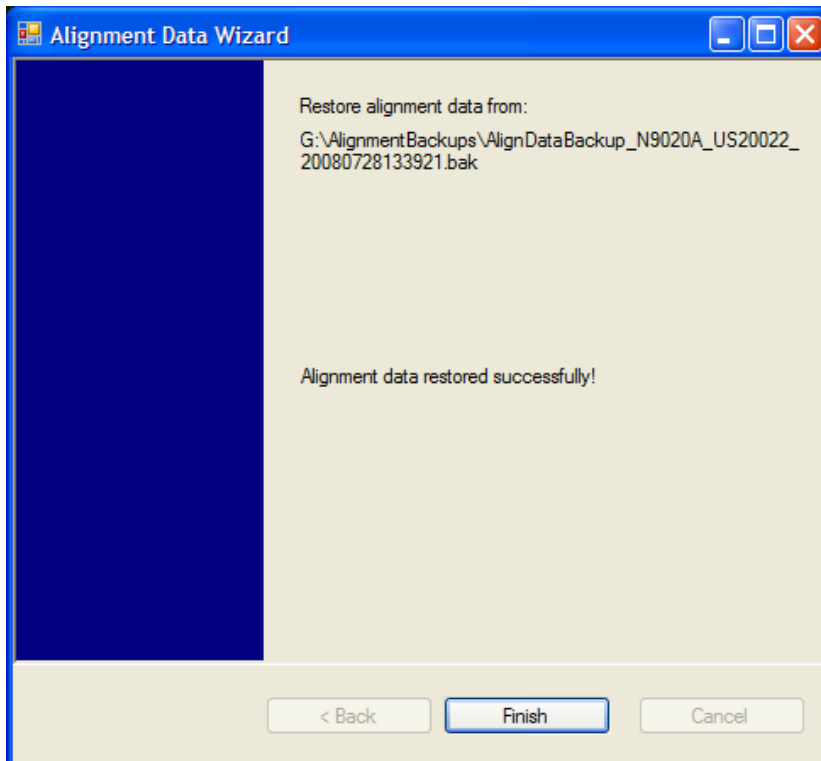
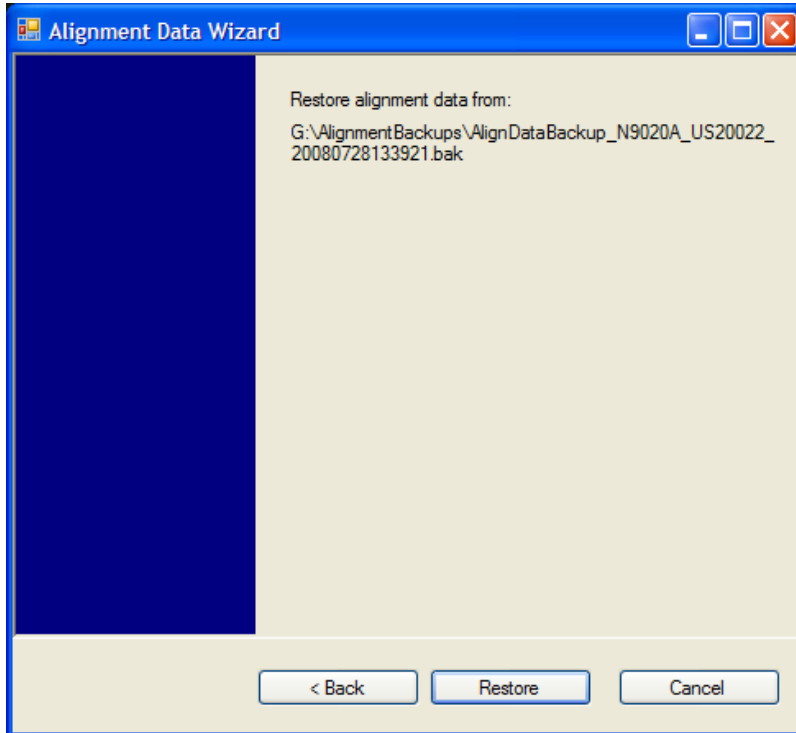

Perform Backup (Remote Command Only) Invokes an alignment data backup operation to the provided Folder.

NOTE It is recommended that the Folder provided is outside of the instrument (USB or Mapped Network Drive).

Remote Command: :CALibration:DATA:BACKup <filename>
 Example: :CAL:DATA:BACK
 "F:\AlignDataBackup_N9020A_US00000001_2008140100.bak"
 Instrument S/W Revision: A.02.00

Perform Restore (Remote Command Only) Invokes an alignment data restore operation from the provided filename.

Remote Command: :CALibration:DATA:REStore <filename>
 Example: :CAL:DATA:RESt "F:\
 AlignDataBackup_N9020A_US00000001_2008140100.bak "
 Instrument S/W Revision: A.02.00

I/O Config

Activates a menu for identifying and changing the I/O configuration for remote control.

Key Path **System**
 Instrument S/W Revision Prior to A.02.00

GPIB

Activates a menu for configuring the GPIB I/O port.

Key Path **System, I/O Config**
 Instrument S/W Revision A.02.00

GPIB Address Select the GPIB remote address.

Key Path **System, I/O Config, GPIB**
 Mode All
 Remote Command :SYSTem:COMMunicate:GPIB[1][:SELF]:ADDRess <integer>
 :SYSTem:COMMunicate:GPIB[1][:SELF]:ADDRess?
 Example :SYST:COMM:GPIB:ADDR 17
 Remote Command Notes NOTE: Changing the Address on the GPIB port requires all further communication to use the new address.

System Functions

System

Preset	This is unaffected by Preset but is set to 18 on a “Restore System Defaults->Misc”
State Saved	No
Range	0 to 30
Instrument S/W Revision	Prior to A.02.00

GPIB Controller Sets the GPIB port into controller or device mode. In the normal state, GPIB controller is disabled, which allows the analyzer to be controlled by a remote computer. When GPIB Controller is enabled, the instrument can run software applications that use the instrument's computer as a GPIB controller; controlling devices connected to the instrument's GPIB port.

NOTE When GPIB Controller is enabled, the analyzer application itself cannot be controlled over GPIB; however, in this case it can easily be controlled via LAN or USB. The GPIB port cannot be a controller and device at the same time. Additionally, only one controller can be active on the GPIB bus at any given time; if the analyzer is the controller an external PC cannot be a controller.

To control the instrument from the software that is performing GPIB controller operation, you can use an internal TCP/IP connection to the analyzer application. Use the address TCPIP0::localhost::inst0::INSTR to send SCPI commands to the analyzer application.

Remote Command	:SYSTem:COMMunicate:GPIB[1][:SELF]:CONTroller[:ENABle] ON OFF 0 1 :SYSTem:COMMunicate:GPIB[1][:SELF]:CONTroller[:ENABle]?
Example	:SYST:COMM:GPIB:CONT ON Will set GPIB port to Controller
Key Path	System, I/O Config, GPIB
Mode	All
Scope	Mode Global
Notes	When the instrument becomes the Controller bit 0 in the Standard Event Status Register is set (and when the instrument relinquishes Controller capability bit 0 is cleared in the Standard Event Status Register).
Preset	This is unaffected by Preset but is set to OFF on a “Restore System Defaults->Misc”
State Saved	No
Range	Disabled Enabled
Instrument S/W Revision	A.02.00

Disabled Selection for disabling the GPIB Controller capability, this is the default (or normal) setting.

Key Path **System, I/O Config, GPIB, GPIB Controller**

Example	:SYST:COMM:GPIB:CONT OFF	Will set GPIB port to Device
Instrument S/W Revision	A.02.00	

Enabled Selection for enabling the GPIB Controller capability.

Key Path	System, I/O Config, GPIB, GPIB Controller	
Example	:SYST:COMM:GPIB:CONT ON	Will set GPIB port to Controller
Instrument S/W Revision	A.02.00	

SCPI LAN

Activates a menu for identifying and changing the SCPI over LAN configuration. There are a number of different ways to send SCPI remote commands to the instrument over LAN. It can be a problem to have multiple users simultaneously accessing the instrument over the LAN. These keys limit that somewhat by disabling the telnet, socket, and/or SICL capability.

Key Path	System, I/O Config
Instrument S/W Revision	Prior to A.02.00

SCPI Telnet Turns the SCPI LAN telnet capability On or Off allowing you to limit SCPI access over LAN through telnet.

Key Path	System, I/O Config, SCPI LAN
Mode	All
Remote Command	:SYSTem:COMMunicate:LAN:SCPI:TELNet:ENABle OFF ON 0 1 :SYSTem:COMMunicate:LAN:SCPI:TELNet:ENABle?
Example	:SYST:COMM:LAN:SCPI:TELN:ENAB OFF
Preset	This is unaffected by Preset but is set to ON with a "Restore System Defaults->Misc"
State Saved	No
Range	On Off
Instrument S/W Revision	Prior to A.02.00

SCPI Socket Turns the capability of establishing Socket LAN sessions On or Off. This allows you to limit SCPI access over LAN through socket sessions.

Key Path	System, I/O Config, SCPI LAN
Mode	All
Remote Command	:SYSTem:COMMunicate:LAN:SCPI:SOCKet:ENABle OFF ON 0 1 :SYSTem:COMMunicate:LAN:SCPI:SOCKet:ENABle?

System Functions System

Example	:SYST:COMM:LAN:SCPI:SOCK:ENAB OFF
Preset	This is unaffected by Preset but is set to ON with a “Restore System Defaults->Misc”
State Saved	No
Range	On Off
Instrument S/W Revision	Prior to A.02.00

SCPI Socket Control Port (remote command only) Returns the TCP/IP port number of the control socket associated with the SCPI socket session. This query enables you to obtain the unique port number to open when a device clear is to be sent to the instrument. Every time a connection is made to the SCPI socket, the instrument creates a peer control socket. The port number for this socket is random. You must use this command to obtain the port number of the control socket. To force a device clear on this socket, open the port and send the string “DCL” to the instrument.

If this SCPI command is sent to a non SCPI Socket interface, then 0 is returned.

Mode	All
Remote Command	:SYSTem:COMMunicate:LAN:SCPI:SOCKet:CONTRol?
Example	:SYST:COMM:LAN:SCPI:SOCK:CONT?
Preset	This is unaffected by Preset or “Restore System Defaults->Misc”.
State Saved	No
Range	0 to 65534
Instrument S/W Revision	Prior to A.02.00

SICL Server Turns the SICL server capability On or Off, enabling you to limit SCPI access over LAN through the SICL server. (SICL IEEE 488.2 protocol.)

Parameter	Description	Setting
Maximum Connections	The maximum number of connections that can be accessed simultaneously	5
Instrument Name	The name (same as the remote SICL address) of your analyzer	inst0
Instrument Logical Unit	The unique integer assigned to your analyzer when using SICL LAN	8
Emulated GPIB Name	The name (same as the remote SICL address) of the device used when communicating with your analyzer	gpib7
Emulated GPIB Logical Unit	The unique integer assigned to your device when it is being controlled using SICL LAN	8

Emulated GPIB Address	The emulated GPIB address assigned to your transmitter tester when it is a SICL server (the same as your GPIB address)	18
Key Path	System, I/O Config, SCPI LAN	
Mode	All	
Remote Command	:SYSTem:COMMunicate:LAN:SCPI:SICL:ENABle OFF ON 0 1 :SYSTem:COMMunicate:LAN:SCPI:SICL:ENABle?	
Example	:SYST:COMM:LAN:SCPI:SICL:ENAB OFF	
Preset	This is unaffected by Preset, but is set to ON with a “Restore System Defaults->Misc”	
State Saved	No	
Range	On Off	
Instrument S/W Revision	Prior to A.02.00	

Query USB Connection (Remote Command Only)

Enables you to determine the speed of USB connection.

Mode	All	
Remote Command	:SYSTem:COMMunicate:USB:CONNecion?	
Example	:SYST:COMM:USB:CONN?	
Remote Command Notes	<p>NONE – Indicates no USB connection has been made.</p> <p>LSPeed – Indicates a USB low speed connection (1.5 Mbps). Note: this is reserved for future use, the T+M488 protocol is not supported on low speed connections.</p> <p>HSPeed – Indicates that a USB high speed connection (480 Mbps) has been negotiated.</p> <p>FSPeed – Indicates that a USB full speed connection (12 Mbps) has been negotiated.</p>	
State Saved	No	
Range	NONE LSPeed HSPeed FSPeed	
Instrument S/W Revision	Prior to A.02.00	

USB Connection Status (Remote Command Only)

Enables you to determine the current status of the USB connection.

Mode	All	
Remote Command	:SYSTem:COMMunicate:USB:STATus?	

System Functions

System

Example	:SYST:COMM:USB:STAT?
Remote Command Notes	SUSPended – Indicates that the USB bus is currently in its suspended state. The bus is in the suspended state when: The bus is not connected to any controller The controller is currently powered off The controller has explicitly placed the USB device into the suspended state. When in the suspended state, no USB activity, including start of frame packets are received. ACTive – Indicates that the USB device is in the active state. When the device is in the active state, it is receiving periodic start of frames but it isn't necessarily receiving or transmitting data.
State Saved	No
Range	SUSPended ACTive
Instrument S/W Revision	Prior to A.02.00

USB Packet Count (Remote Command Only)

Enables you to determine the number of packets received and transmitted on the USB bus.

Mode	All
Remote Command	:SYSTem:COMMunicate:USB:PACKets?
Example	:SYST:COMM:USB:PACK?
Remote Command Notes	Two integers are returned. The first is the number of packets received since application invocation, the second is the number of packets transmitted since application invocation. If no packets have been received or transmitted the response is 0,0. The packet count is initialized to 0,0 when the instrument application is started.
State Saved	No
Instrument S/W Revision	Prior to A.02.00

LXI

Pressing this key opens a menu that allows you to access the various LXI configuration properties.

Tip: For information about setting up measurements using LXI, refer to the "Programmer's Guide" located in your analyzer at: C:/Program Files/Agilent/Signal Analysis/Help/Bookfiles/x_series_prog.pdf. It is also available by selecting the "Additional Documentation" page of the Help.

Key Path	System, I/O Config
Instrument S/W Revision	Prior to A.02.00

LAN Reset This key resets the LAN connection.

Key Path	System, I/O Config, LXI
Instrument S/W Revision	Prior to A.02.00

LXI Domain The instrument only receives LXI LAN Events sent by members of the same LXI Domain. Conversely, LXI Output LAN Events sent by the instrument can only be received by members of the same LXI Domain. This is not the same as the IEEE 1588 domain (see “[Domain \(Remote Only\)](#)” on page 261 “[Domain \(Remote Only\)](#)” on page 261).

Key Path	System, I/O Config, LXI
Remote Command	:LXI:EVENT:DOMain <intDomain> :LXI:EVENT:DOMain?
Example	:LXI:EVENT:DOM 128 :LXI:EVENT:DOM?
Preset	Not affected by a Preset. The default value of "0" can be restored by pressing Restore Defs, Input/Output Settings
State Saved	Saved in instrument state.
Range	0–255
Instrument S/W Revision	Prior to A.02.00

LXI Output LAN Events The device can be configured to send LXI LAN Events as the instrument’s state changes. Specifically, it can notify other devices as the status signals WaitingForTrigger, Sweeping, Measuring, OperationComplete, and Recalling transition. Additionally, Output LAN Events can be sent in response to the receipt of any of the Input LAN Events.

This is the entry point for the LXI Output LAN Event system. This key branches to a list of events that can be sent out on the LAN in response to instrument events.

Key Path	System, I/O Config, LXI
Instrument S/W Revision	Prior to A.02.00

Disable All This command causes the Enable property of all members of the LXI Output LAN Event List to be set to OFF.

Key Path	System, I/O Config, LXI, LXI Output LAN Events
Remote Command	:LXI:EVENT[:OUTPut]:LAN:DISable:ALL
Example	:LXI:EVENT:LAN:DIS:ALL
Instrument S/W Revision	Prior to A.02.00

Output LAN Event List This is the list of LXI Output LAN events that can be sent in response to an instrument event such as sweeping or waiting for a trigger. Each member of this list has a key in the LXI Output LAN Events

System Functions System

panel. The list can grow and shrink in response to Add and Remove commands respectively. New pages must be added and removed automatically as the list size changes. Only the first 14 characters of an LXI Output LAN Event name are displayed on the key.

Key Path	System, I/O Config, LXI, LXI Output LAN Events
Remote Command	:LXI:EVENT [:OUTPut] :LAN:LIST?
Example	:LXI:EVEN:LAN:LIST? Returns the complete list of Output LAN Events which is, at minimum: “LAN0”, “LAN1”, “LAN2”, “LAN3”, “LAN4”, “LAN5”, “LAN6”, “LAN7”, “WaitingForTrigger”, “Measuring”, “Sweeping”, “OperationComplete”, “Recalling”
Preset	Not affected by a Preset. The default values can be restored by pressing Restore Defs, Input/Output Settings. Preset/Default values: “LAN0”, “LAN1”, “LAN2”, “LAN3”, “LAN4”, “LAN5”, “LAN6”, “LAN7”, “WaitingForTrigger”, “Measuring”, “Sweeping”, “OperationComplete”, “Recalling”
State Saved	Saved in instrument state.
Instrument S/W Revision	Prior to A.02.00

Add (Remote Only) Adds the provided string to the list of possible LAN events to output as a response to instrument events. As new LAN events are added, keys are generated in the LXI Output LAN Events menu. New key panels are generated as the number of possible LAN events increases past a multiple of six, and the “More” keys are updated to reflect the new number of key panels in the LXI Output LAN Events menu.

Remote Command:	:LXI:EVENT [:OUTPut] :LAN:ADD “LANEVENT”
Example:	:LXI:EVEN:LAN:ADD “LANEVENT”
Restriction and Notes:	The maximum length of the string is 16 characters. Longer strings are concatenated and added to the LXI Output LAN Event list. No event is added if the LAN Event already exists.
State Saved:	No
Range:	Uppercase, Lowercase, Numeric, Symbol except for comma or semicolon
Instrument S/W Revision:	Prior to A.02.00

Remove (Remote Only) Removes the provided string from the list of possible LAN events to output as a response to instrument events. As new LAN events are removed, keys are removed from the LXI Output LAN Events menu. Key panels are removed as the number of possible LAN events decreases past a multiple of six, and the “More” keys are updated to reflect the new number of key panels in the LXI Output LAN Events menu. Events from the default list cannot be removed.

Remote Command:	:LXI:EVENT [:OUTPut] :LAN:REMOve [:EVENT] “LANEVENT”
Example:	:LXI:EVEN:LAN:REM “LANEVENT”

Restriction and Notes:	The maximum length of the string is 16 characters. Longer strings are concatenated and the resulting LAN Event is removed from the LXI Output LAN Event list. Nothing happens if the LAN event was not introduced using the Add command.
State Saved:	No
Range:	Uppercase, Lowercase, Numeric, Symbol
Instrument S/W Revision:	Prior to A.02.00

Remove All (Remote Only) Clears the list of custom LAN events (those introduced using the Add command) that are available to output as a response to instrument events. As new LAN events are removed, keys are removed from the LXI Output LAN Events menu. Key panels are removed as the number of possible LAN events decreases past a multiple of six, and the “More” keys are updated to reflect the new number of key panels in the LXI Output LAN Events menu.

Remote Command:	:LXI:EVENT[:OUTPUT]:LAN:REMOVE:ALL
Example:	:LXI:EVEN:LAN:REM:ALL
Restriction and Notes:	Only LAN Events added with the Add command are removed. Default events cannot be removed.
Instrument S/W Revision:	Prior to A.02.00

Source Sets the instrument event that this LXI Output LAN event is tied to.

The possible instrument events are “WaitingForTrigger”, “Sweeping”, “Measuring”, “OperationComplete”, and “Recalling”.

The key is labeled with the value of the selected source.

For the instrument event specific LXI Output LAN Events “WaitingForTrigger,” “Sweeping,” “Measuring,” “OperationComplete,” and “Recalling,” this parameter is set to the corresponding source value and cannot be changed. For these events, the Source key does not appear.

WaitingForTrigger, Measuring, and Sweeping correspond to the standard trigger state machine activities for which they are named.

OperationComplete is low when a measurement operation is underway. For example, OperationComplete is low throughout a list sweep measurement, even though Sweeping, Measuring, and WaitingForTrigger will undergo a number of transitions. In this case, OperationComplete goes high when the entire list sweep is finished.

Recalling is high while the instrument is actively recalling a state.

Additionally, the Source parameter can be set to the name of any Input LAN Event. This causes the Output LAN Event to be sent upon receipt of the named Input LAN Event. There is no front panel support for these events.

The default list of available Input LAN Events is:

- “LAN0”
- “LAN1”
- “LAN2”

System Functions

System

- “LAN3”
- “LAN4”
- “LAN5”
- “LAN6”
- “LAN7”
-

Key Path	System, I/O Config, LXI, LXI Output LAN Events, LAN[n]
Remote Command	:LXI:EVENT[:OUTPut]:LAN[:SET]:SOURCE "LANEVENT", "SourceEvent" :LXI:EVENT[:OUTPut]:LAN[:SET]:SOURCE? "LANEVENT"
Example	:LXI:EVEN:LAN:SOUR "LANEVENT";"WaitingForTrigger"
Restriction and Notes	The maximum length of the string is 45 characters.
Preset	Not affected by a Preset. The default values can be restored by pressing Restore Defs, Input/Output Settings. Preset/Default values: “Sweeping” (The Output LAN Events “WaitingForTrigger”, “Sweeping”, “Measuring”, “OperationComplete”, and “Recalling” all have default source parameters that match their names)
State Saved	Saved in instrument state.
Range	“WaitingForTrigger” “Sweeping” “Measuring” “OperationComplete” “Recalling” “LAN0” “LAN1” “LAN2” “LAN3” “LAN4” “LAN5” “LAN6” “LAN7” any user-added Input LAN Event
Instrument S/W Revision	Prior to A.02.00

Destination (Remote Only) Outgoing LAN events are sent to the hosts enumerated in the destination expression. This expression takes the form of “host1:port1, host2:port2,...” where port numbers are optional, and default to the IANA assigned TCP port (5044). To designate a UDP broadcast at the default port, set the destination string to “” or “ALL”. To designate a UDP broadcast at a specific port, set the destination string to “:port” or “ALL:port”.

Examples:

- “192.168.0.1:23”
- “agilent.com, soco.agilent.com”
- “agilent.com:80, 192.168.0.1”

Remote Command:	:LXI:EVENT[:OUTPut]:LAN[:SET]:DESTINATION "LANEVENT", "destinationExpression" :LXI:EVENT[:OUTPut]:LAN[:SET]:DESTINATION? "LANEVENT"
Example:	:LXI:EVEN:LAN:DEST "LANEVENT";"host1, 192.168.0.1:80"
Restriction and Notes:	The maximum length of the string is 45 characters.

Preset:	Not affected by a Preset. The default value of "ALL" can be restored by using the command: :SYSTem:DEFault INPut
State Saved:	Saved in instrument state.
Range:	Uppercase, Lowercase, Numeric, Symbol
Instrument S/W Revision:	Prior to A.02.00

Drive Determines the behavior of an output event.

- Normal designates typical operation, where both edges of the instrument event are transmitted,
- Off disables the LAN event.
- Wired-OR causes only one edge to be transmitted.

Key Path	System, I/O Config, LXI, LXI Output LAN Events, LAN[n]
Remote Command	:LXI:EVENT[:OUTPut]:LAN[:SET]:DRIVE "LANEVENT" , OFF NORMal WOR :LXI:EVENT[:OUTPut]:LAN[:SET]:DRIVE? "LANEVENT"
Example	:LXI:EVEN:LAN:DRIV "LANEVENT",WOR
Preset	Not affected by a Preset. The default value of "NORMal" can be restored by using the command: :SYSTem:DEFault INPut
State Saved	Saved in instrument state.
Range	OFF NORMal WOR
Instrument S/W Revision	Prior to A.02.00

Slope Slope determines which instrument event transition results in a LAN packet being sent and whether or not that edge is inverted.

When the Drive parameter is set to Normal, a Slope of Negative causes both edges to be inverted before they are transmitted. A Positive Slope transmits the edges unaltered.

When the Drive parameter is set to WOR, only Positive edges are transmitted. When the Slope is Negative, a falling edge is inverted and sent as a rising edge. When the Slope is Positive, a rising edge is sent normally.

The following table illustrates the effects of the Slope and Drive parameters.

Instrument Event Edge	Slope Parameter	Drive Parameter	Action
0	Negative	Off	Not sent
0	Positive	Off	Not sent
1	Negative	Off	Not sent

System Functions

System

1	Positive	Off	Not sent
0	Negative	Normal	1
0	Positive	Normal	0
1	Negative	Normal	0
1	Positive	Normal	1
0	Negative	Wired OR	1
0	Positive	Wired OR	Not sent
1	Negative	Wired OR	Not sent
1	Positive	Wired OR	0

Key Path	System, I/O Config, LXI, LXI Output LAN Events, LAN[n]
Remote Command	:LXI:EVENT[:OUTPUT]:LAN[:SET]:SLOPe "LANEVENT", POSitive NEGative :LXI:EVENT[:OUTPUT]:LAN[:SET]:SLOPe? "LANEVENT"
Example	:LXI:EVENT:LAN:SLOP "LANEVENT",POS
Preset	Not affected by a Preset. The default value of "Positive" can be restored by using the command: :SYSTEM:DEFAULT INPUT
State Saved	Saved in instrument state.
Range	POSitive NEGative
Instrument S/W Revision	Prior to A.02.00

Timestamp Delta This parameter represents a time in seconds to add to the timestamp of the Output LAN Event. This timestamp delta allows the receiving instrument to delay its response until the time specified in the timestamp.

Key Path	System, I/O Config, LXI, LXI Output LAN Events, LAN[n]
Remote Command	:LXI:EVENT[:OUTPUT]:LAN[:SET]:TSDelta "LANEVENT", <seconds> :LXI:EVENT[:OUTPUT]:LAN[:SET]:TSDelta? "LANEVENT"
Example	:LXI:EVENT:LAN:TSD "LANEVENT",10.5 s
Preset	Not affected by a Preset. The default value of "0.0 s" can be restored by using the command: :SYSTEM:DEFAULT INPUT
State Saved	Saved in instrument state.
Range	0.0 – 1.7976931348623157 x 10308 s (Max Double)
Instrument S/W Revision	Prior to A.02.00

Enabled If this parameter is set to ON, this LAN Event is sent when the selected Source instrument event occurs. Otherwise, this LAN Event is never output.

Key Path	System, I/O Config, LXI, LXI Output LAN Events, LAN[n]
Remote Command	:LXI:EVENT[:OUTPut]:LAN[:SET]:ENABLEd "LANEVENT", ON OFF 1 0 :LXI:EVENT[:OUTPut]:LAN[:SET]:ENABLEd? "LANEVENT"
Example	:LXI:EVEN:LAN:ENAB "LAN0",ON
Preset	Not affected by a Preset. The default value of "OFF" can be restored by using the command: :SYSTem:DEFault INPut
State Saved	Saved in instrument state.
Range	OFF ON 0 1
Instrument S/W Revision	Prior to A.02.00

Count (Remote Only) Returns the number of items in the LXI Output LAN Event List.

Remote Command:	:LXI:EVENT[:OUTPut]:LAN:COUNT?
Example:	:LXI:EVEN:LAN:COUN?
Instrument S/W Revision:	Prior to A.02.00

Configure (Remote Only) Allows the configuration of some of the above parameters from a single SCPI command.

Remote Command:	:LXI:EVENT[:OUTPut]:LAN[:SET]:CONFigure "lanEvent", <enabled>, <source>, <slope>, <drive>, <destination>
Example:	:LXI:EVEN:LAN:CONF "LAN0",1,"WaitingForTrigger",POS,NORM,"ALL"
Instrument S/W Revision:	Prior to A.02.00

Send (Remote Only) Forces the instrument to send the requested LAN Event. The LAN Event must be enabled, otherwise this command is ignored.

Remote Command:	:LXI:EVENT[:OUTPut]:LAN:SEND "LANEVENT", RISE FALL
Example:	:LXI:EVEN:LAN:SEND "LANEVENT", FALL
Instrument S/W Revision:	Prior to A.02.00

Identifier (Remote Only) Sets the string that will be placed in the peer-to-peer packet when the Output LAN Event is transmitted. The Identifier is variable to allow for easier system debugging. The Identifier must be unique,

System Functions

System

for example the “LAN0” and “LAN1” output events cannot have identical identifiers.

Remote Command:	:LXI:EVENT[:OUTPUT]:LAN[:SET]:IDENTIFIER "LANEVENT", "identifier" :LXI:EVENT[:OUTPUT]:LAN[:SET]:IDENTIFIER? "LANEVENT"
Example:	:LXI:EVENT:LAN:IDEN"LAN0","debugstring"
Restriction and Notes:	The maximum length of the string is 16 characters. Nothing happens if the LAN event does not exist. The default value is that the identifier is equivalent to the name of the LAN Event.
State Saved:	Saved in instrument state.
Range:	Uppercase, Lowercase, Numeric, Symbol
Instrument S/W Revision:	Prior to A.02.00

IEEE 1588 Time (Remote Only)

Time Epoch Time (Remote Only) If the device is selected as the IEEE 1588 master clock, this sets the clock using the number of seconds elapsed since January, 1 1970 at 00:00:00 in International Atomic Time (TAI). Epoch time is time zone invariant. Otherwise, this allows you to query the epoch time.

Remote Command:	:LXI:CLOCK[:TIME][:VALUE] <seconds>,<fractionalSeconds>
Example:	:LXI:CLOCK 10020304.0 s,0.123456 s
Restriction and Notes:	The seconds argument must only contain values representing whole seconds. For example 1243.0 s is acceptable, but 1243.01 results in an error. Ignored when the device is not selected as the IEEE 1588 master clock. The fractional portion is only accurate to the microseconds position. Error generated if the seconds argument contains a fractional portion.
Preset:	Not affected by a Preset. The default value of "System Time" can be restored by using the command: :SYSTEM:DEFAULT INPUT
State Saved:	No
Range:	Seconds: 0.0 – 1.7976931348623157 x 10 ³⁰ s (Max Double) Fraction: 0.0 s – 0.999999 s
Instrument S/W Revision:	Prior to A.02.00
Remote Command:	:LXI:CLOCK[:TIME][:VALUE]?
Example:	:LXI:CLOCK?

Restriction and Notes:	The seconds argument must only contain values representing whole seconds. For example 1243.0 s is acceptable, but 1243.01 results in an error. Ignored when the device is not selected as the IEEE 1588 master clock. The fractional portion is only accurate to the microseconds position. Error generated if the seconds argument contains a fractional portion.
Preset:	System time
State Saved:	No
Range:	Seconds: 0.0 – 1.7976931348623157 x 10308 s (Max Double) Fraction: 0.0 s – 0.999999 s
Instrument S/W Revision:	Prior to A.02.00

Seconds (Remote Only) If the device is selected as the IEEE 1588 master clock, this sets the seconds portion of the clock. Otherwise, this allows you to query the seconds portion of the epoch time. Valid values are in discrete increments of whole seconds.

Remote Command:	:LXI:CLOCK[:TIME]:SECONDS <seconds> :LXI:CLOCK[:TIME]:SECONDS?
Example:	:LXI:CLOC:SEC 10020304.0
Restriction and Notes:	Ignored when the device is not selected as the IEEE 1588 master clock. Error generated if the argument contains a fractional portion. For example 1243.0 s is acceptable, but 1243.01 results in an error.
Preset:	Not affected by a Preset. The default value of "System Time" can be restored by using the command: :SYSTEM:DEFAULT INPUT
State Saved:	No
Range:	0.0 – 1.7976931348623157 x 10308 s (Max Double)
Instrument S/W Revision:	Prior to A.02.00

Fraction (Remote Only) If the device is selected as the IEEE 1588 master clock, this sets the sub-second value of the clock. Otherwise, this allows you to query the sub-second value of the epoch time.

Remote Command:	:LXI:CLOCK[:TIME]:FRACTION <fraction> :LXI:CLOCK[:TIME]:FRACTION?
Example:	:LXI:CLOC:FRAC 10 ms
Restriction and Notes:	Ignored when the device is not selected as the IEEE 1588 master clock. Only accurate to the microseconds position.
Preset:	Sub-second value of system time

System Functions System

State Saved: No
Range: [0.0,1.0)
Instrument S/W Revision: Prior to A.02.00

Local Time (Remote Only) Returns the current local time formatted as a date time string.

Remote Command: :LXI:CLOCK[:TIME]:LOCAL?
Example: :LXI:CLOC:LOC? Returns "5/15/2007 6:23:34.123456"
Notes: LXI:CLOCK[:TIME]:LOCAL? Returns Any string constituting a valid date and time
Instrument S/W Revision: Prior to A.02.00

Leap Second Offset (Remote Only) Enables you to set the leap second offset between the UTC and TAI time standards.

Remote Command: :LXI:CLOCK[:TIME]:LSOFFSET <integer>
:LXI:CLOCK[:TIME]:LSOFFSET?
Example: :LXI:CLOC:LSOF 55
Range: 0 – 2147483647 (Max Integer)
Instrument S/W Revision: Prior to A.02.00

International Atomic Time (Remote Only) Retrieves the current time using the TAI format.

Remote Command: :LXI:CLOCK[:TIME]:TAI?
Example: :LXI:CLOC:TAI? "5/15/2007 6:23:34.123456"
Notes: :LXI:CLOCK[:TIME]:TAI? Returns Any string constituting a valid date and time
Instrument S/W Revision: Prior to A.02.00

Time Zone (Remote Only) Retrieves the current local time zone as an offset in hours, minutes, and seconds from Greenwich Mean Time.

Remote Command: :LXI:CLOCK[:TIME]:TZON?
Example: :LXI:CLOC:TZON?
Notes: :LXI:CLOC:TZON? returns "01:00:00" if the current local time zone is 1 hour ahead from Greenwich Mean Time
Instrument S/W Revision: Prior to A.02.00

Daylight Savings (Remote Only) Retrieves the current status of the Windows System setting for Daylight

Savings Time. Whether or not daylight savings time is in effect influences the time zone parameter.

Remote Command: : LXI : CLOCk [: TIME] : DLSavings?
 Example: : LXI : CLOC : DLS?
 Notes: : LXI : CLOC : DLS? Returns 1 when Daylight Savings Time is On and 0 if the
 when Daylight Savings Time is Off
 Instrument S/W Revision: Prior to A.02.00

Coordinated Universal Time (Remote Only) Retrieves the current time using the UTC format.

Remote Command: : LXI : CLOCk [: TIME] : UTC?
 Example: : LXI : CLOC : UTC? "5/15/2007 6:23:34.123456"
 Notes: : LXI : CLOC : UTC? Returns Any string constituting a valid date and time
 Instrument S/W Revision: Prior to A.02.00

Time Marker (Remote Only) Records the PTP time as a marker that can later be measured against the current PTP time. Typical use is to time the length of a sequence of instrument operations. There are 9 available markers with indices 1 – 9.

Remote Command: : LXI : CLOCk [: TIME] : MARKer [1] | 2 | 3 | 4 | 5 | 6 | 7 | 8 | 9 [: SET]
 Example: : LXI : CLOC : MARK1
 : LXI : CLOC : MARK2
 : LXI : CLOC : MARK3
 : LXI : CLOC : MARK4
 : LXI : CLOC : MARK5
 : LXI : CLOC : MARK6
 : LXI : CLOC : MARK7
 : LXI : CLOC : MARK8
 : LXI : CLOC : MARK9
 : LXI : CLOC : MARK
 Instrument S/W Revision: Prior to A.02.00

Time Marker Clear (Remote Only) Clears the recorded PTP time marker used to measure against the current PTP time. There are 9 available markers with indices 1 – 9.

Remote Command: : LXI : CLOCk [: TIME] : MARKer [1] | 2 | 3 | 4 | 5 | 6 | 7 | 8 | 9 : CLEAR

System Functions System

Example: : LXI:CLOC:MARK1:CLEA
 : LXI:CLOC:MARK2:CLEA
 : LXI:CLOC:MARK3:CLEA
 : LXI:CLOC:MARK4:CLEA
 : LXI:CLOC:MARK5:CLEA
 : LXI:CLOC:MARK6:CLEA
 : LXI:CLOC:MARK7:CLEA
 : LXI:CLOC:MARK8:CLEA
 : LXI:CLOC:MARK9:CLEA
 : LXI:CLOC:MARK:CLEA

Instrument S/W Revision: Prior to A.02.00

Time Marker Delta (Remote Only) Calculates and returns the delta time from the marker to the present PTP time. Also returns the seconds and sub-seconds portions of the start and end times. There are 9 available markers with indices 1 – 9.

Remote Command: : LXI:CLOCK[:TIME]:MARKer[1]|2|3|4|5|6|7|8|9:DELta?

Example: : LXI:CLOC:MARK1:DELT? returns
 <deltaTime>,<startSeconds>,<startFractionalSeconds>,<endSeconds>,<endFractionalSeconds>
 : LXI:CLOC:MARK2:DELT?
 : LXI:CLOC:MARK3:DELT?
 : LXI:CLOC:MARK4:DELT?
 : LXI:CLOC:MARK5:DELT?
 : LXI:CLOC:MARK6:DELT?
 : LXI:CLOC:MARK7:DELT?
 : LXI:CLOC:MARK8:DELT?
 : LXI:CLOC:MARK9:DELT?
 : LXI:CLOC:MARK:DELT?

Notes: : LXI:CLOCK[:TIME]:MARKer[1]|2|3|4|5|6|7|8|9:DELta? Returns a value between 0.0 – 1.7976931348623157 x 10308 s (Max Double)

Range: 0.0 – 1.7976931348623157 x 10308 s (Max Double)

Instrument S/W Revision: Prior to A.02.00

Measurement Data Timestamp (Remote Only) Returns the beginning and ending times of the last measurement cycle. This command also returns the duration of the measurement cycle. These values correspond to the last rising and falling transition of the Measuring instrument event.

Remote Command: : LXI:CLOCK[:TIME]:MEASure[:DELta]?

Example: :LXI:CLOC:MEAS? Returns 2.0,1145902.0,0.123456, ,1145904.0,0.123456

Notes: :LXI:CLOCK[:TIME]:MARKer[1]|2|3|4|5|6|7|8|9:DELTA? Returns a value between 0.0 – 1.7976931348623157 x 10308 s (Max Double)

Instrument S/W Revision: Prior to A.02.00

Clear Measurement Data Timestamp (Remote Only) Forces the return values of the Measurement Data Timestamp to zero until the next measurement cycle occurs. This command need not be issued for the Measurement Data Timestamp to be refreshed.

Remote Command: :LXI:CLOCK[:TIME]:MEASure:CLEAr

Example: :LXI:CLOC:MEAS:CLE

Instrument S/W Revision: Prior to A.02.00

Precision Time Protocol Precision Time Protocol, as defined by IEEE 1588, is a method for synchronizing the time across a network. Instruments participating in the PTP network can coordinate activities using this common time base.

Accuracy (Remote Only) Sets the typical offset from the correct time that a user can expect from the instrument PTP clock. This parameter is used when the instrument is selected as the Master clock. It should be set along with the time when configuring a master clock.

The value should be chosen by judging how precisely the clock can be set to the exact TAI time and the accuracy and drift of the clock's underlying oscillator.

This is an input to the IEEE 1588 Best Master Clock algorithm.

Remote Command: :LXI:CLOCK:PTP:ACCuracy
NS25|NS100|NS250|NS1000|NS2500|US10|US25|US100|US250|US1000|US2500|MS10|MS25|MS100|MS1000|S10|GT10S|UNKNown
:LXI:CLOCK:PTP:ACCuracy?

Example: :LXI:CLOC:PTP:ACC US25

Preset: Not affected by a Preset. The default value of "GT10S" can be restored by using the command:
SYSTEM:DEFault INPut

Range: NS25|NS100|NS250|NS1000|NS2500|US10|US25|US100|US250|US1000|US2500|MS10|MS25|MS100|MS1000|S10|GT10S|UNKNown

Instrument S/W Revision: Prior to A.02.00

Announce Interval (Remote Only) Sets the time in seconds between PTP announce packets. A shorter interval makes the system more responsive to changes in the master clock at the cost of network bandwidth and packet processing time. The announce interval should be constant across all the instruments in the network. The announce

System Functions System

interval will be rounded to the nearest non-negative integer power of two, with a maximum value of 16.

Remote Command: : LXI : CLOCk : PTP : ANNounce : INTerval <interval>
 : LXI : CLOCk : PTP : ANNounce : INTerval?

Example: : LXI : CLOC : PTP : ANN : INT 1

Preset: Not affected by a Preset. The default value of "4" can be restored by using the command:
 SYSTem : DEFault INPut

Range: 1|2|4|8|16

Instrument S/W Revision: Prior to A.02.00

Announce Receipt Time Out (Remote Only) Sets the number of announce intervals that the instrument waits to receive an announce packet while in the Slave or Listening. After this number of announce intervals, the instrument will transition to the Master state.

Remote Command: : LXI : CLOCk : PTP : ANNounce : RTOut <numberOfIntervals>
 : LXI : CLOCk : PTP : ANNounce : RTOut?

Example: : LXI : CLOC : PTP : ANN : RTO 5

Preset: Not affected by a Preset. The default value of "3" can be restored by using the command:
 SYSTem : DEFault INPut

Min: 2

Max: 10

Instrument S/W Revision: Prior to A.02.00

Clock Class (Remote Only) Returns a ranking of master clock suitability relative to other clocks on the network. A lower value represents a more suitable clock.

Suitability is defined by the IEEE 1588 standard section 7.6.2.4

Remote Command: : LXI : CLOCk : PTP : CCLass?

Example: : LXI : CLOC : PTP : CCL?

Preset: Not affected by a Preset. The default value of "248" can be restored by using the command:
 SYSTem : DEFault INPut

Min: 6

Max: 248

Instrument S/W Revision: Prior to A.02.00

Deviation (Remote Only) Returns the standard deviation of the instrument's PTP time from the Grandmaster's

PTP time.

Remote Command: :LXI:CLOCK:PTP:DEVIation?
 Example: :LXI:CLOC:PTP:DEV?
 Instrument S/W Revision: Prior to A.02.00

Domain (Remote Only) The instrument synchronizes its clock only with other clocks in the same domain.

Remote Command: :LXI:CLOCK:PTP:DOMain <domainNumber>
 :LXI:CLOCK:PTP:DOMain?
 Example: :LXI:CLOC:PTP:DOM 0
 Preset: Not affected by a Preset. The default value of "0" can be restored by using the command:
 SYSTem:DEFault INPut
 Min: 0
 Max: 127
 Instrument S/W Revision: Prior to A.02.00

Offset (Remote Only) Returns the difference between the instrument clock PTP time and the Master clock PTP time.

Remote Command: :LXI:CLOCK:PTP:OFFSet?
 Example: :LXI:CLOC:PTP:OFFS?
 Range: 0.0 to - 1.7976931348623157 x 10308 s (Min Double)
 Instrument S/W Revision: Prior to A.02.00

First Priority (Remote Only) Setting this parameter overrides the IEEE 1588 Best Master Clock algorithm. If an instrument's First Priority parameter is smaller than all other clocks in its domain, it is chosen as the Master clock.

Remote Command: :LXI:CLOCK:PTP:PRIority:FIRSt <priority>
 :LXI:CLOCK:PTP:PRIority:FIRSt?
 Example: :LXI:CLOC:PTP:PRI:FIRS 50
 Preset: Not affected by a Preset. The default value of "128" can be restored by using the command:
 SYSTem:DEFault INPut
 Min: 0
 Max: 255
 Instrument S/W Revision: Prior to A.02.00

System Functions

System

Second Priority (Remote Only) When two or more clocks are determined to be equally good by the Best Master Clock algorithm, the clock with the lowest Second Priority value is chosen to be the Master Clock.

Remote Command: : LXI : CLOcK : PTP : PRIOrity : SECond <priority>
 : LXI : CLOcK : PTP : PRIOrity : SECond?

Example: : LXI : CLOcK : PTP : PRI : SEC 50

Preset: Not affected by a Preset. The default value of "128" can be restored by using the command:
 SYSTem : DEFault INPut

Min: 0

Max: 255

Instrument S/W Revision: Prior to A.02.00

State (Remote Only) Returns the current state of the instrument's PTP clock as defined in the IEEE 1588 standard.

Remote Command: : LXI : CLOcK : PTP : STATe?

Example: : LXI : CLOcK : PTP : STAT?

Range: INITializing|FAULTy|DISAbled|LISTening|PREMaster|
 MASTer|PASSive|UNCalibrated|SLAVE

Instrument S/W Revision: Prior to A.02.00

Traceability (Remote Only) Returns the quality of the instrument's PTP clock source of time when chosen as the Grand Master clock.

This parameter is used by the Best Master Clock algorithm.

Remote Command: : LXI : CLOcK : PTP : TRACeability?

Example: : LXI : CLOcK : PTP : TRAC?

Range: ATOMic|GPS|RADio|PTP|NTP|HANDset|OTHer|OSCillator

Instrument S/W Revision: Prior to A.02.00

Variance (Remote Only) Returns the variance of the instrument's PTP clock time relative to the Master's PTP clock time.

Remote Command: : LXI : CLOcK : PTP : VARiance?

Example: : LXI : CLOcK : PTP : VAR?

Range: 0.0 – 1.7976931348623157 x 10308 (Max Double)

Instrument S/W Revision: Prior to A.02.00

Sync Interval (Remote Only) Sets the rate at which PTP sync packets are transmitted when this instrument is acting as a Master PTP clock. The values must be integer powers of 2.

Remote Command: : LXI : CLOCk : PTP : SINTerval <seconds>
 Example: : LXI : CLOC : PTP : SINT 0.25s
 Preset: Not affected by a Preset. The default value of "1" can be restored by using the command:
 SYSTem : DEFault INPut
 Range: 0.0625s | 0.125s | 0.25s | 0.5s | 1s | 2s
 Instrument S/W Revision: Prior to A.02.00

Remote Command: : LXI : CLOCk : PTP : SINTerval?
 Example: : LXI : CLOC : PTP : SINT?
 Preset: 1
 Range: 0.0625s | 0.125s | 0.25s | 0.5s | 1s | 2s
 Instrument S/W Revision: Prior to A.02.00

Delay Request Interval (Remote Only) This property is used by the master clock to specify the interval between delay request packets sent from the slave to the master clock. Slaves use a randomly-chosen interval, with mean equal to this property.

The value for this parameter must be an integer power of two.

Remote Command: : LXI : CLOCk : PTP : DRINterval <seconds>
 Example: : LXI : CLOC : PTP : DRIN 15 ms
 Preset: Not affected by a Preset. The default value of "8 s" can be restored by using the command:
 SYSTem : DEFault INPut
 Range: 1 s | 2 s | 4 s | 8 s | 16 s | 32 s
 Instrument S/W Revision: Prior to A.02.00

Remote Command: : LXI : CLOCk : PTP : DRINterval?
 Example: : LXI : CLOC : PTP : DRIN 15 ms
 Preset: 8 s
 Min: 0.0 s
 Max: 2³² = 4294967296 s
 Instrument S/W Revision: Prior to A.02.00

Grand Master Accuracy (Remote Only) Returns the relative accuracy of the Grand Master clock.

Remote Command: :LXI:CLOCK:PTP:GMASter:ACCuracy?
Example: :LXI:CLOC:PTP:GMAS:ACC? For example, this might return GT10S.
Range: 25NS|100NS|250NS|1US|2.5US|10US|25US|100US|250US|1MS|2.5MS|10MS|25MS|100MS|1S|10S|GT10S|UNKNown
Instrument S/W Revision: Prior to A.02.00

MAC Address (Remote Only) Returns the Grand Master's MAC Address.

Remote Command: :LXI:CLOCK:PTP:GMASter:MADDress?
Example: :LXI:CLOC:PTP:GMAS:MADD? For example, this might return "00-00-50-1e-ca-ad".
Range: Uppercase, Lowercase, Numeric, Symbol
Instrument S/W Revision: Prior to A.02.00

Traceability (Remote Only) Describes the quality of the Grand Master PTP clock's source of time.

Remote Command: :LXI:CLOCK:PTP:GMASter:TRACeability?
Example: :LXI:CLOC:PTP:GMAS:TRAC? For example, this might return OSC.
Range: ATOMIC|GPS|RADIO|PTP|NTP|HANDset|OTHer|OSCillator
Instrument S/W Revision: Prior to A.02.00

Master MAC Address (Remote Only) Returns the Master's MAC Address.

Remote Command: :LXI:CLOCK:PTP:MASter:MADDress?
Example: :LXI:CLOC:PTP:MASt:MADD?
Range: Uppercase, Lowercase, Numeric, Symbol
Instrument S/W Revision: Prior to A.02.00

Servo Algorithm (Remote Only) The Servo Algorithm parameters are considered advanced settings for tweaking IEEE 1588 performance.

Log (Remote Only) The Servo Log records measurements of the offset between the instrument's PTP clock and the Master's PTP clock. It also records the packet travel time for Master-to-Slave and Slave-to-Master transactions.

Next (Remote Only) Retrieves and removes the oldest entry from the Servo Log. The format for a servo log entry is as follows

Sample Index: integer representing entry order
Time Seconds: seconds portion of the entry timestamp

Time Fraction: sub-second portion of the entry timestamp
 Offset Seconds: offset between the instrument's PTP clock and the Master's PTP clock
 Average Delay Seconds: the average measured transmission delay
 Master Delay Seconds: Master-to-Slave packet travel time
 Slave Delay Seconds: Slave-to-Master packet travel time

Remote Command: :LXI:CLOCK:SALGORITHM:LOG[:NEXT]?

Example: :LXI:CLOC:SALG:LOG?

Range: Uppercase, Lowercase, Numeric, Symbol

Instrument S/W Revision: Prior to A.02.00

Circular (Remote Only) Sets the behavior for entries occurring while the Servo Log is full.

- If Circular is set to 1, incoming events overwrite the oldest events in the log.
- If Circular is set to 0, incoming events are discarded.

Remote Command: :LXI:CLOCK:SALGORITHM:LOG:CIRCULAR[:ENABLED] ON|OFF|0|1
 :LXI:CLOCK:SALGORITHM:LOG:CIRCULAR[:ENABLED]?

Example: :LXI:CLOC:SALG:LOG:CIRC 1

Preset: Not affected by a Preset. The default value of "1" can be restored by using the command:

SYSTEM:DEFAULT INPUT

Range: ON|OFF|0|1

Instrument S/W Revision: Prior to A.02.00

Beginning Entry (Remote Only) Sets or freezes the beginning entry of the log when in circular mode to the most recently added entry at the time of the command. This is so that the :LXI:EVENT:LOG:ENTRY? command has a reference entry for indexing individual entries in the log.

Remote Command: :LXI:CLOCK:SALGORITHM:LOG:CIRCULAR:FBENTRY

Example: LXI:CLOCK:SALG:LOG:CIRC:FBEN

Instrument S/W Revision: Prior to A.02.00

Clear (Remote Only) Clears all entries from the Servo Log.

Remote Command: :LXI:CLOCK:SALGORITHM:LOG:CLEAR

Example: :LXI:CLOC:SALG:LOG:CLEAR

Instrument S/W Revision: Prior to A.02.00

System Functions System

Count (Remote Only) Returns the number of unread entries in the Servo Log.

Remote Command: :LXI:CLOCK:SALGORITHM:LOG:COUNT?
Example: :LXI:CLOC:SALG:LOG:COUN?
Range: 0 - IEEE 1588 Servo Log Size
Instrument S/W Revision: Prior to A.02.00

Enabled (Remote Only) •When the Servo Log is disabled, no events are recorded.

- When it is enabled, the Servo Log is active.
-

Remote Command: :LXI:CLOCK:SALGORITHM:LOG:ENABLED ON|OFF|0|1
:LXI:CLOCK:SALGORITHM:LOG:ENABLED?
Example: :LXI:CLOC:SALG:LOG:ENAB 1
Preset: Not affected by a Preset. The default value of "0" can be restored by using the command:
SYSTem:DEFault INPut
Range: ON|OFF|0|1
Instrument S/W Revision: Prior to A.02.00

Size (Remote Only) Sets the maximum number of entries to store in the Servo Log.

Remote Command: :LXI:CLOCK:SALGORITHM:LOG:SIZE <maxLogEntries>
:LXI:CLOCK:SALGORITHM:LOG:SIZE?
Example: :LXI:CLOC:SALG:LOG:SIZE 100
Preset: Not affected by a Preset. The default value of "256" can be restored by using the command:
SYSTem:DEFault INPut
Min: 0
Max: 1024
Instrument S/W Revision: Prior to A.02.00

All (Remote Only) Non-destructively returns the entire contents of the Servo Log.

Remote Command: :LXI:CLOCK:SALGORITHM:LOG:ALL?
Example: :LXI:CLOC:SALG:LOG?
Range: Uppercase, Lowercase, Numeric, Symbol

Instrument S/W Revision: Prior to A.02.00

Specific Entry (Remote Only) Non-destructively returns a specifically indexed entry from within the Servo Log.

Remote Command: :LXI:CLOCK:SALGORITHM:LOG:ENTRY? <intIndex>

Example: :LXI:CLOC:SALG:LOG? 0 Returns the oldest entry in the Servo Log.
Example of result :
"1,1208978798,139644871,0.000000000,3.393600e+038,0.000000000,0.000000000,0.000000000"

Range: Uppercase, Lowercase, Numeric, Symbol

Instrument S/W Revision: Prior to A.02.00

Statistics (Remote Only) Returns the long-term statistics of the servo log that characterizes the performance of the instrument PTP clock's offset from the master PTP clock. The statistics include the following values:

- Number of samples (an integer)
- Mean offset (a double)
- Standard deviation of the offset (a double)
- Maximum offset (a double)
- Minimum offset (a double)

Remote Command: :LXI:CLOCK:SALGORITHM:LOG:STATISTICS[:DATA]?

Example: :LXI:CLOC:SALG:LOG:STAT? Example of result :
"3643,0.000000000,0.000000000,0.000000000,0.000000000"

Instrument S/W Revision: Prior to A.02.00

Clear Statistics (Remote Only) Resets the long-term servo performance statistics.

Remote Command: :LXI:CLOCK:SALGORITHM:LOG:STATISTICS:CLEAR

Example: :LXI:CLOC:SALG:LOG:STAT? Example of result :
"3643,0.000000000,0.000000000,0.000000000,0.000000000"

Instrument S/W Revision: Prior to A.02.00

Asymmetry (Remote Only) Sets the difference in seconds between the Master-to-Slave packet travel time and the Slave-to-Master packet travel time.

Remote Command: :LXI:CLOCK:SALGORITHM[:SET]:ASYMMETRY <seconds>

:LXI:CLOCK:SALGORITHM[:SET]:ASYMMETRY?

Example: :LXI:CLOC:SALG:ASYM 15 ns

System Functions System

Preset: Not affected by a Preset. The default value of "0.0 s " can be restored by using the command:
SYSTem:DEFault INPut

Min: -1

Max: 1

Instrument S/W Revision: Prior to A.02.00

Coarse/Fine Threshold (Remote Only) Determines when the PTP clock Servo algorithm uses the 'Fine' or 'Coarse' parameters for adjusting the instrument's PTP clock time. The threshold is measured against a running estimate of the servo variance.

Coarse mode causes a slave clock to converge with the master clock more quickly, but it is more sensitive to noise, while Fine mode filters out noise more effectively, but takes longer to converge.

Remote Command: :LXI:CLOCK:SALGorithm[:SET]:CFTHreshold
<secondsSquared>
:LXI:CLOCK:SALGorithm[:SET]:CFTHreshold?

Example: :LXI:CLOC:SALG:CFTH 0.25

Preset: Not affected by a Preset. The default value of "1.0e-11 " can be restored by using the command:
SYSTem:DEFault INPut

Min: 0

Max: 1

Instrument S/W Revision: Prior to A.02.00

Coarse Proportional Constant (Remote Only) This constant is used by the servo when above the Coarse/Fine Threshold variance. Decreasing this constant causes the servo to become less responsive to both noise in the system and changes in the Master Clock's rate. Conversely, increasing this constant causes the servo to respond more energetically to both system noise and changes in the Master Clock's rate.

The ratio between the Proportional and Integral constants should remain roughly constant.

Remote Command: :LXI:CLOCK:SALGorithm[:SET]:CPConstant <servoConstant>
:LXI:CLOCK:SALGorithm[:SET]:CPConstant?

Example: :LXI:CLOC:SALG:CPC 0.5

Preset: Not affected by a Preset. The default value of "0.4 " can be restored by using the command:
SYSTem:DEFault INPut

Min: 0

Max: 1

Instrument S/W Revision: Prior to A.02.00

Coarse Integral Constant (Remote Only) This constant is used by the servo when above the Coarse/Fine Threshold variance. Decreasing this constant causes the servo to become less responsive to both noise in the system and changes in the Master Clock's rate. Conversely, increasing this constant causes the servo to respond more energetically to both system noise and changes in the Master Clock's rate.

The ratio between the Proportional and Integral constants should remain roughly constant.

Remote Command: : LXI: CLOcK: SALGorithm[: SET]: CIConstant <servoConstant>
 : LXI: CLOcK: SALGorithm[: SET]: CIConstant?

Example: : LXI: CLOC: SALG: CIC 0.5

Preset: Not affected by a Preset. The default value of "0.2 " can be restored by using the command:

SYSTem: DEFault INPut

Min: 0

Max: 1

Instrument S/W Revision: Prior to A.02.00

Fine Proportional Constant (Remote Only) This constant is used by the servo when below the Coarse/Fine Threshold variance. Decreasing this constant causes the servo to become less responsive to both noise in the system and changes in the Master Clock's rate. Conversely, increasing this constant causes the servo to respond more energetically to both system noise and changes in the Master Clock's rate.

The ratio between the Proportional and Integral constants should remain roughly constant.

Remote Command: : LXI: CLOcK: SALGorithm[: SET]: FPConstant <servoConstant>
 : LXI: CLOcK: SALGorithm[: SET]: FPConstant?

Example: : LXI: CLOC: SALG: FPC 1

Preset: Not affected by a Preset. The default value of "0.35 " can be restored by using the command:

SYSTem: DEFault INPut

Min: 0

Max: 1

Instrument S/W Revision: Prior to A.02.00

Fine Integral Constant (Remote Only) This constant is used by the servo when below the Coarse/Fine Threshold variance. Decreasing this constant causes the servo to become less responsive to both noise in the system and changes in the Master Clock's rate. Conversely, increasing this constant causes the servo to respond more energetically to both system noise and changes in the Master Clock's rate.

The ratio between the Proportional and Integral constants should remain roughly constant.

Remote Command: : LXI: CLOcK: SALGorithm[: SET]: FIConstant <servoConstant>
 : LXI: CLOcK: SALGorithm[: SET]: FIConstant?

System Functions

System

Example: :LXI:CLOC:SALG:FIC 0.6

Preset: Not affected by a Preset. The default value of "0.05" can be restored by using the command:
SYSTem:DEFault INPut

Min: 0

Max: 1

Instrument S/W Revision: Prior to A.02.00

Maximum Outlier Discard Count (Remote Only) Sets the maximum number of outlier packets to ignore. After this maximum is exceeded, the next packet is accepted, regardless of whether or not it is flagged as an outlier.

Remote Command: :LXI:CLOCK:SALGorithm[:SET]:OMAXimum
<consecutiveSamples>
:LXI:CLOCK:SALGorithm[:SET]:OMAXimum?

Example: :LXI:CLOC:SALG:OMAX 3

Preset: Not affected by a Preset. The default value of "5" can be restored by using the command:
SYSTem:DEFault INPut

Min: 0

Max: 25

Instrument S/W Revision: Prior to A.02.00

Outlier Threshold (Remote Only) Defines the threshold for determining whether a packet is considered a statistical outlier. If a sync or delay request is held up in a switch for a significant amount of time, the quality of synchronization will be perturbed. The servo ignores anything outside the outlier threshold. This parameter is expressed as a number of standard deviations from the currently measured average packet latency. Note that the value can be set to fractional standard deviations.

Remote Command: :LXI:CLOCK:SALGorithm[:SET]:OTHReshold
<standardDeviations>
:LXI:CLOCK:SALGorithm[:SET]:OTHReshold?

Example: :LXI:CLOC:SALG:OTHR 1.0

Preset: Not affected by a Preset. The default value of "5.0" can be restored by using the command:
SYSTem:DEFault INPut

Min: 0.25

Max: 6.0

Instrument S/W Revision: Prior to A.02.00

Outlier Threshold Enable (Remote Only) Enables the outlier threshold to determine whether or not outliers are discarded.

Remote Command: : LXI: CLOCk: SALGorithm[: SET]: OTENable ON|OFF|1|0
 : LXI: CLOCk: SALGorithm[: SET]: OTENable?

Example: : LXI: CLOC: SALG: OTEN OFF

Preset: Not affected by a Preset. The default value of "OFF" can be restored by using the command:
 SYSTem: DEFault INPut

Instrument S/W Revision: Prior to A.02.00

Set/Steer Threshold (Remote Only) If the instrument's clock deviates from the master by an amount equal to or greater than this threshold, it is reset to match the master rather than being gradually steered toward it.

Remote Command: : LXI: CLOCk: SALGorithm[: SET]: STHReshold <seconds>
 : LXI: CLOCk: SALGorithm[: SET]: STHReshold?

Example: : LXI: CLOC: SALG: STHR 15 ms

Preset: Not affected by a Preset. The default value of "0.1 s " can be restored by using the command:
 SYSTem: DEFault INPut

Min: 0.0001

Max: 10.0

Instrument S/W Revision: Prior to A.02.00

Configure (Remote Only) Allows the configuration of some of the above parameters from a single SCPI command.

Remote Command: : LXI: CLOCk: SALGorithm[: SET]: CONFigure <asymmetry>, <coarse fine threshold>, <cpc>, <cic>, <fpc>, <fic>, <maximum outlier discard>, <outlier threshold>, <set/steer threshold>

Example: : LXI: CLOC: SALG: CONF 0.0, 2.0E-13, 0.4, 0.2, 0.35, 0.05, 5, 2.0E-4, 0.1s

Instrument S/W Revision: Prior to A.02.00

Synchronization (Remote Only) Master (Remote Only) Reports whether or not the device has been selected as the PTP master clock.

Remote Command: : LXI: CLOCk: SYNC: MASTer?

Example: : LXI: CLOC: SYNC: MAST?

Range: ON|OFF|0|1

System Functions System

Instrument S/W Revision: Prior to A.02.00

Local Enabled (Remote Only) Enable steering of the local clock with the PTP IEEE 1588 clock.

Remote Command: :LXI:CLOCK:SYNC:LOCAL:ENABLED ON|OFF|0|1
:LXI:CLOCK:SYNC:LOCAL:ENABLED?

Example: :LXI:CLOC:SYNC:LOC:ENAB ON

Preset: Not affected by a Preset. The default value of "ON" can be restored by using the command:

SYSTem:DEFault INPut

Range: ON|OFF|0|1

Instrument S/W Revision: Prior to A.02.00

Local Interval (Remote Only) The local clock is updated after the time set in the Local Interval elapses.

Remote Command: :LXI:CLOCK:SYNC:LOCAL:INTERVAL
:LXI:CLOCK:SYNC:LOCAL:INTERVAL?

Example: :LXI:CLOC:SYNC:LOC:INT 60

Preset: Not affected by a Preset. The default value of "60" can be restored by using the command:

SYSTem:DEFault INPut

Min: 0

Max: 3600

Instrument S/W Revision: Prior to A.02.00

Instrument Status Events

Enable (Remote Only) Setting the enabled parameter to ON enables the selected instrument event to be used as a source for Output LAN Events. Enabling an Instrument Status Event also causes the event to appear in the Event Log.

Remote Command: :LXI:EVENT:STATUS[:ENABLED] "STATUSEVENT",ON|OFF|1|0

Example: :LXI:EVEN:STAT "WaitingForTrigger",1

Preset: Not affected by a Preset. The default value of "1" can be restored by using the command, :SYSTem:DEFault INPut.

State Saved: Saved in instrument state.

Range: 1|0|ON|OFF

Instrument S/W Revision: Prior to A.02.00

Remote Command: :LXI:EVENT:STATus[:ENABled]? "STATUSEVENT"
 Example: :LXI:EVEN:STAT? "WaitingForTrigger"
 Returns 1 if previously enabled. Otherwise, returns 0.
 Preset: ON
 State Saved: Saved in instrument state.
 Range: 1|0|ON|OFF
 Instrument S/W Revision: Prior to A.02.00

LXI State Recall

Location (Remote Only) This parameter is used to store the file paths of the state files to be recalled when each Input LAN Event is received. Since each LAN Event has its own Location entry, a given state is capable of branching to at least 8 different states. If custom Input events are added, an even greater branching factor is possible.

When setting up state transitions, it is important to set the location of the next state before saving. This way, when the saved state is recalled, the next state locations are also automatically recalled.

Remote Command: :LXI:EVENT:INPut:LAN:LOCation "LANEVENT", "path"
 Example: :LXI:EVEN:INP:LAN:LOC "LANEVENT", "c:\states\state01.state"
 Restriction and Notes: The maximum length of the string is 512 characters.
 State Saved: Saved in instrument state.
 Range: Uppercase, Lowercase, Numeric, Symbol
 Instrument S/W Revision: Prior to A.02.00

Remote Command: :LXI:EVENT:INPut:LAN:LOCation? "LANEVENT"
 Example: :LXI:EVEN:INP:LAN:LOC? "LANEVENT"
 Returns "c:\states\state01.state" if that value was previously entered
 Restriction and Notes: The maximum length of the string is 512 characters.
 State Saved: Saved in instrument state.
 Range: Uppercase, Lowercase, Numeric, Symbol
 Instrument S/W Revision: Prior to A.02.00

Disable All (Remote Only) Causes all LXI Input LAN Events to go into the disabled state (Enabled = OFF).

Remote Command: :LXI:EVENT:INPut:LAN:DISable:ALL
 Example: :LXI:EVEN:INP:LAN:DIS:ALL

System Functions System

Instrument S/W Revision: Prior to A.02.00

Add (Remote Only) Adds the provided string to the list of possible LAN events to Input as a response to instrument events. As new LAN events are added, keys are generated in the LXI Input LAN Events menu. New key panels are generated as the number of possible LAN events increases past a multiple of six, and the “More” keys are updated to reflect the new number of key panels in the LXI Input LAN Events menu.

Remote Command: :LXI:EVENT:INPut:LAN:ADD "LANEVENT"

Example: :LXI:EVEN:INP:LAN:ADD "LANEVENT"

Restriction and Notes: The maximum length of the string is 16 characters.
Longer strings are concatenated and added to the LXI Input LAN Event list.
No event is added if the LAN Event already exists.

State Saved: No

Range: Uppercase, Lowercase, Numeric, Symbol except for comma or semicolon

Instrument S/W Revision: Prior to A.02.00

Remove (Remote Only) Removes the provided string from the list of LXI Input LAN Events. As new LAN events are removed, keys are removed from the LXI Input LAN Events menu. Key panels are removed as the number of possible LAN events decreases past a multiple of six, and the “More” keys are updated to reflect the new number of key panels in the LXI Input LAN Events menu. Events from the default list cannot be removed.

Remote Command: :LXI:EVENT:INPut:LAN:REMOve[:EVENT] "LANEVENT"

Example: :LXI:EVEN:INP:LAN:REM "LANEVENT"

Restriction and Notes: The maximum length of the string is 16 characters.
Longer strings are concatenated and the resulting LAN Event is removed from the LXI Input LAN Event list.
Nothing happens if the LAN event was not introduced using the Add command.

State Saved: No

Range: Uppercase, Lowercase, Numeric, Symbol

Instrument S/W Revision: Prior to A.02.00

Remove All (Remote Only) Clears the list of custom LAN events (those introduced using the Add command). As new LAN events are removed, keys are removed from the LXI Input LAN Events menu. Key panels are removed as the number of possible LAN events decreases past a multiple of six, and the “More” keys are updated to reflect the new number of key panels in the LXI Input LAN Events menu.

Remote Command: :LXI:EVENT:INPut:LAN:REMOve:ALL

Example: :LXI:EVENT:INP:LAN:REM:ALL

Restriction and Notes: Only LAN Events added with the Add command are removed. Default events cannot be removed.

Instrument S/W Revision: Prior to A.02.00

Filter (Remote Only) Only LXI Input LAN Events coming from hosts matching the filter string are processed. There is no Key Path to this command

The syntax for specifying a filter is as follows:

Filter == ([host[:port]] | [ALL[:port]]) [,Filter]

Specifying an empty string means that LXI trigger packets are accepted as an Input from any port on any host on the network via either TCP or UDP.

Specifying only the port means that any host communicating over that port can send events.

Specifying ALL indicates that UDP multicast packets are accepted if they are directed to the IANA assigned multicast address on the IANA assigned default port, or the designated port if specified.

Examples:

- “192.168.0.1:23”
- “agilent.com, soco.agilent.com”
- “agilent.com:80, 192.168.0.1”

Remote Command: :LXI:EVENT:INP:LAN:FILTer "LANEVENT", "filterString"
:LXI:EVENT:INP:LAN:FILTer?

Example: :LXI:EVENT:INP:LAN:FILT "LAN0", "agilent.com"
:LXI:EVENT:INP:LAN:FILT?

Restriction and Notes: The maximum length of the string is 45 characters. Nothing happens if the LAN event does not exist.

State Saved: Saved in instrument state.

Range: Uppercase, Lowercase, Numeric, Symbol

Instrument S/W Revision: Prior to A.02.00

Identifier (Remote Only) Sets the string that is expected to arrive over the LAN for a given Input LAN Event to occur. The Identifier is variable to allow for easier system debugging.

Remote Command: :LXI:EVENT:INP:LAN:IDENtifier "LANEVENT", "identifier"
:LXI:EVENT:INP:LAN:IDENtifier? "LANEVENT"

Example: :LXI:EVENT:INP:LAN:IDEN "LAN0", "debugstring"

System Functions

System

Restriction and Notes:	The maximum length of the string is 16 characters. Nothing happens if the LAN event does not exist. The default value is that the identifier is equivalent to the name of the LAN Event.
State Saved:	Saved in instrument state.
Range:	Uppercase, Lowercase, Numeric, Symbol
Instrument S/W Revision:	Prior to A.02.00

Detection (Remote Only) Pressing this button brings up the Detection menu.

- Selecting “Rise” causes the instrument to trigger on the receipt of a signal low LAN Event followed by a signal high LAN Event.
- Selecting “Fall” causes the instrument to trigger on the receipt of a signal high LAN Event followed by a signal low LAN Event.
- Selecting “High” causes the instrument to trigger on every signal high LAN Event.
- Selecting “Low” causes the instrument to trigger on every signal low LAN Event.

Remote Command:	:LXI:EVENT:INPut:LAN[:SET]:DETection "LANEVENT", HIGH LOW RISE FALL
Example:	:LXI:EVENT:INP:LAN:DET "LANEVENT",HIGH
Restriction and Notes:	If a non existent LAN event is passed in the lanEvent argument, the command is ignored
Preset:	Not affected by a Preset. The default value of "HIGH" can be restored by using the remote command: :SYSTem:DEFault INPut
State Saved:	Saved in instrument state.
Range:	HIGH LOW RISE FALL
Instrument S/W Revision:	Prior to A.02.00

Remote Command:	:LXI:EVENT:INPut:LAN[:SET]:DETection? "LANEVENT"
Example:	:LXI:EVENT:INP:LAN:DET? "LANEVENT"
Restriction and Notes:	If a non existent LAN event is passed in the lanEvent argument, the command is ignored
Preset:	HIGH
State Saved:	Saved in instrument state.
Range:	HIGH LOW RISE FALL
Instrument S/W Revision:	Prior to A.02.00

Enabled (Remote Only) When the Enabled parameter is set to ON, receiving the given LAN Event causes the instrument to transition to the state held in the Next State Slot.

When the Enabled parameter is OFF, the Input LAN Event is ignored.

Remote Command: : LXI : EVENT : INPut : LAN[: SET] : ENABled
 "LANEVENT" , ON | OFF | 1 | 0

Example: : LXI : EVEN : INP : LAN : ENAB "LAN0", 1

Preset: Not affected by a Preset. The default value of "OFF" can be restored by using the remote command:
 : SYSTem : DEFault INPut

State Saved: Saved in instrument state.

Range: 1|0

Instrument S/W Revision: Prior to A.02.00

Remote Command: : LXI : EVENT : INPut : LAN[: SET] : ENABled? "LANEVENT"

Example: : LXI : EVEN : INP : LAN : ENAB? "LAN0"

Preset: OFF

State Saved: Saved in instrument state.

Range: 1|0

Instrument S/W Revision: Prior to A.02.00

Count (Remote Only) Returns the number of items in the LXI Input LAN Event List.

Remote Command: : LXI : EVENT : INPut : LAN : COUNT?

Example: : LXI : EVEN : INP : LAN : COUN?

Instrument S/W Revision: Prior to A.02.00

List (Remote Only) Returns a list of all of the valid LXI Input LAN Event names.

Remote Command: : LXI : EVENT : INPut : LAN : LIST?

Example: : LXI : EVEN : INP : LAN : LIST?
 Returns "LAN0", "LAN1", "LAN2", "LAN3", "LAN4", "LAN5", "LAN6",
 "LAN7"

Preset: "LAN0", "LAN1", "LAN2", "LAN3", "LAN4", "LAN5", "LAN6", "LAN7"

State Saved: Saved in instrument state.

Instrument S/W Revision: Prior to A.02.00

Configure (Remote Only) Allows the configuration of some of the above parameters from a single

SCPI command.

Remote Command: : LXI:EVENT:INPut:LAN[:SET]:CONFigure "lanEvent",
 <enab>, <detection>, <filter>, <identifier>

Example: : LXI:EVEN:INP:LAN:CONF "LAN0",1,FALL,"FILTER","DEBUG"

Instrument S/W Revision: Prior to A.02.00

Restore Defaults

Provides incremental initialization of the system setting groups along with supporting a comprehensive reset of the entire instrument back to a factory default state. The menu selections are the groups of system settings and when one is selected, that particular group of system settings is reset back to their default values.

Key Path	System
Mode	All
Remote Command	: SYSTem:DEFault [ALL] ALIGn INPut MISC MODes PON
Example	SYST:DEF
State Saved	No
Instrument S/W Revision	Prior to A.02.00

Restore Input/Output Defaults

Causes the group of settings and data associated with Input/Output front-panel key to be a reset to their default values. This level of Restore System Defaults does not affect any other system settings, mode settings and does not cause a mode switch.

Confirmation is required to restore the Input/Output setting. The confirmation dialog is:

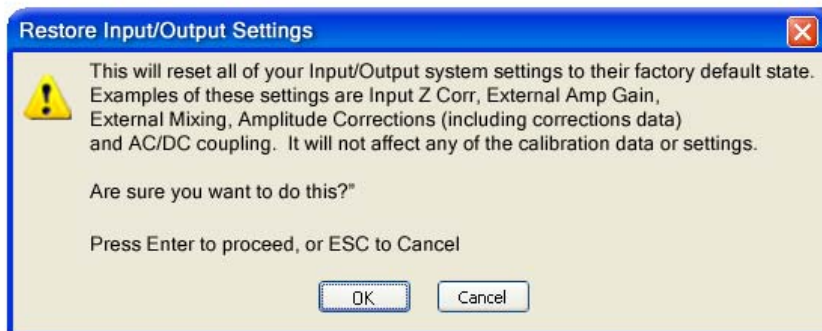

Key Path	System, Restore System Defaults
Example	:SYST:DEF INP

Instrument S/W Revision

Prior to A.02.00

Restore Power On Defaults

This selection causes the Power On settings to be a reset to their default value. This level of Restore System Defaults does not affect any other system settings, mode settings and does not cause a mode switch. The Power On settings and their default values are Power On Type reset to Mode and Input/Output Defaults and Power On Application reset to whatever the factory set as its default value.

Confirmation is required to restore the factory default values. The confirmation dialog is:

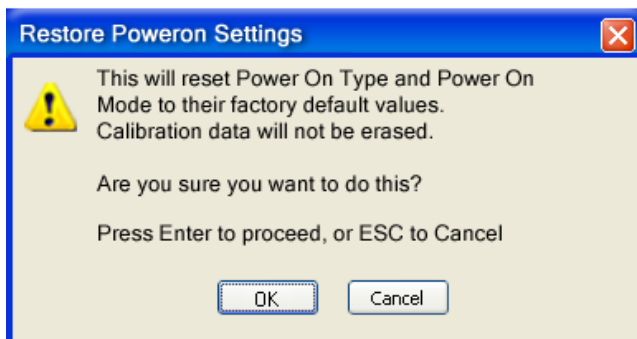

Key Path

System, Restore System Defaults

Example

:SYST:DEF PON

Instrument S/W Revision

Prior to A.02.00

Restore Align Defaults

This selection causes the Alignment system settings to be a reset to their default values. This does not affect any Alignment data stored in the system. This level of Restore System Defaults does not affect any other system settings, mode settings and does not cause a mode switch.

After performing this function, it may impact the auto-alignment time of the instrument until a new alignment baseline has been established.

Confirmation is required to restore the factory default values. The confirmation dialog is:

System Functions System

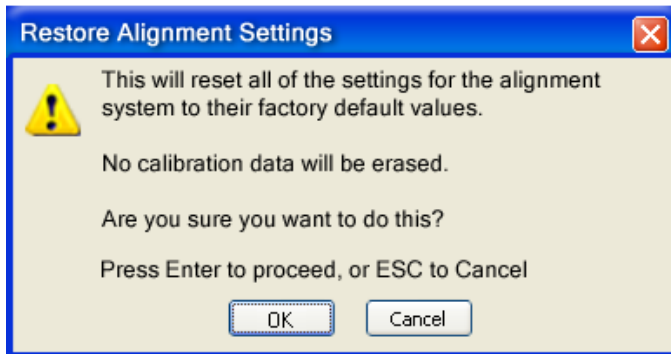

Key Path	System, Restore System Defaults
Example	:SYST:DEF ALIG
Instrument S/W Revision	Prior to A.02.00

Restore Misc Defaults

This selection causes miscellaneous system settings to be reset to their default values. With this reset, you lose the GPIB address and it is reset to 18, so this should be used with caution. This level of Restore System Defaults does not affect any other system settings, mode settings and does not cause a mode switch. This miscellaneous group contains the rest of the settings that have not been part of the other Restore System Defaults groups. The following table is a complete list of settings associated with this group:

Miscellaneous Setting	Default Value
Verbose SCPI	Off
GPIB Address	18
Auto File Name Number	000
Save Type	State
State Save To	Register 1
Screen Save To	SCREEN000.png
DISP:ENABle	ON
Full Screen	Off
SCPI Telnet	ON
SCPI Socket	ON
SICL Server	ON

Display Intensity	100
Display Backlight	ON
Display Theme	TDColor
System Annotation	ON
The SYST:PRES:TYPE	MODE

Confirmation is required to restore the factory default values. The confirmation dialog is:

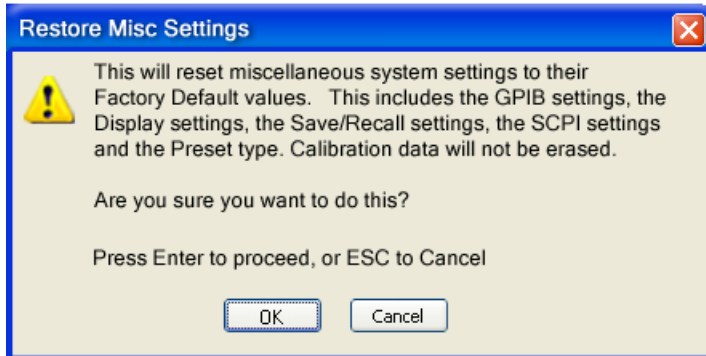

Key Path	System, Restore System Defaults
Example	:SYST:DEF MISC
Instrument S/W Revision	Prior to A.02.00

Restore Mode Defaults (All Modes)

This selection resets all of the modes in the instrument back to their default state just as a Restore Mode Defaults does and it switches the instrument to the power-on mode and causes the default measurement for the power-on mode to be active. This level of Restore System Defaults does not affect any system settings, but it does affect the state of all modes and does cause a mode switch unless the instrument was already in the power-on mode.

Confirmation is required to restore the factory default values. The confirmation dialog is:

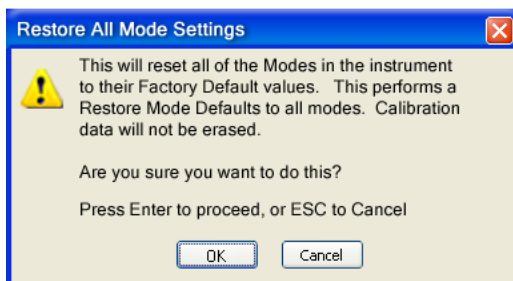

System Functions

System

Key Path	System, Restore System Defaults
Example	:SYST:DEF MOD
Dependencies/Couplings	An All Mode will cause the currently running measurement to be aborted, mode switch to the power-on mode and activate the default measurement for the power-on mode. It gets the mode to a consistent state with all of the default couplings set.
Instrument S/W Revision	Prior to A.02.00

All

This is the catastrophic function that does a comprehensive reset of ALL analyzer settings to their factory default values. It resets all of the system setting groups, causes a Restore Mode Defaults for all modes in the instrument, and switches back to the power-on mode. It does not affect the User Preset file or any user saved files.

Confirmation is required to restore the factory default values. The confirmation dialog is:

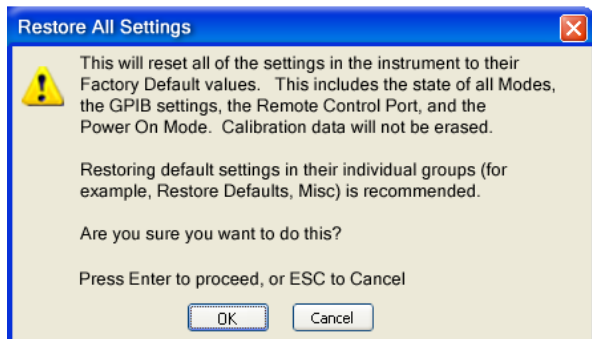

Key Path	System, Restore System Defaults
Example	:SYST:DEF ALL
Dependencies/Couplings	An All will cause the currently running measurement to be aborted and get all modes to a consistent state, so it is unnecessary to couple any settings.
Instrument S/W Revision	Prior to A.02.00

Control Panel...

Opens the Windows Control Panel.

Pressing any key will cause the Control Panel to exit.

Key Path	System
----------	---------------

Remote Command Notes No remote command for this key.
Instrument S/W Revision Prior to A.02.00

Licensing...

Opens the license explorer.

For Help on this key, select Help in the menu bar at the top of the license explorer window.

Key Path **System**
Remote Command Notes No equivalent remote command for this key.
Instrument S/W Revision Prior to A.02.00

There are five remote commands available for licensing.

Remote Command: :SYSTem:LKEY <"OptionInfo">, <"LicenseInfo">
Example: SYST:LKEY
 "N9073A-1FP","027253AD27F83CDA5673A9BA5F427FDA5E4F25AEB1
 017638211AC9F60D9C639FE539735909C551DE0A91"
Remote Command Notes: The <"OptionInfo"> contains the feature and the version. You must specify
 the feature but can omit the version. If you omit the version, the system
 regards it as the latest one, since the system knows which version is supported
 for each feature.
 The <"LicenseInfo"> contains the signature, the expiration date, and serial
 number for transport if transportable. You must specify the signature, but you
 can omit the other information. If you omit the expiration date, the system
 regards it as permanent. If you omit the serial number, the system regards it as
 non-transportable. As a result, this supports backward compatibility.
Instrument S/W Revision: Prior to A.02.00
Remote Command: :SYSTem:LKEY:DELeTe <"OptionInfo">,<"LicenseInfo">
Example: SYST:LKEY:DEL
 "N9073A-1FP","027253AD27F83CDA5673A9BA5F427FDA5E4F25AEB1
 017638211AC9F60D9C639FE539735909C551DE0A91"
Remote Command Notes: The <"OptionInfo"> contains the feature and the version. You must specify
 the feature but can omit the version. If you omit the version, the system
 regards it as the latest one, if more than one version is installed.
 The <"LicenseInfo"> contains the signature, the expiration date, and whether
 or not be transportable. You must specify the signature, but you can omit the
 other information. If you omit the expiration date, the system regards it as
 permanent. If you omit the transportability, the system regards it as
 non-transportable. As a result, this supports backward compatibility.
Instrument S/W Revision: Prior to A.02.00

System Functions

System

Remote Command:	:SYSTem:LKEY:LIST?
Remote Command Notes:	<p>Return Value:</p> <p>An <arbitrary block data> of all the installed instrument licenses.</p> <p>The format of each license is as follows.</p> <p><Feature>,<Version>,<Signature>,<Expiration Date>,<Serial Number for Transport></p> <p>Return Value Example:</p> <p>#3136</p> <p>N9073A-1FP,1.000,B043920A51CA</p> <p>N9060A-2FP,1.000,4D1D1164BE64</p> <p>N9020A-508,1.000,389BC042F920</p> <p>N9073A-1F1,1.000,5D71E9BA814C,13-aug-2005</p> <p><arbitrary block data> is:</p> <p>#NMMM<data></p> <p>Where:</p> <p>N is the number of digits that describes the number of MMM characters. For example if the data was 55 bytes, N would be 2.</p> <p>MMM would be the ASCII representation of the number of bytes. In the previous example, N would be 55.</p> <p><data> ASCII contents of the data</p>
Instrument S/W Revision:	Prior to A.02.00
Remote Command:	:SYSTem:LKEY? <"OptionInfo">
Example:	SYST:LKEY? "N9073A-1FP"
Remote Command Notes:	<p>The <"OptionInfo"> contains the feature and the version. You must specify the feature but can omit the version. If you omit the version, the system regards it as the latest one.</p> <p>Return Value:</p> <p><"LicenseInfo"> if the license is valid, null otherwise.</p> <p><"LicenseInfo"> contains the signature, the expiration date, and serial number if transportable.</p> <p>Return Value Example:</p> <p>"B043920A51CA"</p>
Instrument S/W Revision:	Prior to A.02.00
Remote Command:	:SYSTem:HID?
Remote Command Notes:	Return value is the host ID as a string

Instrument S/W Revision: Prior to A.02.00

Agilent Upgrade Service

The Agilent Upgrade Service entitles an instrument to software enhancements, if and when they occur, for the duration of the service period. Beginning in September, 2008, all new X-Series instruments will contain 2 years of upgrade service included with the purchase of the instrument. The Agilent Upgrade Service will be option AUS on the N9010A or N9020A. For new instrument purchases the two year entitlement will be from date of manufacture (plus one month for transit and receiving).

The Agilent Upgrade Service is administered via a license which carries the end date of the upgrade entitlement. The license can be viewed in Agilent License Manager, or via the Show System screen.

The Agilent Upgrade Service is for an individual instrument, it cannot be transferred from one instrument to another.

For existing instruments that do not have the Agilent Upgrade Service, or for extending the upgrade service after it has expired, the Agilent Upgrade Service is available as a standalone upgrade product. The two year entitlement will be from the date of redemption of the license.

Agilent Upgrade Service - software update installation

When a software update is being performed on an instrument, the installer will determine if the instrument has a valid Agilent Upgrade Service for the revision of software that is being installed. If the Agilent Upgrade Service is valid, the installation proceeds unencumbered. If the service is not valid, the operator is provided a prompt to contact Agilent for purchasing an Agilent Upgrade Service and the software update is not performed.

Agilent Upgrade Service - software removal

When a software update is being removed from instrument via Add/Remove Programs, the uninstall will check if there is an AUS license with date remaining on the service. If the AUS is expired, the operator will be given a prompt warning that an AUS Renewal may be required to install newer software and how to contact Agilent to obtain the renewal. The operator can choose to proceed with uninstall or terminate at which no software will be removed or altered.

Agilent Upgrade Service - viewing end-of-service date

There are two methods for viewing the end-of-service date of the Agilent Upgrade Service. The first is to use the Show System screen in the instrument application System -> Show -> System. The second is to use the Agilent License Manager. The Agilent License Manager can be invoked from the System menu of the instrument application or by right-mouse clicking on the License Notifier icon in the Windows® task tray.

Agilent Upgrade Service - Listing end-of-service date (Remote command only) The end-of-service date for the Agilent Upgrade Service can be queried via SCPI.

Remote Command: :SYSTem:AUService:DATE?

Example: :SYST:AUS:DATE?

System Functions

System

Notes: If there is no Agilent Upgrade Service license installed the date will return "01-sep-2008"

Instrument S/W Revision: A.02.00

Service

Accesses capabilities performed in the factory or under instructions from repair procedures. This menu key is only visible when the logged-in user is "advanceduser" or "saservice". The first access to the Service Menu after invoking the instrument application will require an authentication Service Code.

Key Path **System**
Instrument S/W Revision Prior to A.02.00

Diagnostics

The Diagnostics key in the System menu gives you access to basic diagnostic capabilities of the instrument.

Key Path **System, More**
Instrument S/W Revision Prior to A.02.00

Show Hardware Statistics

Provides a display of various hardware statistics. The statistics include the following:

Mechanical relay cycles

High and Low temperature extremes

Elapsed time that the instrument has been powered-on (odometer)

The display should appear listing the statistics, product number, serial number, and firmware revision.

Std Header	Product Number: N9020A Serial Number: US46340924 Firmware Revision: A.01.01																		
Mechanical relays	<table> <tr> <td>Calibrator Switch Cycles:</td> <td>1800</td> </tr> <tr> <td>AC/DC Switch Cycles:</td> <td>60</td> </tr> <tr> <td>2 dB #1 Mechanical Atten Cycles</td> <td>23489</td> </tr> <tr> <td>2 dB #2 Mechanical Atten Cycles</td> <td>23400</td> </tr> <tr> <td>6 dB Mechanical Atten Cycles</td> <td>500000</td> </tr> <tr> <td>10 dB Mechanical Atten Cycles</td> <td>1000000</td> </tr> <tr> <td>20 dB Mechanical Atten Cycles</td> <td>2500</td> </tr> <tr> <td>30 dB Mechanical Atten Cycles</td> <td>60000</td> </tr> <tr> <td></td> <td>4339</td> </tr> </table>	Calibrator Switch Cycles:	1800	AC/DC Switch Cycles:	60	2 dB #1 Mechanical Atten Cycles	23489	2 dB #2 Mechanical Atten Cycles	23400	6 dB Mechanical Atten Cycles	500000	10 dB Mechanical Atten Cycles	1000000	20 dB Mechanical Atten Cycles	2500	30 dB Mechanical Atten Cycles	60000		4339
Calibrator Switch Cycles:	1800																		
AC/DC Switch Cycles:	60																		
2 dB #1 Mechanical Atten Cycles	23489																		
2 dB #2 Mechanical Atten Cycles	23400																		
6 dB Mechanical Atten Cycles	500000																		
10 dB Mechanical Atten Cycles	1000000																		
20 dB Mechanical Atten Cycles	2500																		
30 dB Mechanical Atten Cycles	60000																		
	4339																		
	<table> <tr> <td>High operating temperature extreme:</td> <td>+37.2degC</td> </tr> <tr> <td>Low operating temperature extreme</td> <td>+18.1degC</td> </tr> </table>	High operating temperature extreme:	+37.2degC	Low operating temperature extreme	+18.1degC														
High operating temperature extreme:	+37.2degC																		
Low operating temperature extreme	+18.1degC																		
Odometer	Elapsed Time (on time) (hours): 1600																		

The data will be updated only when the Show Hardware Statistics menu key is pressed, it will not be updated while the screen is displayed.

The tabular data should be directly printable.

Key Path	System, Diagnostics
Mode	All
Restriction and Notes	The values displayed on the screen are only updated upon entry to the screen and not updated while the screen is being displayed.
Instrument S/W Revision	Prior to A.02.00

Query the Mechanical Relay Cycle Count Returns the count of mechanical relay cycles.

Remote Command:	:SYSTem:MRELay:COUNT?
Example:	:SYST:MREL:COUN?
Remote Command Notes:	Query Only

System Functions

System

Restriction and Notes: The return value is a comma separated list of the individual counts for each mechanical relay.

The position of the relays in the list is:

“<Cal Signal>,<AC/DC>,<2dB #1 Atten>,<2dB #2 Atten>,<6dB Atten>,<10dB Atten>,<20dB Atten>,<30dB Atten>”

Instrument S/W Revision: Prior to A.02.00

Query the Operating Temperature Extremes Returns the low operating temperature extreme value. The value survives a power-cycle and is the temperature extreme encountered since the value was reset by the factory or service center.

Mode All

Remote Command :SYSTem:TEMPerature:LEXTreme?

Example :SYST:TEMP:LEXT?

Restriction and Notes Value is in degrees Celsius at which the lowest operating temperature has been recorded since 1st power-up.

State Saved No

Instrument S/W Revision Prior to A.02.00

Returns the high operating temperature extreme value. The value survives a power-cycle and is the temperature extreme encountered since the value was reset by the factory or service center.

Mode All

Remote Command :SYSTem:TEMPerature:HEXTreme?

Example :SYST:TEMP:HEXT?

Restriction and Notes Value is in degrees Celsius at which the highest operating temperature has been recorded since 1st power-up.

State Saved No

Instrument S/W Revision Prior to A.02.00

Query the Elapsed Time since 1st power on Returns the elapsed on-time in minutes since 1st power-on.

Remote Command: :SYSTem:PON:ETIMe?

Example: :SYST:PON:ETIM?

Remote Command Notes: Query Only

Instrument S/W Revision: Prior to A.02.00

Advanced

Accesses advanced diagnostic capabilities performed in the factory or under instructions from repair procedures. This menu key is only visible when the logged-in user is “saservice”. The first access to the Advanced Diagnostic Menu after invoking the instrument application will require an authentication, which is to enter the Service Code. Subsequent accesses to the Advanced Diagnostic Menu are unimpeded. The Authentication dialog looks like:

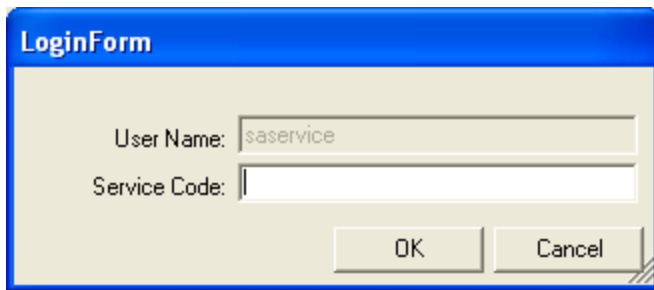

“OK” is the default key thus the Enter key is used to complete the entry. If invalid Service Code is entered authentication is not granted and you are provided the following dialog:



Key Path	System, Diagnostics
Restriction and Notes	Password is required to access this menu.
Instrument S/W Revision	Prior to A.02.00

List installed Options (Remote Command Only)

Lists the installed options that pertain to the instrument (signal analyzer).

Mode	All
Remote Command	:SYSTem:OPTions?
Example	:SYST:OPT?
Restriction and Notes	The return string is a comma separated list of the installed options. For example: “503,P03,PFR” :SYSTem:OPTions? and *OPT? are the same.
State Saved	No

Instrument S/W Revision Prior to A.02.00

Lock the Front-panel keys (Remote Command Only)

Disables the instrument keyboard to prevent local input when the instrument is controlled remotely. Annunciation showing a “K” for ‘Klock’ (keyboard lock) alerts the local user that the keyboard is locked. Klock is similar to the GPIB Local Lockout function; namely that no front-panel keys are active with the exception of the Power Standby key. (The instrument is allowed to be turned-off if Klock is ON.) The Klock command is used in remote control situations where Local Lockout cannot be used.

Although primary intent of Klock is to lock-out the front panel, it will lock-out externally connected keyboards through USB. Klock has no effect on externally connected pointing devices (mice).

The front panel ‘Local’ key (Cancel/Esc) has no effect if Klock is ON.

Mode	All
Remote Command	:SYSTem:KLOCK OFF ON 0 1 :SYSTem:KLOCK?
Example	:SYST:KLOC ON
Remote Command Notes	Keyboard lock remains in effect until turned-off or the instrument is power-cycled
Preset	Initialized to OFF at startup, unaffected by Preset
State Saved	No
Instrument S/W Revision	Prior to A.02.00

List SCPI Commands (Remote Command Only)

Outputs a list of the valid SCPI commands for the currently selected Mode.

Remote Command:	:SYSTem:HELP:HEADers?
Example:	:SYST:HELP:HEAD?
Remote Command Notes:	The output is an IEEE Block format with each command separated with the New-Line character (hex 0x0A)
Instrument S/W Revision:	Prior to A.02.00

SCPI Version Query (Remote Command Only)

Returns the SCPI version number with which the instrument complies. The SCPI industry standard changes regularly. This command indicates the version used when the instrument SCPI commands were defined.

Remote Command:	:SYSTem:VERsion?
-----------------	------------------

Example: :SYST:VERS?
Instrument S/W Revision: Prior to A.02.00

Date (Remote Command Only)

The recommended access to the Date, Time, and Time zone of the instrument is through the Windows native control (Control Panel or accessing the Task Bar). You may also access this information remotely, as shown in this command and Time (below).

Sets or queries the date in the instrument.

Mode All
Remote Command :SYSTem:DATE "<year> , <month> , <day>"
:SYSTem:DATE?
Example :SYST:DATE "2006,05,26"
Remote Command Notes <year> is the four digit representation of year. (for example, 2006)
<month> is the two digit representation of year. (for example. 01 to 12)
<day> is the two digit representation of day. (for example, 01 to 28, 29, 30, or 31) depending on the month and year
Instrument S/W Revision Prior to A.02.00

Time (Remote Command Only)

Sets or queries the time in the instrument.

Mode All
Remote Command :SYSTem:TIME "<hour> , <minute> , <second>"
:SYSTem:TIME?
Example :SYST:TIME "13,05,26"
Remote Command Notes <hour> is the two digit representation of the hour in 24 hour format
<minute> is the two digit representation of minute
<second> is the two digit representation of second
Instrument S/W Revision Prior to A.02.00

User Preset

The User Preset key opens up a menu that gives you three choices – execute the **User Preset** by pressing the **User Preset** key, User Preset all of the modes in the analyzer by pressing the **User Preset All Modes** key, and save the current state for the current mode by pressing the **Save User Preset** key.

Key Path	Front-panel key
Instrument S/W Revision	Prior to A.02.00

User Preset

User Preset behaves similarly to **Recall State** in that it recalls a hidden Save State file. However, since each Mode has its own **User Preset** file, **User Preset** will never cause a mode switch, whereas recalling a Save State file may cause a mode switch, if the Save State file was saved while in a different mode.

The User Preset file is a Save State file. **User Preset** sets the state of the currently active mode back to the state that was previously saved for this mode using the **Save User Preset** menu key or the SCPI command, `SYST:PRES:USER:SAV`. So for any given Mode, the only way to perform a User Preset is from that Mode, not from any other Mode. The user has no control over the user preset filename and has no direct access to the user preset file.

User Preset recalls a mode's state which includes all of the variables affected by doing a Mode Preset. It not only recalls Mode Preset settings, but it also recalls all of the mode persistent settings. User Preset also recalls all of the Input/Output system settings that existed at the time **Save User Preset** was executed.

If a **Save User Preset** has not been done at any time, **User Preset** recalls the default user preset file for the currently active mode. The default user preset files are created if, at power-on, a mode detects there is no user preset file, so there will never be a scenario when there is no user preset file to restore. For each mode, the default user preset state is the same state that would be saved if a **Save User Preset** is performed in each mode right after doing a Restore Mode Default and after a Restore Input/Output Defaults.

User Preset does the following:

- Aborts the currently running measurement.
- Sets the mode state to the values defined by **Save User Preset**.
- Makes the saved measurement for the currently running mode the active measurement.
- Brings up the saved menu for the power-on mode.
- Clears the input and output buffers.
- Sets the Status Byte to 0.
-

Key Path	User Preset
----------	--------------------

Remote Command	:SYSTem:PRESet:USER
Example	:SYST:PRES:USER:SAVE :SYST:PRES:USER
Remote Command Notes	:SYST:PRES:USER:SAVE is used to save the current state as the user preset state.
Restriction and Notes	Clears all pending OPC bits. The Status Byte is set to 0.
Dependencies/Couplings	A user preset will cause the currently running measurement to be aborted and cause the saved measurement to be active. Recalling a User Preset file has the same issues that recalling a Save State file has. Some settings may need to be limited and therefore re-coupled, since the capabilities of the mode may have changes when the User Preset file was last saved.
Instrument S/W Revision	Prior to A.02.00

User Preset All Modes

User Preset All Modes behaves similarly to Power On User Preset, since it recalls all of the User Preset files for each mode, switches to the power-on mode and activates the saved measurement from the power-on mode User Preset file.

NOTE When the instrument is secured, all of the user preset files are converted back to their default user preset files.

User Preset does the following:

- Aborts the currently running measurement.
- Switches the Mode to the power-on mode.
- Restores the User Preset files for each mode.
- Makes the saved measurement for the power-on mode the active measurement.
- Brings up the saved menu for the power-on mode.
- Clears the input and output buffers.
- Sets the Status Byte to 0.
-

Key Path	User Preset
Remote Command	:SYSTem:PRESet:USER:ALL
Example	:SYST:PRES:USER:SAVE :SYST:PRES:USER:ALL
Remote Command Notes	:SYST:PRES:USER:SAVE is used to save the current state as the user preset state.

System Functions

User Preset

Restriction and Notes	Clears all pending OPC bits. The Status Byte is set to 0.
Dependencies/Couplings	A user preset will cause the currently running measurement to be aborted, cause a mode switch to the power-on mode, and cause the saved measurement to be active in the power-on mode. Recalling a User Preset file has the same issues that recalling a Save State file has. Some settings may need to be limited and therefore re-coupled, since the capabilities of the mode may have changes when the User Preset file was last saved.
Instrument S/W Revision	Prior to A.02.00

Save User Preset

Save User Preset saves the currently active mode and its state. The way you recall this User Preset file is by pressing the User Preset menu key or sending the SYST:PRES:USER remote command. This same state is also saved by the Save State function.

Key Path	User Preset
Remote Command	:SYSTem:PRESet:USER:SAVE
Example	:SYST:PRES:USER:SAVE
Restriction and Notes	:SYST:PRES:SAVE creates the same file as if you requested a *SAV or a MMEM:STOR:STAT, except User Preset Save does not allow you to specify the filename or the location of the file.
Instrument S/W Revision	Prior to A.02.00

6 Burst Power (Transmit Power)

The Burst Power (Transmit Power) measurement (at the base transceiver station) is used to determine the power delivered to the antenna system on the radio-frequency channel under test. The Burst Power measurement verifies the accuracy of the mean transmitted RF carrier power. This can be done across the frequency range and at each power step. For more information, see [“Transmit Power \(Burst Power\) Measurement Description” on page 297](#). For measurement results and views, see [“View/Display” on page 343](#).

This topic contains the following sections.

[“Measurement Commands for Burst Power \(Transmit Power\)” on page 295](#)

[“Remote Command Results for Burst Power \(Transmit Power\)” on page 296](#)

Measurement Commands for Burst Power (Transmit Power)

The general functionality of CONFigure, FETCh, MEASure, and READ are described at the beginning of this section. See the SENSE:TXPower|BPOWer commands for more measurement related commands.

NOTE The BPOWer form of the commands is included for backward compatibility only. They are not recommended for use in new designs. Use the TXPower keyword.

The following commands are used to retrieve the measurement results:

```
:CONFigure:TXPower|BPOWer
:CONFigure:TXPower|BPOWer:NDEFault
:INITiate:TXPower|BPOWer
:FETCh:TXPower|BPOWer[n]?
:READ:TXPower|BPOWer[n]?
:MEASure:TXPower|BPOWer[n]?
```

For more remote command information, see the section, [“Remote Measurement Functions” on page 1127](#).

Remote Command Results for Burst Power (Transmit Power)

n	Results Returned
0	Returns unprocessed I/Q trace data, as a series of comma-separated trace points, in volts. The I values are listed first in each pair, using the 0 through even-indexed values. The Q values are the odd-indexed values.
not specified or n = 1	<p>Returns the following comma-separated scalar results:</p> <ol style="list-style-type: none"> 1. Sample time is a floating point number representing the time between samples when using the trace queries (n=0, 2, etc.). 2. Power is the mean power (in dBm) of the power value that calculated by specified method: above the threshold or measured burst width. If averaging is on, the power is for the latest acquisition. 3. Power averaged is the power (in dBm) for N averages, if averaging is on. An average consists of N acquisitions of data which represents the current trace. If averaging is off, the value of Power averaged is the same as the Power value. 4. Number of samples is the number of data points in the captured signal. This number is useful when performing a query on the signal (i.e. when n=0, 2, etc.). 5. Threshold value is the absolute threshold level (in dBm) above which the power is calculated when Meas Method is set to Above Threshold. 6. Threshold points is the number of points that were above the threshold and were used to calculate Mean Transmit Power when “Meas Method” on page 321 is set to Above Threshold. If “Meas Method” on page 321 is set to Measured Burst Width, Measured Pts is returned. 7. Maximum value is the maximum peak level of the most recently acquired trace data (in dBm). 8. Minimum value is the minimum peak level of the most recently acquired trace data (in dBm). 9. Full Burst width is the burst width of this signal regardless of the parameter value set for the current Measured width. The Burst width is determined by the Threshold Lvl when Meas Method is set to Measured Burst Width. If Meas Method is set to Above Threshold Lvl, this value is 0. Full Burst width is the burst width of this signal regardless of the parameter value set for the current Measured width. The Burst width is determined by the Threshold Lvl when Meas Method is set to Measured Burst Width. If Meas Method is set to Above Threshold Lvl, this value is zero. 10. Measured width is the time length that is used to calculate Mean Transmit Power when “Meas Method” on page 321 is set to Measured Burst Width. If “Meas Method” on page 321 is set to Above Threshold, this value is zero. 11. Measured points is the number of points used to calculate Mean Transmit Power when Meas Method is set to Measured Burst Width. If Meas Method is set to Above Threshold, this value is 0.
2	<p>Returns comma-separated trace points of the Measure Trace data.</p> <p>These data points are floating point numbers representing the power of the signal (in dBm). There are N data points, where N is the number of samples. The period between the samples is defined by the sample time.</p>

- 3 Returns comma-separated trace points of the Max Hold Trace data.
- These data points are floating point numbers representing the power of the signal (in dBm). There are N data points, where N is the number of samples. The period between the samples is defined by the sample time.
- * This is not available in TD-SCDMA.
- 4 Returns comma-separated trace points of the Min Hold Trace data.
- These data points are floating point numbers representing the power of the signal (in dBm). There are N data points, where N is the number of samples. The period between the samples is defined by the sample time.
- * This is not available in TD-SCDMA.

Transmit Power (Burst Power) Measurement Description

Mobile stations and base transceiver stations must transmit enough power, with sufficient modulation accuracy, to maintain a call of acceptable quality without leaking power into frequency channels or timeslots allocated for others. The Burst Power measurement determines the average power for an RF signal burst at or above a specified threshold value or during the detected burst width. The threshold value may be absolute, or relative to the peak value of the signal. Burst width can be set automatically or manually.

Key Path	Front-panel key
Instrument S/W Revision	Prior to A.02.00

AMPTD Y Scale

Accesses a menu of functions that enable you to set the vertical scale parameters. Many of the parameter values are measurement dependent. Attenuation values, and the Internal Preamp selection are measurement global, so they are common across all measurements. Functions with operation unique to this measurement are described below. See “[Amplitude Y Scale \(AMPTD Y Scale\)](#)” on page 1037 for more information.

Key Path	Front panel key
Instrument S/W Revision	Prior to A.02.00

Y Ref Value

Sets the absolute power reference.

Key Path	AMPTD Y Scale
Mode	SA, GSM, TD-SCDMA
Remote Command	:DISPlay:TXPower:VIEW[1]:WINDow[1]:TRACe:Y[:SCALE]:RLEV el <real> :DISPlay:TXPower:VIEW[1]:WINDow[1]:TRACe:Y[:SCALE]:RLEV el?
Example	DISP:TXP:VIEW:WIND:TRAC:Y:RLEV 5dbm DISP:TXP:VIEW:WIND:TRAC:Y:RLEV?
Notes	You must be in the Spectrum Analyzer mode, TD-SCDMA mode or GSM mode to use this command. Use INSTRUMENT:SElect to set the mode.
Dependencies/Couplings	When Y Auto Scaling is On, this value is automatically determined by the measurement result. When the user sets this value manually, Y Auto Scaling automatically changes to Off.
Preset	10.00
State Saved	Saved in instrument state.
Min	-250.0
Max	250.0
Instrument S/W Revision	Prior to A.02.00

Attenuation

This menu controls both the electrical and mechanical attenuators and their interactions. The value read back on the key in square brackets is the current Total (Elec + Mech) attenuation. In "Pre-Adjust for Min Clip" this value can change at the start of every measurement.

See “Attenuation” on page 1037 for more information.

Key Path	AMPTD Y Scale
Instrument S/W Revision	Prior to A.02.00

Scale/Division

Enables you to enter a numeric value to change the vertical display sensitivity.

Key Path	AMPTD Y Scale
Mode	SA, GSM, TD-SCDMA
Remote Command	:DISPlay:TXPower:VIEW[1]:WINDow[1]:TRACe:Y[:SCALE]:PDIV ision <rel_ampl> :DISPlay:TXPower:VIEW[1]:WINDow[1]:TRACe:Y[:SCALE]:PDIV ision?
Example	DISP:TXP:VIEW:WIND:TRAC:Y:PDIV 10dB DISP:TXP:VIEW:WIND:TRAC:Y:PDIV?
Notes	You must be in the Spectrum Analyzer mode, TD-SCDMA mode or GSM mode to use this command. Use INSTRUMENT:SELEct to set the mode.
Dependencies/Couplings	When the Y Auto Scaling is On, this value is automatically determined by the measurement result. When the user sets a value manually, Y Auton Scaling automatically changes to Off.
Preset	10.00 dB
State Saved	Saved in instrument state.
Min	0.1 dB
Max	20.00 dB
Instrument S/W Revision	Prior to A.02.00

Presel Center (Measurement Global)

Operation of this key is identical across several measurements. For details about this key, see “Presel Center” on page 1049.

Presel Adjust (Measurement Global)

Operation of this key is identical across several measurements. For details about this key, see “Preselector Adjust” on page 1050.

Internal Preamp

Accesses keys that control the internal preamps. Turning on the preamp gives a better noise figure, but a less desirable TOI to noise floor dynamic range. You can optimize this setting for your particular

Burst Power (Transmit Power) AMPTD Y Scale

measurement.

See “[Internal Preamp](#)” on page 1052 for more information.

Key Path	AMPTD Y Scale
Instrument S/W Revision	Prior to A.02.00

Ref Position

Enables you to set the display reference position to either, Top, Center or Bottom.

Key Path	AMPTD Y Scale, More
Mode	SA, GSM, TD-SCDMA
Remote Command	:DISPlay:TXPower:VIEW[1]:WINDow[1]:TRACe:Y[:SCALE]:RPOS ition TOP CENTer BOTTom :DISPlay:TXPower:VIEW[1]:WINDow[1]:TRACe:Y[:SCALE]:RPOS ition?
Example	DISP:TXP:VIEW:WIND:TRAC:Y:RPOS CENT DISP:TXP:VIEW:WIND:TRAC:Y:RPOS?
Notes	You must be in the Spectrum Analyzer mode, TD-SCDMA mode or GSM mode to use this command. Use INSTRument:SElect to set the mode.
Preset	TOP
State Saved	Saved in instrument state.
Range	Top Ctr Bot
Instrument S/W Revision	Prior to A.02.00

Auto Scaling

Allows you to toggle the Y axis auto scaling function between On and Off.

Key Path	AMPTD Y Scale, More
Mode	SA, GSM, TD-SCDMA
Remote Command	:DISPlay:TXPower:VIEW[1]:WINDow[1]:TRACe:Y[:SCALE]:COUP le 0 1 OFF ON :DISPlay:TXPower:VIEW[1]:WINDow[1]:TRACe:Y[:SCALE]:COUP le?
Example	DISP:TXP:VIEW:WIND:TRAC:Y:COUP 0 DISP:TXP:VIEW:WIND:TRAC:Y:COUP?
Notes	You must be in the Spectrum Analyzer mode, TD-SCDMA mode or GSM mode to use this command. Use INSTRument:SElect to set the mode.

Dependencies/Couplings	When Auto Scaling is On, upon pressing the Restart front-panel key, this function automatically determines the scale per division and reference values based on the measurement results. When the user sets a value either “Y Ref Value” on page 298 or “Scale/Division” on page 299 , this parameter automatically is set to ‘Off’.
Preset	ON
State Saved	Saved in instrument state.
Range	On Off
Instrument S/W Revision	Prior to A.02.00

Auto Couple

Operation of this key is identical across several measurements. For details about this key, see “[AUTO COUPLE](#)” on page 1055.

BW

Accesses a menu of functions that enable you to specify and control the video and resolution bandwidths. You can also select the type of filter for the measurement and set the filter bandwidth.

NOTE If the mode is TD-SCDMA, this function will NOT be available.

Key Path	Front panel key
Mode	SA, GSM
Instrument S/W Revision	Prior to A.02.00

Res BW

Sets the resolution bandwidth. This is the bandwidth used for the power measurement. The bandwidth is ideally wide enough to pass all the power of the bursted signal, while not being so wide that it passes noise that reduces dynamic range and the accuracy of low level measurements.

Key Path	BW
Mode	SA, GSM
Remote Command	[:SENSE]:TXPower:BANDwidth[:RESolution] <bandwidth> [:SENSE]:TXPower:BANDwidth[:RESolution]?
Example	TXP:BAND 1000 TXP:BAND?
Notes	You must be in the Spectrum Analyzer mode or GSM mode to use this command. Use INSTRUMENT:SElect to set the mode.
Preset	GSM: 510 kHz SA: 3 MHz
State Saved	Saved in instrument state.
Min	1 kHz
Max	Hardware Dependent: No Option = 10 MHz Option B25 = 25 MHz
Instrument S/W Revision	Prior to A.02.00

RBW Control

Accesses a menu that enables you to select the filter bandwidth and type.

Burst Power (Transmit Power) BW

Filter Type

Besides the familiar Gaussian filter shape, there are certain special filter types, such as Flat Top, that are desirable under certain conditions.

Key Path	BW
Mode	SA, GSM
Remote Command	[:SENSe]:TXPower:BANDwidth:TYPE GAUSSian FLATtop [:SENSe]:TXPower:BANDwidth:TYPE?
Example	TXP:BAND:TYPE GAUS TXP:BAND:TYPE?
Notes	<p>This chooses the type of filter, either Gaussian or Flat (Flattop). Gaussian is the best choice when looking at the overall burst or the rising and falling edges, as it has excellent pulse response. We are not interested in trading off time domain accuracy vs. noise, just total power accuracy vs. noise level in this measurement. If you want to precisely examine just the useful part of the burst, choose Flat. This is an advanced control that normally does not need to be changed. Setting this to a value other than the factory default, may cause invalid measurement results.</p> <p>FLATtop – a filter with a flat amplitude response, which provides the best amplitude accuracy.</p> <p>GAUSSian – a filter with Gaussian characteristics, which provides the best pulse response.</p> <p>You must be in the Spectrum Analyzer mode or GSM mode to use this command. Use INSTRument:SElect to set the mode.</p>
Preset	GAUSSian
State Saved	Saved in instrument state.
Range	Gaussian (Normal) Flattop
Instrument S/W Revision	Prior to A.02.00

Cont (Continuous)

Operation of this key is identical across several measurements. For details about this key, see “[Cont \(Continuous Measurement/Sweep\)](#)” on page 1059.

FREQ/Channel (Frequency or Channel)

Operation of this key is identical across several measurements. For details about this key, see “Frequency/Channel” on page 1061.

Input/Output

Operation of this key is identical across several measurements. For details about this key, see “Input/Output” on page 1065.

Marker

Accesses a menu that enables you to select, set up and control the markers for the current measurement.

For more information, see “Marker” on page 1123.

Key Path	Front panel key
Instrument S/W Revision	Prior to A.02.00

Select Marker

Displays 12 markers available for selection.

Key Path	Marker
Instrument S/W Revision	Prior to A.02.00

Marker Type

Sets the marker control mode as described under **Normal**, **Delta**, **Fixed** and **Off**, below. All interactions and dependencies detailed under the key description are enforced when the remote command is sent.

Key Path	Marker
Mode	GSM, SA, TD-SCDMA
Remote Command	:CALCulate:TXPower:MARKer[1] 2 3 4 5 6 7 8 9 10 11 12:MODE POSITION DELTA OFF :CALCulate:TXPower:MARKer[1] 2 3 4 5 6 7 8 9 10 11 12:MODE?
Example	CALC:TXP:MARK:MODE OFF CALC:TXP:MARK:MODE?
Notes	If the selected marker is Off, pressing Marker sets it to Normal and places it at the center of the screen on the trace determined by the Marker Trace rules. At the same time, Marker X Axis Value appears on the Active Function area. Default Active Function: the active function for the selected marker’s current control mode. If the current control mode is Off, there is no active function and the active function is turned off. Active Function Display: the marker X axis value entered in the active function area will display the marker value to its full entered precision. You must be in the Spectrum Analyzer mode, TD-SCDMA mode or GSM mode to use this command. Use INSTRUMENT:SElect to set the mode.
Preset	OFF
State Saved	Saved in instrument state.

Range	Normal Delta Off
Instrument S/W Revision	Prior to A.02.00

Marker X Axis Value

Sets the marker X Axis value in the current marker X Axis Scale unit. It has no effect if the control mode is **Off**, but is the SCPI equivalent of entering an X value if the control mode is **Normal** or **Delta**.

Key Path	Marker, Normal
Mode	GSM, SA, TD-SCDMA
Remote Command	:CALCulate:TXPower:MARKer[1] 2 3 4 5 6 7 8 9 10 11 12:X <real> :CALCulate:TXPower:MARKer[1] 2 3 4 5 6 7 8 9 10 11 12:X ?
Example	CALC:TXP:MARK3:X 0 CALC:TXP:MARK3:X?
Notes	If no suffix is sent, it will use the fundamental units for the current marker X Axis Scale. If a suffix is sent that does not match the current marker X Axis Scale unit, an error “Invalid suffix” will be generated. The query returns the marker’s absolute X Axis value if the control mode is Normal , or the offset from the marker’s reference marker if the control mode is Delta . The query is returned in the fundamental units for the current marker X Axis scale: Hz for Frequency and Inverse Time , seconds for Period and Time . If the marker is Off the response is not a number. You must be in the Spectrum Analyzer mode, TD-SCDMA mode or GSM mode to use this command. Use INSTRument:SElect to set the mode.
Dependencies/Couplings	Max value would be changed by Sweep/Meas Time parameter value.
Preset	Markers are turned OFF, so Marker X Axis Value query will return a not a number (NAN).
State Saved	No
Min	-9.9E+37
Max	9.9E+37
Instrument S/W Revision	Prior to A.02.00

Marker X Axis Position (Remote Command Only)

Sets the marker X position in trace points. It has no effect if the control mode is **Off**, but is the SCPI equivalent of entering a value if the control mode is **Normal** or **Delta** except in trace points rather than X Axis Scale units. The entered value is immediately translated into the current X Axis Scale units for

Burst Power (Transmit Power) Marker

setting the value of the marker.

Mode	GSM, SA, TD-SCDMA
Remote Command	:CALCulate:TXPower:MARKer[1] 2 3 4 5 6 7 8 9 10 11 12:X :POSition <real> :CALCulate:TXPower:MARKer[1] 2 3 4 5 6 7 8 9 10 11 12:X :POSition?
Example	CALC:TXP:MARK10:X:POS 500 CALC:TXP:MARK10:X:POS?
Notes	The query returns the marker's absolute X Axis value in trace points if the control mode is Normal , or the offset from the marker's reference marker in trace points if the control mode is Delta . If the marker is Off the response is not a number. You must be in the Spectrum Analyzer mode, TDSCMA mode or GSM mode to use this command. Use INSTRument:SELEct to set the mode.
Dependencies/Couplings	Max value would be changed by Sweep/Meas Time parameter value.
Preset	Markers are turned OFF, so Marker X Axis Value query will return a not a number (NAN).
State Saved	No
Min	-9.9E+37
Max	9.9E+37
Instrument S/W Revision	Prior to A.02.00

Marker Y Axis Value (Remote Command Only)

Returns the marker Y Axis value in the current marker Y Axis unit.

The “result” of a marker is the value which is displayed on the second line of the Marker Result block. To properly interpret the returned value the remote programmer must also know what the analyzer's Y-Axis Unit is set to as described below.

A marker can have up to two results, only one of which is displayed or returned on a query, as follows:

Absolute result: every marker has an absolute result and it is simply:

For Normal and Delta markers, the Y Axis value of the trace point the marker is currently on.

The absolute result is displayed in the result block or returned on a query unless the marker control mode is **Delta**.

Relative result: if a marker's control mode is **Delta**, the relative result is displayed in the result block or returned on a query. This is the ratio of the Absolute Result of a delta marker to the Absolute Result of its reference marker. The ratio is expressed in dB.

Mode	GSM, SA, TD-SCDMA
------	-------------------

Remote Command	:CALCulate:TXPower:MARKer[1] 2 3 4 5 6 7 8 9 10 11 12:Y?
Example	CALC:TXP:MARK11:Y?
Notes	The query returns the marker Y Axis result. If the marker is Off the response is not a number. You must be in the Spectrum Analyzer mode, TD-SCDMA mode or GSM mode to use this command. Use INSTRument:SElect to set the mode.
Preset	0
State Saved	No
Instrument S/W Revision	Prior to A.02.00

Properties

Accesses a menu that enables you to set marker properties and to access the marker trace menu.

Key Path	Marker
Instrument S/W Revision	Prior to A.02.00

Select Marker

Displays 12 markers available for selection.

Key Path	Marker, Properties
Mode	GSM, SA, TD-SCDMA
Instrument S/W Revision	Prior to A.02.00

Relative To

Selects the marker that the selected marker will be relative to (its reference marker).

Key Path	Marker, Properties
Mode	GSM, SA, TD-SCDMA
Remote Command	:CALCulate:TXPower:MARKer[1] 2 3 4 5 6 7 8 9 10 11 12:REFerence <integer> :CALCulate:TXPower:MARKer[1] 2 3 4 5 6 7 8 9 10 11 12:REFerence?
Example	CALC:TXP:MARK:REF 10 CALC:TXP:MARK:REF?

Burst Power (Transmit Power) Marker

Notes	<p>A marker cannot be relative to itself, so that choice is grayed out, and if sent from SCPI generates error -221: “Settings conflict; marker cannot be relative to itself.”</p> <p>You must be in the Spectrum Analyzer mode, TD-SCDMA mode or GSM mode to use this command. Use INSTRUMENT:SElect to set the mode.</p> <p>When queried a single value will be returned (the specified marker numbers relative marker).</p>
Preset	2 3 4 5 6 7 8 9 10 11 12 1
State Saved	Saved in instrument state.
Min	1
Max	12
Instrument S/W Revision	Prior to A.02.00

Marker Trace

Assigns the specified marker to the designated trace.

Key Path	Marker, Properties
Mode	GSM, SA, TD-SCDMA
Remote Command	<pre>:CALCulate:TXPower:MARKer[1] 2 3 4 5 6 7 8 9 10 11 12:TRACe RFENvelope MAXHold MINHold</pre> <pre>:CALCulate:TXPower:MARKer[1] 2 3 4 5 6 7 8 9 10 11 12:TRACe?</pre>
Example	<pre>CALC:TXP:MARK:TRAC MAXH</pre> <pre>CALC:TXP:MARK:TRAC?</pre>
Notes	You must be in the Spectrum Analyzer mode, TD-SCDMA mode or GSM mode to use this command. Use INSTRUMENT:SElect to set the mode.
Dependencies/Couplings	<p>If Detector/Max Hold Trace is Off, Max Hold is grayed out and MAXHold parameter is not available.</p> <p>If Detector/Min Hold Trace is Off, Min Hold is grayed out and MINHold parameter is not available.</p>
Preset	RFENvelope
State Saved	Saved in instrument state.
Range	RF Envelope Max Hold RF Envelope Min Hold RF Envelope
Instrument S/W Revision	Prior to A.02.00

Couple Markers

When this function is true, moving any marker causes an equal X Axis movement of every other marker which is not **Off**. By “equal X Axis movement” we mean that we preserve the difference between each

marker's X Axis value (in the fundamental x-axis units of the trace that marker is on) and the X Axis value of the marker being moved (in the same fundamental x-axis units).

This may result in markers going off screen.

Key Path	Marker, More
Mode	GSM, SA, TD-SCDMA
Remote Command	:CALCulate:TXPower:MARKer:COUPle[:STATe] ON OFF 1 0 :CALCulate:TXPower:MARKer:COUPle[:STATe]?
Example	CALC:TXP:MARK:COUP ON CALC:TXP:MARK:COUP?
Notes	You must be in the Spectrum Analyzer mode, TD-SCDMA mode or GSM mode to use this command. Use INSTRument:SELEct to set the mode.
Preset	OFF
State Saved	Saved in instrument state.
Range	On Off
Instrument S/W Revision	Prior to A.02.00

All Markers Off

Turns off all markers.

Key Path	Marker, More
Mode	GSM, SA, TD-SCDMA
Remote Command	:CALCulate:TXPower:MARKer:AOFF
Example	CALC:TXP:MARK:AOFF
Notes	You must be in the Spectrum Analyzer mode, TDSDMA mode or GSM mode to use this command. Use INSTRument:SELEct to set the mode.
Instrument S/W Revision	Prior to A.02.00

Marker Function

There is no 'Marker Function' supported in Burst (Tx) Power so this front-panel key will display a blank menu key when pressed.

Key Path	Front panel key
Instrument S/W Revision	Prior to A.02.00

Marker To

There is no 'Marker To' functionality supported in Burst (Tx) Power so this front-panel key will display a blank menu key when pressed.

Key Path	Front panel key
Instrument S/W Revision	Prior to A.02.00

Meas

Operation of this key is identical across several measurements. For details about this key, see [“Meas” on page 1127](#).

Meas Setup

Displays the setup menu for the currently selected measurement. Many of the lower-level menu keys operate the same in all measurements. Unique functions are described below. For more information, refer to Analyzer Setup.

Key Path	Front panel key
Instrument S/W Revision	Prior to A.02.00

Avg/Hold Num

Specifies the number of data acquisition that will be averaged. After the specified number of average counts, the averaging mode (terminal control) setting determines the averaging action.

On - Sets measurement averaging on.

Off - Sets measurement averaging off.

Key Path	Meas Setup
Mode	SA, GSM, TD-SCDMA
Remote Command	[:SENSe] :TXPower :AVERage :COUNT <integer> [:SENSe] :TXPower :AVERage :COUNT? [:SENSe] :TXPower :AVERage [:STATe] OFF ON 0 1 [:SENSe] :TXPower :AVERage [:STATe] ?
Example	TXP:AVER:COUN 100 TXP:AVER:COUN? TXP:AVER:0 TXP:AVER?
Notes	You must be in the Spectrum Analyzer mode or GSM mode to use this command. Use INSTRUMENT:SElect to set the mode.
Preset	50 ON
State Saved	Saved in instrument state.
Min	1
Max	10000
Instrument S/W Revision	Prior to A.02.00

Avg Mode

Selects the type of termination control used for the averaging function. This determines the averaging action after the specified number of data acquisitions (average count) is reached.

KEY:Exponential SCPI:EXponential	After the average count is reached, each successive data acquisition is exponentially weighted and combined with the existing average.
KEY:Repeat SCPI:REPeat	After reaching the average count, the averaging is reset and a new average is started.

Key Path	Meas Setup
Mode	SA, GSM, TD-SCDMA
Remote Command	[:SENSe] :TXPower:AVERage:TCONtrol EXPonential REPeat [:SENSe] :TXPower:AVERage:TCONtrol?
Example	TXP:AVER:TCON REP TXP:AVER:TCON?
Notes	You must be in the Spectrum Analyzer mode or GSM mode to use this command. Use INSTRument:SElect to set the mode.
Preset	EXponential
State Saved	Saved in instrument state.
Range	Exp Repeat
Instrument S/W Revision	Prior to A.02.00

Avg Type

Specifies the type of trace and result averaging to use.

KEY:Pwr Avg (RMS) SCPI:RMS	True power averaging that is equivalent to taking the RMS value of the voltage. It is the most accurate type of averaging.
KEY:Log-Pwr Avg (Video) SCPI:LOG	Simulates the traditional spectrum analyzer type of averaging by averaging the log of the power.
KEY:None SCPI:MAXimum	The maximum values are retained during the averaging cycle.
KEY:None SCPI:MINimum	The minimum values are retained during the averaging cycle.

SA, GSM Mode

Key Path	Meas Setup
Mode	SA, GSM
Remote Command	[:SENSe] :TXPower :AVERage :TYPE LOG MAXimum MINimum RMS [:SENSe] :TXPower :AVERage :TYPE ?
Example	TXP:AVER:TYPE LOG TXP:AVER:TYPE ?
Notes	Maximum Minimum are selected only via SCPI. You must be in the Spectrum Analyzer or GSM mode to use this command. Use INSTRument:SElect to set the mode.
Dependencies/Couplings	Selecting MAXimum MINimum force to visible “Max Hold Trace” on page 340 or and “Min Hold Trace” on page 340 . Measure Trace stays in RMS or Video average state.
Preset	RMS
State Saved	Saved in instrument state.
Range	Pwr Avg (RMS) Log-Pwr Avg(Video) Maximum Minimum
Instrument S/W Revision	Prior to A.02.00

TD-SCDMA Mode

Key Path	Meas Setup
Mode	TD-SCDMA
Remote Command	[:SENSe] :TXPower :AVERage :TYPE LOG RMS [:SENSe] :TXPower :AVERage :TYPE ?
Example	TXP:AVER:TYPE LOG TXP:AVER:TYPE ?
Notes	You must be in the TD-SCDMA mode. Use INSTRument:SElect to set the mode.
Preset	RMS
State Saved	Saved in instrument state.
Range	Pwr Avg (RMS) Log-Pwr Avg(Video)
Instrument S/W Revision	Prior to A.02.00

Threshold Lvl

When Meas Method is set to Above Threshold Lvl, the mean carrier power is calculated based on the

Burst Power (Transmit Power) Meas Setup

trace above the threshold level. The threshold level is displayed in dB (relative to the measured carrier) or dBm (absolute).

A green line in the grid is displayed at the y-position associated with the current threshold level value. Its state is controlled by the On/Off state of the 'Display Line' under the View/Display menu.

Key Path	Meas Setup
Mode	SA, GSM, TD-SCDMA
Remote Command	<pre>[:SENSe]:TXPower:THReshold <real> [:SENSe]:TXPower:THReshold? [:SENSe]:TXPower:THReshold:TYPE ABSolute RELative [:SENSe]:TXPower:THReshold:TYPE?</pre>
Example	<pre>TXP:THR 0 TXP:THR?</pre>
Example	<pre>TXP:THR:TYPE ABS TXP:THR:TYPE?</pre>
Notes	<p>You must be in the TD-SCDMA mode, Spectrum Analyzer mode or GSM mode to use this command. Use INSTRUMENT:SElect to set the mode.</p> <p>BAF SCPI Command determines whether this command is setting an absolute or a relative power level.</p> <p>Suffix dB and dBm are allowed, but it does not change the state of Threshold Type.</p> <p>Suffix may not be send.</p> <p>If Threshold Type is set to Relative, the positive value of Threshold level was allowed to +100dB and it treated as a negative value. Now max value of Threshold level is changed to 0dB. To keep the backward compatibility, the input from SCPI command allows to +100dB.</p>
Preset	<pre>GSM: -20.0 SA: -30.0 TD-SCDMA : -60.0 RELative</pre>
State Saved	Saved in instrument state.
Min	-100
Max	<pre>GSM, SA: Relative : 0dB Absolute : 100dBm TD-SCDMA: Relative : 0dB Absolute : 60dBm</pre>
Instrument S/W Revision	Prior to A.02.00

Meas Method

There are two selections for this parameter; Above Threshold Level, and Measured Burst Width.

Above Threshold Level measurement algorithm is used to capture a time record, and average only those points in the time record that exceed the user-specified threshold level. No attempt is made to position the burst, or to calculate/display burst widths. This can be used to measure continuous signals, or bursted signals where the Measured Burst Width algorithm is too restrictive.

Measured Burst Width measurement algorithm uses the threshold level to calculate the burst center, and average those points that lie within a user-specified burst width that is centered upon the burst. The burst width parameter is described in more detail below.

If the mode is TD-SCDMA, there is a third selection.

Single Time Slot measurement algorithm is to capture a single time slot record, and calculate the start and stop position of the time slot in terms of the trigger position theoretically. No attempt is made to position the burst, or to calculate/display burst widths. The burst width drawn in the screen is considered to be the theoretical width of the slot. This method is recommended to measure the mean transmit power in a single slot when trigger source is External Front/Rear while the Measured Burst Width algorithm is too restrictive.

SA, GSM mode

Key Path	Meas Setup
Mode	SA, GSM
Remote Command	[:SENSe] :TXPower :METHod THReshold BWIDth [:SENSe] :TXPower :METHod?
Example	TXP:METH BWID TXP:METH?
Preset	THReshold
State Saved	Saved in instrument state.
Range	Above Threshold Lvl Measured Burst Width
Instrument S/W Revision	Prior to A.02.00

TD-SCDMA mode

Key Path	Meas Setup
Mode	TD-SCDMA
Remote Command	[:SENSe] :TXPower :METHod THReshold BWIDth SINGLE [:SENSe] :TXPower :METHod?
Example	TXP:METH BWID TXP:METH?

Burst Power (Transmit Power) Meas Setup

Preset	SINGLE
State Saved	Saved in instrument state.
Range	Threshold Lvl Measured Burst Width Single TimeSlot
Instrument S/W Revision	Prior to A.02.00

Burst Width

When Burst Width Mode is set to manual, the user may enter a fixed-time value in seconds, or alternatively specify the burst width as a percentage of the last measured burst width (result in bottom-left corner of second window).

Key Path	Meas Setup
Mode	SA, GSM, TD-SCDMA
Remote Command	[:SENSE] :TXPower :BURSt :WIDTh <time> [:SENSE] :TXPower :BURSt :WIDTh? [:SENSE] :TXPower :BURSt :AUTO ON OFF 1 0 [:SENSE] :TXPower :BURSt :AUTO?
Example	TXP:BURS:WIDT 10 TXP:BURS:WIDT? TXP:BURS:AUTO 1 TXP:BURS:AUTO?
Example	TXP:BURS:AUTO 0 TXP:BURS:AUTO? TXP:BURS:AUTO 1 TXP:BURS:AUTO?
Notes	You must be in the Spectrum Analyzer mode, TD-SCDMA mode or GSM mode to use this command. Use INSTRument:SElect to set the mode.

Dependencies/Couplings	<p>Burst Width will be grayed out if Meas Method is set to ‘Above Threshold Lvl’.</p> <p>SA, GSM</p> <p>Max value depends on Sweep Time, Res BW and RBW filter type.</p> <p>TD-SCDMA:</p> <p>If the measure method is not “Measured Burst Width”, this key will be grayed out.</p> <p>The default value is depending on the Burst type:</p> <p>If Burst Type = Traffic, Burst Width = 662.5us</p> <p>If Burst Type = Downlink Pilot, Burst Width = 50us</p> <p>If Burst Type = Uplink Pilot, Burst Width = 100us</p>
Preset	<p>SA, GSM: 255.6 us</p> <p>TD-SCDMA: 662.5us</p> <p>ON</p>
State Saved	Saved in instrument state.
Min	100.0 ns
Max	50 s
Instrument S/W Revision	Prior to A.02.00

IF Gain

The **IF Gain** key can be used to set the IF Gain function to Auto, or to On (the extra 10 dB) or Off. These settings affect sensitivity and IF overloads.

If the mode is TD-SCDMA, this function will NOT be available.

The front-panel key will display a blank menu key when pressed.

Key Path	Meas Setup
Mode	SA
Instrument S/W Revision	Prior to A.02.00

IF Gain Auto

Activates the auto rules for IF Gain.

Key Path	Meas Setup, More, IF Gain
Mode	SA, GSM
Remote Command	<p>[:SENSE] :TXPower : IF : GAIN : AUTO [: STATE] OFF ON 0 1</p> <p>[:SENSe] :TXPower : IF : GAIN : AUTO [: STATE] ?</p>

Burst Power (Transmit Power) Meas Setup

Example	TXP:IF:GAIN:AUTO ON TXP:IF:GAIN:AUTO?
Notes	You must be in the Spectrum Analyzer mode, GSM mode to use this command. Use INSTRUMENT:SElect to set the mode.
Dependencies/Couplings	IF Gain is not available when IQ Input is selected (the menu key is blank). When either the auto attenuation works (for example, with electrical attenuator), or the optimize mechanical attenuator range is requested, the IF Gain setting is changed according to the following rule. 'auto' sets IF Gain High under any of the following conditions: the input attenuator is set to 0 dB, the preamp is turned on, or the Max Mixer Level is 20 dBm or lower. For other settings, auto sets IF Gain to Low.
Preset	ON
State Saved	Saved in instrument state.
Range	Auto Man
Instrument S/W Revision	Prior to A.02.00

IF Gain State

Selects the range of the IF Gain.

Key Path	Meas Setup, More, IF Gain
Mode	SA, GSM
Remote Command	[:SENSe] :TXPower : IF : GAIN [:STATe] ON OFF 1 0 [:SENSe] :TXPower : IF : GAIN [:STATe] ?
Example	TXP:IF:GAIN ON TXP:IF:GAIN?
Notes	You must be in the Spectrum Analyzer mode, GSM mode to use this command. Use INSTRUMENT:SElect to set the mode. where ON = high gain OFF = low gain
Dependencies/Couplings	IF Gain is not available when IQ Input is selected (the menu key is blank) Sending this command forces "IF Gain Auto" on page 323 to OFF (Man).
Preset	OFF
State Saved	Saved in instrument state.
Range	Low Gain (Best for Large Signals) High Gain (Best Noise Level)
Instrument S/W Revision	Prior to A.02.00

Meas Interval (for TD-SCDMA mode)

Sets the number of slots to be captured for each measurement. Uplink and downlink pilots each count as one slot, so setting the Meas Interval parameter to 9 will display one full subframe.

Key Path	Meas Setup, More
Mode	TD-SCDMA
Remote Command	[:SENSe] :TXPower :SWEp:TIME <integer> [:SENSe] :TXPower :SWEp:TIME?
Example	TXP:SWE:TIME 4 TXP:SWE:TIME?
Notes	In Single Time Slot method, Meas Interval is set to 1 and the key is disabled automatically. You must be in the TDSCDMA mode to use this command. Use INSTRument:SElect to set the mode.
Dependencies/Couplings	When device in Radio menu changes: If device is BTS, Trigger Source: External Front, Method: Single Time Slot, Measure: Continuous, Measure Time: disabled (=1); If device is MS, Trigger Source: RF Burst, Method: Measured Burst Width, Measure: Single, Measure Time: enabled.
Preset	1
State Saved	Saved in instrument state.
Min	1
Max	18
Instrument S/W Revision	Prior to A.02.00

Meas Preset

Returns parameters for this measurement to those set by the factory.

Key Path	Meas Setup, More
----------	-------------------------

Burst Power (Transmit Power) Meas Setup

Mode	SA, GSM, TD-SCDMA
Remote Command	:CONFigure:TXPower
Example	CONF:TXP
Notes	You must be in the Spectrum Analyzer mode, TD-SCDMA mode or GSM mode to use this command. Use INSTRument:SElect to set the mode.
Instrument S/W Revision	Prior to A.02.00

Mode

Operation of this key is identical across several measurements. For details about this key, see [“Mode” on page 1145](#).

Mode Setup

Operation of this key is identical across several measurements. For details about this key, see “Frequency/Channel” on page 1061.

Peak Search

Places the selected marker on the trace point with the maximum y-axis value for that marker's trace. Pressing Peak Search with the selected marker off causes the selected marker to be set to Normal, then a peak search is immediately performed.

Key Path	Peak Search
Mode	GSM, SA, TD-SCDMA
Remote Command	:CALCulate:TXPower:MARKer[1] 2 3 4 5 6 7 8 9 10 11 12:MAXimum
Example	CALC:TXP:MARK2:MAX
Instrument S/W Revision	Prior to A.02.00

Recall

Operation of this key is identical across several measurements. For details about this key, see [“Recall” on page 1179](#).

Restart

Operation of this key is identical across several measurements. For details about this key, see [“Restart” on page 1201](#).

Burst Power (Transmit Power)
Save

Save

Operation of this key is identical across several measurements. For details about this key, see [“Save” on page 1203](#).

Single

Operation of this key is identical across several measurements. For details about this key, see [“Single \(Single Measurement/Sweep\)”](#) on page 1229.

Source

Operation of this key is identical across several measurements. For details about this key, see “[Source](#)” on page 1231.

SPAN X Scale

Accesses a menu of functions that enable you set the horizontal scale parameters.

Key Path	Front panel key
Instrument S/W Revision	Prior to A.02.00

Ref Value

Enables you to set the display X reference value.

Key Path	SPAN X Scale
Mode	SA, GSM, TD-SCDMA
Remote Command	:DISPlay:TXPower:VIEW[1]:WINDow[1]:TRACe:X[:SCALe]:RLEV e1 <time> :DISPlay:TXPower:VIEW[1]:WINDow[1]:TRACe:X[:SCALe]:RLEV e1?
Example	DISP:TXP:VIEW:WIND:TRAC:X:RLEV 1s DISP:TXP:VIEW:WIND:TRAC:X:RLEV?
Notes	You must be in the Spectrum Analyzer mode, TD-SCDMA mode or GSM mode to use this command. Use INSTRument:SElect to set the mode.
Dependencies/Couplings	If the “Auto Scaling” on page 337 is On, this value is automatically determined by the measurement result. When you set a value manually, “Auto Scaling” on page 337 automatically changes to Off.
Preset	0 s
State Saved	Saved in instrument state.
Min	-10.0 s
Max	10.00 s
Instrument S/W Revision	Prior to A.02.00

Scale/Div

Enables you to set the display X scale/division value.

Key Path	SPAN X Scale
Mode	SA, GSM, TD-SCDMA

Burst Power (Transmit Power) SPAN X Scale

Remote Command	:DISPlay:TXPower:VIEW[1]:WINDow[1]:TRACe:X[:SCALE]:PDIV ision <time> :DISPlay:TXPower:VIEW[1]:WINDow[1]:TRACe:X[:SCALE]:PDIV ision?
Example	DISP:TXP:VIEW:WIND:TRAC:X:PDIV 1ms DISP:TXP:VIEW:WIND:TRAC:X:PDIV?
Notes	You must be in the Spectrum Analyzer mode, TD-SCDMA mode or GSM mode to use this command. Use INSTRument:SElect to set the mode.
Dependencies/Couplings	If the “ Auto Scaling ” on page 337 is on, this value is automatically determined by the measurement result. When you set a value manually, “ Auto Scaling ” on page 337 automatically changes to Off.
Preset	64.0 us
State Saved	Saved in instrument state.
Min	1.00 ns
Max	1.00 s
Instrument S/W Revision	Prior to A.02.00

Ref Position

Enables you to set the display X reference position to Left, Center or Right.

Key Path	SPAN X Scale
Mode	SA, GSM, TD-SCDMA
Remote Command	:DISPlay:TXPower:VIEW[1]:WINDow[1]:TRACe:X[:SCALE]:RPOS ition LEFT CENTer RIGHT :DISPlay:TXPower:VIEW[1]:WINDow[1]:TRACe:X[:SCALE]:RPOS ition?
Example	DISP:TXP:VIEW:WIND:TRAC:X:RPOS LEFT DISP:TXP:VIEW:WIND:TRAC:X:RPOS?
Notes	You must be in the Spectrum Analyzer mode, TD-SCDMA mode or GSM mode to use this command. Use INSTRument:SElect to set the mode.
Preset	LEFT
State Saved	Saved in instrument state.
Range	Left Ctr Right
Instrument S/W Revision	Prior to A.02.00

Auto Scaling

Enables you to toggle the X auto scaling function between On and Off.

Key Path	SPAN X Scale
Mode	SA, GSM, TD-SCDMA
Remote Command	:DISPlay:TXPower:VIEW[1]:WINDow[1]:TRACe:X[:SCALe]:COUPl le 0 1 OFF ON :DISPlay:TXPower:VIEW[1]:WINDow[1]:TRACe:X[:SCALe]:COUPl le?
Example	DISP:TXP:VIEW:WIND:TRAC:X:COUP OFF DISP:TXP:VIEW:WIND:TRAC:X:COUP?
Notes	You must be in the Spectrum Analyzer mode, TD-SCDMA mode or GSM mode to use this command. Use INSTRument:SELEct to set the mode.
Dependencies/Couplings	Upon pressing the Restart front-panel key, the scale coupling function automatically determines the scale per division and reference values based on the measurement results if this parameter is set to On. When you set a value to either X Rel Value or X Scale/Div manually, X Auto Scaling automatically changes to Off.
Preset	ON
State Saved	Saved in instrument state.
Range	On Off
Instrument S/W Revision	Prior to A.02.00

Sweep/Control

Accesses a menu of functions that enable you to set up and control the sweep for the current measurement. For details about this key, see “Sweep / Control” on page 1235.

Key Path	Front panel key
Mode	SA, GSM, TD-SCDMA
Instrument S/W Revision	Prior to A.02.00

Sweep Time (for SAmode)

Sets the sweep time to capture and show on screen.

Key Path	Sweep/Control
Mode	SA
Remote Command	[:SENSe] :TXPower :SWEep :TIME <time> [:SENSe] :TXPower :SWEep :TIME?
Example	TXP:SWE:TIME 10 TXP:SWE:TIME?
Notes	You must be in the Spectrum Analyzer mode to use this command. Use INSTRument:SElect to set the mode.
Preset	640 us
State Saved	Saved in instrument state.
Min	1.0e-6
Max	50
Instrument S/W Revision	Prior to A.02.00

Sweep Time (for GSM mode)

Sets the number of slots which are used in each data acquisition. Each slot is approximately to 600 s.

Key Path	Sweep/Control
Mode	GSM
Remote Command	[:SENSe] :TXPower :SWEep :TIME <integer> [:SENSe] :TXPower :SWEep :TIME?
Example	TXP:SWE:TIME 4 TXP:SWE:TIME?

Notes	You must be in the GSM mode to use this command. Use INSTRument:SElect to set the mode.
Preset	1
State Saved	Saved in instrument state.
Min	1
Max	50
Instrument S/W Revision	Prior to A.02.00

Pause/Resume

Pauses a measurement after the current data acquisition is complete.

When Paused, the label on the key changes to Resume. Pressing Resume un-pauses the measurement.

Since this functionality is mode global, see Mode functionality section or other section for details.

Key Path	Sweep/Control
Mode	SA, GSM, TD-SCDMA
Instrument S/W Revision	Prior to A.02.00

Trace/Detector

Accesses a menu of functions that enable you to control the detectors for the current measurement.

Key Path	Front panel key
Instrument S/W Revision	Prior to A.02.00

Max Hold Trace

This key enables you to select visible/invisible Max Hold Trace.

Key Path	Trace/Detector
Mode	SA, GSM, TD-SCDMA
Remote Command	:DISPlay:TXPower:VIEW[1]:WINDow[1]:TRACe:MAXHold[:STATe]] ON OFF 1 0 :DISPlay:TXPower:VIEW[1]:WINDow[1]:TRACe:MAXHold[:STATe]]?
Example	:DISP:TXP:VIEW:WIND:TRAC:MAXH ON :DISP:TXP:VIEW:WIND:TRAC:MAXH?
Notes	You must be in the Spectrum Analyzer mode, TD-SCDMA mode or GSM mode to use this command. Use INSTRUMENT:SElect to set the mode.
Dependencies/Couplings	Selecting [:SENSe]:TXPower:AVERage:TYPE MAXimum forces this parameter to ON.
Preset	OFF
State Saved	Saved in instrument state.
Range	On Off
Instrument S/W Revision	Prior to A.02.00

Min Hold Trace

This key enables you to select visible/invisible Min Hold Trace.

Key Path	Trace/Detector
Mode	SA, GSM, TD-SCDMA
Remote Command	:DISPlay:TXPower:VIEW[1]:WINDow[1]:TRACe:MINHold[:STATe]] ON OFF 1 0 :DISPlay:TXPower:VIEW[1]:WINDow[1]:TRACe:MINHold[:STATe]]?

Example	:DISP:TXP:VIEW:WIND:TRAC:MINH ON :DISP:TXP:VIEW:WIND:TRAC:MINH?
Notes	You must be in the Spectrum Analyzer mode, TD-SCDMA mode or GSM mode to use this command. Use INSTRUMENT:SELEct to set the mode.
Dependencies/Couplings	Selecting [:SENSe]:TXPower:AVERAge:TYPE MINimum forces this parameter to ON.
Preset	OFF
State Saved	Saved in instrument state.
Range	On Off
Instrument S/W Revision	Prior to A.02.00

Trigger

Operation of this key is identical across several measurements. For details about this key, see [“Trigger”](#) on page 1253.

View/Display

The View/Display key opens up the View menu for the current measurement. The views that are available are specific to the current measurement selected under the **Meas** key. Many of the lower-level menu keys are also the same across all measurements. Unique functions are described below.

This measurement consists of one view, which consists of two windows.

“RF Envelope view for TX Power Measurement(Above Threshold)” on page 343

“RF Envelope view with Bar Graph for TX Power Measurement (Measured Burst Width)” on page 344

“RF Envelope view with Bar Graph for TX Power Measurement (Single TimeSlot)” on page 345

RF Envelope view for TX Power Measurement(Above Threshold)

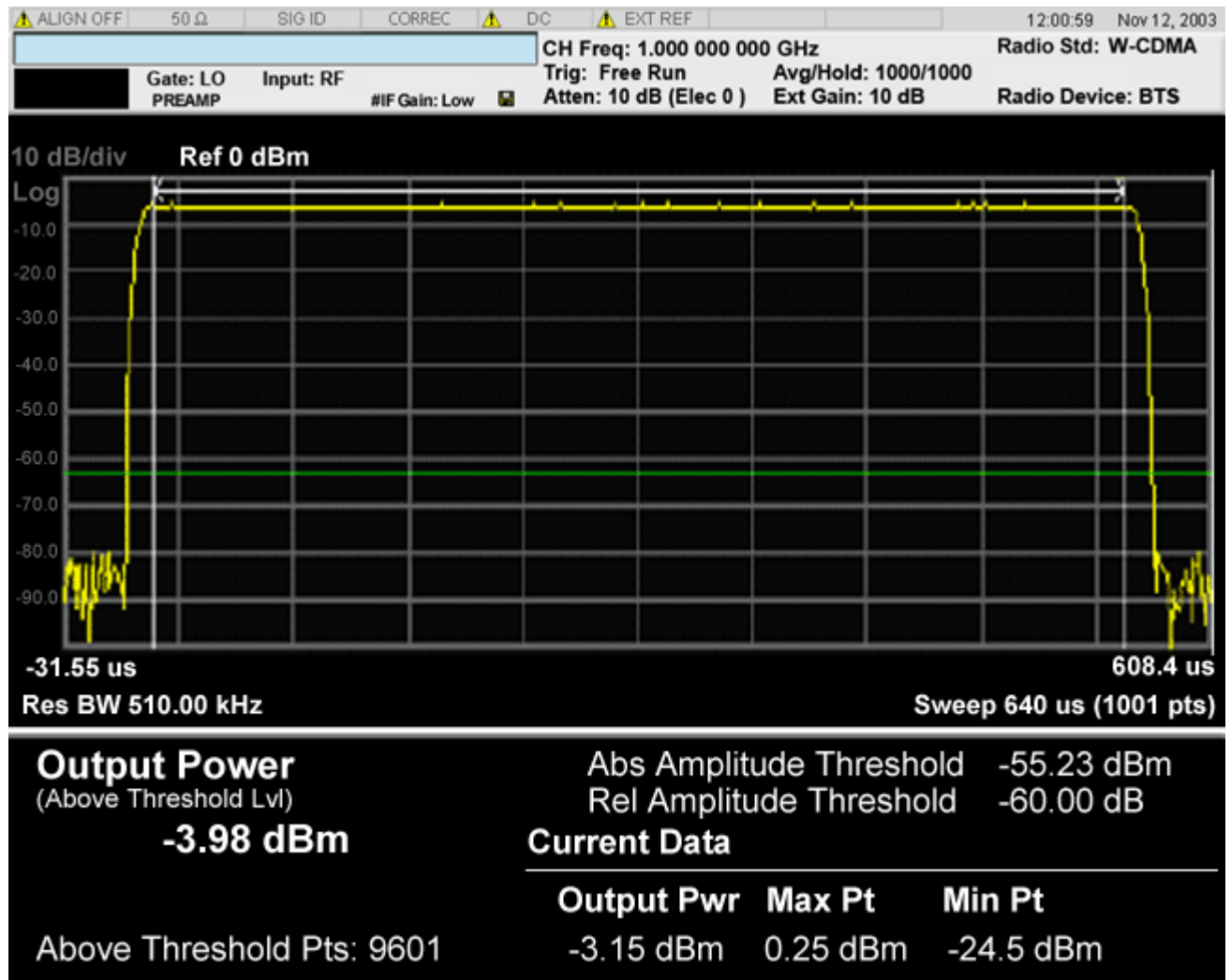

Burst Power (Transmit Power)
View/Display

RF Envelope view with Bar Graph for TX Power Measurement (Measured Burst Width)

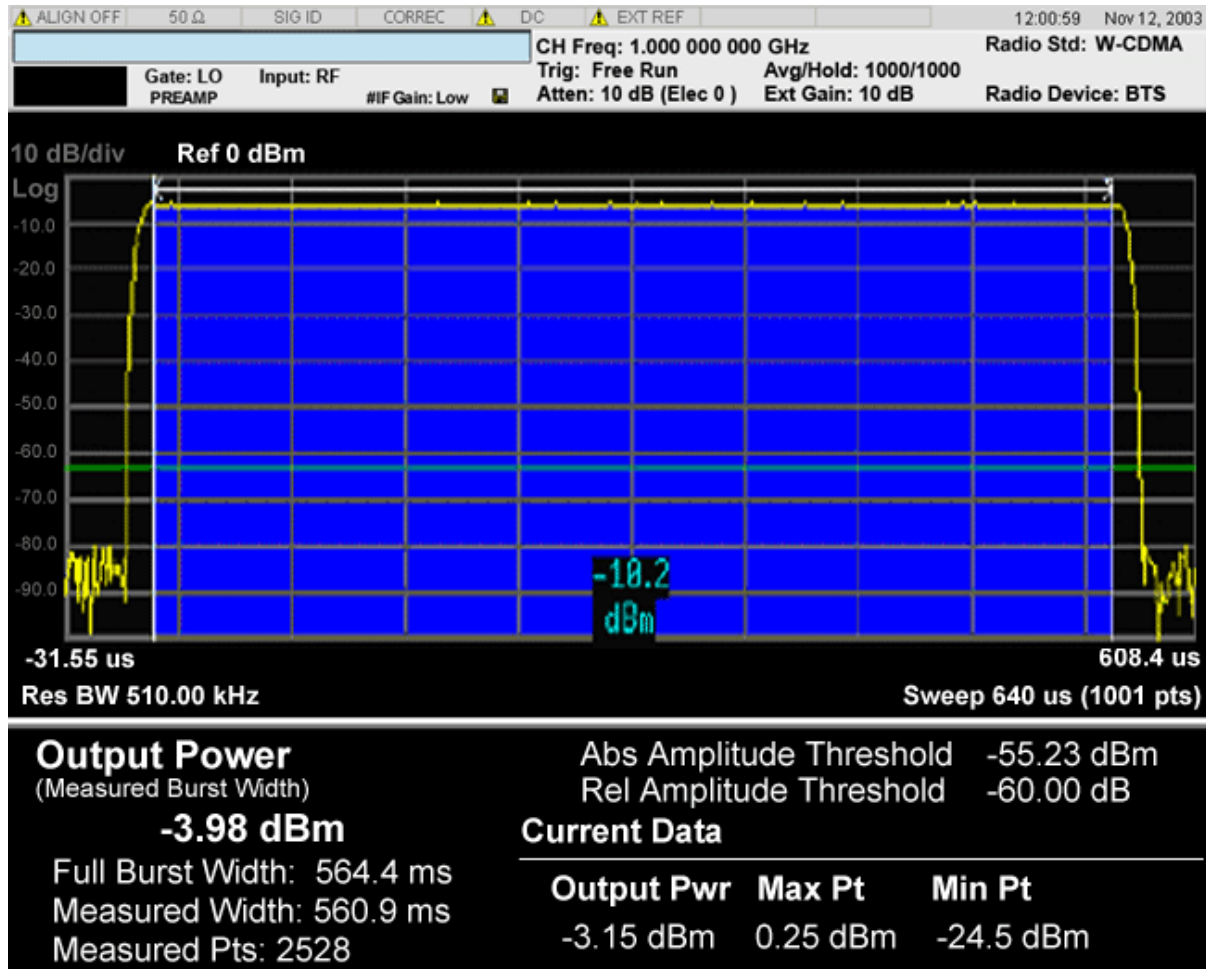

Burst Power (Transmit Power)
View/Display

Mean Transmit Power	n=1 3rd	99.99 dBm
Above Threshold or Measured Burst Width	Power Value above the threshold or measured burst width for N averages, if averaging is on. An average consists of N acquisitions of data which represents the current trace. If averaging is off, the value of power averaged is the same as the Mean Transmit Power of Current Data.	
Full Burst Width	n=1 9th	999.9 us
	Burst width that is determined by the “Threshold Lvl” on page 319 .	
Measured Width	n=1 10th	999.9 us
	Time length that is used to calculate Mean Transmit Power when “Meas Method” on page 321 is Measured Burst Width. If “Meas Method” on page 321 is set to Above Threshold, disappear from the window.	
Above Thresh Pts	n=1 6th	9999
	Number of points that were above the threshold level and were used for the power calculation when “Meas Method” on page 321 is Above Threshold Level.	
Thresh Pts	N=1 6th	9999
	Number of points that were used for the power calculation when Meas Method is Measured Burst Width.	
Abs Amplitude Threshold	n=1 5th	99.99 dBm
	Threshold value is the threshold (in dBm) above which the power is calculated.	
Rel Amplitude Threshold		99.99 dB
	Threshold (in dB) relative to the peak carrier level above which the power is calculated	
Mean Transmit power (Current data)	n=1 2nd	99.99 dBm
	Power value above the threshold or measured burst width. If averaging is on, the power is for the latest acquisition.	
Max Pt	n=1 7th	99.99 dBm
	Maximum peak level of the most recently acquired trace data.	
Min Pt	n=1 8th	99.99 dBm
	Minimum peak level of the most recently acquired trace data.	
Key Path	Front panel key	
Mode	SA, GSM, TD-SCDMA	
Instrument S/W Revision	Prior to A.02.00	

Display

Invokes Display menu. All measurements have same Display menu and same functionality for each key under Display menu. For details about this key, see “Display” on page 1307.

Key Path	View/Display
Mode	SA, GSM, TD-SCDMA
Instrument S/W Revision	Prior to A.02.00

Bar Graph

Enables you to select visible/invisible Bar Graph.

Key Path	View/Display
Mode	SA, GSM, TD-SCDMA
Remote Command	:DISPlay:TXPower:BARGraph[:STATe] ON OFF 1 0 :DISPlay:TXPower:BARGraph[:STATe]?
Example	DISP:TXP:BARG ON DISP:TXP:BARG?
Preset	OFF
State Saved	Saved in instrument state.
Range	On Off
Instrument S/W Revision	Prior to A.02.00

Burst Power (Transmit Power)
View/Display

ACP is a measurement of the amount of interference, or power, in an adjacent frequency channel. The results are displayed as a bar graph or as spectrum data, with measurement data at specified offsets. For measurement results and views, see [“View/Display” on page 430](#).

This topic contains the following sections:

[“Measurement Commands for ACP” on page 349](#)

[“Remote Command Results for ACP Measurement” on page 349](#)

Measurement Commands for ACP

The following commands are used to retrieve the measurement results:

:CONFigure:ACP

:CONFigure:ACP:NDEFault

:INITiate:ACP

:FETCh:ACP[n]?

:READ:ACP[n]?

:MEASure:ACP[n]?

For more measurement related commands, see the SENSE subsystem, and the section [“Remote Measurement Functions” on page 1127](#).

Remote Command Results for ACP Measurement

Condition	N	Results Returned
Mode = SA mode, Radio Std = None, Number of carriers = 1 and only offset A is on	Not specified or n=1	Returns 3 comma-separated values that correspond to: Reference carrier power, lower-adjacent channel power (dBc), and upper-adjacent channel power (dBc).

ACP Measurement

Meas Type = Total power reference	Not specified or n=1	Returns 28 comma-separated scalar results, in the following order. <ol style="list-style-type: none">1. 0.02. Total carrier power (dBm)3. 0.04. Reference carrier power (dBm)5. Lower offset A - relative power (dB)6. Lower offset A - absolute power (dBm)7. Upper offset A - relative power (dB)8. Upper offset A - absolute power (dBm)9. Lower offset B - relative power (dB)10. Lower offset B - absolute power (dBm)11. Upper offset B - relative power (dB)12. Upper offset B - absolute power (dBm)...25. Lower offset F - relative power (dB)26. Lower offset F - absolute power (dBm)27. Upper offset F - relative power (dB)28. Upper offset F - absolute power (dBm) If the results are not available, -999.0 is returned.
---	-------------------------	--

Meas Type = Power spectral density reference	not specified or n=1	<p>Returns 28 comma-separated scalar results, in the following order.</p> <ol style="list-style-type: none"> 1. 0.0 2. Total carrier power (dBm/Hz or dBm/MHz) 3. 0.0 4. Reference carrier power (dBm/Hz or dBm/MHz) 5. Lower offset A - relative power (dB) 6. Lower offset A - absolute power (dBm/Hz or dBm/MHz) 7. Upper offset A - relative power (dB) 8. Upper offset A - absolute power (dBm/Hz or dBm/MHz) 9. Lower offset B - relative power (dB) 10. Lower offset B - absolute power (dBm/Hz or dBm/MHz) 11. Upper offset B - relative power (dB) 12. Upper offset B - absolute power (dBm/Hz or dBm/MHz) ... 25. Lower offset F - relative power (dB) 26. Lower offset F - absolute power (dBm/Hz or dBm/MHz) 27. Upper offset F - relative power (dB) 28. Upper offset F - absolute power (dBm/Hz or dBm/MHz) <p>If the results are not available, -999.0 is returned.</p>
Meas Method = FAST	not specified or n=1	<p>Returns 5 comma-separated results, in the following order:</p> <ol style="list-style-type: none"> 1. Reference carrier - absolute power (dBm) 2. Lower offset A - absolute power (dBm) 3. Upper offset A - absolute power (dBm) 4. Lower offset B - absolute power (dBm) 5. Upper offset B - absolute power (dBm)

Meas Type = 2
Total power
reference

Returns 48 scalar results, in the following order:

1. Channel (1) - relative power (dB)
2. Channel (1) - absolute power (dBm)
3. Channel (2) - relative power (dB)
4. Channel (2) - absolute power (dBm)
- ...
23. Channel (12) - relative power (dB)
24. Channel (12) - absolute power (dBm)
25. Lower offset A - relative power (dB)
26. Lower offset A - absolute power (dBm)
27. Upper offset A - relative power (dB)
28. Upper offset A - absolute power (dBm)
29. Lower offset B - relative power (dB)
30. Lower offset B - absolute power (dBm)
31. Upper offset B - relative power (dB)
32. Upper offset B - absolute power (dBm)
- ...
45. Lower offset F - relative power (dB)
46. Lower offset F - absolute power (dBm)
47. Upper offset F - relative power (dB)
48. Upper offset F - absolute power (dBm)

If the results are not available, -999.0 is returned.

Meas Type = 2
 Power spectral
 density
 reference

Returns 48 scalar results, in the following order:

1. Channel (1) - relative power (dB)
2. Channel (1) - absolute power (dBm/Hz or dBm/MHz)
3. Channel (2) - relative power (dB)
4. Channel (2) - absolute power (dBm/Hz or dBm/MHz)
- ...
23. Channel (12) - relative power (dB)
24. Channel (12) - absolute power (dBm/Hz or dBm/MHz)
25. Lower offset A - relative power (dB)
26. Lower offset A - absolute power (dBm/Hz or dBm/MHz)
27. Upper offset A - relative power (dB)
28. Upper offset A - absolute power (dBm/Hz or dBm/MHz)
29. Lower offset B - relative power (dB)
30. Lower offset B - absolute power (dBm/Hz or dBm/MHz)
31. Upper offset B - relative power (dB)
32. Upper offset B - absolute power (dBm/Hz or dBm/MHz)
- ...
45. Lower offset F - relative power (dB)
46. Lower offset F - absolute power (dBm/Hz or dBm/MHz)
47. Upper offset F - relative power (dB)
48. Upper offset F - absolute power (dBm/Hz or dBm/MHz)

If the results are not available, -999.0 is returned.

ACP Measurement

Meas Type = Total power reference	3	Returns 24 scalar values of the pass/fail (0 = passed, or 1 = failed) determined by testing the relative to the reference carrier and by testing the absolute power limit of the offset frequencies (measured as total power in dB): 1. Lower offset A - relative limit result 2. Lower offset A - absolute limit result 3. Upper offset A - relative limit result 4. Upper offset A - absolute limit result 5. Lower offset B - relative limit result 6. Lower offset B - absolute limit result 7. Upper offset B - relative limit result 8. Upper offset B - absolute limit result ... 21 Lower offset F - relative limit result 22 Lower offset F - absolute limit result 23 Upper offset F - relative limit result 24 Upper offset F - absolute limit result
Meas Type = Power spectral density reference	3	Returns 24 scalar values of the pass/fail (0 = passed, or 1 = failed) determined by testing the relative to the reference carrier and by testing the absolute power limit of the offset frequencies (measured as power spectral density in dB): 1. Lower offset A - relative limit result 2. Lower offset A - absolute limit result 3. Upper offset A - relative limit result 4. Upper offset A - absolute limit result 5. Lower offset B - relative limit result 6. Lower offset B - absolute limit result 7. Upper offset B - relative limit result 8. Upper offset B - absolute limit result ... 21 Lower offset F - relative limit result 22 Lower offset F - absolute limit result 23 Upper offset F - relative limit result 24 Upper offset F - absolute limit result
	4	Returns <Num Pts> comma-separated scalar values representing the Y values in Trace 1

- 5 Returns <Num Pts> comma-separated scalar values representing the Y values in Trace 2
- 6 Returns <Num Pts> comma-separated scalar values representing the Y values in Trace 3

Key Path

Front-panel key

Instrument S/W Revision

Prior to A.02.00

AMPTD Y Scale

Accesses a menu of functions that enable you to set the vertical scale parameters. The parameter values are measurement independent, except all Attenuation values and the Internal Preamp selections, which are the same across all measurements.

Key Path	Front-panel key
Instrument S/W Revision	Prior to A.02.00

Ref Value

Sets the value for the absolute power reference. However, since the Auto Scaling is defaulted to On, this value is automatically determined by the measurement result. When you set a value manually, Auto Scaling automatically changes to Off.

Remote Command	<code>:DISPlay:ACPower:VIEW[1]:WINDow[1]:TRACe:Y[:SCALE]:RLEV e1 <real></code> <code>:DISPlay:ACPower:VIEW[1]:WINDow[1]:TRACe:Y[:SCALE]:RLEV e1?</code>
Example	<code>DISP:ACP:VIEW:WIND:TRAC:Y:RLEV 100</code> <code>DISP:ACP:VIEW:WIND:TRAC:Y:RLEV?</code>
Dependencies/Couplings	When the Auto Scaling is On, this value is automatically determined by the measurement result. When you set a value manually, Auto Scaling automatically changes to Off.
Key Path	AMPTD Y Scale
Mode	SA, WCDMA, C2K, WIMAX OFDMA, TD-SCDMA, 1xEVDO, DVB-T/H, DTMB
Notes	You must be in the mode that includes ACP measurements to use this command. Use <code>:INSTrument:SElect</code> to set the mode.
Preset	All Except CDMA1xEVDO: 10.00 dBm CDMA1xEVDO: -10dBm
State Saved	Saved in instrument state.
Min	-250.00 dBm
Max	250.00 dBm
Instrument S/W Revision	Prior to A.02.00

Attenuation

Accesses a menu of functions that enable you to change attenuation settings. This key has read-back text

that describes the total attenuator value.

See AMPTD Y Scale, “[Attenuation](#)” on page 1037 in the “Common Measurement Functions” section for more information.

Key Path	AMPTD Y Scale
Instrument S/W Revision	Prior to A.02.00

Scale/Div

Sets the units-per-division of the vertical scale in the logarithmic display. However, since the Auto Scaling is defaulted to On, this value is automatically determined by the measurement result. When you set a value manually, Auto Scaling automatically changes to Off.

Remote Command	<code>:DISPlay:ACPower:VIEW[1]:WINDow[1]:TRACe:Y[:SCALe]:PDIVision <rel_ampl></code> <code>:DISPlay:ACPower:VIEW[1]:WINDow[1]:TRACe:Y[:SCALe]:PDIVision?</code>
Example	<code>DISP:ACP:VIEW:WIND:TRAC:Y:PDIV 5</code> <code>DISP:ACP:VIEW:WIND:TRAC:Y:PDIV?</code>
Dependencies/Couplings	When the Auto Scaling is On, this value is automatically determined by the measurement result. When you set a value manually, Auto Scaling automatically changes to Off.
Key Path	AMPTD Y Scale
Mode	SA, WCDMA, C2K, WIMAX OFDMA, TD-SCDMA, 1xEVDO, DVB-T/H, DTMB
Notes	You must be in the mode that includes ACP measurements to use this command. Use <code>:INSTrument:SElect</code> to set the mode.
Preset	10.00 dB
State Saved	Saved in instrument state.
Min	0.10 dB
Max	20.00 dB
Instrument S/W Revision	Prior to A.02.00

Presel Center

See AMPTD Y Scale, “[Presel Center](#)” on page 1049 in the “Common Measurement Functions” section for more information.

Presel Adjust

See AMPTD Y Scale, “[Preselector Adjust](#)” on page 1050 in the “Common Measurement Functions”

section for more information.

Internal Preamp

Accesses a menu of functions that enable you to control the internal preamplifiers.

See AMPTD Y Scale, “[Internal Preamp](#)” on page 1052 in the “Common Measurement Functions” section for more information.

Key Path	AMPTD Y Scale
Instrument S/W Revision	Prior to A.02.00

Ref Position

Positions the reference level at the top, center, or bottom of the Y- scale display. Changing the reference position does not change the reference level value.

Remote Command	<code>:DISPlay:ACPower:VIEW[1]:WINDow[1]:TRACe:Y[:SCALE]:RPOSITION TOP CENTer BOTTom</code> <code>:DISPlay:ACPower:VIEW[1]:WINDow[1]:TRACe:Y[:SCALE]:RPOSITION?</code>
Example	<code>DISP:ACP:VIEW:WIND:TRAC:Y:RPOS CENT</code> <code>DISP:ACP:VIEW:WIND:TRAC:Y:RPOS?</code>
Key Path	AMPTD Y Scale
Mode	SA, WCDMA, C2K, WIMAX OFDMA, TD-SCDMA, 1xEVDO, DVB-T/H, DTMB
Notes	You must be in the mode that includes ACP measurements to use this command. Use <code>:INSTrument:SElect</code> to set the mode.
Preset	TOP
State Saved	Saved in instrument state.
Range	Top Ctr Bot
Instrument S/W Revision	Prior to A.02.00

Auto Scaling

Toggles the Auto Scaling function between On and Off.

Remote Command	<code>:DISPlay:ACPower:VIEW[1]:WINDow[1]:TRACe:Y[:SCALE]:COUPle 0 1 OFF ON</code> <code>:DISPlay:ACPower:VIEW[1]:WINDow[1]:TRACe:Y[:SCALE]:COUPle?</code>
-----------------------	--

Example	DISP:ACP:VIEW:WIND:TRAC:Y:COUP ON DISP:ACP:VIEW:WIND:TRAC:Y:COUP?
Dependencies/Couplings	When Auto Scaling is On and the Restart front-panel key is pressed, this function automatically determines the scale per division and reference values based on the measurement results. When you set a value to either Scale/Div or Ref Value manually, Auto Scaling automatically changes to Off.
Key Path	AMPTD Y Scale
Mode	SA, WCDMA, C2K, WIMAX OFDMA, TD-SCDMA, 1xEVDO, DVB-T/H, DTMB
Notes	You must be in the mode that includes ACP measurements to use this command. Use :INSTrument:SELEct to set the mode.
Preset	ON
State Saved	Saved in instrument state.
Range	On Off
Instrument S/W Revision	Prior to A.02.00

Auto Couple

See “[AUTO COUPLE](#)” on page 1055 in the section "Common Measurement Functions" for more information.

BW

Accesses a menu of functions that enable you to specify and control the video and resolution bandwidths. You can also select the type of filter for the measurement and set the filter bandwidth.

Key Path	Front-panel key
Instrument S/W Revision	Prior to A.02.00

Res BW

Sets the value of the resolution bandwidth. If an unavailable bandwidth is entered with the numeric keypad, the closest available bandwidth is selected.

Remote Command	<pre>[:SENSe]:ACPower:BANDwidth[:RESolution] <bandwidth> [:SENSe]:ACPower:BANDwidth[:RESolution]? [:SENSe]:ACPower:BANDwidth[:RESolution]:AUTO ON OFF 1 0 [:SENSe]:ACPower:BANDwidth[:RESolution]:AUTO?</pre>
Example	<pre>ACP:BAND 25kHz ACP:BAND? ACP:BAND:AUTO ON ACP:BAND:AUTO?</pre>
Dependencies/Couplings	The resolution bandwidth is coupled to the video bandwidth based on the video to resolution bandwidth ratio setting if AUTO is selected.
Key Path	BW
Mode	SA, WCDMA, C2K, WIMAX OFDMA, TD-SCDMA, 1xEVDO, DVB-T/H, DTMB
Notes	<p>This key is available only in IBW mode.</p> <p>This parameter is preset by the Meas Method selection. Preset values are as follows:</p> <pre>IBW: 100 kHz IBWR: 27 kHz FAST (WCDMA): 390 kHz</pre> <p>You must be in the mode that includes ACP measurements to use this command. Use :INSTrument:SElect to set the mode.</p>

ACP Measurement BW

Preset	SA: 220 kHz WCDMA: 100 kHz WIMAX OFDMA: 100 kHz C2K: Method RBW: grayed out(1.2MHz) Method IBW: 15kHz TD-SCDMA: 30 kHz 1xEVDO: 30 kHz DVB-T/H: 39kHz DTMB: 39kHz 0
State Saved	Saved in instrument state.
Min	1 Hz
Max	8 MHz
Instrument S/W Revision	Prior to A.02.00

Video BW

Changes the analyzer post-detection filter (VBW).

Remote Command	<code>[:SENSe] :ACPower :BANDwidth :VIDeo <freq></code> <code>[:SENSe] :ACPower :BANDwidth :VIDeo?</code> <code>[:SENSe] :ACPower :BANDwidth :VIDeo :AUTO OFF ON 0 1</code> <code>[:SENSe] :ACPower :BANDwidth :VIDeo :AUTO?</code>
Example	ACP:BAND:VID 1kHz ACP:BAND:VID? ACP:BWID:VID:AUTO ON ACP:BWID:VID:AUTO?
Key Path	BW
Mode	SA, WCDMA, C2K, WIMAX OFDMA, TD-SCDMA, 1xEVDO, DVB-T/H, DTMB
Notes	The values shown in this table reflect the conditions after a Mode Preset.

Preset	SA: 22 kHz WCDMA, WIMAX OFDMA: 1MHz C2K: Method RBW: grayed out(1.2MHz) Method IBW: 150 kHz TD-SCDMA: 300 kHz 1xEVDO: 300kHz DVB-T/H: 390kHz DTMB: 390kHz SA: ON WCDMA:OFF WIMAX OFDMA: OFF TD-SCDMA: OFF DVB-T/H: ON DTMB: ON CDMA1xEVDO: OFF
State Saved	Saved in instrument state.
Min	1 Hz
Max	50 MHz
Instrument S/W Revision	Prior to A.02.00

RBW Control

Accesses a menu that enables you to select the filter bandwidth and type.

Key Path	BW
Instrument S/W Revision	Prior to A.02.00

Filter Type

Selects the type of bandwidth filter that is used. The choices are Gaussian or Flat top.

Remote Command	[:SENSe]:ACPower:BANDwidth:SHAPE GAUSSian FLATtop [:SENSe]:ACPower:BANDwidth:SHAPE?
Example	ACP:BAND:SHAP GAUS ACP:BAND:SHAP?
Key Path	BW, RBW Control

ACP Measurement BW

Mode	SA, WCDMA, C2K, WIMAX OFDMA, TD-SCDMA, 1xEVDO, DVB-T/H, DTMB
Preset	GAUSSian
State Saved	Saved in instrument state.
Range	Gaussian (Normal) Flattop
Instrument S/W Revision	Prior to A.02.00

Filter BW

Selects a Gaussian filter based on its -3 dB (Normal) bandwidth or its -6 dB bandwidth.

Remote Command	[:SENSe] :ACPower :BANDwidth :TYPE DB3 DB6 [:SENSe] :ACPower :BANDwidth :TYPE?
Example	ACP:BAND:TYPE DB3 ACP:BAND:TYPE?
Dependencies/Couplings	Grayed out when Meas Method is RBW.
Key Path	BW, RBW Control
Mode	SA, WCDMA, C2K, WIMAX OFDMA, TD-SCDMA, 1xEVDO, DVB-T/H, DTMB
Preset	DB3
State Saved	Saved in instrument state.
Range	-3 dB (Normal) -6 dB
Instrument S/W Revision	Prior to A.02.00

Cont

See “[Cont \(Continuous Measurement/Sweep\)](#)” on page 1059 in the section "Common Measurement Functions" for more information.

FREQ Channel

See “[Frequency/Channel](#)” on page 1061 in the section “Common Measurement Functions” for more information.

Input/Output

See “[Input/Output](#)” on page 1065 in the section “Common Measurement Functions” for more information.

Marker

Accesses a menu that enables you to select, set up and control the markers for the current measurement.

Key Path	Front-panel key
Instrument S/W Revision	Prior to A.02.00

Select Marker

Displays 12 markers available for selection.

Key Path	Marker
Instrument S/W Revision	Prior to A.02.00

Marker Type

Sets the marker control mode to **Normal**, **Delta**, **Fixed** or **Off**. All interactions and dependencies detailed under the key description are enforced when the remote command is sent. If the selected marker is **Off**, pressing **Marker** sets it to **Normal** and places it at the center of the screen on the trace determined by the **Marker Trace** rules. At the same time, **Marker X Axis Value** appears on the Active Function area.

The default active function is the active function for the currently selected marker control mode. If the current control mode is **Off**, there is no active function and the active function is turned off.

Remote Command	:CALCulate:ACPower:MARKer[1] 2 3 4 5 6 7 8 9 10 11 12:MODE POSITION DELTA OFF :CALCulate:ACPower:MARKer[1] 2 3 4 5 6 7 8 9 10 11 12:MODE?
Example	CALC:ACP:MARK2:MODE DELT CALC:ACP:MARK2:MODE?
Key Path	Marker
Mode	SA, WCDMA, C2K, WIMAX OFDMA, TD-SCDMA, 1xEVDO, DVB-T/H, DTMB

Notes	<p>If the selected marker is Off, pressing Marker sets it to Normal and places it at the center of the screen on the trace determined by the Marker Trace rules. At the same time, Marker X Axis Value appears on the Active Function area.</p> <p>Default Active Function: the active function for the selected marker's current control mode. If the current control mode is Off, there is no active function and the active function is turned off.</p> <p>Active Function Display: the marker X axis value entered in the active function area will display the marker value to its full entered precision.</p> <p>You must be in the mode that includes ACP measurements to use this command. Use :INSTrument:SElect to set the mode.</p>
Preset	OFF OFF OFF OFF OFF OFF OFF OFF OFF OFF OFF OFF
State Saved	Saved in instrument state.
Range	Normal Delta Off
Instrument S/W Revision	Prior to A.02.00

Marker X Axis Value (Remote Command only)

Sets the marker X axis value in the current marker X Axis Scale unit. This value has no effect if the control mode is **Off**, but is the SCPI equivalent of entering an X value if the control mode is **Normal**, **Delta** or **Fixed**.

Remote Command	<pre>:CALCulate:ACPower:MARKer[1] 2 3 4 5 6 7 8 9 10 11 12:X <freq> :CALCulate:ACPower:MARKer[1] 2 3 4 5 6 7 8 9 10 11 12:X ?</pre>
Example	<pre>CALC:ACP:MARK3:X 0 CALC:ACP:MARK3:X?</pre>
MIN/MAX/DEF Support	Yes
Mode	SA, WCDMA, C2K, WIMAX OFDMA, TD-SCDMA, 1xEVDO, DVB-T/H, DTMB
Notes	The query returns the marker's absolute X Axis value if the control mode is Normal , or the offset from the marker's reference marker if the control mode is Delta . If the marker is Off the response is not a number.
Preset	After a preset, all Markers are turned OFF, so Marker X Axis Value query will return a not a number (NAN).
State Saved	No
Min	-9.9E+37
Max	9.9E+37

Instrument S/W Revision Prior to A.02.00

Marker X Axis Position (Remote Command only)

Sets the marker X position in trace points. It has no effect if the control mode is **Off**, but is the SCPI equivalent of entering a value if the control mode is **Normal**, **Delta** or **Fixed**. The entered value is immediately translated into the current X Axis Scale units for setting the value of the marker.

Remote Command	:CALCulate:ACPower:MARKer[1] 2 3 4 5 6 7 8 9 10 11 12:X :POSition <real> :CALCulate:ACPower:MARKer[1] 2 3 4 5 6 7 8 9 10 11 12:X :POSition?
Example	CALC:ACP:MARK10:X:POS 0 CALC:ACP:MARK10:X:POS?
MIN/MAX/DEF Support	Yes
Mode	SA, WCDMA, C2K, WIMAX OFDMA, TD-SCDMA, 1xEVDO, DVB-T/H, DTMB
Notes	The query returns the marker's absolute X Axis value in trace points if the control mode is Normal , or the offset from the marker's reference marker in trace points if the control mode is Delta . The value is returned as a real number, not an integer, corresponding to the translation from X Axis Scale units to trace points (see "Fractional Trace Points"). If the marker is Off the response is not a number. When a Marker is turned on, it is placed center of the screen on the trace. Therefore the default value depends on instrument condition, although the Preset/Default is defined as 500 (this value might be expected value when all offset is on).
Preset	After a preset, all Markers are turned OFF, so Marker X Axis Value query will return a not a number (NAN).
State Saved	No
Min	-9.9E+37
Max	9.9E+37
Instrument S/W Revision	Prior to A.02.00

Marker Y Axis Value (Remote Command only)

Returns the marker Y axis value in the current marker Y axis unit.

Remote Command	:CALCulate:ACPower:MARKer[1] 2 3 4 5 6 7 8 9 10 11 12:Y ?
Example	CALC:ACP:MARK11:Y?

Mode	SA, WCDMA, C2K, WIMAX OFDMA, TD-SCDMA, 1xEVDO, DVB-T/H, DTMB
Notes	Since the result value is always calculated from acquisition data, the default value is arbitrary. Although the Preset/Default values are defined.
Preset	Result dependent on markers setup and signal source.
State Saved	No
Instrument S/W Revision	Prior to A.02.00

Properties

Accesses the marker properties menu.

Key Path	Marker
Instrument S/W Revision	Prior to A.02.00

Select Marker

Displays 12 markers available for selection.

Key Path	Marker
Instrument S/W Revision	Prior to A.02.00

Relative To

Selects the desired marker. The selected marker will be relative to its reference marker.

Remote Command	:CALCulate:ACPower:MARKer[1] 2 3 4 5 6 7 8 9 10 11 12:REference <integer> :CALCulate:ACPower:MARKer[1] 2 3 4 5 6 7 8 9 10 11 12:REference?
-----------------------	---

Example	CALC:ACP:MARK2:REF 6 CALC:ACP:MARK2:REF?
---------	---

Key Path	Marker, Properties
Mode	SA, WCDMA, C2K, WIMAX OFDMA, TD-SCDMA, 1xEVDO, DVB-T/H, DTMB
Notes	A marker cannot be relative to itself so that choice is grayed out, and if sent from SCPI generates error -221: "Settings conflict; marker cannot be relative to itself." When queried a single value will be returned (the specified marker numbers relative marker). You must be in the mode that includes ACP measurements to use this command. Use :INSTrument:SElect to set the mode.

ACP Measurement Marker

Preset	2 3 4 5 6 7 8 9 10 11 12 1
State Saved	Saved in instrument state.
Min	1
Max	12
Instrument S/W Revision	Prior to A.02.00

Marker Trace

Selects the trace that you want your marker to be placed on. A marker is associated with one and only one trace. This trace is used to determine the placement, result, and X Axis Scale of the marker. All markers have an associated trace, even **Fixed** markers; it is from that trace that they determine their attributes and behaviors, and it is to that trace that they go when they become Normal or Delta markers.

Remote Command	:CALCulate:ACPower:MARKer[1] 2 3 4 5 6 7 8 9 10 11 12:TRACe 1 2 3 :CALCulate:ACPower:MARKer[1] 2 3 4 5 6 7 8 9 10 11 12:TRACe?
Example	CALC:ACP:MARK2:TRAC 2 CALC:ACP:MARK2:TRAC?
Dependencies/Couplings	This is not affected by Auto Coupling. Sending the remote command causes the addressed marker to become selected.
Key Path	Marker, Properties
Mode	SA, WCDMA, C2K, WIMAX OFDMA, TD-SCDMA, 1xEVDO, DVB-T/H, DTMB
Notes	If the selected marker is Off, pressing Marker sets it to Normal and places it at the center of the screen on the trace determined by the Marker Trace rules. At the same time, Marker X Axis Value appears on the Active Function area. Default Active Function: the active function for the selected marker's current control mode. If the current control mode is Off, there is no active function and the active function is turned off. Active Function Display: the marker X axis value entered in the active function area will display the marker value to its full entered precision.
Preset	All Markers Off
State Saved	Saved in instrument state.
Range	1 2 3
Instrument S/W Revision	Prior to A.02.00

Couple Markers

When this function is On, moving any marker causes an equal X axis movement of every other marker which is not **Off**. By “equal X axis movement” we mean that we preserve the difference between each marker’s X axis value (in the fundamental x-axis units of the trace that marker is on) and the X axis value of the marker being moved (in the same fundamental x-axis units).

Remote Command	:CALCulate:ACPower:MARKer:COUple[:STATe] ON OFF 1 0 :CALCulate:ACPower:MARKer:COUple[:STATe]?
Example	CALC:ACP:MARK:COUP ON
Key Path	Marker
Mode	SA, WCDMA, C2K, WIMAX OFDMA, TD-SCDMA, 1xEVDO, DVB-T/H, DTMB
Preset	OFF
State Saved	Saved in instrument state.
Range	On Off
Instrument S/W Revision	Prior to A.02.00

Marker All Off

Turns all active markers off.

Remote Command	:CALCulate:ACPower:MARKer:AOFF
Example	CALC:ACP:MARK:AOFF
Key Path	Marker
Mode	SA, WCDMA, C2K, WIMAX OFDMA, TD-SCDMA, 1xEVDO, DVB-T/H, DTMB
Instrument S/W Revision	Prior to A.02.00

Marker Function

There are no 'Marker Functions' supported in ACP. The front-panel key will display a blank menu key when pressed.

Key Path	Front Panel
Instrument S/W Revision	Prior to A.02.00

Marker To

There is no 'Marker To' functionality supported in ACP. The front-panel key will display a blank menu key when pressed.

Key Path	Front Panel
Instrument S/W Revision	Prior to A.02.00

Meas

See “[Meas](#)” on page 1127 in the section "Common Measurement Functions" for more information.

Meas Setup

Displays the setup menu for the currently selected measurement. The functions included in the measurement setup menu include setting the parameters for the carriers, offsets, bandwidths, measurement methods and types. This menu also allows you to turn noise correction on and off.

Key Path	Front-panel key
Instrument S/W Revision	Prior to A.02.00

Average/Hold Number

Specifies the number of measurement averages used to calculate the measurement result. The average will be displayed at the end of each sweep. After the specified number of average counts, the average mode (termination control) setting determines the average action.

Remote Command	[:SENSe] :ACPower :AVERage :COUNT <integer> [:SENSe] :ACPower :AVERage :COUNT? [:SENSe] :ACPower :AVERage [:STATe] OFF ON 0 1 [:SENSe] :ACPower :AVERage [:STATe] ?
-----------------------	--

Example	ACP:AVER:COUN 250 ACP:AVER:COUN? ACP:AVER OFF ACP:AVER?
---------	--

Key Path	Meas Setup
Mode	SA, WCDMA, C2K, WIMAX OFDMA, TD-SCDMA, 1xEVDO, DVB-T/H, DTMB
Notes	You must be in the mode that includes ACP measurements to use this command. Use :INSTrument:SElect to set the mode.
Preset	10 ON
State Saved	Saved in instrument state.
Min	1
Max	1000
Instrument S/W Revision	Prior to A.02.00

Avg Mode

Enables you to set the averaging mode. This determines the averaging action after the specified number

ACP Measurement Meas Setup

of data acquisitions (average count) is reached.

When set to Exponential (Exp) the measurement averaging continues using the specified number of averages to compute each averaged value. The average will be displayed at the end of each sweep.

When set to Repeat, the measurement resets the average counter each time the specified number of averages is reached.

Remote Command	<code>[:SENSe] :ACPower :AVERage :TCONtrol EXPonential REPEAT</code> <code>[:SENSe] :ACPower :AVERage :TCONtrol ?</code>
Example	ACP:AVER:TCON EXP ACP:AVER:TCON?
Key Path	Meas Setup
Mode	SA, WCDMA, C2K, WIMAX OFDMA, TD-SCDMA, 1xEVDO, DVB-T/H, DTMB
Notes	You must be in the mode that includes ACP measurements to use this command. Use :INSTRument:SELect to set the mode.
Preset	EXPonential
State Saved	Saved in instrument state.
Range	Exp Repeat
Instrument S/W Revision	Prior to A.02.00

Carrier Setup

Accesses a menu that contains Carriers, Ref Carrier, Ref Car Freq, Ref Car Pwr and Configure Carriers.

Key Path	Meas Setup
Instrument S/W Revision	Prior to A.02.00

Carriers

Specifies the number of carriers to be measured.

Key Path	Meas Setup, Carrier Setup, Configure Carriers
Mode	SA, WCDMA, C2K, WIMAX OFDMA, 1xEVDO, TD-SCDMA, DVB-T/H, DTMB
Remote Command	<code>[:SENSe] :ACPower :CARRier [1] 2 :COUNT <integer></code> <code>[:SENSe] :ACPower :CARRier [1] 2 :COUNT ?</code>
Example	ACP:CARR:COUN 1 ACP:CARR:COUN?

Notes	Carrier sub op code. 1 for BTS, 2 for MS. Default is BTS. You must be in the mode that includes ACP measurements to use this command. Use :INSTrument:SElect to set the mode.
Dependencies/Couplings	When Number of Carriers is 1, Ref Carrier is grayed out. Changing this parameter might affect to the Span. .
Preset	1
State Saved	Saved in instrument state.
Min	1
Max	12
Instrument S/W Revision	Prior to A.02.00

Ref Carrier

Sets the reference carrier. Relative power measurements are made from the reference carrier.

If set to Auto, the measurement selects the carrier with the highest power as the reference carrier and the Ref Carrier parameter is updated. If a value is entered when Ref Carrier Mode is set to Auto, the mode changes to Man.

If set to Man, the value that you enter for the Ref Carrier is used as the reference carrier.

Remote Command

```
[ :SENSe]:ACPower:CARRier[1]|2:RCARrier <integer>
[ :SENSe]:ACPower:CARRier[1]|2:RCARrier?
[ :SENSe]:ACPower:CARRier[1]|2:RCARrier:AUTO OFF|ON|0|1
[ :SENSe]:ACPower:CARRier[1]|2:RCARrier:AUTO?
```

Example

```
ACP:CARR:RCAR 1
ACP:CARR:RCAR?
ACP:CARR:RCAR:AUTO OFF
ACP:CARR:RCAR:AUTO?
```

Dependencies/Couplings

If there is only one carrier, this key will be grayed out.

If you enter a carrier value that is currently configured as having no power present, that carrier will be changed to having power present.

If you enter a ref carrier this parameter will be set to manual.

Key Path **Meas Setup, Carrier Setup**

Mode SA, WCDMA, C2K, WIMAX OFDMA, 1xEVDO, TD-SCDMA, DVB-T/H, DTMB

Notes

Carrier sub op code. 1 for BTS, 2 for MS. Default is BTS.

You must be in the mode that includes ACP measurements to use this command. Use :INSTrument:SElect to set the mode.

ACP Measurement Meas Setup

Preset	Auto determined
State Saved	Saved in instrument state.
Min	1
Max	Number of available carriers
Instrument S/W Revision	Prior to A.02.00

Ref Car Freq

Sets the reference carrier frequency.

Remote Command	<pre>[:SENSe]:ACPower:CARRier[1] 2:RCFRequency <freq> [:SENSe]:ACPower:CARRier[1] 2:RCFRequency? [:SENSe]:ACPower:CARRier[1] 2:RCFRequency:AUTO OFF ON 0 1 [:SENSe]:ACPower:CARRier[1] 2:RCFRequency:AUTO?</pre>
Example	<pre>ACP:CARR:RCFR 250 MHz ACP:CARR:RCFR? ACP:CARR:RCFR:AUTO OFF ACP:CARR:RCFR:AUTO?</pre>
Dependencies/Couplings	<p>Coupled to the Center Frequency.</p> <p>If the center frequency changes, the Ref Carrier Frequency is calculated using the following three steps;</p> $\text{Ref Freq1} = \text{Ctr Freq} - (\text{Total of all Carrier Widths} / 2)$ $\text{Ref Freq2} = \text{Ref Freq1} + (\text{Total of all Carrier Widths up to Ref Carrier})$ $\text{Ref Freq} = \text{Ref Freq2} + (0.5 * \text{Carrier Width of Ref Carrier})$ <p>If reference carrier frequency changes the Center Frequency is calculated using the following three steps;</p> $\text{Ctr Freq1} = \text{Ref Freq} - (0.5 * \text{Carrier Width of Ref Carrier})$ $\text{Ctr Freq2} = \text{Ctr Freq1} - (\text{Total of all Carrier Widths up to Ref Carrier})$ $\text{Ctr Freq} = \text{Ctr Freq2} + (\text{Total of all Carrier Widths} / 2)$ <p>This ensures that the carriers are always centered on the screen.</p> <p>If there is only one carrier present the Reference Carrier Frequency will be the same as the Center Frequency.</p>
Key Path	Meas Setup, Carrier Setup
Mode	SA, WCDMA, C2K, WIMAX OFDMA, 1xEVDO, TD-SCDMA, DVB-T/H, DTMB

Notes	Carrier sub op code. 1 for BTS, 2 for MS. Default is BTS. You must be in the mode that includes ACP measurements to use this command. Use :INSTrument:SElect to set the mode.
Preset	Calculated based on the current Center Frequency
State Saved	Saved in instrument state.
Min	-79.999995 MHz
Max	Hardware Dependent: Option 503 = 3.699999995 GHz Option 508 = 8.499999995 GHz Option 513 = 13.799999995 GHz Option 526 = 26.999999995 GHz
Instrument S/W Revision	Prior to A.02.00

Power Ref

Sets the multi-carrier power reference.

When set to Auto, the carrier power result reflects the measured power value in the selected reference carrier .

When set to Man, the result is referenced to the last measured value, or you may specify the reference for the multi-carrier power measurement. Relative values are displayed, referenced to the “Power Reference” value.

Remote Command	[:SENSE]:ACPpower:CARRier[1] 2[:POWER] <real> [:SENSE]:ACPpower:CARRier[1] 2[:POWER]? [:SENSE]:ACPpower:CARRier[1] 2:AUTO[:STATE] OFF ON 0 1 [:SENSE]:ACPpower:CARRier[1] 2:AUTO[:STATE]?
-----------------------	--

Example	ACP:CARR 10 ACP:CARR? ACP:CARR:AUTO OFF ACP:CARR:AUTO?
---------	---

Dependencies/Couplings	See Notes
Key Path	Meas Setup, Carrier Setup
Mode	SA, WCDMA, C2K, WIMAX OFDMA, TD-SCDMA, DVB-T/H, DTMB

ACP Measurement Meas Setup

Notes	<p>Although the default value is defined, the value is recalculated by the measurement result just after measurement.</p> <p>Carrier sub op code. 1 for BTS, 2 for MS. Default is BTS.</p> <p>You must be in the mode that includes ACP measurements to use this command. Use :INSTrument:SELEct to set the mode.</p> <p>This key is available only when the Meas Type is TPRef.</p>
Preset	0.0
	ON
State Saved	Saved in instrument state.
Min	-200 dBm
Max	200 dBm
Instrument S/W Revision	Prior to A.02.00

PSD Ref

Sets the power spectral density in the carrier (main channel) that is used to compute the relative power spectral density values for the offsets when Meas Type is set to PSD Ref. When the PSD Ref state is set to Auto, this will be set to the measured carrier power spectral density.

Remote Command	<pre>[:SENSE]:ACPower:CARRIER[1] 2:CPSD <real></pre> <pre>[:SENSE]:ACPower:CARRIER[1] 2:CPSD?</pre>
Example	<pre>ACP:CARR:CPSD 25</pre> <pre>ACP:CARR:CPSD?</pre>
Dependencies/Couplings	<p>This key is available only when the Meas Type is PSDRef.</p> <p>The value of PSD Ref is automatically converted when PSD Unit is changed.</p>
Key Path	Meas Setup, Carrier Setup
Mode	SA, WCDMA, C2K, WIMAX OFDMA, TD-SCDMA, DVB-T/H, DTMB
Notes	<p>Although the default value is defined, the value is recalculated by the measurement result just after measurement.</p> <p>Carrier sub op code. 1 for BTS, 2 for MS. Default is BTS.</p> <p>You must be in the mode that includes ACP measurements to use this command. Use :INSTrument:SELEct to set the mode.</p>
Preset	0.0
State Saved	Saved in instrument state.
Min	-999
Max	999
Instrument S/W Revision	Prior to A.02.00

Configure Carriers

Accesses a menu that contains Carrier, Carrier Pwr Present, Carrier Width and Carrier Integ BW parameters.

Key Path	Meas Setup, Carrier Setup
Instrument S/W Revision	Prior to A.02.00

Carrier Selects the carrier to configure for the current measurement.

Dependencies/Couplings	Max value is the number of available carriers, so this value might change when the number of carriers is changed.
Key Path	Meas Setup, Carrier Setup, Configure Carriers
Mode	SA, WCDMA, C2K, WIMAX OFDMA, 1xEVDO, TD-SCDMA, DVB-T/H, DTMB
Preset	1
State Saved	No
Min	1
Max	Number of available carriers
Instrument S/W Revision	Prior to A.02.00

Carrier Coupling Couples carrier settings to carrier #1. The coupled parameters are Carrier Power Present, Carrier Spacing, Measurement Noise Bandwidth, Method and Filter Alpha.

Remote Command	[:SENSE]:ACPower:CARRIER[1] 2:LIST:COUPLE OFF ON 0 1, ... [:SENSE]:ACPower:CARRIER[1] 2:LIST:COUPLE?
Example	ACP:CARR:LIST:COUP OFF ACP:CARR:LIST:COUP?
Dependencies/Couplings	When Couple is selected, the carrier settings are coupled to carrier #1. Coupled parameters are Carrier Power Present, Carrier Spacing, Measurement Noise Bandwidth, Method and Filter Alpha. When a setting is changed, the couple is set to Man automatically. Carrier #1 is always set to couple and cannot be changed. Couple/Man selection on the Carrier key is not displayed when selected carrier number is #1.
Key Path	Meas Setup, Carrier Setup, Configure Carriers
Mode	SA, WCDMA, C2K, WIMAX OFDMA, 1xEVDO, TD-SCDMA, DVB-T/H, DTMB

ACP Measurement Meas Setup

Notes	Carrier sub op code. 1 for BTS, 2 for MS. Default is BTS. You must be in the mode that includes ACP measurements to use this command. Use :INSTrument:SELEct to set the mode.
Preset	ON
State Saved	Saved in instrument state.
Range	Couple Man
Instrument S/W Revision	Prior to A.02.00

Carrier Pwr Present Configures the carriers for this measurement. It allows spaces to be inserted between carriers. Carriers with the power present parameter set to Yes are carriers, and those with the power present parameter set to No are spaces. Each carrier power present is set to Yes or No. The individual carriers can be set by selecting the desired carrier on the carrier menu key using the up down arrows, the knob, or numeric keypad, then toggling the carrier power present using the carrier power present menu key.

The query for this parameter returns the current values for all of the carriers. If a carrier is defined as having no power present, the power displayed will be relative to the reference carrier, otherwise the absolute power will be displayed.

If you change the carrier power present to no and that carrier is currently configured as the reference carrier, the next carrier to the left (or the right if there are no carriers to the left) will be assigned as the reference carrier. This also applies to the scenario where there are only two carriers configured as having power present and you configure only one carrier to have no power present.

Remote Command	<code>[:SENSE]:ACPpower:CARRIER[1] 2:LIST:PPresent YES NO, ...</code> <code>[:SENSE]:ACPpower:CARRIER[1] 2:LIST:PPresent?</code>
Example	ACP:CARR2:LIST:PPR YES ACP:CARR2:LIST:PPR?
Dependencies/Couplings	If there are only one or two carriers, this key will be greyed out as they both need to have power present. Coupled to the number of carriers. When the SCPI command is sent, the number of carriers will be set to the number of entries in the parameter list.
Key Path	Meas Setup, Carrier Setup, Configure Carriers
Mode	SA, WCDMA, C2K, WIMAX OFDMA, 1xEVDO, TD-SCDMA, DVB-T/H, DTMB
Notes	Carrier sub op code. 1 for BTS, 2 for MS. Default is BTS. When setting these values remotely, the position in the list sent corresponds to the carrier. Missing values are not permitted, therefore if you want to change values 2 and 6 you must send all values up to 6. Subsequent values will remain unchanged, unless the number of values sent is greater than the number of carriers, then subsequent values will be ignored.
Preset	YES

State Saved	Saved in instrument state.
Range	Yes No
Instrument S/W Revision	Prior to A.02.00

Carrier Spacing Sets the width of the carrier spacing. This will be the value applied to all the current slots, whether they are carriers or spaces.

Enter each carrier spacing value individually by selecting the desired carrier on the carrier menu key using the up down arrows, the knob, or the numeric keypad, then enter the carrier width using the carrier spacing menu key.

Remote Command	<code>[:SENSe] :ACPpower :CARRier [1] 2 :LIST :WIDTh <bandwidth> , ...</code> <code>[:SENSe] :ACPpower :CARRier [1] 2 :LIST :WIDTh?</code>
Example	ACP:CARR2:LIST:WIDT 25kHz ACP:CARR2:LIST:WIDT?
Dependencies/Couplings	Coupled to the number of carriers. When the SCPI command is sent, the number of carriers will be set to the number of entries in the parameter list. Changing Carrier Spacing might affect the Span.
Key Path	Meas Setup, Carrier Setup, Configure Carriers
Mode	SA, WCDMA, C2K, WIMAX OFDMA, 1xEVDO, TD-SCDMA, DVB-T/H, DTMB
Notes	Carrier sub op code. 1 for BTS, 2 for MS. Default is BTS. When setting these values remotely, the position in the list sent corresponds to the carrier. Missing values are not permitted, therefore if you want to change values 2 and 6 you must send all values up to 6. Subsequent values will remain unchanged, unless the number of values sent is greater than the number of carriers, then subsequent values will be ignored. You must be in the mode that includes ACP measurements to use this command. Use :INSTrument:SElect to set the mode.
Preset	SA, WCDMA: 5 MHz WIMAX OFDMA: 10MHz C2K: 1.25MHz 1xEVDO: 1.25MHz TD-SCDMA: 1.6MHz DVB-T/H: 8MHz DTMB: 8MHz
State Saved	Saved in instrument state.
Min	0 Hz
Max	1 GHz

ACP Measurement Meas Setup

Instrument S/W Revision Prior to A.02.00

Measurement Noise Bandwidth Specifies the Measurement Noise Bandwidth used to calculate the power in the carriers.

Each Measurement Noise Bandwidth value is entered individually by selecting the desired carrier on the carrier menu key using the up down arrows, the knob, or the numeric keypad. Then enter the measurement noise bandwidth using the measurement noise bandwidth softkey.

Remote Command	<pre>[:SENSe]:ACPower:CARRier[1] 2:LIST:BANDwidth[:INTEgrati on] <freq>, ... [:SENSe]:ACPower:CARRier[1] 2:LIST:BANDwidth[:INTEgrati on]?</pre>
Example	<pre>ACP:CARR2:LIST:BAND 25kHz ACP:CARR2:LIST:BAND?</pre>
Dependencies/Couplings	Coupled to the number of carriers. When the SCPI command is sent, the number of carriers is set to the number of entries in the parameter list.
Key Path	Meas Setup, Carrier Setup, Configure Carriers
Mode	SA, WCDMA, C2K, WIMAX OFDMA, TD-SCDMA, 1xEVDO, DVB-T/H, DTMB
Notes	<p>In the WCDMA mode, the preset/default value is defined as 3.84 MHz. But internally, 4.6848 MHz is used as the default value.</p> <p>Carrier sub op code. 1 for BTS, 2 for MS. Default is BTS.</p> <p>When setting these values remotely, the position in the list sent corresponds to the carrier. Missing values are not permitted, therefore if you want to change values 2 and 6 you must send all values up to 6. Subsequent values will remain unchanged, unless the number of values sent is greater than the number of carriers, then subsequent values will be ignored.</p> <p>You must be in the mode that includes ACP measurements to use this command. Use :INSTrument:SElect to set the mode.</p>
Preset	<pre>SA: 2 MHz WCDMA: 3.84 MHz WIMAX OFDMA: 10MHz C2K: 1.23MHz TD-SCDMA: 1.28MHz 1xEVDO: 1.23MHz DVB-T/H: 7.61MHz DTMB: 7.56MHz</pre>
State Saved	Saved in instrument state.
Min	10 Hz

Max 1 GHz
Instrument S/W Revision Prior to A.02.00

Method Accesses the carrier configuration method settings.

Remote Command [:SENSe]:ACPower:CARRier[1]|2:LIST:METHOD IBW|RRC, ...
[:SENSe]:ACPower:CARRier[1]|2:LIST:METHOD?

Example ACP:CARR2:LIST:METH RRC
ACP:CARR2:LIST:METH?

Key Path **Meas Setup, Carrier Setup, Configure Carriers**

Mode SA, WCDMA, TD-SCDMA, DVB-T/H, DTMB

Notes You must be in the mode that includes ACP measurements to use this command. Use :INSTrument:SElect to set the mode.

Preset SA: IBW
WCDMA: RRC
WIMAX OFDMA: IBW
TD-SCDMA: RRC
DVB-T/H: IBW
DTMB: RRC

State Saved Saved in instrument state.

Range IntegBW|RRC Weight

Instrument S/W Revision Prior to A.02.00

Filter Alpha Inputs the alpha value for the filter used in the current carrier configuration.

Remote Command [:SENSe]:ACPower:CARRier[1]|2:LIST:FILTer:ALPHA <real>, ...
[:SENSe]:ACPower:CARRier[1]|2:LIST:FILTer:ALPHA?

Example ACP:CARR2:LIST:FILT:ALPH 0.5
ACP:CARR2:LIST:FILT:ALPH?

Key Path **Meas Setup, Carrier Setup, Configure Carriers**

Mode SA, WCDMA, TD-SCDMA, DVB-T/H, DTMB

Notes You must be in the mode that includes ACP measurements to use this command. Use :INSTrument:SElect to set the mode.

Preset 0.22
C2K: No

ACP Measurement Meas Setup

State Saved	Saved in instrument state.
Min	0.01
Max	1.0
Instrument S/W Revision	Prior to A.02.00

Offset/Limits

Accesses a menu of functions that contains Offset, Offset Freq/Offset To Edge, Offset Integ BW, Upper Offset Limit and Lower Offset parameters.

Key Path	Meas Setup
Instrument S/W Revision	Prior to A.02.00

Offset

Selects the offset to configure.

Key Path	Meas Setup, Offset/Limit
Mode	SA, WCDMA, C2K, WIMAX OFDMA, TD-SCDMA, 1xEVDO, DVB-T/H, DTMB
Preset	A
State Saved	Saved in instrument state.
Range	A B C D E F
Instrument S/W Revision	Prior to A.02.00

Offset Freq

This parameter determines the frequency difference between the center of the main channel and the center of the carrier.

Each Offset Freq state value is entered individually by selecting the desired carrier on the carrier menu key using the up down arrows, RPG or numeric keypad. Then enter the Offset Freq State using the Offset Frequency softkey.

The list contains up to six (6) entries, depending on the mode selected, for offset frequencies. Each offset frequency in the list corresponds to a reference bandwidth in the bandwidth list.

An offset frequency of zero turns the display of the measurement for that offset off, but the measurement is still made and reported. You can turn off (not use) specific offsets with the [:SENSe]:ACP:OFFSet:LIST:STATe command

Turning the offset off has the same effect as setting the frequency of the offset to 0 Hz and will cause it to

be removed from the results screen.

Remote Command	<pre>[:SENSe]:ACPower:OFFSet[1] 2:LIST[:FREQuency] <freq>, <freq>, <freq>, <freq>, <freq> [:SENSe]:ACPower:OFFSet[1] 2:LIST[:FREQuency]? [:SENSe]:ACPower:OFFSet[1] 2:LIST:STATe OFF ON 0 1, OFF ON 0 1, OFF ON 0 1, OFF ON 0 1, OFF ON 0 1, OFF ON 0 1 [:SENSe]:ACPower:OFFSet[1] 2:LIST:STATe?</pre>
Example	<pre>ACP:OFFS1:LIST 0,0,0,0,0,0 ACP:OFFS1:LIST? ACP:OFFS2:LIST:STAT 1,1,0,0,0,0 ACP:OFFS2:LIST:STAT?</pre>
Dependencies/Couplings	Changing Offset Frequency might affect the Span. See the Span key section for details.
Key Path	Meas Setup, Offset/Limit
Mode	SA, WCDMA, C2K, WIMAX OFDMA, TD-SCDMA, 1xEVDO, DVB-T/H, DTMB
Notes	<p>The label for this menu key will change depending on the currently selected radio standard or mode. For cdma2000 the label for the menu key will be Offset to Edge. For all other supported standards the label will be Offset Freq.</p> <p>When setting these values remotely, the position in the list sent corresponds to the offset. Missing values are not permitted, unless the number of values sent is greater than the number of carriers, then subsequent values will be ignored.</p> <p>Offset sub op code. 1 for BTS, 2 for MS. Default is BTS.</p> <p>You must be in the mode that includes ACP measurements to use this command. Use :INSTRument:SElect to set the mode.</p>

ACP Measurement Meas Setup

Preset	SA: 3 MHz, 0 Hz, 0 Hz, 0 Hz, 0 Hz, 0 Hz 3 MHz, 0 Hz, 0 Hz, 0 Hz, 0 Hz, 0 Hz WCDMA: 5.0 MHz, 10.0 MHz, 0 Hz, 0 Hz, 0 Hz, 0 Hz 5.0 MHz, 10.0 MHz, 0 Hz, 0 Hz, 0 Hz, 0 Hz WIMAX OFDMA: 10MHz, 20MHz, 0Hz, 0Hz, 0Hz, 0Hz 10MHz, 20MHz, 0Hz, 0Hz, 0Hz, 0Hz C2K:765KHz, 1.995MHz, 0Hz, 0Hz, 0Hz, 0Hz 900KHz, 1.995MHz, 0Hz, 0Hz, 0Hz, 0Hz TD-SCDMA: 1.6 MHz, 3.2 MHz, 0 Hz, 0 Hz, 0 Hz, 0 Hz 1.6 MHz, 3.2 MHz, 0 Hz, 0 Hz, 0 Hz, 0 Hz 1xEVDO: 765KHz, 1.995MHz, 3.125MHz, 4.000MHz, 7.500MHz, 7.500MHz 765KHz, 1.995MHz, 3.125MHz, 4.000MHz, 7.500MHz, 7.500MHz DVB-T/H: 8MHz, 16MHz, 0Hz, 0Hz, 0Hz, 0Hz 0Hz, 0Hz, 0Hz, 0Hz, 0Hz, 0Hz DTMB: 8MHz, 16MHz, 24MHz, 32MHz, 0Hz, 0Hz 0Hz, 0Hz, 0Hz, 0Hz, 0Hz, 0Hz SA: ON, OFF, OFF, OFF, OFF, OFF ON, OFF, OFF, OFF, OFF, OFF WCDMA: ON, ON, OFF, OFF, OFF, OFF ON, ON, OFF, OFF, OFF, OFF WIMAX OFDMA: ON, ON, OFF, OFF, OFF, OFF ON, ON, OFF, OFF, OFF, OFF TD-SCDMA: ON, ON, OFF, OFF, OFF, OFF ON, ON, OFF, OFF, OFF, OFF DVB-T/H: ON, ON, OFF, OFF, OFF, OFF ON, ON, OFF, OFF, OFF, OFF DTMB: ON, ON, OFF, OFF, OFF, OFF ON, ON, OFF, OFF, OFF, OFF CDMA1xEVDO: ON,ON,OFF,OFF,OFF,OFF ON,ON,OFF,OFF,OFF,OFF
State Saved	Saved in instrument state.
Min	0 Hz
Max	500 MHz
Instrument S/W Revision	Prior to A.02.00

Offset Integ BW

Sets the Integration Bandwidth for the offsets. If there is more than one bandwidth, the list must contain six (6) entries. Each resolution bandwidth in the list corresponds to an offset frequency in the list defined by [:SENSe]:ACP:OFFSet[n]:LIST[:FREQuency].

Enter each value individually by selecting the desired offset on the offset menu key using the up down arrows, the knob, or the numeric keypad, then enter the Offset Integration Bandwidth using the Offset Integration Bandwidth menu key.

You can turn off (not use) specific offsets with the [:SENSe]:ACP:OFFSet[n]:LIST:STATe command."

Remote Command	[:SENSe]:ACP:Power:OFFSet[1] 2:LIST:BANDwidth[:INTEgratio n] <bandwidth>, <bandwidth>, <bandwidth>, <bandwidth>, <bandwidth>, <bandwidth> [:SENSe]:ACP:Power:OFFSet[1] 2:LIST:BANDwidth[:INTEgratio n]?
Example	ACP:OFFS2:LIST:BAND 2MHz,2MHz,2MHz,2MHz,2MHz,2MHz ACP:OFFS2:LIST:BAND?
Dependencies/Couplings	Changing Offset Integ BW might affect to the Span. See Span section for details.
Key Path	Meas Setup, Offset/Limit
Mode	SA, WCDMA, C2K, WIMAX OFDMA, TD-SCDMA, 1xEVDO, DVB-T/H, DTMB
Notes	When setting these values remotely, the position in the list sent corresponds to the offset. Missing values are not permitted i.e. if you want to change values 2 you must send all values up to 2. Subsequent values will remain unchanged, unless the number of values sent is greater than the number of carriers, then subsequent values will be ignored. Offset sub op code. 1 for BTS, 2 for MS. Default is BTS. You must be in the mode that includes ACP measurements to use this command. Use :INSTrument:SElect to set the mode.
Preset	SA: 2 MHz, 2 MHz, 2 MHz, 2 MHz, 2 MHz, 2 MHz 2 MHz, 2 MHz, 2 MHz, 2 MHz, 2 MHz, 2 MHz WCDMA: 3.84 MHz, 3.84 MHz, 3.84 MHz, 3.84 MHz, 3.84 MHz, 3.84 MHz 3.84 MHz, 3.84 MHz, 3.84 MHz, 3.84 MHz, 3.84 MHz, 3.84 MHz WIMAX OFDMA: 10MHz, 10MHz, 10MHz, 10MHz, 10MHz, 10MHz 10MHz, 10MHz, 10MHz, 10MHz, 10MHz, 10MHz C2K: 30KHz, 30KHz, 30KHz, 30KHz, 30KHz, 30KHz 30KHz, 30KHz, 30KHz, 30KHz, 30KHz, 30KHz TD-SCDMA: 1.28 MHz, 1.28 MHz, 1.28 MHz, 1.28 MHz, 1.28 MHz, 1.28 MHz 1xEVDO: C2K: 30KHz, 30KHz, 30KHz, 30KHz, 30KHz, 30KHz 30KHz, 30KHz, 30KHz, 30KHz, 30KHz, 30KHz DVB-T/H: 7.61MHz, 7.61MHz, 7.61MHz, 7.61MHz, 7.61MHz, 7.61MHz 7.61MHz, 7.61MHz, 7.61MHz, 7.61MHz, 7.61MHz, 7.61MHz DTMB: 7.56MHz, 7.56MHz, 7.56MHz, 7.56MHz, 7.56MHz, 7.56MHz 7.56MHz, 7.56MHz, 7.56MHz, 7.56MHz, 7.56MHz, 7.56MHz
State Saved	Saved in instrument state.
Min	10 Hz
Max	1 GHz

**ACP Measurement
Meas Setup**

Instrument S/W Revision Prior to A.02.00

Offset BW

Accesses the offset bandwidth menu.

Key Path **Meas Setup, Offset/Limit**

Instrument S/W Revision Prior to A.02.00

Res BW

Sets the resolution bandwidth. If an unavailable bandwidth is entered with the numeric keypad, the closest available bandwidth is selected.

Remote Command [:SENSe]:ACPower:OFFSet[1]|2:LIST:BANDwidth:RESolution
<bandwidth>, <bandwidth>, <bandwidth>, <bandwidth>,
<bandwidth>, <bandwidth>

[:SENSe]:ACPower:OFFSet[1]|2:LIST:BANDwidth:RESolution?

[:SENSe]:ACPower:OFFSet[1]|2:LIST:BANDwidth:RESolution:
AUTO ON|OFF|1|0, ON|OFF|1|0, ON|OFF|1|0, ON|OFF|1|0,
ON|OFF|1|0, ON|OFF|1|0

[:SENSe]:ACPower:OFFSet[1]|2:LIST:BANDwidth:RESolution:
AUTO?

Example ACP:OFFS2:LIST:BAND:RES
220kHz,220kHz,220kHz,220kHz,220kHz,220kHz

ACP:OFFS2:LIST:BAND:RES?

ACP:OFFS2:LIST:BAND:RES:AUTO 1,1,1,1,1,1

ACP:OFFS2:LIST:BAND:RES:AUTO?

Dependencies/Couplings When Res BW Mode is AUTO, this value is exactly same as Res BW under BW key. And when this value is changed by user, Res BW Mode is also changed to Man.

Key Path **Meas Setup, Offset/Limits**

Mode SA, WCDMA, C2K, WIMAX OFDMA, TD-SCDMA, 1xEVDO, DVB-T/H, DTMB

Notes This key is available only in the IBW mode.

Offset sub op code. 1 for BTS, 2 for MS. Default is BTS.

You must be in the mode that includes ACP measurements to use this command. Use :INSTrument:SElect to set the mode.

Preset	SA: 220 kHz, 220 kHz, 220 kHz, 220 kHz, 220 kHz, 220 kHz WCDMA: 100 kHz, 100 kHz, 100 kHz, 100 kHz, 100 kHz, 100 kHz WIMAX OFDMA: 100KHz, 100KHz, 100KHz, 100KHz, 100KHz, 100KHz C2K: Method:RBW 30K Method: IBW C2K: 15KHz, 15KHz, 15KHz, 15KHz,15KHz, 15KHz 15KHz, 15KHz, 15KHz, 15KHz,15KHz, 15KHz TD-SCDMA: 30 kHz, 30 kHz, 30 kHz, 30 kHz, 30 kHz, 30 kHz 1xEVDO: 3KHz, 30KHz, 30KHz, 30KHz,30KHz, 30KHz 3KHz, 30KHz, 30KHz, 30KHz,30KHz, 30KHz DVB-T/H: 39KHz, 39KHz, 39KHz, 39KHz,39KHz, 39KHz 39KHz, 39KHz, 39KHz, 39KHz, 39KHz, 39KHz DTMB: 39KHz, 39KHz, 39KHz, 39KHz,39KHz, 39KHz 39KHz, 39KHz, 39KHz, 39KHz, 39KHz, 39KHz 1, 1, 1, 1, 1, 1
State Saved	Saved in instrument state.
Min	1 Hz
Max	8 MHz
Instrument S/W Revision	Prior to A.02.00

Video BW

Enables you to change the analyzer post-detection filter (VBW).

Remote Command	[:SENSE]:ACPower:OFFSet[1] 2:LIST:BANDwidth:VIDeo <freq>, <freq>, <freq>, <freq>, <freq>, <freq> [:SENSE]:ACPower:OFFSet[1] 2:LIST:BANDwidth:VIDeo? [:SENSE]:ACPower:OFFSet[1] 2:LIST:BANDwidth:VIDeo:AUTO OFF ON 0 1, OFF ON 0 1, OFF ON 0 1, OFF ON 0 1, OFF ON 0 1, OFF ON 0 1 [:SENSE]:ACPower:OFFSet[1] 2:LIST:BANDwidth:VIDeo:AUTO?
Example	ACP:OFFS2:LIST:BAND:VID 5MHz,5MHz,5MHz,5MHz,5MHz,5MHz ACP:OFFS2:LIST:BAND:VID? ACP:OFFS2:LIST:BAND:VID:AUTO 0,0,0,0,1,1 ACP:OFFS2:LIST:BAND:VID:AUTO?
Key Path	Meas Setup, Offset/Limit, Offset BW

ACP Measurement Meas Setup

Mode	SA, WCDMA, C2K, WIMAX OFDMA, TD-SCDMA, 1xEVDO, DVB-T/H, DTMB
Notes	The values shown in this table reflect the conditions after a Mode Preset. Offset sub op code. 1 for BTS, 2 for MS. Default is BTS. You must be in the mode that includes ACP measurements to use this command. Use :INSTrument:SELEct to set the mode. .
Preset	SA: 22kHz, 22kHz, 22kHz, 22kHz, 22kHz, 22kHz WCDMA, WIMAX OFDMA: 1MHz, 1MHz, 1MHz, 1MHz, 1MHz, 1MHz C2K: 150KHz, 150KHz, 150KHz, 150KHz, 150KHz, 150KHz 150KHz, 150KHz, 150KHz, 150KHz, 150KHz TD-SCDMA: 300kHz, 300kHz, 300kHz, 300kHz, 300kHz, 300kHz 1xEVDO: 30KHz, 300KHz, 300KHz, 300KHz, 300KHz, 300KHz 30KHz, 300KHz, 300KHz, 300KHz, 300KHz DVB-T/H: 390KHz, 390KHz, 390KHz, 390KHz,390KHz, 390KHz 390KHz, 390KHz, 390KHz, 390KHz, 390KHz DTMB: 390KHz, 390KHz, 390KHz, 390KHz,390KHz, 390KHz 390KHz, 390KHz, 390KHz, 390KHz, 390KHz ON, ON, ON, ON, ON, ON
State Saved	Saved in instrument state.
Min	1 Hz
Max	50 MHz
Instrument S/W Revision	Prior to A.02.00

RBW Control

Accesses the resolution bandwidth control menu.

Key Path	Meas Setup, Offset/Limit, Offset BW
Instrument S/W Revision	Prior to A.02.00

Filter Type

Selects the type of bandwidth filter that is used.

Remote Command	[:SENSe]:ACPpower:OFFSet[1] 2:LIST:BANDwidth:SHAPE GAUSSian FLATtop, GAUSSian FLATtop, GAUSSian FLATtop, GAUSSian FLATtop, GAUSSian FLATtop, GAUSSian FLATtop [:SENSe]:ACPpower:OFFSet[1] 2:LIST:BANDwidth:SHAPE?
-----------------------	--

Example	ACP:OFFS2:LIST:BAND:SHAP FLAT,GAUS,GAUS,GAUS,GAUS,GAUS ACP:OFFS2:LIST:BAND:SHAP?
Dependencies/Couplings	See the description above
Key Path	Meas Setup, Offset/Limit, Offset BW, RBW Control
Mode	SA, WCDMA, C2K, WIMAX OFDMA, TD-SCDMA, 1xEVDO, DVB-T/H, DTMB
Notes	Offset sub op code. 1 for BTS, 2 for MS. Default is BTS. You must be in the mode that includes ACP measurements to use this command. Use :INSTrument:SElect to set the mode.
Preset	GAUSSian, GAUSSian, GAUSSian, GAUSSian, GAUSSian, GAUSSian
State Saved	Saved in instrument state.
Range	GAUSSian FLATtop
Instrument S/W Revision	Prior to A.02.00

Filter BW

Selects a Gaussian filter based on its –3 dB (Normal) bandwidth or its –6 dB bandwidth.

Remote Command	[:SENSe] :ACPpower :OFFSet [1] 2 :LIST :BANDwidth :TYPE DB3 DB6 , DB3 DB6 , DB3 DB6 , DB3 DB6 , DB3 DB6 , DB3 DB6 [:SENSe] :ACPpower :OFFSet [1] 2 :LIST :BANDwidth :TYPE?
Example	ACP:OFFS2:LIST:BAND:TYPE DB3,DB3,DB3,DB3,DB3,DB3 ACP:OFFS2:LIST:BAND:TYPE?
Dependencies/Couplings	Grayed out unless the Gaussian filter type is selected
Key Path	Meas Setup, Offset/Limit, Offset BW, RBW Control
Mode	SA, WCDMA, C2K, WIMAX OFDMA, TD-SCDMA, 1xEVDO, DVB-T/H, DTMB
Notes	Offset sub op code. 1 for BTS, 2 for MS. Default is BTS. You must be in the mode that includes ACP measurements to use this command. Use :INSTrument:SElect to set the mode.
Preset	DB3, DB3, DB3, DB3, DB3, DB3
State Saved	Saved in instrument state.
Range	–3 dB (Normal) –6 dB
Instrument S/W Revision	Prior to A.02.00

Abs Limit

Enters an absolute limit value, which sets the absolute amplitude levels to test against for each of the

ACP Measurement Meas Setup

custom offsets. The list must contain six (6) entries. If there is more than one offset, the offset closest to the carrier channel is the first one in the list. [:SENSe]:ACP:OFFSet[n]:LIST:TEST selects the type of testing to be done at each offset.

You can turn off (not use) specific offsets with the [:SENSe]:ACP:OFFSet[n]:LIST:STATe command.

The query returns the six (6) sets of real numbers that are the current absolute amplitude test limits.

Remote Command	[:SENSe]:ACP:Power:OFFSet[1] 2:LIST:ABSolute <real>, <real>, <real>, <real>, <real> [:SENSe]:ACP:Power:OFFSet[1] 2:LIST:ABSolute?
Example	ACP:OFFS2:LIST:ABS -10,-10,-10,-10,-10,-10 ACP:OFFS2:LIST:ABS?
Key Path	Meas Setup, Offset/Limit
Mode	SA, WCDMA, C2K, WIMAX OFDMA, TD-SCDMA, 1xEVDO, DVB-T/H, DTMB
Notes	Offset sub op code. 1 for BTS, 2 for MS. Default is BTS. You must be in the mode that includes ACP measurements to use this command. Use :INSTrument:SELEct to set the mode.
Preset	SA: 0dBm, 0 dBm, 0 dBm, 0 dBm, 0 dBm, 0 dBm 0dBm, 0 dBm, 0 dBm, 0 dBm, 0 dBm, 0 dBm WCDMA: 50 dBm, 50 dBm, 50 dBm, 50 dBm, 50 dBm, 50 dBm 50 dBm, 50 dBm, 50 dBm, 50 dBm, 50 dBm C2K: 50 dBm, 50 dBm, 50 dBm, 50 dBm, 50 dBm, 50 dBm 50 dBm, 50 dBm, 50 dBm, 50 dBm, 50 dBm WIMAX OFDMA: 50,50,50,50,50,50 TD-SCDMA: 50 dBm, 50 dBm, 50 dBm, 50 dBm, 50 dBm, 50 dBm 50 dBm, 50 dBm, 50 dBm, 50 dBm, 50 dBm 1xEVDO: -27dBm, -27dBm, -13dBm, -13dBm, -13dBm, -13dBm -27dBm, -27dBm, -13dBm, -13dBm, -13dBm, -13dBm DVB-T/H: 50 dBm, 50 dBm, 50 dBm, 50 dBm, 50 dBm, 50 dBm 50 dBm, 50 dBm, 50 dBm, 50 dBm, 50 dBm DTMB: 11.14 dBm, 11.14dBm, 11.14 dBm, 11.14 dBm, 50 dBm, 50 dBm 50 dBm, 50 dBm, 50 dBm, 50 dBm, 50 dBm, 50 dBm
State Saved	Saved in instrument state.
Min	-200.0 dBm
Max	50.0 dBm
Instrument S/W Revision	Prior to A.02.00

Fail

Accesses a menu that enables you to select one of the logic keys for the fail conditions between the

measurement results and the test limits. The setting defines the type of testing to be done at any custom offset frequencies. The measured powers are tested against the absolute values defined with [:SENSe]:ACP:OFFSet[n]:LIST:ABSolute, or the relative values defined with [:SENSe]:ACP:OFFSet:LIST:RPSDensity and [:SENSe]:ACP:OFFSet:LIST:RCARrier.

You can turn off (not use) specific offsets with the [:SENS]:ACP:OFFSet:LIST:STATe command.

- Absolute – Fail is shown if one of the absolute ACP measurement results is larger than the limit for Abs Limit.
- Relative – Fail is shown if one of the relative ACP measurement results is larger than the limit for Rel Lim (Car) or Rel Lim (PSD).
- AND – Fail is shown if one of the absolute ACP measurement results is larger than the limit for Abs Limit AND one of the relative ACPR measurement results is larger than the limit for Rel Lim (Car) or Rel Lim (PSD).
- OR – Fail is shown if one of the absolute ACP measurement results is larger than the limit for Abs Limit OR one of the relative ACP measurement results is larger than the limit for Rel Lim (Car) or Rel Lim (PSD).

Remote Command	<pre>[:SENSe]:ACPower:OFFSet[1] 2:LIST:TEST ABSolute AND OR RELative, ABSolute AND OR RELative, ABSolute AND OR RELative, ABSolute AND OR RELative, ABSolute AND OR RELative, ABSolute AND OR RELative [:SENSe]:ACPower:OFFSet[1] 2:LIST:TEST?</pre>
Example	<pre>ACP:OFFS2:LIST:TEST ABS,ABS,ABS,ABS,ABS,ABS ACP:OFFS2:LIST:TEST?</pre>
Key Path	Meas Setup, Offset/Limit
Mode	SA, WCDMA, C2K, WIMAX OFDMA, TD-SCDMA, 1xEVDO, DVB-T/H, DTMB
Notes	<p>Offset sub op code. 1 for BTS, 2 for MS. Default is BTS.</p> <p>You must be in the mode that includes ACP measurements to use this command. Use :INSTrument:SELect to set the mode.</p>
Preset	<pre>SA, WCDMA, C2K, TD-SCDMA: REL, REL, REL, REL, REL, REL REL, REL, REL, REL, REL, REL WIMAX OFDMA: REL, REL, REL, REL, REL, REL DVB-T/H: REL, REL, REL, REL, REL, REL DTMB: OR,AND, AND,AND, REL, REL CDMA1xEVDO: REL, REL, ABS, REL, REL, REL REL, REL, ABS, REL, REL, REL</pre>
State Saved	Saved in instrument state.
Range	AND OR Absolute Relative
Instrument S/W Revision	Prior to A.02.00

Rel Lim (Car)

Enters a relative limit value for the carrier level. This sets the amplitude levels to test against for the specified offsets. The

amplitude level is relative to the carrier amplitude. If multiple offsets are available, the list contains six (6) entries. The offset closest to the carrier channel is the first one in the list.

`[:SENSe]:ACP:OFFSet:LIST:TEST` selects the type of testing to be done at each offset.

`[:SENSe]:ACP:OFFSet[n]:LIST[n]:TEST` selects the type of testing to be done at each offset.

You can turn off (not use) specific offsets with the `[:SENSe]:ACP:OFFSet[n]:LIST[n]:STATe` command.

The query returns the six (6) sets of real numbers that are the current amplitude test limits, relative to the carrier, for each offset.

Offset[n] n=1 is base station and 2 is mobiles. The default is base station (1).

Remote Command	<code>[:SENSe]:ACP:Power:OFFSet[1] 2:LIST:RCARrier <real>, <real>, <real>, <real>, <real></code> <code>[:SENSe]:ACP:Power:OFFSet[1] 2:LIST:RCARrier?</code>
Example	<code>ACP:OFFS2:LIST:RCAR 0,0,0,0,0</code> <code>ACP:OFFS2:LIST:RCAR?</code>
Dependencies/Couplings	None
Key Path	Meas Setup, Offset/Limit
Mode	SA, WCDMA, C2K, WIMAX OFDMA, TD-SCDMA, 1xEVDO, DVB-T/H, DTMB
Notes	<code>:CALCulate:ACP:Power:OFFSet[1] 2:LIST:LIMit:POSitive[:UPPer]:DATA</code> and <code>:CALCulate:ACP:Power:OFFSet[1] 2:LIST:LIMit:NEGative[:UPPer]:DATA</code> are expanded to support subop code. Offset sub op code. 1 for BTS, 2 for MS. Default is BTS. You must be in the mode that includes ACP measurements to use this command. Use <code>:INSTrument:SELect</code> to set the mode.
Preset	SA: <code>-45, -60, 0, 0, 0, 0 -45, -60, 0, 0, 0, 0</code> WCDMA: <code>-44.2, -49.2, -49.2, -49.2, -49.2, -49.2 -32.2, -42.2, -42.2, -42.2, -42.2, -42.2</code> C2K: <code>0, 0, 0, 0, 0, 0 0, 0, 0, 0, 0, 0</code> WIMAX OFDMA: <code>-50,-60,0,0,0,0</code> TD-SCDMA: <code>-40, -45, -45, -45, -45, -45 -33, -43, -43, -43, -43, -43</code> 1xEVDO: <code>-45, -55, -55, -55, -55, -55 -45, -55, -55, -55, -55, -55</code> DVB-T/H: <code>-60, -60, 0, 0, 0, 0 0, 0, 0, 0, 0, 0</code> DTMB: <code>-45, -60, -60, -60, 50, 50 0, 0, 0, 0, 0, 0</code>
State Saved	Saved in instrument state.

Min	-150
Max	50.0
Instrument S/W Revision	Prior to A.02.00

Rel Lim (PSD)

Enters a relative limit value for the level of the power spectral density. This sets the amplitude levels to test against for any custom offsets. The amplitude level is relative to the power spectral density. If multiple offsets are available, the list contains six (6) entries. The offset closest to the carrier channel is the first one in the list.

`[[:SENSE]:ACP:OFFSET[n]:LIST[n]:TEST` selects the type of testing to be done at each offset.

You can turn off (not use) specific offsets with the `[[:SENSE]:ACP:OFFSET[n]:LIST:STATE` command.

The query returns the six (6) sets of real numbers that are the current amplitude test limits, relative to the power spectral density, for each offset.

Offset[n] n=1 is base station and 2 is mobiles. The default is base station (1).

Remote Command

```
[[:SENSE]:ACPower:OFFSET[1]|2:LIST:RPSDdensity
<rel_ampl>, <rel_ampl>, <rel_ampl>, <rel_ampl>,
<rel_ampl>, <rel_ampl>
```

```
[[:SENSE]:ACPower:OFFSET[1]|2:LIST:RPSDdensity?
```

Example

```
ACP:OFFS2:LIST:RPSD 10,10,10,10,10,10
```

```
ACP:OFFS2:LIST:RPSD?
```

Key Path

Meas Setup, Offset/Limit

Mode

SA, WCDMA, C2K, WIMAX OFDMA, TD-SCDMA, 1xEVDO, DVB-T/H, DTMB

Notes

Offset sub op code. 1 for BTS, 2 for MS. Default is BTS.

You must be in the mode that includes ACP measurements to use this command. Use `:INSTRUMENT:SELECT` to set the mode.

ACP Measurement Meas Setup

Preset	SA: -28.87 dB, -43.87 dB, 0 dB, 0 dB, 0 dB, 0 dB -28.87 dB, -43.87 dB, 0 dB, 0 dB, 0 dB, 0 dB WCDMA: -44.2 dB, -49.2 dB, -49.2 dB, -49.2 dB, -49.2 dB, -49.2 dB -32.2 dB, -42.2 dB, -42.2 dB, -42.2 dB, -42.2 dB, -42.2 dB C2K: 0 dB, 0 dB, 0 dB, 0 dB, 0 dB, 0 dB 0 dB, 0 dB, 0 dB, 0 dB, 0 dB, 0 dB WIMAX OFDMA: -25,-35,0,0,0,0 TD-SCDMA: -40 dB, -45 dB, -45 dB, -45 dB, -45 dB, -45 dB -33 dB, -43 dB, -43 dB, -43 dB, -43 dB, -43 dB 1xEVDO: -45, -55, -55, -55, -55, -55 -45, -55, -55, -55, -55, -55 DVB-T/H: -60dB, -60dB, 0 dB, 0 dB, 0 dB, 0 dB 0dB, 0dB, 0 dB, 0 dB, 0 dB, 0 dB DTMB: 50dB, 50dB, 50dB, 50dB, 50dB, 50dB 0dB, 0dB, 0 dB, 0 dB, 0 dB, 0 dB
State Saved	Saved in instrument state.
Min	-150.0 dB
Max	50.0 dB
Instrument S/W Revision	Prior to A.02.00

Carrier Result

Allows you to view and scroll through the carrier power results.

Dependencies/Couplings	This key will be grayed out if there is only one carrier.
Key Path	Meas Setup
Mode	SA, WCDMA, C2K, WIMAX OFDMA, TD-SCDMA. 1xEVDO, DVB-T/H, DTMB
Preset	1
State Saved	No
Min	1
Max	Number of carriers.
Instrument S/W Revision	Prior to A.02.00

PhNoise Opt

Selects the LO (local oscillator) phase noise behavior for various operating conditions.

Key Path	Meas Setup
Instrument S/W Revision	Prior to A.02.00

PhNoise Opt Auto

Selects the LO (local oscillator) phase noise behavior for various operating conditions.

Auto will choose:

Fast Tuning whenever Span > 12.34 MHz or RBW > 250 kHz,

otherwise, if center frequency is < 25 kHz OR ALL of the following are true:

CF >= 1 MHz AND Span <= 141.4 kHz AND RBW <= 5 kHz

then **Best Phase Noise at Offset < 20 kHz;**

otherwise, **Best Phase Noise at Offset > 30 kHz.**

Remote Command	[:SENSe] :ACPower :FREQuency :SYNThesis :AUTO [:STATe] OFF ON 0 1 [:SENSe] :ACPower :FREQuency :SYNThesis :AUTO [:STATe] ?
Example	ACP:FREQ:SYNT:AUTO 1 ACP:FREQ:SYNT:AUTO?
Key Path	Meas Setup
Mode	SA, WCDMA, C2K, WIMAX OFDMA, TD-SCDMA, 1xEVDO, DVB-T/H, DTMB
Preset	ON
State Saved	Saved in instrument state.
Range	Auto Man
Readback Text	The “Auto” is underlined when Auto is selected, otherwise the Man is underlined.
Instrument S/W Revision	Prior to A.02.00

PhNoise Opt State

Selects the LO (local oscillator) phase noise behavior for various operating conditions.

Remote Command	[:SENSe] :ACPower :FREQuency :SYNThesis [:STATe] 1 2 3 [:SENSe] :ACPower :FREQuency :SYNThesis [:STATe] ?
Example	ACP:FREQ:SYNT 1 ACP:FREQ:SYNT?
Key Path	Meas Setup
Mode	SA, WCDMA, C2K, WIMAX OFDMA, TD-SCDMA, 1xEVDO, DVB-T/H, DTMB

ACP Measurement Meas Setup

Notes	Parameter key: 1 - optimizes phase noise for frequencies offset <20 kHz from the carrier. 2 - optimizes phase noise for frequencies offset >30 kHz from the carrier. 3 - optimizes LO for tuning speed.
Preset	Because this function is in Auto after preset, the state of this function after Preset will be automatically calculated.
State Saved	Saved in instrument state.
Range	BestPhase Noise at offset < 20 kHz BestPhase Noise at offset > 30 kHz Fast Tuning
Readback Text	f < 20 kHz f > 30 kHz Fast Tuning, also the Man must be underlined.
Instrument S/W Revision	Prior to A.02.00

Meas Method

Sets the desired method to measure ACP.

Integration BW — one sweep of the trace is taken, and the band power for each offset is computed. Depending on the status of the Meas Type parameter (Total Power Reference or PSD Reference), results are displayed relative to the total power or the power spectral density. The display reflects either the current trace or a bar graph view.

Filtered IBW (max dynamic range) — ACP Path is used to compute ACP when an ACP path is available. This method increases dynamic range, but increases measurement time as it limits the resolution bandwidth. This method is useful for improving dynamic range on W-CDMA signal because of a sharp cutoff band pass filter is used. The accuracy of the adjacent channel power ratio is not degraded by this method, but the absolute accuracy of both adjacent channel power and carrier power are degraded by up to about 0.5 dB.

RBW — the algorithm uses zero-span and an appropriate RBW setting to capture all of the power in the carrier channel and the offsets. The zero-span algorithm (RBW method) is slower than the IBW method, but greatly improves repeatability.

Fast (in WCDMA mode or SA mode with 3GPP WCDMA radio standard selected) — this provides the same method as the Integration BW method, but with optimized for speed to measure W-CDMA signal.

Fast (in CDMA2K mode or SA mode with CDMA2K radio standard selected) – This provides faster measurement using FFT method with the limited parameter flexibility. When this is selected, CDMA2K preset offsets are given and control of follows are grayed out.

BW menu, Sweep/Control menu except Pause/Resume, Trace/Detector menu, Carrier Setup, Offset Limit, RRC Weighting, Filter Alpha and Noise Correction softkeys in MeasSetup menu

In the TD-SCDMA mode, only the Integration BW method is available. Therefore, the Meas Method key is not displayed in the TD-SCDMA mode.

Remote Command	[:SENSe] :ACPower:METhod IBW IBWRange FAST RBW [:SENSe] :ACPower:METhod?
-----------------------	---

Example	ACP:METH IBW ACP:METH?
Dependencies/Couplings	IBW (Range) restricts the Res BW available for making this measurement to 30kHz. When selected the Res Bw will be clipped to this value if required and an error number displayed.
Key Path	Meas Setup
Mode	SA, WCDMA, C2K, WIMAX OFDMA, 1xEVDO, DVB-T/H, DTMB
Notes	In the TDSCDMA mode, only the IBW method is available to use. Therefore, the measure method key is not displayed in the TD-SCDMA mode. CDMA1xEVDO mode only supports RBW and Integration BW method. C2K mode only supports RBW, Integration BW and FAST method. FAST mode is only supported for WCDMA and C2K signal. You must be in the WCDMA or C2K mode or SA mode with 3GPP WCDMA or CDMA2K radio standard. Otherwise a setting conflict error message will be reported. Supporting FAST mode in C2K is available with the instrument version A.02.00 or later You must be in the mode that includes ACP measurements to use this command. Use :INSTrument:SElect to set the mode.
Preset	SA: IBW WCDMA: IBW C2K: RBW WIMAX OFDMA: IBW 1xEVDO: IBW DVB-T/H: IBW DTMB: IBW
State Saved	Saved in instrument state.
Range	Integration BW Filtered IBW (max dynamic range) RBW Fast
Readback Text	IBW Filtered IBW RBW Fast
Instrument S/W Revision	Prior to A.02.00
Modified at S/W Revision	A.02.00

Meas Type

Changes the reference used for the measurement. This allows you to make absolute and relative power measurements of either total power or the power normalized to the measurement bandwidth.

Total Pwr Ref (TPR) sets the reference to the total carrier power. PSD Ref (PSDR) sets the reference to

ACP Measurement Meas Setup

the power spectral density of the carrier.

Remote Command	<code>[:SENSe] :ACPower :TYPE TPreF PSDRef</code> <code>[:SENSe] :ACPower :TYPE?</code>
Example	ACP:TYPE PSDR ACP:TYPE?
Key Path	Meas Setup
Mode	SA, WCDMA, C2K, WIMAX OFDMA, TD-SCDMA, 1xEVDO, DVB-T/H, DTMB
Notes	You must be in the mode that includes ACP measurements to use this command. Use :INSTrument:SElect to set the mode.
Preset	TPreF
State Saved	Saved in instrument state.
Range	Total Power Ref PSD Ref
Instrument S/W Revision	Prior to A.02.00

PSD Ref

Sets the unit bandwidth for Power Spectral Density. The available units are dBm/Hz and dBm/MHz.

Remote Command	<code>:UNIT :ACPower :POWER :PSD DBMHZ DBMMHZ</code> <code>:UNIT :ACPower :POWER :PSD?</code>
Example	UNIT:ACP:POW:PSD DBMMHZ UNIT:ACP:POW:PSD?
Dependencies/Couplings	When the PSD unit is changed, the PSD reference result of the “MEAS READ FETCh:ACP[n]?” is also changed by the PSD unit basis (in either dBm/Hz or dBm/MHz).
Key Path	Meas Setup
Mode	A, WCDMA, C2K, WIMAX OFDMA, TD-SCDMA, 1xEVDO, DVB-T/H, DTMB
Preset	DBMHZ
State Saved	Saved in instrument state.
Range	dBm/Hz dBm/MHz
Instrument S/W Revision	Prior to A.02.00

Limit Test

Turns limit checking for each offset On or Off. The limits may be specified within the Offset menu, for each offset, both sides of the carrier. For results that fail the limit, a red F is appended. In Combined

view, the bar turns red.

Remote Command	<code>:CALCulate:ACPower:LIMit:STATe OFF ON 0 1</code> <code>:CALCulate:ACPower:LIMit:STATe?</code>
Example	<code>CALC:ACP:LIM OFF</code> <code>CALC:ACP:LIM?</code>
Key Path	Meas Setup
Mode	SA, WCDMA, C2K, WIMAX OFDMA, TD-SCDMA, 1xEVDO, DVB-T/H, DTMB
Notes	You must be in the mode that includes ACP measurements to use this command. Use <code>:INSTrument:SElect</code> to set the mode.
Preset	SA: OFF WCDMA: ON C2K: ON WIMAX OFDMA: OFF TD-SCDMA: ON 1xEVDO: ON DVB-T/H: OFF DTMB: ON
State Saved	Saved in instrument state.
Range	On Off
Instrument S/W Revision	Prior to A.02.00

Offset RRC Weighting

Allows you to turn RRC filtering of the carriers and all adjacent channels on or off. The α value (roll off) for the filter will be set to the value of the Filter Alpha parameter.

Remote Command	<code>[:SENSE] :ACPower :FILTer [:RRC] [:STATe] OFF ON 0 1</code> <code>[:SENSE] :ACPower :FILTer [:RRC] [:STATe] ?</code>
Example	<code>ACP:FILT OFF</code> <code>ACP:FILT?</code>
Key Path	Meas Setup
Mode	SA, WCDMA, TD-SCDMA, DVB-T/H, DTMB
Notes	This parameter is not available for cdma2000 You must be in the mode that includes ACP measurements to use this command. Use <code>:INSTrument:SElect</code> to set the mode.

ACP Measurement Meas Setup

Preset	SA: OFF WCDMA: ON C2K: NO WIMAX OFDMA: OFF TD-SCDMA: ON DVB-T/H: OFF DTMB:ON
State Saved	Saved in instrument state.
Range	On Off
Instrument S/W Revision	Prior to A.02.00

Offset Filter Alpha

Sets the alpha value for the RRC Filter.

Remote Command	<code>[:SENSE] :ACPower :FILTER [:RRC] :ALPHA <real></code> <code>[:SENSE] :ACPower :FILTER [:RRC] :ALPHA?</code>
Example	ACP:FILT:ALPH 0.5 ACP:FILT:ALPH?
Key Path	Meas Setup
Mode	SA, WCDMA, TD-SCDMA, DVB-T/H, DTMB
Notes	This parameter is not available for cdma2000 You must be in the mode that includes ACP measurements to use this command. Use :INSTrument:SElect to set the mode.
Preset	SA: 0.22 WCDMA: 0.22 WIMAX OFDMA: 0.22 C2K: NO TD-SCDMA: 0.22 DVB-T/H: 0.22 DTMB: 0.05
State Saved	Saved in instrument state.
Min	0.01
Max	1.00
Instrument S/W Revision	Prior to A.02.00

Meas Preset

Restores all the measurement parameters to their default values.

Remote Command	:CONFigure:ACPover
Example	CONF:ACP
Dependencies/Couplings	Selecting Meas Preset will restore all measurement parameters to their default values.
Key Path	Meas Setup
Mode	SA, WCDMA, C2K, WIMAX OFDMA, TD-SCDMA, 1xEVDO, DVB-T/H, DTMB
Notes	You must be in the mode that includes ACP measurements to use this command. Use :INSTrument:SElect to set the mode.
Instrument S/W Revision	Prior to A.02.00

Noise Correction

Sets the noise floor correction function to On or Off. On enables measurement noise correction when the measured power in the reference channel or any offset is close to the noise floor of the analyzer. Off turns these corrections off.

Remote Command	[:SENSE]:ACPover:CORRection:NOISe[:AUTO] OFF ON 0 1 [:SENSE]:ACPover:CORRection:NOISe[:AUTO]?
Example	ACP:CORR:NOIS OFF ACP:CORR:NOIS?
Key Path	Meas Setup
Mode	SA, WCDMA, C2K, WIMAX OFDMA, TD-SCDMA, 1xEVDO, DVB-T/H, DTMB
Notes	You must be in the mode that includes ACP measurements to use this command. Use :INSTrument:SElect to set the mode.
Preset	0
State Saved	Saved in instrument state.
Range	On Off
Instrument S/W Revision	Prior to A.02.00

Mode

See “[Mode](#)” on page 1145 in the section "Common Measurement Functions" for more information.

Mode Setup

See “[Mode Setup](#)” on page 1159 in the section "Common Measurement Functions" for more information.

Peak Search

Accesses a menu that enables you to control the peak search function.

Key Path	Front-panel key
Instrument S/W Revision	Prior to A.02.00

Peak Search

Places the selected marker on the trace point with the maximum y-axis value.

Remote Command	:CALCulate:ACPower:MARKer[1] 2 3 4 5 6 7 8 9 10 11 12:MAXimum
Example	CALC:ACP:MARK2:MAX
Key Path	Peak Search
Mode	SA, WCDMA, C2K, WIMAX OFDMA, TD-SCDMA, 1xEVDO, DVB-T/H, DTMB
Instrument S/W Revision	Prior to A.02.00

Next Peak

Moves the selected marker to the peak that has the next highest amplitude.

Remote Command	:CALCulate:ACPower:MARKer[1] 2 3 4 5 6 7 8 9 10 11 12:MAXimum:NEXT
Example	CALC:ACP:MARK2:MAX:NEXT
Key Path	Peak Search
Mode	SA, WCDMA, C2K, WIMAX OFDMA, TD-SCDMA, 1xEVDO, DVB-T/H, DTMB
Instrument S/W Revision	Prior to A.02.00

Next Pk Right

Moves the selected marker to the nearest peak to the right of the current marker that meets all enabled peak criteria.

Remote Command	:CALCulate:ACPower:MARKer[1] 2 3 4 5 6 7 8 9 10 11 12:MAXimum:RIGHT
Example	CALC:ACP:MARK2:MAX:RIGH
Key Path	Peak Search

Mode	SA, WCDMA, C2K, WIMAX OFDMA, TD-SCDMA, 1xEVDO, DVB-T/H, DTMB
Instrument S/W Revision	Prior to A.02.00

Next Pk Left

Moves the selected marker to the nearest peak to the left of the current marker that meets all enabled peak criteria.

Remote Command	:CALCulate:ACPower:MARKer[1] 2 3 4 5 6 7 8 9 10 11 12:MAXimum:LEFT
Example	CALC:ACP:MARK2:MAX:LEFT
Key Path	Peak Search
Mode	SA, WCDMA, C2K, WIMAX OFDMA, TD-SCDMA, 1xEVDO, DVB-T/H, DTMB
Instrument S/W Revision	Prior to A.02.00

Marker Delta

Sets the control mode for the selected marker to Delta mode.

See Marker Delta in the "Marker Functions" section for more information.

Key Path	Peak Search
Instrument S/W Revision	Prior to A.02.00

Pk-Pk Search

Finds and displays the amplitude and frequency (or time, if in zero span) differences between the highest and lowest y-axis value.

Remote Command	:CALCulate:ACPower:MARKer[1] 2 3 4 5 6 7 8 9 10 11 12:PTPeak
Example	CALC:ACP:MARK:PTP
Dependencies/Couplings	This key is not available (key is grayed out) when Coupled Markers is on.
Key Path	Peak Search
Mode	SA, WCDMA, C2K, WIMAX OFDMA, TD-SCDMA, 1xEVDO, DVB-T/H, DTMB
Notes	Turns on the Marker Δ active function.
Instrument S/W Revision	Prior to A.02.00

Min Search

Moves the selected marker to the minimum y-axis value on the current trace.

Remote Command	:CALCulate:ACPower:MARKer[1] 2 3 4 5 6 7 8 9 10 11 12:MINimum
Example	CALC:ACP:MARK:MIN
Key Path	Peak Search
Mode	SA, WCDMA, C2K, WIMAX OFDMA, TD-SCDMA, 1xEVDO, DVB-T/H, DTMB
Instrument S/W Revision	Prior to A.02.00

Recall

See [“Recall” on page 1179](#) in the section "Common Measurement Functions" for more information.

Restart

See “[Restart](#)” on page 1201 in the section "Common Measurement Functions" for more information.

Save

See [“Save” on page 1203](#) in the section "Common Measurement Functions" for more information.

Single

See “[Single \(Single Measurement/Sweep\)](#)” on page 1229 in the section "Common Measurement Functions" for more information.

Source

See “[Source](#)” on page 1231 in the section "Common Measurement Functions" for more information.

SPAN X Scale

Accesses a menu of functions that enable you set the horizontal scale parameters.

Key Path	Front-panel key
Instrument S/W Revision	Prior to A.02.00

Span

Changes the frequency range symmetrically about the center frequency.

The default (and minimum) span is calculated using the number of carriers and the carrier width where;

$$\text{Span} = (\text{Upper Carrier Freq} + (\text{max offset IBW} * (1 + \alpha)) / 2) - (\text{Lower Carrier Freq} - (\text{max offset IBW} * (1 + \alpha)) / 2)$$

The span is increased by a factor of 1 + Filter Alpha if the RRC Filter is on.

Remote Command	<code>[:SENSe] :ACPpower:FREQuency:SPAN <freq></code> <code>[:SENSe] :ACPpower:FREQuency:SPAN?</code>
Example	ACP:FREQ:SPAN 25MHz ACP:FREQ:SPAN?
Dependencies/Couplings	The span value is clipped when the carrier settings and/or the offset settings are changed. The value is changed to satisfy following formula: $\text{Span} = (\text{Upper Carrier Freq} + (\text{max offset IBW} * (1 + \alpha)) / 2) - (\text{Lower Carrier Freq} - (\text{max offset IBW} * (1 + \alpha)) / 2)$
Key Path	Span X Scale
Mode	SA, WCDMA, C2K, WIMAX OFDMA, TD-SCDMA, 1xEVDO, DVB-T/H, DTMB
Notes	You must be in the mode that includes ACP measurements to use this command. Use :INSTrument:SElect to set the mode.
Preset	SA: 8 MHz WCDMA: 24.6848 MHz WIMAX OFDMA: 50MHz C2K: 4.5 MHz TD-SCDMA: 8MHz 1xEVDO: 4.05 MHz DVB-T/H: 40MHz DTMB: 72MHz
State Saved	Saved in instrument state.

Min	10 Hz
Max	Hardware Dependent: Option 503 = 3.7 GHz Option 507 = 7.1 GHz Option 508 = 8.5 GHz Option 513 = 13.8 GHz Option 526 = 27.0 GHz
Instrument S/W Revision	Prior to A.02.00

Full Span

Changes the span to show the full frequency range of the spectrum analyzer.

Remote Command	[:SENSE] :ACPpower :FREQuency :SPAN :FULL
Example	ACP:FREQ:SPAN:FULL
Key Path	Span X Scale
Mode	SA, WCDMA, C2K, WiMAX OFDMA, TD-SCDMA, 1xEVDO, DVB-T/H, DTMB
Notes	You must be in the mode that includes ACP measurements to use this command. Use :INSTrument:SElect to set the mode.
Instrument S/W Revision	Prior to A.02.00

Last Span

Changes the span to the previous span setting. If no previous span value exists, then the span will remain unchanged.

Remote Command	[:SENSE] :ACPpower :FREQuency :SPAN :PREVIOUS
Example	ACP:FREQ:SPAN:PREV
Key Path	Span X Scale
Mode	SA, WCDMA, C2K, WIMAX OFDMA, TD-SCDMA, 1xEVDO, DVB-T/H, DTMB
Notes	You must be in the mode that includes ACP measurements to use this command. Use :INSTrument:SElect to set the mode.
Instrument S/W Revision	Prior to A.02.00

Sweep/Control

Accesses a menu of functions that enable you to set up and control the sweep time, and source.

See “Sweep / Control” on page 1235 in the "Common Measurement Functions" section for more information.

Key Path	Front-panel key
Instrument S/W Revision	Prior to A.02.00

Sweep Time

Selects the length of time in which the spectrum analyzer sweeps the displayed frequency span. In swept spans, the sweep time varies from 1 millisecond to 2000 seconds. Additional overhead time, which impacts the sweep rate, is not calculated as part of the sweep time. In fact:

sweep rate = span/sweep time

update rate = 1/(sweep time + overhead)

sweep cycle time = sweep time + overhead

Sweep time is coupled to RBW and VBW, and is impacted by the number of sweep points, so changing those parameters may change the sweep time.

If you increase the sweep time, you increase the length of the time data captured and the number of points measured. You might need to specify a specific sweep speed to accommodate a specific condition in your transmitter. For example, you may have a burst signal and need to measure an exact portion of the burst.

Selecting a specific sweep time may result in a long measurement time since the resulting number of data points may not be the optimum 2n. Use [:SENSe]:ACP:OFFSet:LIST:SWEep:TIME to set the number of points used for measuring the offset channels for Basic and cdmaOne.

For cdma2000 and W-CDMA, this command sets the sweep time when using the sweep mode. See [:SENSe]:ACP:SWEep:TYPE

Remote Command	[:SENSe]:ACP:Power:SWEep:TIME <time>
	[:SENSe]:ACP:Power:SWEep:TIME?
	[:SENSe]:ACP:Power:SWEep:TIME:AUTO OFF ON 0 1
	[:SENSe]:ACP:Power:SWEep:TIME:AUTO?

Example	ACP:SWE:TIME 50ms
	ACP:SWE:TIME?
	ACP:SWE:TIME:AUTO OFF
	ACP:SWE:TIME:AUTO?

Dependencies/Couplings	When you manually change the Sweep Time, this state automatically goes to 'Man'.
Key Path	Sweep/Control
Mode	SA, WCDMA, C2K, WIMAX OFDMA, TD-SCDMA, 1xEVDO, DVB-T/H, DTMB
Notes	This parameter is preset by Meas Method selection. Preset values are as follows: IBW: 29 ms IBWR: 108 ms FAST (WCDMA): 7.5 ms
Preset	SA: Automatically calculated WCDMA: 29 ms WIMAX OFDMA: Automatically calculated C2K: Automatically calculated TD-SCDMA: Automatically calculated 1xEVDO: Automatically calculated DVB-T/H: Automatically calculated DTMB: Automatically calculated SA: ON WCDMA: OFF C2K: OFF(mehtod IBW) WIMAX OFDMA: ON TD-SCDMA: ON DVB-T/H: ON DTMB: ON
State Saved	Saved in instrument state.
Min	1 ms
Max	4000 s
Instrument S/W Revision	Prior to A.02.00

Sweep Setup

Accesses the sweep setup menu.

Key Path	Sweep/Control
Instrument S/W Revision	Prior to A.02.00

Auto Sweep Time Rules

Switches the analyzer between normal and accuracy sweep states.

Remote Command	[:SENSe] :ACPpower :SWEep :TIME :AUTO :RULes NORMal ACCuracy [:SENSe] :ACPpower :SWEep :TIME :AUTO :RULes?
Example	ACP:SWE:TIME:AUTO:RUL NORM ACP:SWE:TIME:AUTO:RUL?
Key Path	Sweep/Control, Sweep Setup
Mode	SA, WCDMA, C2K, WIMAX OFDMA, TD-SCDMA, 1xEVDO, DVB-T/H, DTMB
Notes	Set to Norm when Auto Couple is pressed or sent remotely.
Preset	SA, WCDMA, C2K, TD-SCDMA, 1xEVDO, DVB-T/H, DTMB: ACCuracy WIMAX OFDMA: NORMal
State Saved	Saved in instrument state.
Range	Norm Accy
Instrument S/W Revision	Prior to A.02.00

Pause

Pauses a measurement after the current data acquisition is complete. When Paused, the label on the key changes to Resume. Pressing the Resume key resumes the measurement at the point it was at when paused. See [“Pause/Resume” on page 1236](#) in “Common Measurement Functions” for more details.

Key Path	Sweep/Control
Instrument S/W Revision	Prior to A.02.00

Gate

Accesses a menu that enables you to control the gating function .The Gate functionality is used to view signals best viewed by qualifying them with other events.

Gate Method that lets you choose one of the three different types of gating is not available in this measurement.

See [“Gate ” on page 1236](#) in “common Measurement Functions” for more details.

Key Path	Sweep/Control
Instrument S/W Revision	Prior to A.02.00

Points

Sets the number of points per sweep, from 1 to 20001. The sweep time resolution setting will depend on the number of points selected.

Remote Command	[:SENSe] :ACPower :SWEep :POINTs <integer> [:SENSe] :ACPower :SWEep :POINTs?
Example	ACP:SWE:POIN 500 ACP:SWE:POIN?
Dependencies/Couplings	Whenever the number of sweep points changes, the sweep time is re-quantized.
Key Path	Sweep/Control
Mode	SA, WCDMA, C2K, WIMAX OFDMA, TD-SCDMA, 1xEVDO, DVB-T/H, DTMB
Notes	Whenever the number of sweep points changes: <ul style="list-style-type: none"> • All trace data is erased • Any traces with Update Off will also go to Display Off (like going from View to Blank in the older analyzers) • Sweep time is re-quantized • Any limit lines that are on will be updated • If averaging/hold is on, averaging/hold starts over
Preset	1001 DVB-T/H:2001 DTMB: 2001
State Saved	Saved in instrument state.
Min	1
Max	20001
Instrument S/W Revision	Prior to A.02.00

Trace/Detector

Accesses a menu of functions that enable you to control the detectors for the current measurement.

Key Path	Front-panel key
Instrument S/W Revision	Prior to A.02.00

Trace Type

Allows you to select the type of trace for the current measurement. The first page of this menu contains a selection of the trace type (Clear Write, Trace Average, Max Hold, Min Hold) for the selected trace.

Remote Command	<pre>:TRACe:ACPower[:TRACe1 2 3]:TYPE WRITE AVERage MAXHold MINHold :TRACe[1] 2 3:ACPower:TYPE WRITE AVERage MAXHold MINHold :TRACe:ACPower[:TRACe1 2 3]:TYPE? :TRACe[1] 2 3:ACPower:TYPE?</pre>
Example	<pre>TRAC:ACP:TYPE MINH TRAC:ACP:TYPE?</pre>
Dependencies/Couplings	When Detector setting is “Auto” ([:SENSe]:ACPower:DETECTOR:AUTO?), Detector is set to what the Radio Standard defaults states (see detector section below) for all conditions of Trace Type and for all traces. When set to Manual, all Traces use the same detector type. When Average State = Off then Trace Types AVERage, MaxHold and MinHold will not function, since Averaging is required to be ‘on’ for them to operate.
Key Path	Trace/Detector
Mode	SA, WCDMA, C2K, WIMAX OFDMA, TD-SCDMA, 1xEVDO, DVB-T/H, DTMB
Notes	<p>WRITE = Clear Write</p> <p>AVERage = Average</p> <p>MAXHold = Maximum Hold</p> <p>MINHold = Minimum Hold</p>
Preset	AVERage
State Saved	Saved in instrument state.
Range	WRITE AVERage MAXHold MINHold
Instrument S/W Revision	Prior to A.02.00

Detector

Accesses a menu of functions that enables you to control the detectors for the current measurement. The following choices are available:

- Auto- the detector selected is set to AVERage, unless the Radio Standard defaults state otherwise e.g. it is set to Peak for Radio Standard = PDC when Device = both MS and BTS, and when Radio Standard = NADC and Device = MS .
- Normal-the detector determines the peak of the CW-like signals, and it yields alternating maximums and minimums of noise-like signals. This is also referred to as Rosenfell detection.
- Average-the detector determines the average of the signal within the sweep points. The averaging method is Power (RMS).).
- Peak-the detector determines the maximum of the signal within the sweep points.
- Sample-the detector indicates the instantaneous level of the signal at the center of the sweep points represented by each display point.
- Negative Peak-the detector determines the minimum of the signal within the sweep points.

In swept analysis, the time interval of the data collection for the display sweep points also represents a frequency interval. In FFT analysis, the sweep points represents just a frequency interval. The detector determines the relationship between the spectrum computed by the FFT and the single data point displayed for the sweep points.

Key Path	Detector
Instrument S/W Revision	Prior to A.02.00

Detector Selection

Selects a detector to be used by the analyzer for the current measurement. All traces will use the same detector type, similar to Monitor Spectrum measurement

Remote Command	[:SENSE]:ACPpower:DETECTOR[:FUNCTION] AVERage NEGative NORMal POSitive SAMPle [:SENSE]:ACPpower:DETECTOR[:FUNCTION]?
Example	ACP:DET NORM ACP:DET?
Dependencies/Couplings	When Detector setting is “Auto” (:SENSE]:ACPpower:DETECTOR:AUTO?), Detector is set to what the Radio Standard defaults states (see detector section) for all conditions of Trace Type and for all traces. When set to Manual, all Traces use the same detector type. When Average State = Off then Trace Types AVERage, MaxHold and MinHold will not function, since Averaging is required to be ‘on’ for them to operate. Only one detector type for all 3 traces is allowed.
Key Path	Trace/Detector

ACP Measurement Trace/Detector

Mode	SA, WCDMA, C2K, WIMAX OFDMA, TD-SCDMA, 1xEVDO, DVB-T/H, DTMB
Notes	<p>When you manually select a detector (instead of selecting Auto), that detector is used regardless of other analyzer settings.</p> <p>The detector choices are:</p> <ul style="list-style-type: none">• The Normal detector determines the peak of CW-like signals, and it yields alternating maximums and minimums of noise-like signals. This is also referred to as Rosenfell detection.• The Average detector determines the average of the signal within the data range. The averaging method method is Power (RMS).• The Peak detector determines the maximum of the signal within the data range.• The Sample detector indicates the instantaneous level of the signal at the center of the data represented by each display point.• The Negative Peak detector determines the minimum of the signal within the data range. <p>Because they may not find a spectral component's true peak, neither average nor sample detectors measure amplitudes of CW signals as accurately as peak or normal, but they do measure noise without the biases of peak detection.</p> <p>When a detector selection is made, the menu returns to the previous menu.</p>
Preset	AVERAge
State Saved	Saved in instrument state.
Range	Normal Average Peak Sample Negative Peak
Instrument S/W Revision	Prior to A.02.00

Auto

Sets the detector for the currently selected trace to auto.

Remote Command	<pre>[:SENSe] :ACPower :DETECTOR :AUTO ON OFF 1 0 [:SENSe] :ACPower :DETECTOR :AUTO?</pre>
Example	<pre>ACP:DET:AUTO 1 ACP:DET?</pre>
Dependencies/Couplings	<p>When Detector setting is “Auto” ([:SENSe] :ACPower :DETECTOR :AUTO?), Detector is set to what the Radio Standard defaults states (see detector section) for all conditions of Trace Type and for all traces. When set to Manual, all Traces use the same detector type. When Average State = Off then Trace Types AVERAge, MaxHold and MinHold will not function, since Averaging is required to be ‘on’ for them to operate.</p>
Key Path	Trace/Detector

Mode	SA, WCDMA, C2K, WIMAX OFDMA, TD-SCDMA, 1xEVDO, DVB-T/H, DTMB
Preset	ON
State Saved	Saved in instrument state.
Range	ON OFF
Instrument S/W Revision	Prior to A.02.00

Select Trace (frontpanel only)

This key selects which trace the other parameters under the Trace/Detector menu will apply to.

Key Path	Trace/Detector
Mode	NF
Notes	No SCPI. Front panel only.
Preset	1
State Saved	Saved in instrument state.
Range	1 2 3
Instrument S/W Revision	Prior to A.02.00

View / Blank

Dependencies/Couplings

The four states of this 1-of-N actually set two variables, Update and Display, to their four possible combinations (only 2 will be implemented):

Trace On: Update and Display both On

View: Update Off and Display On (Not implemented)

Blank: Update Off and Display Off

Background: Update On, Display Off (Not implemented)

See tables below for detail on the SCPI to control these two variables.

Selecting a trace type (Clear Write, Trace Average, Max Hold, Min Hold) for a trace (pressing the key or sending the equivalent SCPI command) puts the trace in 'Trace On' state (**Update On and Display On**), even if that trace type was already selected.

Key Path	Trace/Detector
Mode	SA
Notes	No SCPI. Front panel only.
Preset	Trace On
State Saved	Saved in instrument state.

ACP Measurement Trace/Detector

Range	Trace On Blank
Instrument S/W Revision	Prior to A.02.00
Remote Command	:TRACe[1] 2 3:ACPower:UPDate[:STATE] ON OFF 0 1 :TRACe[1] 2 3:ACPower:UPDate[:STATE]?
Example	TRAC:ACP:UPD ON TRAC:ACP:UPD?
Dependencies/Couplings	Whenever you set Update to On for any trace, the Display is set to On for that trace.
Key Path	Trace/Detector
Preset	1 0 0 (On for Trace 1; Off for 2 &3)
State Saved	Saved in instrument state.
Range	0 1
Instrument S/W Revision	Prior to A.02.00
Remote Command	:TRACe[1] 2 3:ACPower:DISPlay[:STATE] ON OFF 0 1 :TRACe[1] 2 3:ACPower:DISPlay[:STATE]?
Example	TRAC:ACP:DISP ON TRAC:ACP:DISP?
Dependencies/Couplings	Whenever you set Update to On for any trace, the Display is set to On for that trace.
Key Path	Trace/Detector
Preset	1 0 0 (On for Trace 1; Off for 2 &3)
State Saved	Saved in instrument state.
Range	0 1
Instrument S/W Revision	Prior to A.02.00

Trigger

Accesses a menu functions that enable you to select and control the trigger source for the current measurement. See [“Trigger” on page 1253](#) in the "Common Measurement Functions" section for more information.

Key Path	Front-panel key
Instrument S/W Revision	Prior to A.02.00

View/Display

Accesses a menu of functions that enable you to control the instrument display as well as turn the bar graph On and Off.

The view consists of the following two windows:

“Spectrum Window” on page 432

“Results Window” on page 432

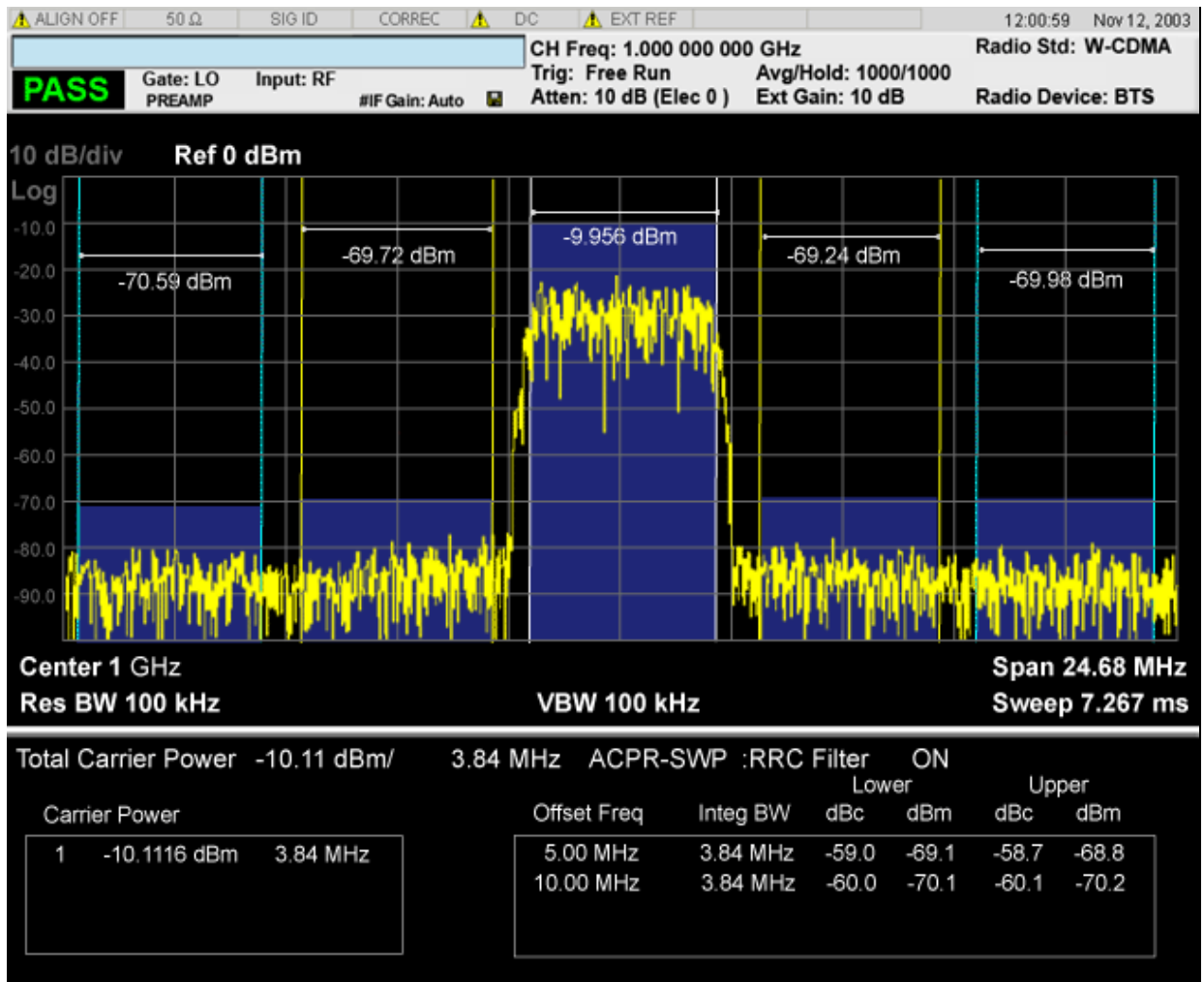

This is for DTMB transmitter and DTMB exciter:

DTMB Transmitter:

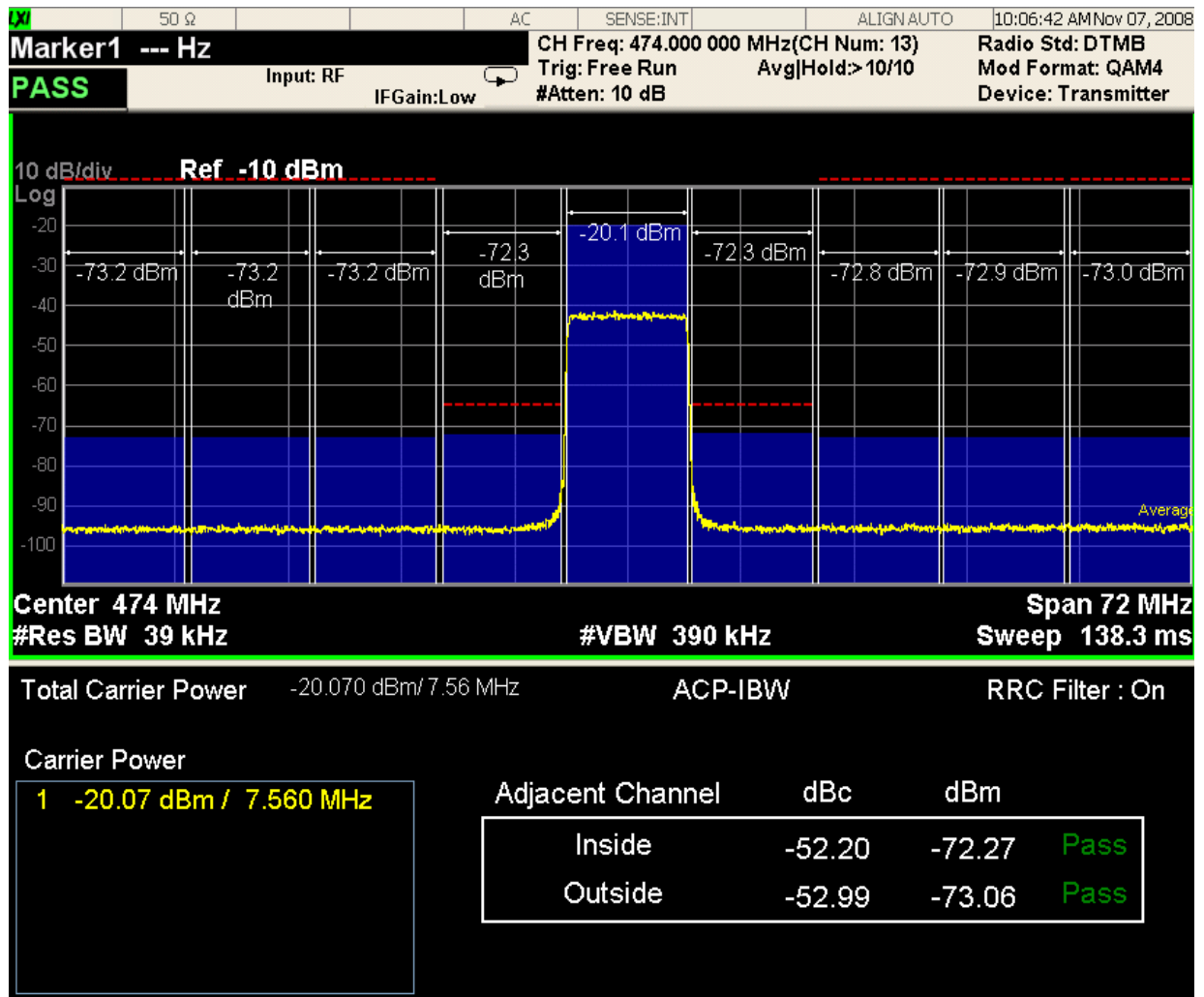

ACP Measurement
View/Display

DTMB Exciter:

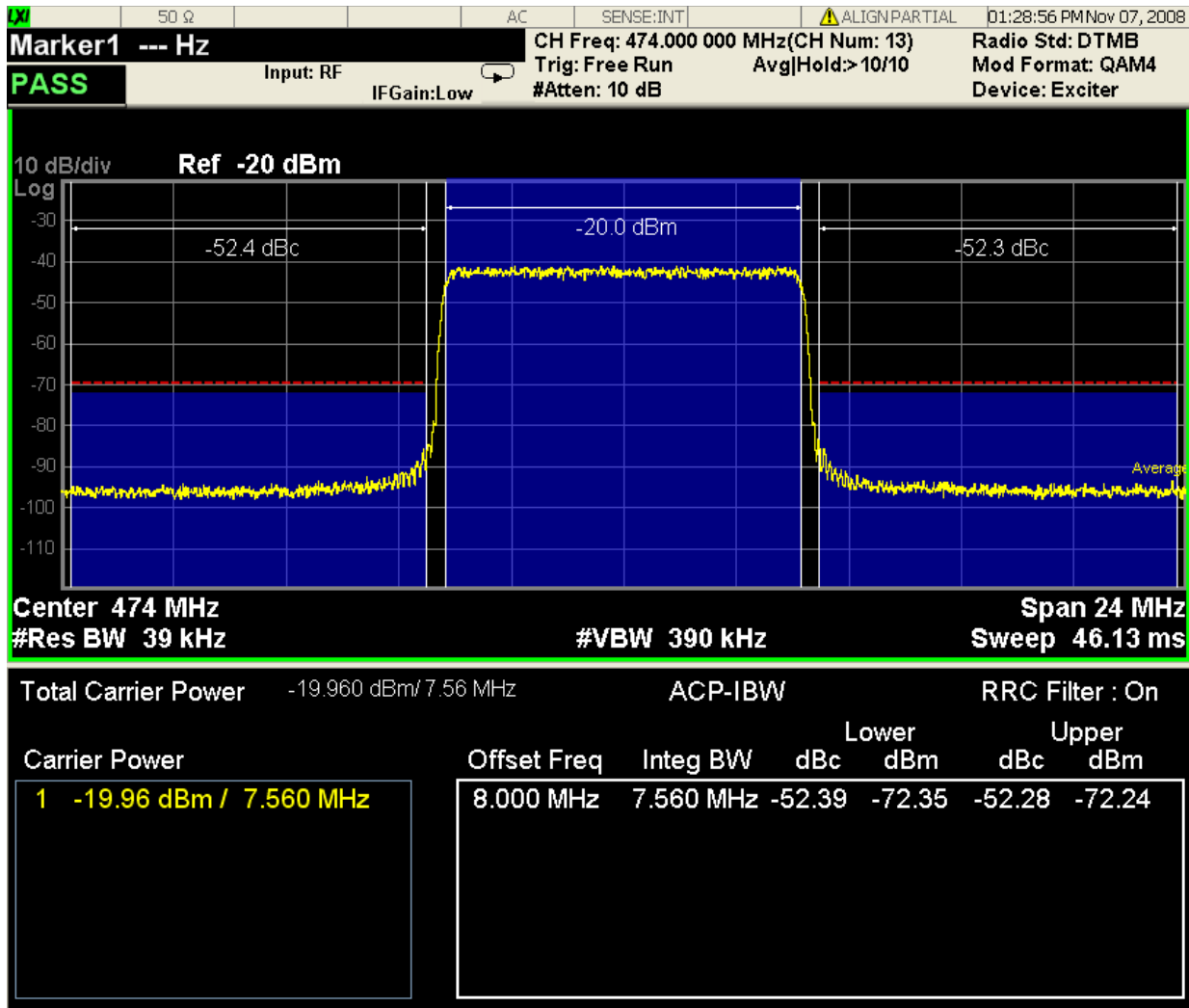

Spectrum Window

When the Bar Graph is On and Limit Test is On, the color of each bar graph reflects the limit test result. When the limit test fails, the bar color is red, and when limit test passes, the bar color is blue.

When RBW is selected as the measurement method, the spectrum trace is not displayed, only the bar graph is displayed. In addition, the Bar Graph key (under the View/Display front panel key) is set to ON and is grayed out.

The RRC Filter display item is only displayed when RRC filter is on.

Results Window

The text window displays the following results:

Total Carrier Power

This is the total power of all the carriers with carrier power present set to yes. The power is calculated by integrating across the bandwidth declared by the Carrier Integ Bw parameter for each carrier and then totaling the sums. The total integration bandwidth is shown as part of the result. This will be the total of the Carrier Integ Bw of the carriers used in calculating the total carrier power. If the RRC Filter is on, then the integration bandwidth used is $(1 + \alpha)/T$ where $T = 1/(\text{Carrier Integ Bw})$ multiplied by the number of carriers with carrier power present set to yes.

Ref Carrier Power

This is the power in the reference carrier. The power is calculated by integrating across the bandwidth declared by the Carrier Integ Bw parameter for that carrier. The integration bandwidth is shown as part of the result. This is the value of the Carrier Integ Bw for that carrier unless the RRC Filter is on, then the integration bandwidth used is the displayed value, which is $(1 + \alpha)/T$ where $T = 1/(\text{Carrier Integ Bw})$.

Carrier Power

This is the power in all the currently defined carriers. If the carrier has carrier power present, the power will be absolute. If the carrier is defined as not having power present, the power will be relative to the reference carrier. The power is calculated by integrating across the bandwidth declared by the Carrier Integ Bw parameter. The integration bandwidth is shown as part of the result. This is the value of the Carrier Integ Bw for the carrier unless the RRC Filter is on, then the integration bandwidth used is the displayed value, which is $(1 + \alpha)/T$ where $T = 1/(\text{Carrier Integ Bw})$.

As there are potentially more results than can be easily viewed on the display, a scrollable list is used to display all results. The Carrier Results menu key is used to index the carrier amplitude results. This key is grayed out unless the measurement is in single mode (as in continual measurement mode). The display is continuously updating and will not need to be accessed. The currently selected Carrier Result is displayed on the last line of the carrier power result list unless:

- The selected Carrier Result is 4 or less in normal multi carrier power results view. In this case the first 4 carrier power results will be displayed.
- The selected Carrier Result is 9 or greater in normal multi carrier power results view. In this case the last 4 carrier power results will be displayed.
- The zoom mode is selected. In this case all carrier power ranges can be displayed.

Offset Relative Power

This is the power in the offsets relative to the reference carrier. The power is calculated by integrating across the bandwidth declared by the Offset Integ Bw parameter. The offset integration bandwidth is shown as part of the result. This is the value on the Offset Integ Bw menu key unless the RRC Filter is on, then the integration bandwidth used is the displayed value, which is $(1 + \alpha)/T$ where $T = 1/(\text{Offset Integ Bw})$.

Offset Absolute Power

This is the absolute power in the offsets. The power is calculated by integrating across the bandwidth declared by the Offset Integ Bw parameter. The offset integration bandwidth is shown as part of the result. This is the value on the Offset Integ Bw menu key unless the RRC Filter is on, then the integration bandwidth used is the displayed value, which is $(1 + \alpha)/T$ where $T = 1/(\text{Offset Integ Bw})$.

Inside Adjacent Channel Power

ACP Measurement View/Display

This result is only valid for DTMB transmitter. It contains two parts: Relative Power and Absolute Power. The power is calculated by integrating across the bandwidth (Integ Bw) at the frequency Offset A.

Inside Absolute Power = MAX (P_{Lower Offset A}, P_{Upper Offset A});

Inside Relative Power = Inside Absolute Power – Carrier Power;

Outside Adjacent Channel Absolute Power

This result is only valid for DTMB transmitter. It contains two parts: Relative Power and Absolute Power. The power is the Root-Mean-Square of the power calculated by integrating across the bandwidth (Integ Bw) at frequency Offset B, C and D.

$$\text{Outside Absolute Power} = \sqrt{\frac{P_{\text{LowerOffsetB}}^2 + P_{\text{UpperOffsetB}}^2 + P_{\text{LowerOffsetC}}^2 + P_{\text{UpperOffsetC}}^2 + P_{\text{LowerOffsetD}}^2 + P_{\text{UpperOffsetD}}^2}{6}}$$

Outside Relative Power = Outside Absolute Power – Carrier Power;

Key Path	Front-panel key
Instrument S/W Revision	Prior to A.02.00

Display

Accesses a menu of functions that enable you to set the display parameters.

See “[Display](#)” on page 1307 in the "Common Measurement Functions" section for more information.

Key Path	View/Display
Instrument S/W Revision	Prior to A.02.00

Bar Graph

Turns the Bar Graph On and Off.

Remote Command	:DISPlay:ACPower:VIEW[1]:WINDow[1]:BGRaph OFF ON 0 1 :DISPlay:ACPower:VIEW[1]:WINDow[1]:BGRaph?
Example	DISP:ACP:VIEW:WIND:BGR OFF DISP:ACP:VIEW:WIND:BGR?
Dependencies/Couplings	When the method is RBW, this key is always set to On and grayed out.
Key Path	View/Display
Mode	SA, WCDMA, C2K, WIMAX OFDMA, TD-SCDMA, 1xEVDO, DVB-T/H, DTMB
Notes	You must be in the mode that includes ACP measurements to use this command. Use :INSTrument:SELEct to set the mode.

Preset	ON
State Saved	Saved in instrument state.
Range	On Off
Instrument S/W Revision	Prior to A.02.00

This measures the Power vs. Time of TD-SCDMA signal. You must be in the TD-CDMA mode to use these commands. For more details, see [Power vs Time Measurement Description](#) below.

This topic contains the following sections.

[Remote Commands for Power vs Time](#)

[Measurement Results for Power vs Time Measurement](#)

Remote Commands for Power vs Time

The following commands are used to retrieve the measurement results:

```
:CONFigure:PVTime
```

```
:CONFigure:PVTime:NDEFault
```

```
:INITiate:PVTime
```

```
:FETCh:PVTime [n] ?
```

```
:READ:PVTime [n] ?
```

```
:MEASure:PVTime [n] ?
```

Measurement Results for Power vs Time Measurement

For each result, the following heading is used to represent its format and precision.

#.Result Name (type of number) [unit] <explanation>

Type of number includes double, float and integer.

Index n	Results Returned
0	Returns unprocessed I/Q trace data as a series of comma-separated trace point values, in volts. The I values are listed first in each pair, using 0 through the even-indexed values. The Q values are odd-indexed values.

Power vs Time Measurement

n=1 (or not specified)

Returns the following comma-separated scalar results:

Sample time is a floating point number representing the time between samples of displayed trace which you can get by using the trace queries (n=2, 3, ...).

Number of samples is the number of data points in the displayed trace. This number is useful when performing a query on the signal (i.e. when n=2, 3, ...).

Mean Power is the mean power (in dBm) of the range specified by Analysis Time Slot and Measured Time Slots in the most recently acquired data, or in the last data acquired at the end of a set of averages.

Burst width is the width of the first set of continuous active slots in the range specified by Analysis Time slot and Measured Time Slots.

Trigger Diff is the time difference between the position of the trigger line and the -6 dB point of the positive slope of the start slot specified by Analysis Time Slot.

Ramp up time is the time difference between 10% and 90% voltage points (relative to peak) on the positive slope of the burst, here burst has the same meaning in Burst width.

Ramp down time is the time difference between 90% and 10% voltage points (relative to peak) on the negative slope of the burst, here burst has the same meaning in Burst width.

Off power is measured in accordance with the TSM spec procedure. The Tx Off Power Definition, the TSM 11.21 v310 std states:

“(1) Measure the RRC filtered mean power of the BTS output signal chipwise (i.e. averaged over time intervals of one chip duration) over the transmit off power period starting 11 chips before the start of the receive time slot $TS_i = U_{pPCH}$, and ending 8 chips before the next transmit time slot TS_{i+4} starts.”

In order to implement a measurement algorithm which would make the Tx Off Power measurement according to the above TSM spec statement (excluding the RRC filter requirement part), and yet also be able to be applied in a general way, irrespective of the "Meas Time" and "Traffic Slot" settings, and the signals active timeslots, the following Tx Off Power algorithm will be implemented:

“Measure the average power of the BTS or MS output signal over the transmit off power period region starting 11 chips before the start of any "inactive" time slot, and ending 8 chips before any following "active" time slot. Also if there are more than one "inactive" region, then just average all the "inactive" region results.

The result is averaged according to the Average Number, Average Mode, and Average Type parameter settings.

If all signal timeslots are determined to be “active”, the screen result is unavailable (four dashed lines are shown).

Maximum power is the maximum peak level in the range specified by Analysis Time Slot and Measured Time Slots (in dBm).

Minimum power is the minimum peak level in the range specified by Analysis Time Slot and Measured Time Slots (in dBm).

n=1 (or not specified)	(Continued) Actual sample time is the a floating point number representing the time between samples of uncompressed I/Q trace data, which could be get by using trace query(n=0). Actual number of samples is the number of data points in the uncompressed I/Q trace data, which could be get by using trace query(n=0).
2	Measured Trace data This returns comma-separated floating point numbers representing the Measured Trace data (in dBm).
3	Measured Max Hold Trace data This returns comma-separated floating point numbers representing the Measured Max Hold Trace data (in dBm).
4	Measured Min Hold Trace data This returns comma-separated floating point numbers representing the Measured Min Hold Trace data (in dBm).
5	Upper Mask Trace data This returns comma-separated floating point numbers representing the Upper Mask Trace data (in dBm).
6	Lower Mask Trace data This returns comma-separated floating point numbers representing the Lower Mask Trace data (in dBm).
7	Averaged absolute power of the slots This returns 9 comma-separated float values representing the averaged absolute power of each time slot (in dBm). For the inactive slot, the value will be -999. Averaged absolute power of TS0 Averaged absolute power of DwPTS Averaged absolute power of UpPTS Averaged absolute power of TS1 Averaged absolute power of TS2 Averaged absolute power of TS3 Averaged absolute power of TS4 Averaged absolute power of TS5 Averaged absolute power of TS6

8

Width of the slots

This returns 9 comma-separated float values representing the width of each time slot (in us). For the inactive slot, the value will be -999.

Active signal width of TS0

Active signal width of DwPTS

Active signal width of UpPTS

Active signal width of TS1

Active signal width of TS2

Active signal width of TS3

Active signal width of TS4

Active signal width of TS5

Active signal width of TS6

Power vs Time Measurement Description

The Power vs Time measurement analyzes the amplitude profile and timing of the burst signal and provides a time mask for the signal. This measurement meets the requirements for testing the sections of the standards documents listed in the table below.

Table 2.1 Test name and its reference standards documants

Document	Section	Test Name
3GPP TS 34.122 V4.2.0 (2001–12)	5.4.4	Transmit On/Off Time Mask
CWTS TSM 05.05 V.3.1.0 (2002–12)	4.1.1.5	Transmit On/Off Power
	4.1.2.4	
3GPP TS 34.122 V4.2.0 (2001–12)	5.4.3	Transmit Off Power
CWTS TSM 05.05 V.3.1.0 (2002–12)	4.1.1.5.1	Transmit Off Power
	4.1.2.6.1	
3GPP TS 34.122 V4.2.0 (2001–12)	5.4.2	Minimum Output Power
CWTS TSM 05.05 V.3.1.0 (2002–12)	4.1.1.3	Minimum Output Power
	4.1.2.3	
CWTS TSM 11.21 V.3.1.0 (2002–12)	6.5	Transmit ON/OFF Power

The transmitter signal is compared to a limit-line template, with standard compliant limits derived from the above specification documents. Limit pass or fail results are displayed at the completion of the measurement.

For averaged measurements, the user may specify the number of sweeps over which to average the result. This means that for an average number of 10, the power results are obtained from each trace, converted to linear (voltage squared), and then averaged with the previous average result before being displayed. The running average count and (the log of) the true averaged linear power will be displayed

after each measurement sweep.

Key Path	Front-panel key
Instrument S/W Revision	A.01.60 or later

Amplitude (AMPTD) Y Scale

The AMPLITUDE Y Scale key accesses the menu to set the desired vertical scale and associated settings.

Key Path	Front-panel key
Instrument S/W Revision	A.01.60 or later

Ref Value

Sets the absolute power reference.

Remote Command	:DISPlay:PVTime:VIEW[1]:WINDow[1]:TRACe:Y[:SCALe]:RLEV l <real> :DISPlay:PVTime:VIEW[1]:WINDow[1]:TRACe:Y[:SCALe]:RLEV l?
Dependencies/Couplings	When Y Auto Scale is set to On, this value is automatically determined by the measurement result. When you set this value manually, Y Auto Scale is automatically set to Off.
Example	DISP:PVT:VIEW:WIND:TRAC:Y:SCAL:RLEV 5dbm DISP:PVT:VIEW:WIND:TRAC:Y:SCAL:RLEV?
Key Path	AMPTD Y Scale
Mode	TD-SCDMA
Preset	10.00
State Saved	Saved in instrument state.
Min	-250.0
Max	250.0
Test MIN/MAX/DEF	Yes
Test UP/DOWN	Y Scale/Div value
Instrument S/W Revision	A.01.60 or later

Attenuation

This menu controls both the electrical and mechanical attenuators and their interactions. The value read back on the key in square brackets is the current Total (Elec + Mech) attenuation. When in Pre-Adjust for Min Clip mode, this value can change at the start of every measurement.

Operation of this key is identical across several measurements. For details about this key, see [“Attenuation” on page 1037](#) in the "Common Measurement Functions".

Scale/Div

Sets the units-per-division of the vertical scale in the logarithmic display. However, since the Auto Scale is defaulted to On, this value is automatically determined by the measurement result. When you set a value manually, Auto Scale automatically changes to Off.

Remote Command	<code>:DISPlay:PVTime:VIEW[1]:WINDow[1]:TRACe:Y[:SCALe]:PDIVi sion <rel_ampl></code> <code>:DISPlay:PVTime:VIEW[1]:WINDow[1]:TRACe:Y[:SCALe]:PDIVi sion?</code>
Dependencies/Couplings	When the Auto Scale is On, this value is automatically determined by the measurement result. When you set a value manually, Auto Scale automatically changes to Off.
Example	<code>DISP:PVT:VIEW:WIND:TRAC:Y:PDIV 5 dB</code> <code>DISP:PVT:VIEW:WIND:TRAC:Y:PDIV?</code>
Key Path	AMPTD Y Scale
Mode	TD-SCDMA
Preset	10.00 dB
State Saved	Saved in instrument state.
Min	0.10 dB
Max	20.00 dB
Test MIN/MAX/DEF	Yes
Test UP/DOWN	1, 2, 5, 10...
Instrument S/W Revision	A.01.60 or later

Presel Center

Operation of this key is identical across several measurements. For details about this key, see [“Presel Center” on page 1049](#) in the "Common Measurement Functions".

Presel Adjust

Operation of this key is identical across several measurements. For details about this key, see [“Preselector Adjust” on page 1050](#) in the "Common Measurement Functions".

Internal Preamp

Operation of this key is identical across several measurements. For details about this key, see [“Internal Preamp” on page 1052](#) in the "Common Measurement Functions".

Ref Position

Allows you to set the display reference position to the top, center, or bottom of the display.

Remote Command	<code>:DISPlay:PVTime:VIEW[1]:WINDow[1]:TRACe:Y[:SCALe]:RPOSi tion TOP CENTer BOTTom</code> <code>:DISPlay:PVTime:VIEW[1]:WINDow[1]:TRACe:Y[:SCALe]:RPOSi tion?</code>
Example	<code>:DISP:PVT:VIEW:WIND:TRAC:Y:SCAL:RPOS CENT</code> <code>:DISP:PVT:VIEW:WIND:TRAC:Y:SCAL:RPOS?</code>
Key Path	AMPTD Y Scale, More
Mode	TD-SCDMA
Preset	TOP
State Saved	Saved in instrument state.
Range	Top Ctr Bot
Instrument S/W Revision	A.01.60 or later

Auto Scale

Allows you to toggle the Y axis Auto Scale function between On and Off.

Remote Command	<code>:DISPlay:PVTime:VIEW[1]:WINDow[1]:TRACe:Y[:SCALe]:COUPl e 0 1 OFF ON</code> <code>:DISPlay:PVTime:VIEW[1]:WINDow[1]:TRACe:Y[:SCALe]:COUPl e?</code>
Dependencies/Couplings	When Auto Scale is On, and you press the Restart front-panel key, this function automatically determines the scale per division and reference values based on the measurement results. When you manually set a value for the Y Rel Value or Y Scale/Div, this parameter is automatically set to Off.
Example	<code>:DISP:PVT:VIEW:WIND:TRAC:Y:COUP ON</code> <code>:DISP:PVT:VIEW:WIND:TRAC:Y:COUP?</code>
Key Path	AMPTD Y Scale, More
Mode	TD-SCDMA
Preset	ON
State Saved	Saved in instrument state.
Range	On Off
Instrument S/W Revision	A.01.60 or later

Auto Couple

Operation of this key is identical across several measurements. For details about this key, see “[AUTO COUPLE](#)” on page 1055 in the "Common Measurement Functions".

BW

There is no BW functionality supported in the Power vs Time measurement.

Key Path	Front-panel key
Instrument S/W Revision	A.01.60 or later

Cont

Operation of this key is identical across several measurements. For details about this key, see “[Cont \(Continuous Measurement/Sweep\)](#)” on page 1059 in the "Common Measurement Functions".

FREQ Channel

Operation of this key is identical across several measurements. For details about this key, see “Frequency/Channel” on page 1061 for more information.

Input/Output

Operation of this key is identical across several measurements. For details about this key, see [“Input/Output” on page 1065](#) in the "Common Measurement Functions".

Marker

Accesses the menu that allows you to select, set up, and control the markers for the current measurement. Sets the marker control mode as described under **Normal**, **Delta**, and **Off**, below. All interactions and dependencies detailed under the softkey description are enforced when the remote command is sent.

See “**Marker**” on page 1123 in the "Common Measurement Functions" for more information.

Key Path	Front-panel key
Instrument S/W Revision	A.01.60 or later

Select Marker

Accesses a menu that allows you to activate one or more markers

See Marker in the “Marker Functions” section for more information.

Key Path	Front panel key
Instrument S/W Revision	A.01.60 or later

Marker Type

Sets the marker control mode. If the selected marker is Off, pressing Marker sets it to Normal and places it at the center of the screen on the trace determined by the **Marker Trace** rules. At the same time, the reference value of the selected marker appears on the Active Function area.

Active Function Display: Marker X-axis value

Default Active Function: the active function for the selected marker’s current control mode. If the current control mode is Off, there is no active function and the active function is turned off.

The marker X axis value entered in the active function area will display the marker value to its full entered precision.

Remote Command	:CALCulate:PVTime:MARKer [1] 2 3 4 5 6 7 8 9 10 11 12 :MO DE POSition DELTA OFF :CALCulate:PVTime:MARKer [1] 2 3 4 5 6 7 8 9 10 11 12 :MO DE?
Example	:CALC:PVT:MARK:MODE OFF :CALC:PVT:MARK:MODE?
Key Path	Marker
Mode	TD-SCDMA

Notes	<p>If the selected marker is Off, pressing Marker sets it to Normal and places it at the center of the screen on the trace determined by the Marker Trace rules. At the same time, Marker X Axis Value appears in the Active Function area.</p> <p>Default Active Function: the active function for the selected marker's current control mode. Note that if the current control mode is Off, there is no active function and the active function is turned off.</p> <p>Active Function Display: the marker X axis value entered in the active function area will display the marker value to its fully entered precision.</p>
Preset	OFF
State Saved	Saved in instrument state.
Range	Normal Delta Off
Test MIN/MAX/DEF	Yes
Instrument S/W Revision	A.01.60 or later

Marker X Axis Value

Sets the marker X Axis value in the current marker X Axis Scale unit. It has no effect if the control mode is **Off**, but is the SCPI equivalent of entering an X value, if the control mode is **Normal** or **Delta**.

Remote Command	<pre>:CALCulate:PVTtime:MARKer [1] 2 3 4 5 6 7 8 9 10 11 12 :X <real></pre> <pre>:CALCulate:PVTtime:MARKer [1] 2 3 4 5 6 7 8 9 10 11 12 :X?</pre>
Dependencies/Couplings	Max value would be changed by Meas Time parameter value.
Example	<pre>:CALC:PVT:MARK3:X 0</pre> <pre>:CALC:PVT:MARK3:X?</pre>
Key Path	Marker, Select Marker
Mode	TD-SCDMA
Notes	<p>If no suffix is sent, it will use the fundamental units for the current marker X Axis Scale. If a suffix is sent that does not match the current marker X Axis Scale unit, an "Invalid suffix" error will be generated.</p> <p>The query returns the marker's absolute X Axis value if the control mode is Normal, or the offset from the marker's reference marker, if the control mode is Delta. The query is returned in the fundamental units for the current marker X Axis scale: seconds. If the marker is off the response is not a number (NAN).</p>
Preset	After a preset, all markers are turned OFF, so a Marker X Axis Value query will return a not a number (NAN).
State Saved	No
Min	-9.9E+37

Power vs Time Measurement Marker

Max	9.9E+37
Test MIN/MAX/DEF	MIN MAX
Test UP/DOWN	step unit is “0.1us”.
Instrument S/W Revision	A.01.60 or later

Marker X Axis Position (Remote Command only)

Sets the marker X position in trace points. This allows you to enter a value in trace points rather than in X Axis Scale units. The entered value is immediately converted into the current X Axis Scale unit for setting the value of the marker. It has no effect if the control mode is **Off**, but is the SCPI equivalent of entering an X value, if the control mode is **Normal** or **Delta**.

Remote Command	:CALCulate:PVTime:MARKer [1] 2 3 4 5 6 7 8 9 10 11 12 : X : POSITION <real> :CALCulate:PVTime:MARKer [1] 2 3 4 5 6 7 8 9 10 11 12 : X : POSITION?
Example	:CALC:PVT:MARK10:X:POS 500 :CALC:PVT:MARK10:X:POS?
Mode	TD-SCDMA
Notes	A query returns the marker’s absolute X Axis value in trace points, if the control mode is Normal , or the offset from the marker’s reference marker in trace points, if the control mode is Delta . If the marker is Off the response is not a number (NAN).
Preset	After a preset, all markers are turned Off, so a Marker X Axis Value query will return a not a number (NAN).
State Saved	No
Min	-9.9E+37
Max	9.9E+37
Test MIN/MAX/DEF	MIN MAX
Test UP/DOWN	The step unit is “1”.
Instrument S/W Revision	A.01.60 or later

Marker Y Axis Value (Remote Command only)

Returns the marker Y Axis value in the current marker Y Axis unit.

The “result” of a marker is the value that is displayed on the second line of the Marker Result block. To properly interpret the returned value, you must also know how the analyzer’s Y-Axis Unit is set, as described below.

A marker can have up to two results, only one of which is displayed or returned in a query, as follows:

- Absolute result: every marker has an absolute result. For Normal and Delta markers, the Y-axis value of the trace point the marker is currently On. The absolute result is displayed in the result block or returned as a query, unless the marker control mode is **Delta**.
- Relative result: if a marker's control mode is **Delta**, the relative result is displayed in the result block or returned in a query. This is the ratio of the Absolute Result of a delta marker to the Absolute Result of its reference marker. The ratio is expressed in dB.
-

Remote Command	:CALCulate:PVTTime:MARKer [1] 2 3 4 5 6 7 8 9 10 11 12 :Y?
Example	:CALC:PVT:MARK11:Y 0 :CALC:PVT:MARK11:Y?
Mode	TD-SCDMA
Notes	The query returns the marker Y-axis result. If the marker is Off the response is not a number (NAN).
Preset	0
State Saved	No
Test MIN/MAX/DEF	No
Instrument S/W Revision	A.01.60 or later

Properties

Accesses a menu that allows you to set marker properties and to access the marker trace menu.

Key Path	Marker
Instrument S/W Revision	A.01.60 or later

Select Marker

Accesses menus that allows you to select one or more markers

Key Path	Marker, Properties
Instrument S/W Revision	A.01.60 or later

Relative To

Selects the marker that the selected marker will be relative to, which is referred to as its “reference marker”.

Remote Command	:CALCulate:PVTTime:MARKer [1] 2 3 4 5 6 7 8 9 10 11 12 :RE FERENCE <integer> :CALCulate:PVTTime:MARKer [1] 2 3 4 5 6 7 8 9 10 11 12 :RE FERENCE?
-----------------------	---

Power vs Time Measurement
Marker

Example	:CALC:PVT:MARK5:REF 1 :CALC:PVT:MARK5:REF?
Key Path	Marker, Properties
Mode	TD-SCDMA
Notes	When queried, a single value will be returned - the specified marker number's relative marker.
Preset	2 3 4 5 6 7 8 9 10 11 12 1
State Saved	Saved in instrument state.
Min	1
Max	12
Test MIN/MAX/DEF	Yes
Test UP/DOWN	1
Instrument S/W Revision	A.01.60 or later

Marker Trace

Assigns the specified marker to the designated trace.

Remote Command	:CALCulate:PVTime:MARKer [1] 2 3 4 5 6 7 8 9 10 11 12 : TRACe RFENvelope UMASK LMASK MAXHold MINHold :CALCulate:PVTime:MARKer [1] 2 3 4 5 6 7 8 9 10 11 12 : TRACe?
Example	:CALC:PVT:MARK:TRAC MINH :CALC:PVT:MARK:TRAC?
Key Path	Marker, Properties
Mode	TD-SCDMA
Preset	RFENvelope
State Saved	Saved in instrument state.
Range	RF Envelope Upper Mask Lower Mask Max Hold RF Envelope Min Hold RF Envelope
Test MIN/MAX/DEF	Yes
Instrument S/W Revision	A.01.60 or later

Couple Marker

When this function is invoked, moving any marker causes an “equal X Axis movement” of every other marker which is active. By “equal X Axis movement” we mean that the difference between each marker’s X Axis value (in the fundamental x-axis units of the trace that marker is on) is preserved, as is

the X Axis value of the marker being moved (in the same fundamental X-axis units).

NOTE This may result in markers going off screen.

Remote Command	:CALCulate:PVTtime:MARKer:COUPle[:STATe] ON OFF 1 0 :CALCulate:PVTtime:MARKer:COUPle[:STATe]?
Example	CALC:PVT:MARK:COUP ON CALC:PVT:MARK:COUP?
Key Path	Marker, More
Mode	TD-SCDMA
Preset	OFF
State Saved	Saved in instrument state.
Range	On Off
Test MIN/MAX/DEF	Yes
Instrument S/W Revision	A.01.60 or later

All Markers Off

Turns all markers Off.

Remote Command	:CALCulate:PVTtime:MARKer:AOFF
Example	:CALC:PVT:MARK:AOFF
Key Path	Marker, More
Mode	TD-SCDMA
Instrument S/W Revision	A.01.60 or later

Marker State (Remote Command Only)

Sets or queries the state of a marker. Setting a marker which is Off to state On, or 1, puts it in Normal mode and places it at the center of the screen.

Mode	TD-SCDMA
Remote Command	:CALCulate:PVTtime:MARKer[1] 2 3 4 5 6 7 8 9 10 11 12:STATe OFF ON 0 1 :CALCulate:PVTtime:MARKer[1] 2 3 4 5 6 7 8 9 10 11 12:STATe?
Preset	OFF

Power vs Time Measurement
Marker

State Saved	Saved in instrument state.
Range	On Off
Example	:CALC:PVT:MARK3:STATE ON :CALC:PVT:MARK3:STATE?
Instrument S/W Revision	A.01.60 or later

Marker Fctn

There are no 'Marker Functions' supported in Power vs. Time measurement. Pressing this key will display a blank menu.

Key Path	Front-panel key
Instrument S/W Revision	A.01.60 or later

Marker To

There is no 'Marker To' functionality supported in Power vs. Time so this front-panel key will display a blank menu when pressed

Key Path	Front-panel key
Instrument S/W Revision	A.01.60 or later

Meas

Operation of this key is identical across several measurements. For details about this key, see [“Meas” on page 1127](#) in the "Common Measurement Functions".

Meas Setup

Accesses the measurement setup menu for the current measurement.

Key Path	Front-panel key
Instrument S/W Revision	A.01.60 or later

Avg/Hold Num

Used to specify the number of data acquisitions that will be averaged. After the specified number of average counts, the averaging mode (termination control) setting determines the averaging action.

- On - Sets measurement averaging on.
- Off - Sets measurement averaging off.
-

Remote Command	<code>[:SENSe] :PVTime:AVERAge:COUNT <integer></code>
	<code>[:SENSe] :PVTime:AVERAge:COUNT?</code>
	<code>[:SENSe] :PVTime:AVERAge [:STATe] OFF ON 0 1</code>
	<code>[:SENSe] :PVTime:AVERAge [:STATe] ?</code>

Example	<code>:SENS:PVT:AVER:COUN 10</code>
	<code>:SENS:PVT:AVER:COUN?</code>
	<code>:SENS:PVT:AVER:STAT OFF</code>
	<code>:SENS:PVT:AVER:STAT?</code>

Key Path	Meas Setup
Mode	TD-SCDMA
Preset	10
	OFF
State Saved	Saved in instrument state.
Min	1
Max	10000
Test MIN/MAX/DEF	Yes
Test UP/DOWN	1
Instrument S/W Revision	A.01.60 or later

Avg Mode

Selects the type of termination control used for the averaging function. This determines the averaging action after the specified number of data acquisitions (average count) is reached.

KEY:Exponential SCPI:EXponential	After the average count is reached, each successive data acquisition is exponentially weighted and combined with the existing average.
KEY:Repeat SCPI:REPeat	After reaching the average count, the averaging is reset and a new average is started. The default value is Exp.

Remote Command [:SENSe]:PVT:AVER:TCOnTrol EXPONENTIAL|REPEAT
[:SENSe]:PVT:AVER:TCOnTrol?

Example :SENS:PVT:AVER:TCOn REP
:SENS:PVT:AVER:TCOn?

Key Path	Meas Setup
Mode	TD-SCDMA
Preset	REPeat
State Saved	Saved in instrument state.
Range	Exp Repeat
Instrument S/W Revision	A.01.60 or later

Avg Type

Specifies the type of trace and result averaging to use.

KEY:Pwr Avg (RMS) SCPI:RMS POWer	True power averaging that is equivalent to taking the RMS value of the voltage. It is the most accurate type of averaging.
KEY:Log-Pwr Avg (Video) SCPI:LOG LPOWer	Simulates the traditional spectrum analyzer type of averaging by averaging the log of the power.

Remote Command [:SENSe]:PVT:AVER:TYPE LOG|LPOWer|RMS|POWer
[:SENSe]:PVT:AVER:TYPE?

Example :SENS:PVT:AVER:TYPE RMS
:SENS:PVT:AVER:TYPE?

Key Path	Meas Setup
Mode	TD-SCDMA

Power vs Time Measurement Meas Setup

Preset	RMS
State Saved	Saved in instrument state.
Range	Pwr Avg (RMS) Log-Pwr Avg(Video)
Instrument S/W Revision	A.01.60 or later

Meas Interval

Specifies the measurement interval in an integer number of slots.

Remote Command	<code>[[:SENSE]:PVTime:SWEep:TIME <integer></code> <code>[[:SENSE]:PVTime:SWEep:TIME?</code>
Dependencies/Couplings	If trigger source was set to RFBurst, this button will be grayed.
Example	<code>:SENS:PVT:SWE:TIME 1</code> <code>:SENS:PVT:SWE:TIME?</code>
Key Path	Meas Setup
Mode	TD-SCDMA
Preset	1
State Saved	Saved in instrument state.
Min	1
Max	9
Test MIN/MAX/DEF	Yes
Test UP/DOWN	1
Instrument S/W Revision	A.01.60 or later

IF Gain

Accesses the menu that sets ranging in the digital IF when acquiring an I/Q time record.

See [More Information about IF Gain](#).

NOTE This function is not affected by RF Input Range attenuation.

Key Path	Meas Setup
Instrument S/W Revision	A.01.60 or later

More Information about IF Gain

To take full advantage of the RF dynamic range of the analyzer, you can manually turn on or turn off a

switched digital IF amplifier. When it is turned on, the signal will get approximately 10 dB of gain.

- Setting IF Gain to Man and selecting High Gain will turn on the digital IF amplifier and get an extra 10 dB gain.
- Setting IF Gain to Auto will activate the Auto rules for IF Gain.

These settings affect sensitivity and IF overloads.

IF Gain Auto

Activates the Auto Rules for IF Gain. When Auto is active, the IF Gain is set to High Gain under any of the following conditions:

- the input attenuator is set to 0 dB
- the preamp is turned On
- the Max Mixer Level is 20 dBm or lower

For other settings, Auto sets IF Gain to Off.

Remote Command	<code>[:SENSE] :PVT:ime:IF:GAIN:AUTO [:STATe] ON OFF 1 0</code> <code>[:SENSE] :PVT:ime:IF:GAIN:AUTO [:STATe] ?</code>
Dependencies/Couplings	When either the auto attenuation is active (for example, with an electrical attenuator), or the optimize mechanical attenuator range is requested, the IF Gain setting is changed using the following rule. The Auto selection sets IF Gain On under any of the following conditions: <ul style="list-style-type: none"> • the input attenuator is set to 0 dB • the preamp is turned on, • the Max Mixer Level is 20 dBm or lower. For other settings, Auto sets IF Gain to Off.
Example	PVT:IF:GAIN:AUTO ON PVT:IF:GAIN:AUTO?
Key Path	Meas Setup,IF Gain
Mode	TD-SCDMA
Preset	OFF
State Saved	Saved in instrument state.
Range	Auto Man
Instrument S/W Revision	A.01.60 or later

IF Gain State

Selects the range of IF gain.

- On sets the high gain option, which allows for better noise level measurements.

Power vs Time Measurement Meas Setup

- Off sets low gain when measuring large signals.

When this parameter is changed manually from front panel, IF Gain Auto will become Man.

Remote Command	<code>[:SENSe] :PVTime:IF:GAIN [:STATe] ON OFF 1 0</code> <code>[:SENSe] :PVTime:IF:GAIN [:STATe] ?</code>
Example	<code>PVT:IF:GAIN ON</code> <code>PVT:IF:GAIN?</code>
Key Path	Meas Setup, IF Gain
Mode	SA, WCDMA, C2K, WIMAXOFDMA, TD-SCDMA
Notes	where ON = high gain OFF = low gain
Preset	OFF
State Saved	Saved in instrument state.
Range	Low Gain (Best for Large Signals) High Gain (Best Noise Level)
Instrument S/W Revision	A.01.60 or later

Meas Preset

Returns parameters for the current measurement to those set by the factory.

Remote Command	<code>:CONFigure:PVTime</code>
Example	<code>:CONF:PVT</code>
Key Path	Meas Setup, More
Mode	TD-SCDMA
Instrument S/W Revision	A.01.60 or later

Limit Mask Selection (Remote Command only)

Chooses whether the limit masks used will be the default, standard-compliant values or the user-defined values. When set to CUSTom, the mask used will be the one described by these programming commands:

Remote Command	<code>[:SENSe] :PVTime:MASK:SElect CUSTom STANdard</code> <code>[:SENSe] :PVTime:MASK:SElect ?</code>
Example	<code>:SENSe:PVTime:MASK:SElect CUSTom</code>
Mode	TD-SCDMA

Notes	Choose whether the limit masks used will be the default, standard-compliant values or the user-defined values. When set to CUSTom, the mask used will be the one described by these programming commands: [:SENSe]:PVTime:MASK:LIST:LOWer:ABSolute [:SENSe]:PVTime:MASK:LIST:UPPer:ABSolute [:SENSe]:PVTime:MASK:LIST:LOWer:RELative [:SENSe]:PVTime:MASK:LIST:UPPer:RELative [:SENSe]:PVTime:MASK:LIST:LOWer:TIME [:SENSe]:PVTime:MASK:LIST:UPPer:TIME
Preset	STANdard
State Saved	Saved in instrument state.
Range	CUSTom STANdard
Test MIN/MAX/DEF	No
Instrument S/W Revision	A.01.60 or later

Lower Mask Absolute Amplitude Levels (Remote Command only)

Specifies a power level for any mask line segments that require an absolute minimum power limit.

Remote Command	[:SENSe] :PVTime:MASK:LIST:LOWer:ABSolute <ampl>, <ampl>, <ampl>, <ampl> [:SENSe] :PVTime:MASK:LIST:LOWer:ABSolute?
Example	:SENS:PVT:MASK:LIST:LOW:ABS -130, -130, -130, -130 :SENS:PVT:MASK:LIST:LOW:ABS?
Mode	TD-SCDMA

Power vs Time Measurement
Meas Setup

Notes	<p>Enter a power level for any mask line segments that require an absolute minimum power limit. Each time a measurement is made the Ref Level is determined, (this is the power level of the useful part of the burst). As the power of the Ref Level changes, all of the relative mask power levels will change by the same amount. Each relative limit is then compared to the Ref Level and an equivalent absolute power level is calculated. This power level is compared to the specified absolute limit for each line segment. If this calculated relative limit is lower than the absolute limit specified, the value of the absolute limit is used for this segment. If the absolute limit is set to a very low value (–200 dBm), the calculated value of the reference limit will never be lower, and the specified relative limit will always be used for that segment. Every time point defined with PVT:MASK:LOW:TIME must have a power value defined in the same order.</p> <p>When setting these values remotely, the position in the list sent corresponds to the offset. Missing values are not permitted i.e. if you want to change values 2 and 4 you must send all values up to 4. Subsequent values will remain unchanged, unless the number of values sent is greater than the number of carriers, then subsequent values will be ignored.</p>
Preset	–200, –200, –200, –200
State Saved	Saved in instrument state.
Min	–200
Max	100
Test MIN/MAX/DEF	No
Instrument S/W Revision	A.01.60 or later

Lower Mask Points (Remote Command only)

Query the number of elements in the lower mask. This value is determined by the number of time points entered using [:SENSe]:PVTime:MASK:LIST:LOWer:TIME.

Remote Command	[:SENSe]:PVTime:MASK:LIST:LOWer:POINTs?
Example	:SENSe:PVTime:MASK:LIST:LOWer:POINTs?
Mode	TD-SCDMA
Notes	No corresponding command
State Saved	Saved in instrument state.
Min	1
Max	25
Test MIN/MAX/DEF	No
Instrument S/W Revision	A.01.60 or later

Lower Mask Relative Amplitude Levels (Remote Command only)

Sets the lower mask relative amplitude levels.

Remote Command	[:SENSe]:PVTime:MASK:LIST:LOWer:RELative <ampl>, <ampl>, <ampl>, <ampl> [:SENSe]:PVTime:MASK:LIST:LOWer:RELative?
Example	:SENS:PVT:MASK:LIST:LOW:REL 130, 130, 130 130 :SENS:PVT:MASK:LIST:LOW:REL?
Mode	TD-SCDMA
Notes	Enter the relative power level for each horizontal line segment in the lower limit mask. There should be a power level for each time point entered using :PVTime:MASK:LIST:LOWer:TIME, and they must be entered in the same order. These power levels are all relative to the defined Reference Power Level (the average power in the useful part of the data). When setting these values remotely, the position in the list sent corresponds to the offset. Missing values are not permitted i.e. if you want to change values 2 and 4 you must send all values up to 4. Subsequent values will remain unchanged, unless the number of values sent is greater than the number of carriers, then subsequent values will be ignored.
Preset	100, 100, 100, 100
State Saved	Saved in instrument state.
Min	-200
Max	100
Test MIN/MAX/DEF	No
Instrument S/W Revision	A.01.60 or later

Lower Mask Time Points (Remote Command only)

Sets lower mask time points.

Remote Command	[:SENSe]:PVTime:MASK:LIST:LOWer:TIME <time>, <time>, <time>, <time> [:SENSe]:PVTime:MASK:LIST:LOWer:TIME?
Example	:SENSe:PVTime:MASK:LIST:LOWer:TIME -1.0, -.5, 0, 0.5, 1.0
Mode	TD-SCDMA

Power vs Time Measurement Meas Setup

Notes	<p>Enter the value on the X-Axis at which the next segment of the mask begins. The leftmost value on the X-Axis is the value of the trigger delay (which may be positive or negative), and is shown on the display as an annotation on the X-Axis.</p> <p>Selecting a large time value for the first and last mask points (e.g. -1 and +1 second) guarantees a limit is defined for all measured data.</p> <p>When setting these values remotely, the position in the list sent corresponds to the offset. Missing values are not permitted i.e. if you want to change values 2 and 4 you must send all values up to 4. Subsequent values will remain unchanged, unless the number of values sent is greater than the number of carriers, then subsequent values will be ignored.</p>
Preset	0, 0, 0, 0
State Saved	Saved in instrument state.
Min	-1
Max	1
Test MIN/MAX/DEF	No
Instrument S/W Revision	A.01.60 or later

Upper Mask Absolute Amplitude Levels (Remote Command only)

Sets upper mask absolute amplitude levels.

Remote Command	<pre>[:SENSe] :PVTime:MASK:LIST:UPPer:ABSolute <ampl>, <ampl>, <ampl>, <ampl> [:SENSe] :PVTime:MASK:LIST:UPPer:ABSolute?</pre>
Example	<pre>:SENS:PVT:MASK:LIST:UPP:ABS -130, -130, -130 -130 :SENS:PVT:MASK:LIST:UPP:ABS?</pre>
Mode	TD-SCDMA

Notes Enter a power level for any of your mask line segments that require an absolute minimum power limit in addition to its relative limit. Each time a measurement is made the Ref Level is determined. (This is the power level of the useful part of the burst, or midway between the upper/lower masks). As the power of the Ref Level changes, all of the relative mask power levels will change by the same amount. Each relative limit is then compared to the Ref Level and an equivalent absolute power level is calculated. This power level is compared to the specified absolute limit for each line segment. If this calculated relative limit is lower than the absolute limit specified, the value of the absolute limit is used for this segment. If the absolute limit is set to a very low value (–200 dBm), the calculated value of the reference limit will never be lower, and the specified relative limit will always be used for that segment. Every time point defined with PVT:MASK:LOW:TIME must have a power value defined in the same order. A comma may be used in the SCPI command as a place holder for any points where an absolute power is not specified. The default value will then be used for that segment.

When setting these values remotely, the position in the list sent corresponds to the offset. Missing values are not permitted i.e. if you want to change values 2 and 4 you must send all values up to 4. Subsequent values will remain unchanged, unless the number of values sent is greater than the number of carriers, then subsequent values will be ignored.

Preset	–200, –200, –200, –200
State Saved	Saved in instrument state.
Min	–200
Max	100
Test MIN/MAX/DEF	No
Instrument S/W Revision	A.01.60 or later

Upper Mask Points (Remote Command only)

Query the number of elements in the upper mask. This value is determined by the number of time points entered using [:SENSe]:PVT:MASK:LIST:UPPer:TIME.

Remote Command	[:SENSe]:PVT:MASK:LIST:UPPer:POINTs?
Example	:SENS:PVT:MASK:LIST:UPP:POIN?
Mode	TD-SCDMA
State Saved	Saved in instrument state.
Min	1
Max	25
Test MIN/MAX/DEF	No
Instrument S/W Revision	A.01.60 or later

Upper Mask Relative Amplitude Levels (Remote Command only)

Sets upper mask relative amplitude levels.

Remote Command	<code>[[:SENSE]:PVTime:MASK:LIST:UPPER:RELATIVE <rel_ampl>, <rel_ampl>, <rel_ampl>, <rel_ampl></code> <code>[[:SENSE]:PVTime:MASK:LIST:UPPER:RELATIVE?</code>
Example	<code>:SENS:PVT:MASK:LIST:UPPER:REL -130, -130, -130 -130</code> <code>:SENS:PVT:MASK:LIST:UPPER:REL?</code>
Mode	TD-SCDMA
Notes	Enter the relative power level for each horizontal line segment in the upper limit mask. There should be a power level for each time point entered using PVTime:MASK:LIST:UPPER:TIME, and they must be entered in the same order. These power levels are all relative to the defined Reference Power Level (the average power in the useful part of the data). When setting these values remotely, missing values are not permitted i.e. if you want to change values 2 and 4 you must send all values up to 4. Subsequent values will remain unchanged.
Preset	100, 100, 100, 100
State Saved	Saved in instrument state.
Min	-200
Max	100
Test MIN/MAX/DEF	No
Instrument S/W Revision	A.01.60 or later

Upper Mask Time Points (Remote Command only)

Sets upper mask time points.

Remote Command	<code>[[:SENSE]:PVTime:MASK:LIST:UPPER:TIME <time>, <time>, <time>, <time></code> <code>[[:SENSE]:PVTime:MASK:LIST:UPPER:TIME?</code>
Example	<code>:SENS:PVT:MASK:LIST:UPPER:TIME -1.0, -0.5, 0.5, 1.0</code> <code>:SENS:PVT:MASK:LIST:UPPER:TIME?</code>
Mode	TD-SCDMA

Notes	<p>Enter the value on the X-Axis at which the next segment of the mask begins. The leftmost value on the X-Axis is the value of the trigger delay (which may be positive or negative), and is shown on the display as an annotation on the X-Axis.</p> <p>Selecting a large time value for the first and last mask points (e.g. -1 and +1 second) guarantees a limit is defined for all measured data.</p> <p>When setting these values remotely, the position in the list sent corresponds to the offset. Missing values are not permitted i.e. if you want to change values 2 and 4 you must send all values up to 4. Subsequent values will remain unchanged, unless the number of values sent is greater than the number of carriers, then subsequent values will be ignored.</p>
Preset	0, 0, 0, 0
State Saved	Saved in instrument state.
Min	-1.0
Max	1.0
Test MIN/MAX/DEF	No
Instrument S/W Revision	A.01.60 or later

Mode

Operation of this key is identical across several measurements. For details about this key, see [“Mode” on page 1145](#) in the "Common Measurement Functions".

Mode Setup

Operation of this key is identical across several measurements. For details about this key, see “[Mode Setup](#)” on page 1159 in the "Common Measurement Functions".

Peak Search

There is no Peak Search functionality supported in the Power vs Time measurement.

Key Path	Front-panel key
Instrument S/W Revision	A.01.60 or later

Recall

Operation of this key is identical across several measurements. For details about this key, see [“Recall” on page 1179](#) in the "Common Measurement Functions".

Restart

Operation of this key is identical across several measurements. For details about this key, see “[Restart](#)” on page 1201 in the "Common Measurement Functions".

Save

Operation of this key is identical across several measurements. For details about this key, see [“Save” on page 1203](#) in the "Common Measurement Functions".

Single

Operation of this key is identical across several measurements. For details about this key, see [“Single \(Single Measurement/Sweep\)”](#) on page 1229 in the "Common Measurement Functions".

Source

There is no Source functionality.

Key Path	Front-panel key
Instrument S/W Revision	A.01.60 or later

SPAN X Scale

Accesses a menu of functions that enable you set the horizontal scale parameters.

Key Path	Front-panel key
Instrument S/W Revision	A.01.60 or later

Ref Value

Allows you to set the display X reference value.

Remote Command	:DISPlay:PVTime:VIEW[1]:WINDow[1]:TRACe:X[:SCALe]:RLEVe l <time> :DISPlay:PVTime:VIEW[1]:WINDow[1]:TRACe:X[:SCALe]:RLEVe l?
Dependencies/Couplings	See Restriction and Notes
Example	DISP:PVT:VIEW:WIND:TRACE:X:RLEV 1s DISP:PVT:VIEW:WIND:TRACE:X:RLEV?
Key Path	SPAN X Scale
Mode	TD-SCDMA
Notes	If X Auto Scale is On, this value is automatically determined by the measurement result. When a value is set manually, X Auto Scale is automatically set to Off.
Preset	0 s
State Saved	Saved in instrument state.
Min	-10.0 s
Max	10.00 s
Test MIN/MAX/DEF	Yes
Test UP/DOWN	200.0 us
Instrument S/W Revision	A.01.60 or later

Scale/Div

Allows you to set the display X scale/division value.

Remote Command	:DISPlay:PVTime:VIEW[1]:WINDow[1]:TRACe:X[:SCALe]:PDIVi sion <time> :DISPlay:PVTime:VIEW[1]:WINDow[1]:TRACe:X[:SCALe]:PDIVi sion?
MIN/MAX/DEF Support	Yes
Dependencies/Couplings	See Restriction and Notes
Example	:DISP:PVT:VIEW:WIND:TRACE:X:PDIV 1ms :DISP:PVT:VIEW:WIND:TRACE:X:PDIV?
Key Path	SPAN X Scale
Mode	TD-SCDMA
Notes	If X Auto Scale is set to On, this value is automatically determined by the measurement result. When a value is set manually, X Auto Scale is automatically set to Off.
Preset	1.0 ms
State Saved	Saved in instrument state.
Min	1.00 ns
Max	1.00 s
Test MIN/MAX/DEF	MIN MAX
Test UP/DOWN	Step follows the “1,2,5,10 ... Rule”
Instrument S/W Revision	A.01.60 or later

Ref Position

Allows you to set the X reference position to the left, center, or right of the display.

Remote Command	:DISPlay:PVTime:VIEW[1]:WINDow[1]:TRACe:X[:SCALe]:RPOSi tion LEFT CENTer RIGHT :DISPlay:PVTime:VIEW[1]:WINDow[1]:TRACe:X[:SCALe]:RPOSi tion?
Example	:DISP:PVT:VIEW:WIND:TRACE:X:RPOS LEFT :DISP:PVT:VIEW:WIND:TRACE:X:RPOS?
Key Path	SPAN X Scale
Mode	TD-SCDMA
Preset	LEFT

Power vs Time Measurement
SPAN X Scale

State Saved	Saved in instrument state.
Range	Left Ctr Right
Instrument S/W Revision	A.01.60 or later

Auto Scale

Allows you to toggle the X Auto Scale function between On and Off.

Remote Command	:DISPlay:PVTime:VIEW[1]:WINDow[1]:TRACe:X[:SCALe]:COUPL e 0 1 OFF ON :DISPlay:PVTime:VIEW[1]:WINDow[1]:TRACe:X[:SCALe]:COUPL e?
Dependencies/Couplings	See Restriction and Notes
Example	:DISP:PVT:VIEW:WIND:TRAC:X:COUP OFF :DISP:PVT:VIEW:WIND:TRAC:X:COUP?
Key Path	SPAN X Scale
Mode	TD-SCDMA
Notes	Upon pressing the Restart front-panel key, the scale coupling function automatically determines the scale per division and reference values, based on the measurement results, if this parameter is set to On. When you manually set a value to either X Rel Value or X Scale/Div, X Auto Scale is automatically set to Off.
Preset	ON
State Saved	Saved in instrument state.
Range	On Off
Instrument S/W Revision	A.01.60 or later

Sweep/Control

Operation of this key is identical across several measurements. For details about this key, see [“Sweep / Control” on page 1235](#) in the "Common Measurement Functions".

NOTE Gate function is not supported in the Modulation Accuracy measurement.

Key Path	SPAN X Scale
Mode	TD-SCDMA

Abort (Remote Command Only)

See [“Abort \(Remote Command Only\)” on page 1235](#) in the section "Common Measurement Functions" for more information.

Pause and Resume

See [“Pause/Resume” on page 1236](#) in the section "Common Measurement Functions" for more information.

Trace/Detector

Accesses a menu that allows you to control trace settings.

NOTE Max/Min Hold Traces will be held during the averaging cycle.

Key Path	Front-panel key
Instrument S/W Revision	A.01.60 or later

Max Hold Trace

This key allows you to make the Max Hold Trace visible or invisible in the display..

Remote Command	:DISPlay:PVTime:VIEW[1]:WINDow[1]:TRACe:MAXHold[:STATe] ON OFF 1 0 :DISPlay:PVTime:VIEW[1]:WINDow[1]:TRACe:MAXHold[:STATe] ?
Example	:DISP:PVT:VIEW:WIND:TRAC:MAXH ON :DISP:PVT:VIEW:WIND:TRAC:MAXH?
Key Path	Trace/Detector
Mode	TD-SCDMA
Preset	OFF
State Saved	Saved in instrument state.
Range	On Off
Instrument S/W Revision	A.01.60 or later

Min Hold Trace

This key allows you to make the Min Hold Trace visible or invisible in the display.

Remote Command	:DISPlay:PVTime:VIEW[1]:WINDow[1]:TRACe:MINHold[:STATe] ON OFF 1 0 :DISPlay:PVTime:VIEW[1]:WINDow[1]:TRACe:MINHold[:STATe] ?
Example	:DISP:PVT:VIEW:WIND:TRAC:MINH ON :DISP:PVT:VIEW:WIND:TRAC:MINH?
Key Path	Trace/Detector

Mode	TD-SCDMA
Preset	OFF
State Saved	Saved in instrument state.
Range	On Off
Instrument S/W Revision	A.01.60 or later

Trigger

Selects the trigger source and trigger setup functionality.

Key Path	Front-panel key
Instrument S/W Revision	A.01.60 or later

Trigger Source

Selects a trigger source.

NOTE Trigger Source setup parameters are valid for the current measurement.

Remote Command	:TRIGger:PVTime[:SEquence]:SOURce IMMEDIATE IF VIDeo EXternal[1] EXternal2 RFBurst :TRIGger:PVTime[:SEquence]:SOURce?
Dependencies/Couplings	When Radio Device was set to BTS, the trigger source will become External1, and when Radio Device was set to MS, the trigger source will become RFBurst. If TriggerSource is RFBurst, the Measure Interval will be grayed out.
Example	:TRIG:PVT:SOUR RFB :TRIG:PVT:SOUR?
Key Path	Trigger
Mode	TD-SCDMA
Preset	External1
State Saved	Saved in instrument state.
Range	Free Run Video External 1 External 2 RF Burst
Instrument S/W Revision	A.01.60 or later

Auto Trig

See “Auto Trig” on page 1304 in the section “Common Measurement Functions” for more information.

Trig Holdoff

See “Trig Holdoff” on page 1304 in the section “Common Measurement Functions” for more information.

View/Display

Opens the View menu for the current measurement. The views that are available are specific to the current measurement selected under the Meas key.

All Soft Keys in the “View/Display” menu work regardless of which result window currently has the focus.

For example, the scroll function works on the lower numeric result window even if the upper RF Envelope window currently has the focus.

For more information, see [Power vs Time Measurement Results and Views](#).

Key Path	Front-panel key
Instrument S/W Revision	A.01.60 or later

Power vs Time Measurement Results and Views

This measurement consists of one view, which consists of two windows.

There are two windows:

- [RF Envelope window](#) (upper)
- [Result Metrics window](#) (lower)

Power vs Time Measurement
View/Display

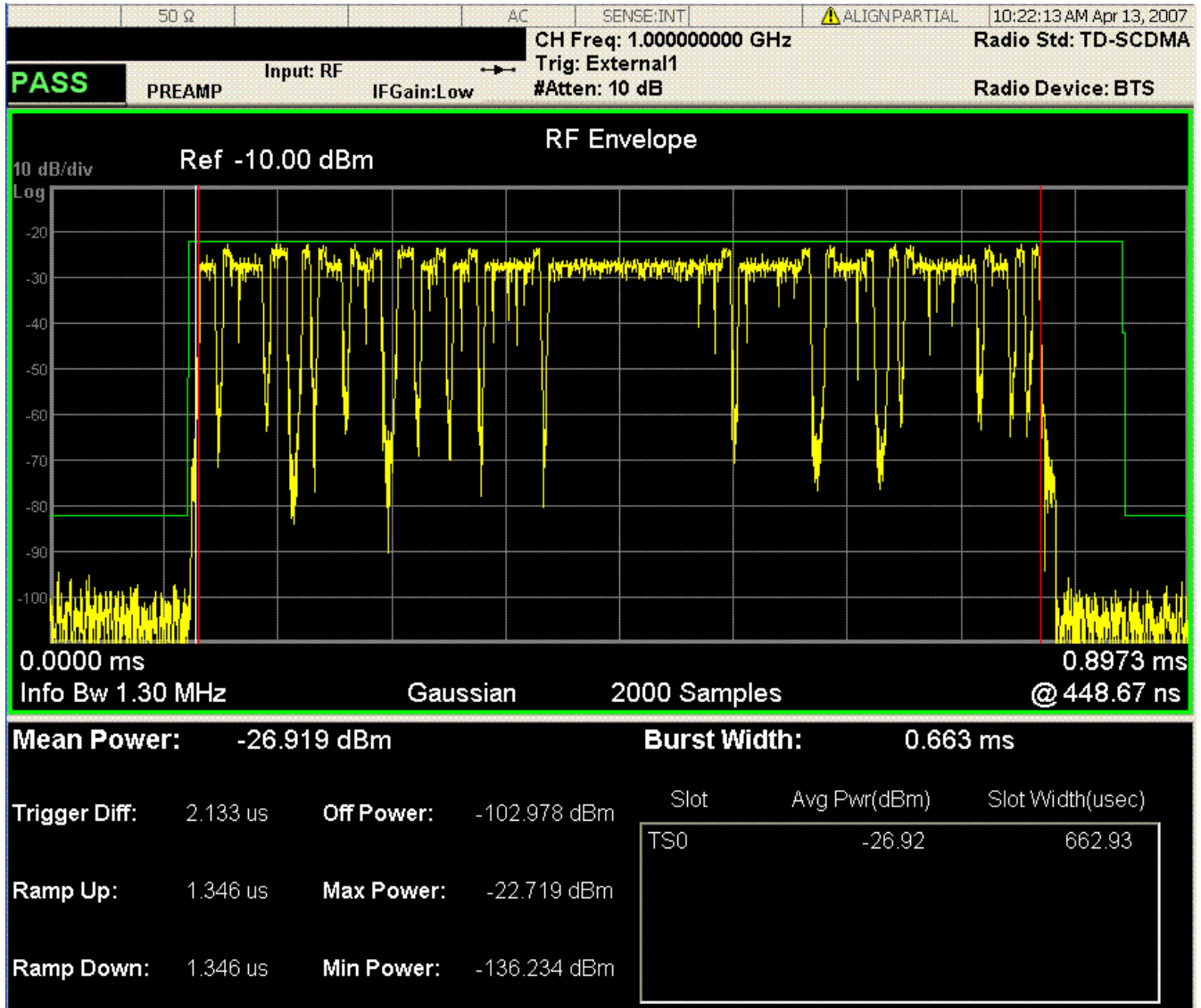

RF Envelope window

This table illustrates the details of RF envelope window:

Marker Operation	Yes
Corresponding Trace	Yellow: Signal wave form, n=2, 3, 4 Green: Limit mask n=5, 6 White: Trigger line Red: Burst lines Blue: Ramp up/down lines

Result Metrics window

This table illustrates the details of metrics window:

Name	Corresponding Results	Display Format
Mean Power	n=1 3rd	99.999 dBm
Burst Width	n=1 4th	99.999 ms
Trigger Diff	n=1 5th	99.999 us
Ramp Up	n=1 6th	99.999 us
Ramp Down	n=1 7th	99.999 us
Off Power	n=1 8th	99.999 dBm
Max Power	n=1 9th	99.999 dBm
Min Power	n=1 10th	99.999 dBm
Slot	N/A	AAA
vg Pwr	n=7	99.99 dBm
Slot width	n=8	99.99 us

NOTE Slot/AvgPwr/SlotWidth section only displays measure results for active slot within display range.

Display

Invokes the Display menu. All measurements have the same Display menu and the same functionality for each key under the Display menu. Refer to [“Display” on page 1307](#) in the "Common Measurement Functions" for more information.

Trigger Lines

Turns the trigger lines On or Off.

Remote Command	:DISPlay:PVTtime:VIEW[1]:WINDow[1]:TRIGger[:STATe] ON OFF 1 0 :DISPlay:PVTtime:VIEW[1]:WINDow[1]:TRIGger[:STATe]?
Example	:DISP:PVT:VIEW:WIND:TRIG ON :DISP:PVT:VIEW:WIND:TRIG?
Key Path	View/Display
Mode	TD-SCDMA
Preset	OFF

Power vs Time Measurement View/Display

State Saved	Saved in instrument state.
Range	On Off
Instrument S/W Revision	A.01.60 or later

Burst Lines

Turns the burst lines On or Off.

Remote Command	<code>:DISPlay:PVTime:VIEW[1]:WINDow[1]:BLINes[:STATe] ON OFF 1 0</code> <code>:DISPlay:PVTime:VIEW[1]:WINDow[1]:BLINes[:STATe]?</code>
Example	<code>:DISP:PVT:VIEW:WIND:BLIN ON</code> <code>:DISP:PVT:VIEW:WIND:BLIN?</code>
Key Path	View/Display
Mode	TD-SCDMA
Preset	OFF
State Saved	Saved in instrument state.
Range	On Off
Instrument S/W Revision	A.01.60 or later

Ramp Lines

Turns the ramp lines On or Off.

Remote Command	<code>:DISPlay:PVTime:VIEW[1]:WINDow[1]:RAMP[:STATe] ON OFF 1 0</code> <code>:DISPlay:PVTime:VIEW[1]:WINDow[1]:RAMP[:STATe]?</code>
Example	<code>:DISP:PVT:VIEW:WIND:RAMP ON</code> <code>:DISP:PVT:VIEW:WIND:RAMP?</code>
Key Path	View/Display
Mode	TD-SCDMA
Preset	OFF
State Saved	Saved in instrument state.
Range	On Off
Instrument S/W Revision	A.01.60 or later

Limit Mask

Turns the limit mask On or Off.

Remote Command	:DISP:PVTime:VIEW[1]:WINDow[1]:LMASk ON OFF 1 0 :DISP:PVTime:VIEW[1]:WINDow[1]:LMASk?
Example	:DISP:PVT:VIEW:WIND:LMAS ON :DISP:PVT:VIEW:WIND:LMAS?
Key Path	View/Display
Mode	TD-SCDMA
Preset	ON
State Saved	Saved in instrument state.
Range	On Off

Scroll

Accesses the Scroll menu, which contains features that enable you to navigate the display.

Key Path	View/Display
Instrument S/W Revision	A.01.60 or later

Prev Page

Moves the display one page back to the previous page of the result metrics window.

Key Path	View/Display, Scroll
Mode	TD-SCDMA
Instrument S/W Revision	A.01.60 or later

Next Page

Moves the display one page forward to the next page of the result metrics window.

Key Path	View/Display, Scroll
Mode	TD-SCDMA
Instrument S/W Revision	A.01.60 or later

Scroll Up

Moves one line upward from the current line of the result metrics window.

Pressing the up arrow hard key has the same effect as this function, if no active function is shown. If an active function is shown, the up arrow hard key controls the active function, but has no effect on line

movement.

Scroll up soft key and up arrow hard key will only effective when Metrics window is focused.

Key Path	View/Display, Scroll
Mode	TD-SCDMA
Instrument S/W Revision	A.01.60 or later

Scroll Down

Moves one line downward from the current line of the result metrics window.

Pressing the down arrow hard key has the same effect as this function, if no active function is shown. If an active function is shown, the up arrow hard key controls the active function, but has no effect on line movement, as the Scroll Down function does.

The scroll down soft key and down arrow hard key are only effective when the Metrics window is focused.

Key Path	View/Display, Scroll
Mode	TD-SCDMA
Instrument S/W Revision	A.01.60 or later

First Page

Moves the display to the first page of the result metrics window.

Key Path	View/Display, Scroll
Mode	TD-SCDMA
Instrument S/W Revision	A.01.60 or later

Last Page

Moves the display to the last page of the result metrics window.

Key Path	View/Display, Scroll
Mode	TD-SCDMA
Instrument S/W Revision	A.01.60 or later

The spectrum emission mask measures spurious signal levels in up to six pairs of offset frequencies and relates them to the carrier power. For measurement results and views, see [“View/Display” on page 568](#).

This topic contains the following sections:

[“Measurement Commands for Spectrum Emission Mask” on page 493](#)

[“Remote Command Results for Spectrum Emission Mask Measurement” on page 493](#)

Measurement Commands for Spectrum Emission Mask

Offsets that are turned off (inactive) will return -999.0 when their results are queried over SCPI.

`:CONFigure:SEMask`

`:CONFigure:SEMask:NDEFault`

`:INITiate:SEMask`

`:FETCh:SEMask[n]?`

`:MEASure:SEMask[n]?`

`:READ:SEMask[n]?`

For more measurement related commands, see the SENSE subsystem, and the section [“Remote Measurement Functions” on page 1127](#).

Remote Command Results for Spectrum Emission Mask Measurement

Command

Return Value

Spectrum Emission Mask Measurement

FETCh:SEMask[n]?	N=1	In case the Meas Type is: Total Power Reference
MEASure:SEMask[n]?		Returns 82 comma-separated scalar results, in the following order:
READ:SEMask[n]?		<ol style="list-style-type: none">1. Reserved for the future use, returns -999.02. Absolute power at the center frequency (reference) area (dBm)3. Reserved for the future use, returns -999.04. Reserved for the future use, returns -999.05. Peak frequency in the center frequency (reference) area (Hz)6. Reserved for the future use, returns -999.07. Reserved for the future use, returns -999.08. Reserved for the future use, returns -999.09. Reserved for the future use, returns -999.010. Reserved for the future use, returns -999.011. Relative integrated power on the negative offset A (dBc)12. Absolute integrated power on the negative offset A (dBm)13. Relative peak power on the negative offset A (dBc)14. Absolute peak power on the negative offset A (dBm)15. Peak power offset frequency from the center frequency in the negative offset A (Hz)16. Relative integrated power on the positive offset A (dBc)17. Absolute integrated power on the positive offset A (dBm)18. Relative peak power on the positive offset A (dBc)19. Absolute peak power on the positive offset A (dBm)20. Peak power offset frequency from the center frequency in the positive offset A (Hz)21. Relative integrated power on the negative offset B (dBc)...69. Absolute peak power on the positive offset F (dBm)70. Peak power offset frequency from the center frequency in the positive offset F (Hz)

- N=1
71. Minimum margin from limit line on the negative offset A (dB)
 72. Minimum margin from limit line on the positive offset A (dB)
 73. Minimum margin from limit line on the negative offset B (dB)
 74. Minimum margin from limit line on the positive offset B (dB)
 75. Minimum margin from limit line on the negative offset C (dB)
 76. Minimum margin from limit line on the positive offset C (dB)
 77. Minimum margin from limit line on the negative offset D (dB)
 78. Minimum margin from limit line on the positive offset D (dB)
 79. Minimum margin from limit line on the negative offset E (dB)
 80. Minimum margin from limit line on the positive offset E (dB)
 81. Minimum margin from limit line on the negative offset F (dB)
 82. Minimum margin from limit line on the positive offset F (dB)

- N=1 In case the Meas Type is: Power Spectral Density Reference
- Returns 82 comma-separated scalar results, in the following order:
1. Reserved for the future use, returns -999.0
 2. Absolute power at the center frequency (reference) area (dBm)
 3. Reserved for the future use, returns -999.0
 4. Reserved for the future use, returns -999.0
 5. Peak frequency in the center frequency (reference) area (Hz)
 6. Reserved for the future use, returns -999.0
 7. Reserved for the future use, returns -999.0
 8. Reserved for the future use, returns -999.0
 9. Reserved for the future use, returns -999.0
 10. Reserved for the future use, returns -999.0
 11. Relative integrated power on the negative offset A (dB).
 12. Absolute integrated power on the negative offset A (dBm/Hz).
 13. Relative peak power on the negative offset A (dB)
 14. Absolute peak power on the negative offset A (dBm/Hz)
 15. Peak power offset frequency from the center frequency in the negative offset A (Hz)
 16. Relative integrated power on the positive offset A (dB).
 17. Absolute integrated power on the positive offset A (dBm/Hz).
 18. Relative peak power on the positive offset A (dB)
 19. Absolute peak power on the positive offset A (dBm/Hz)
 20. Peak power offset frequency from the center frequency in the positive offset A (Hz)
 21. Relative integrated power on the negative offset B (dB).
 - ...
 69. Absolute peak power on the positive offset F (dBm/Hz)
 70. Peak power offset frequency from the center frequency in the positive offset F (Hz)

- N=1
71. Minimum margin from limit line on the negative offset A (dB)
 72. Minimum margin from limit line on the positive offset A (dB)
 73. Minimum margin from limit line on the negative offset B (dB)
 74. Minimum margin from limit line on the positive offset B (dB)
 75. Minimum margin from limit line on the negative offset C (dB)
 76. Minimum margin from limit line on the positive offset C (dB)
 77. Minimum margin from limit line on the negative offset D (dB)
 78. Minimum margin from limit line on the positive offset D (dB)
 79. Minimum margin from limit line on the negative offset E (dB)
 80. Minimum margin from limit line on the positive offset E (dB)
 81. Minimum margin from limit line on the negative offset F (dB)
 82. Minimum margin from limit line on the positive offset F (dB)

- N=1 In case the Meas Type is: Spectrum Peak Reference
- Returns 82 comma-separated scalar results, in the following order:
1. Reserved for the future use, returns –999.0
 2. Peak power at the center frequency (reference) area (dBm)
 3. Reserved for the future use, returns –999.0
 4. Reserved for the future use, returns –999.0
 5. Peak frequency in the center frequency (reference) area (Hz)
 6. Reserved for the future use, returns –999.0
 7. Reserved for the future use, returns –999.0
 8. Reserved for the future use, returns –999.0
 9. Reserved for the future use, returns –999.0
 10. Reserved for the future use, returns –999.0
 11. Reserved for the future use, returns –999.0
 12. Reserved for the future use, returns –999.0
 13. Relative peak power on the negative offset A (dB)
 14. Absolute peak power on the negative offset A (dBm)
 15. Peak power offset frequency from the center frequency in the negative offset A (Hz)
 16. Reserved for the future use, returns –999.0
 17. Reserved for the future use, returns –999.0
 18. Relative peak power on the positive offset A (dB)
 19. Absolute peak power on the positive offset A (dBm)
 20. Peak power offset frequency from the center frequency in the positive offset A (Hz)
 21. Reserved for the future use, returns –999.0
 - ...
 69. Absolute peak power on the positive offset F (dBm)
 70. Peak power offset frequency from the center frequency in the positive offset F (Hz)

- N=1
- 71. Minimum margin from limit line on the negative offset A (dB)
 - 72. Minimum margin from limit line on the positive offset A (dB)
 - 73. Minimum margin from limit line on the negative offset B (dB)
 - 74. Minimum margin from limit line on the positive offset B (dB)
 - 75. Minimum margin from limit line on the negative offset C (dB)
 - 76. Minimum margin from limit line on the positive offset C (dB)
 - 77. Minimum margin from limit line on the negative offset D (dB)
 - 78. Minimum margin from limit line on the positive offset D (dB)
 - 79. Minimum margin from limit line on the negative offset E (dB)
 - 80. Minimum margin from limit line on the positive offset E (dB)
 - 81. Minimum margin from limit line on the negative offset F (dB)
 - 82. Minimum margin from limit line on the positive offset F (dB)
- N=2
- Returns the displayed frequency domain spectrum trace data separated by comma. The number of data is 2001.
- N=3
- Returns the displayed frequency domain absolute limit trace data separated by comma. The number of data is determined 2001.
- N=4
- Returns the displayed frequency domain relative limit trace data separated by comma. The number of data is 2001.
- N=5
- In case the Meas Type is: Total Power Reference
- Returns 14 comma-separated scalar values (in dBm) of the absolute integrated power of the segment frequencies:
- 1. Total power reference (dBm)
 - 2. Reserved for the future use, returns -999.0
 - 3. Absolute integrated power at negative offset frequency (A)
 - 4. Absolute integrated power at positive offset frequency (A)
 - ...
 - 13. Absolute integrated power at negative offset frequency (F)
 - 14. Absolute integrated power at positive offset frequency (F)

- N=5 In case the Meas Type is: Power Spectral Density Reference
- Returns 14 comma-separated scalar values (in dBm/Hz) of the absolute integrated power of the segment frequencies. Returns -999.0 for the offsets if in WLAN:
1. Power spectral density reference (dBm/Hz)
 2. Reserved for the future use, returns -999.0
 3. Absolute integrated power at negative offset frequency (A)
 4. Absolute integrated power at positive offset frequency (A)
 - ...
 13. Absolute integrated power at negative offset frequency (F)
 14. Absolute integrated power at positive offset frequency (F)
- N=5 In case the Meas Type is: Spectrum Peak Reference
- Returns 14 comma-separated scalar values (in dBm) of the absolute peak power of the segment frequencies.
1. Spectrum Peak Power reference (dBm)
 2. Reserved for the future use, returns -999.0
 3. Absolute peak power at negative offset frequency (A)
 4. Absolute peak power at positive offset frequency (A)
 - ...
 13. Absolute peak power at negative offset frequency (F)
 14. Absolute peak power at positive offset frequency (F)
- N=6 In case the Meas Type is: Total Power Reference
- Returns 14 comma-separated scalar values (in dBc) of the integrated power relative to the carrier at the segment frequencies:
1. Reserved for the future use, returns -999.0
 2. Reserved for the future use, returns -999.0
 3. Relative integrated power at negative offset frequency (A)
 4. Relative integrated power at positive offset frequency (A)
 - ...
 13. Relative integrated power at negative offset frequency (F)
 14. Relative integrated power at positive offset frequency (F)

- N=6 In case the Meas Type is: Power Spectral Density Reference
- Returns 14 comma-separated scalar values (in dBc/Hz) of the integrated power relative to the carrier at the segment frequencies. Returns -999.0 for the offsets if in WLAN:
1. Reserved for the future use, returns -999.0
 2. Reserved for the future use, returns -999.0
 3. Relative integrated power at negative offset frequency (A)
 4. Relative integrated power at positive offset frequency (A)
 - ...
 13. Relative integrated power at negative offset frequency (F)
 14. Relative integrated power at positive offset frequency (F)
- N=6 In case the Meas Type is: Spectrum Peak Reference
- Returns 14 comma-separated scalar values (in dB) of the integrated power relative to the carrier at the segment frequencies.
1. Reserved for the future use, returns -999.0
 2. Reserved for the future use, returns -999.0
 3. Relative peak power at negative offset frequency (A)
 4. Relative peak power at positive offset frequency (A)
 - ...
 13. Relative peak power at negative offset frequency (F)
 14. Relative peak power at positive offset frequency (F)
- N=7 Returns 14 comma-separated pass/fail test results (0=passed, or 1=failed) determined by testing the minimum margin point from the limit line that is determined each offset's Limits setting.
1. Reserved for the future use, returns -999.0
 2. Reserved for the future use, returns -999.0
 3. At negative offset frequency (A)
 4. At positive offset frequency (A)
 - ...
 13. At negative offset frequency (F)
 14. At positive offset frequency (F)

N=8 Returns 14 comma-separated pass/fail test results (0=passed, or 1=failed) determined by testing the minimum margin point from the limit line that is determined each offset's Limits setting.

Note: This results (N=8) are the same as N=7 result.

1. Reserved for the future use, returns -999.0
2. Reserved for the future use, returns -999.0
3. At negative offset frequency (A)
4. At positive offset frequency (A)

...

13. At negative offset frequency (F)
14. At positive offset frequency (F)

N=9 Returns 14 comma-separated scalar values of frequency (in Hz) that have peak power in each offset:

1. Reserved for the future use, returns -999.0
2. Reserved for the future use, returns -999.0
3. Negative offset frequency (A)
4. Positive offset frequency (A)

...

13. Negative offset frequency (F)
14. Positive offset frequency (F)

N=10 Returns 14 comma-separated scalar values (in dBm) of the absolute peak power of the segment frequencies:

1. Reserved for the future use, returns -999.0
2. Reserved for the future use, returns -999.0
3. At negative offset frequency (A)
4. At positive offset frequency (A)

...

13. At negative offset frequency (F)
14. At positive offset frequency (F)

- N=11 Returns 14 comma-separated scalar values in dBc (dB if MeasType = PSD) of the peak power relative to the carrier at the segment frequencies:
1. Reserved for the future use, returns -999.0
 2. Reserved for the future use, returns -999.0
 3. At negative offset frequency (A)
 4. At positive offset frequency (A)
 - ...
 13. At negative offset frequency (F)
 14. At positive offset frequency (F)
- N=12 Returns the power result (the peak power of the signal in the ref channel) when Meas Type is Spectrum Peak reference. Otherwise, the value returned will be -999.0

Key Path

Meas

Instrument S/W Revision

Prior to A.02.00

AMPTD Y Scale

Accesses a menu of functions that enable you to set the vertical scale parameters. The parameter values are measurement independent except all Attenuation values and Internal Preamp selections that are measurement global.

Key Path	Front-panel key
Instrument S/W Revision	Prior to A.02.00

Ref Value

Sets the value for the absolute power reference. However, since the Auto Scaling is defaulted to On, this value is automatically determined by the measurement result. When you set a value manually, Auto Scaling automatically changes to Off.

Remote Command	<code>:DISPlay:SEMask:VIEW[1]:WINDow[1]:TRACe:Y[:SCALE]:RLEVe l <real></code> <code>:DISPlay:SEMask:VIEW[1]:WINDow[1]:TRACe:Y[:SCALE]:RLEVe l?</code>
Example	<code>DISP:SEM:VIEW:WIND:TRAC:Y:RLEV 100</code> <code>DISP:SEM:VIEW:WIND:TRAC:Y:RLEV?</code>
Dependencies/Couplings	When the Auto Scaling is On, this value is automatically determined by the measurement result. When you set a value manually, Auto Scaling automatically changed to Off.
Key Path	AMPTD Y Scale
Mode	SA, WCDMA, C2K, WIMAX OFDMA, TD-SCDMA, 1xEVDO, DTMB, DVB-T/H
Notes	You must be in the Spectrum Analysis mode, W-CDMA mode, cdma2000 mode, TD-SCDMA mode, DTMB mode, DVB-T/H mode, 1xEVDO mode or WIMAX OFDMA mode to use this command. Use :INSTrument:SElect to set the mode.
Preset	All except CDMA1xEVDO:10.0 dBm CDMA1xEVDO: -10.0dBm
State Saved	Saved in instrument state.
Min	-250 dBm
Max	250 dBm
Instrument S/W Revision	Prior to A.02.00

Attenuation

Accesses a menu of functions that enable you to change attenuation settings. This key has read-back text that describes the total attenuator value.

See AMPTD Y Scale, “[Attenuation](#)” on page 1037 in the “Analyzer Setup Functions” section for more information.

Key Path	AMPTD Y Scale, Attenuation
Instrument S/W Revision	Prior to A.02.00

Scale/Div

Sets the units-per-division of the vertical scale in the logarithmic display. When Auto Scaling is On, the scale per division value is automatically determined by the measurement result. When you set a value manually, Auto Scaling automatically changes to Off.

Remote Command	:DISPlay:SEMask:VIEW[1]:WINDow[1]:TRACe:Y[:SCALe]:PDIVi sion <rel_ampl> :DISPlay:SEMask:VIEW[1]:WINDow[1]:TRACe:Y[:SCALe]:PDIVi sion?
Example	DISP:SEM:VIEW:WIND:TRAC:Y:PDIV 15dB DISP:SEM:VIEW:WIND:TRAC:Y:PDIV?
Dependencies/Couplings	When the Auto Scaling is On, this value is automatically determined by the measurement result. When you set a value manually, Auto Scaling automatically changes to Off.
Key Path	AMPTD Y Scale
Mode	SA, WCDMA, C2K, WIMAX OFDMA, TD-SCDMA, 1xEVDO, DTMB, DVB-T/H
Notes	You must be in the Spectrum Analysis mode, W-CDMA mode, cdma2000 mode, TD-SCDMA mode, DTMB mode, DVB-T/H mode, 1xEVDO mode or WIMAX OFDMA mode to use this command. Use :INSTrument:SElect to set the mode.
Preset	10 dB
State Saved	Saved in instrument state.
Min	0.10 dB
Max	20.00 dB
Instrument S/W Revision	Prior to A.02.00

Presel Center

See AMPTD Y Scale, “[Presel Center](#)” on page 1049 in the “Common Measurement Functions” section

for more information.

Presel Adjust

See AMPTD Y Scale, “[Preselector Adjust](#)” on page 1050 in the “Common Measurement Functions” section for more information.

Internal Preamp

Accesses a menu of functions that enable you to control the internal preamplifiers.

See AMPTD Y Scale, “[Internal Preamp](#)” on page 1052 in the “Analyzer Setup Functions” section for more information.

Ref Position

Positions the reference level at the top, center or bottom of the Y scale display. Changing the reference position does not affect the reference level value.

Remote Command	:DISPlay:SEMask:VIEW[1]:WINDow[1]:TRACe:Y[:SCALe]:RPOSi tion TOP CENTer BOTTom :DISPlay:SEMask:VIEW[1]:WINDow[1]:TRACe:Y[:SCALe]:RPOSi tion?
Example	DISP:SEM:VIEW:WIND:TRAC:Y:RPOS BOTT DISP:SEM:VIEW:WIND:TRAC:Y:RPOS?
Key Path	AMPTD Y Scale
Mode	SA, WCDMA, C2K, WIMAX OFDMA, TD-SCDMA, 1xEVDO, DTMB, DVB-T/H
Notes	You must be in the Spectrum Analysis mode, W-CDMA mode, cdma2000 mode, TD-SCDMA mode, DTMB mode, DVB-T/H mode, 1xEVDO mode or WIMAX OFDMA mode to use this command. Use INSTRument:SElect to set the mode.
Preset	TOP
State Saved	Saved in instrument state.
Range	Top Ctr Bot
Instrument S/W Revision	Prior to A.02.00

Auto Scaling

Toggles the Auto Scaling function between On and Off.

When Auto Scaling is On and the Restart front-panel key is pressed, the analyzer automatically determines the scale per division and reference values based on the measurement results. When you set a

value to either Scale/Div or Ref Value manually, Auto Scaling automatically changes to Off.

Remote Command	<pre>:DISPlay:SEMask:VIEW[1]:WINDow[1]:TRACe:Y[:SCALe]:COUPl e 0 1 ON OFF :DISPlay:SEMask:VIEW[1]:WINDow[1]:TRACe:Y[:SCALe]:COUPl e?</pre>
Example	<pre>DISP:SEM:VIEW:WIND:TRAC:Y:COUP OFF DISP:SEM:VIEW:WIND:TRAC:Y:COUP?</pre>
Dependencies/Couplings	<p>When Auto Scaling is On, upon pressing the Restart front-panel key, this function automatically determines the scale per division and reference values based on the measurement results.</p> <p>When you set a value to either Scale/Div or Ref Value manually, Auto Scaling automatically changes to Off.</p>
Key Path	AMPTD Y Scale
Mode	SA, WCDMA, C2K, WIMAX OFDMA, TD-SCDMA, 1xEVDO, DTMB, DVB-T/H
Notes	You must be in the Spectrum Analysis mode, W-CDMA mode, cdma2000 mode, TD-SCDMA, DTMB mode, DVB-T/H mode, 1xEVDO mode or WIMAX OFDMA mode to use this command. Use :INSTrument:SElect to set the mode.
Preset	ON
State Saved	Saved in instrument state.
Range	On Off
Instrument S/W Revision	Prior to A.02.00

Auto Couple

See “**AUTO COUPLE**” on page 1055 in the section “Common Measurement Functions” for more information.

BW

This key is unavailable for this measurement. The BW key will display a blank key menu when pressed.

Key Path	Front-panel key
Instrument S/W Revision	Prior to A.02.00

Cont

See “[Cont \(Continuous Measurement/Sweep\)](#)” on page 1059 in the section "Common Measurement Functions" for more information.

FREQ Channel

See “Frequency/Channel” on page 1061 in the section "Common Measurement Functions" for more information.

Input/Output

See “[Input/Output](#)” on page 1065 in the section "Common Measurement Functions" for more information.

Marker

Accesses a menu that enables you to select, set up and control the markers for the current measurement. If there are no active markers, **Marker** selects marker 1, sets it to Normal and places it at the center of the display. You can turn on and control up to 12 markers.

Key Path	Front-panel key
Instrument S/W Revision	Prior to A.02.00

Select Marker

Displays 12 markers available for selection.

Key Path	Marker
Instrument S/W Revision	Prior to A.02.00

Marker Type

Sets the marker control mode to Normal and Off. If the selected marker is Off, pressing Marker sets it to Normal and places it at the center of the screen on the trace determined by the **Marker Trace** rules. At the same time, **Marker X Axis Value** appears on the Active Function area. The marker X axis value entered in the active function area will display the marker value to its full entered precision. If the current control mode for the measurement is Off, there is no active function and the active function is turned off.

Remote Command	:CALCulate:SEMask:MARKer[1] 2 3 4 5 6 7 8 9 10 11 12:MODE POSITION OFF :CALCulate:SEMask:MARKer[1] 2 3 4 5 6 7 8 9 10 11 12:MODE?
Example	CALC:SEM:MARK:MODE POS CALC:SEM:MARK:MODE?
Key Path	Marker
Mode	SA, WCDMA, C2K, WIMAX OFDMA, TD-SCDMA, 1xEVDO, DTMB, DVB-T/H
Notes	If the selected marker is Off, pressing Marker sets it to Normal and places it at the center of the screen on the trace determined by the Marker Trace rules. At the same time, Marker X Axis Value appears on the Active Function area. Default Active Function: the active function for the selected marker's current control mode. Note that if the current control mode is Off, there is no active function and the active function is turned off. Active Function Display: the marker X axis value entered in the active function area will display the marker value to its full entered precision.

Spectrum Emission Mask Measurement Marker

Preset	OFF OFF OFF OFF OFF OFF OFF OFF OFF OFF OFF OFF
State Saved	Saved in instrument state.
Range	Normal Off
Instrument S/W Revision	Prior to A.02.00

Marker X Axis Value (Remote Command only)

Sets the marker X Axis value in the current marker X Axis Scale unit. It has no effect if the control mode is Off, but is the SCPI equivalent of entering an X value if the control mode is **Normal**.

Remote Command	:CALCulate:SEMask:MARKer[1] 2 3 4 5 6 7 8 9 10 11 12:X <freq> :CALCulate:SEMask:MARKer[1] 2 3 4 5 6 7 8 9 10 11 12:X?
Example	CALC:SEM:MARK3:X 1.0 GHz CALC:SEM:MARK3:X?
Mode	SA, WCDMA, C2K, WIMAX OFDMA, TD-SCDMA, 1xEVDO, DTMB, DVB-T/H
Notes	If no suffix is sent it will use the fundamental units for the current marker X Axis Scale. If a suffix is sent that does not match the current marker X Axis Scale unit, an error "Invalid suffix" will be generated. The query returns the marker's absolute X Axis value if the control mode is Normal . The query is returned in the fundamental units for the current marker X Axis scale. If the marker is Off the response is not a number. When a Marker is turned on, it is placed center of the screen on the trace. Therefore the default value depends on instrument condition, although the Preset/Default is defined as 1.5 GHz.
Preset	After a preset, all Markers are turned OFF, so Marker X Axis Value query will return a not a number (NAN).
State Saved	No
Min	-9.9E+37
Max	9.9E+37
Instrument S/W Revision	Prior to A.02.00

Marker X Axis Position (Remote Command only)

Sets the marker X position in trace points. It has no effect if the control mode is **Off**, but is the SCPI equivalent of entering a value if the control mode is **Normal**, except in trace points rather than X Axis Scale units. The entered value is immediately translated into the current X Axis Scale units for setting

the value of the marker.

Remote Command	:CALCulate:SEMask:MARKer[1] 2 3 4 5 6 7 8 9 10 11 12:X:POSition <real> :CALCulate:SEMask:MARKer[1] 2 3 4 5 6 7 8 9 10 11 12:X:POSition?
Example	CALC:SEM:MARK10:X:POS 1001 CALC:SEM:MARK10:X:POS?
Mode	SA, WCDMA, C2K, WIMAX OFDMA, TD-SCDMA, 1xEVDO, DTMB, DVB-T/H
Notes	The query returns the marker's absolute X Axis value in trace points if the control mode is Normal . The value is returned as a real number, not an integer, corresponding to the translation from X Axis Scale units to trace points . If the marker is Off the response is not a number. When a Marker is turned on, it is placed center of the screen on the trace. Therefore the default value depends on he instrument condition although the Preset/Default is defined as 6507 (this value might be the expected value when all the offsets are on).
Preset	After a preset, all Markers are turned OFF, so Marker X Axis Value query will return a not a number (NAN).
State Saved	No
Min	-9.9E+37
Max	9.9E+37
Instrument S/W Revision	Prior to A.02.00

Marker Y Axis Value (Remote Command only)

Returns the marker Y Axis value in the current marker Y Axis unit.

Remote Command	:CALCulate:SEMask:MARKer[1] 2 3 4 5 6 7 8 9 10 11 12:Y?
Example	CALC:SEM:MARK11:Y 10 dBm CALC:SEM:MARK11:Y?
Mode	SA, WCDMA, C2K, WIMAX OFDMA, TD-SCDMA, 1xEVDO, DTMB, DVB-T/H
Notes	Since the result value is always calculated from acquisition data, the default value is arbitrary, although the Preset/Default values is defined.
Preset	Result dependent on markers setup and signal source
State Saved	No

Instrument S/W Revision Prior to A.02.00

Couple Markers

When this function is true, moving any marker causes an equal X Axis movement of every other marker which is not **Off**. By “equal X Axis movement” we mean that we preserve the difference between each marker’s X Axis value (in the fundamental x-axis units of the trace that marker is on) and the X Axis value of the marker being moved (in the same fundamental x-axis units).

Remote Command :CALCulate:SEMask:MARKer:COUple[:STATe] ON|OFF|1|0
 :CALCulate:SEMask:MARKer:COUple[:STATe]?

Example CALC:SEM:MARK:COUP ON
 CALC:SEM:MARK:COUP?

Key Path **Marker**

Mode SA, WCDMA, C2K, WIMAX OFDMA, TD-SCDMA, 1xEVDO, DTMB, DVB-T/H

Preset OFF

State Saved Saved in instrument state.

Range On|Off

Instrument S/W Revision Prior to A.02.00

All Markers Off

Turns all active markers off in all views.

Remote Command :CALCulate:SEMask:MARKer:AOFF

Example CALC:SEM:MARK:AOFF

Key Path **Marker**

Mode SA, WCDMA, C2K, WIMAX OFDMA, TD-SCDMA, 1xEVDO, DTMB, DVB-T/H

Instrument S/W Revision Prior to A.02.00

Marker Function

There are no 'Marker Functions' supported in Spectrum Emission Mask so this front-panel key will display a blank menu key when pressed.

Key Path	Front-panel key
Instrument S/W Revision	Prior to A.02.00

Marker To

There is no 'Marker To' functionality supported in Spectrum Emission Mask so this front-panel key will display a blank menu key when pressed.

Key Path	Front-panel key
Instrument S/W Revision	Prior to A.02.00

Meas

See “[Meas](#)” on page 1127 in the section "Common Measurement Functions" for more information.

Meas Setup

Displays the setup menu for the currently selected measurement.

Key Path	Front-panel key
Instrument S/W Revision	Prior to A.02.00

Avg/Hold Num

Toggles averaging On or Off in addition to enabling you to set the number of measurement averages used to calculate the measurement result. The average will be displayed at the end of each sweep. After the specified number of average counts, the average mode (termination control) setting determines the average action.

In the remote mode, use the Average State command to turn averaging on or off.

Remote Command	<code>[:SENSe] :SEMAsk :AVERAge :COUNt <integer></code> <code>[:SENSe] :SEMAsk :AVERAge :COUNt ?</code> <code>[:SENSe] :SEMAsk :AVERAge [:STATe] ON OFF 1 0</code> <code>[:SENSe] :SEMAsk :AVERAge [:STATe] ?</code>
-----------------------	---

Example	<code>SEM:AVER:COUN 100</code> <code>SEM:AVER:COUN?</code> <code>SEM:AVER ON</code> <code>SEM:AVER?</code>
---------	---

Key Path	Meas Setup
Mode	SA, WCDMA, C2K, WIMAX OFDMA, TD-SCDMA, 1xEVDO, DTMB, DVB-T/H
Notes	You must be in the Spectrum Analysis mode, W-CDMA mode, cdma2000 mode, TD-SCDMA mode, DTMB mode, DVB-T/H mode, 1xEVDO mode or WIMAX OFDMA mode to use this command. Use :INSTrument:SELEct to set the mode.
Preset	10 OFF
State Saved	Saved in instrument state.
Min	1
Max	10000
Instrument S/W Revision	Prior to A.02.00

Meas Type

Accesses a menu that enables you to select one of the following measurement reference types:

Total Pwr Ref – Sets the reference to the total carrier power and the measured data is shown in dBc and dBm.

PSD Ref – Sets the reference to the mean power spectral density of the carrier and the measured data is shown in dB and dBm/Hz.

Spectrum Peak Ref – Sets the reference to the spectrum peak power of the carrier and the measured data is shown in dB and dBm.

Remote Command	[:SENSE] : SEMask : TYPE PSDRef TPreRef SPRef [:SENSE] : SEMask : TYPE ?
Example	SEM:TYPE PSDR SEM:TYPE?
Key Path	Meas Setup
Mode	SA, WCDMA, C2K, WIMAX OFDMA, TD-SCDMA, 1xEVDO, DTMB DVB-T/H
Notes	You must be in the Spectrum Analysis mode, W-CDMA mode, cdma2000 mode, TD-SCDMA mode, DTMB mode, DVB-T/H mode, 1xEVDO mode or WIMAX OFDMA mode to use this command. Use :INSTrument:SElect to set the mode.
Preset	SA, WCDMA, C2K, TD-SCDMA, 1xEVDO, DTMB, DVB-T/H: TPreRef WIMAX OFDMA: SPRef
State Saved	Saved in instrument state.
Range	Total Pwr Ref PSD Ref Spectrum Peak Ref
Instrument S/W Revision	Prior to A.02.00

Ref Channel

Accesses a menu that enables you to set up the measurement parameters used to calculate the power in the reference channel.

Key Path	Meas Setup
Instrument S/W Revision	Prior to A.02.00

Integ BW

Specifies the integration bandwidth used to calculate the power in the reference channel.

Remote Command	[:SENSE] : SEMask : BANDwidth[1] 2: INTEgration <bandwidth> [:SENSE] : SEMask : BANDwidth[1] 2: INTEgration?
-----------------------	---

Spectrum Emission Mask Measurement Meas Setup

Example	SEM:BAND:INT 10 MHz SEM:BAND:INT?
Dependencies/Couplings	Cannot be higher than the channel Span. If lower than 1/10 of channel Span, then the channel Span is reduced to be 10 times the Integ BW.
Key Path	Meas Setup, Ref Chan
Mode	SA, WCDMA, C2K, WIMAX OFDMA, TD-SCDMA, 1xEVDO, DTMB, DVB-T/H
Notes	10% . 100% of Channel Span Parameter Value Bandwidth sub op code, 1 is for BTS, 2 for MS. Default is BTS. You must be in the Spectrum Analysis mode, W-CDMA mode or cdma2000 mode, TD-SCDMA mode, DTMB mode, DVB-T/H mode, 1xEVDO mode or WIMAX OFDMA mode to use this command. Use :INSTrument:SElect to set the mode.
Preset	SA: 3.84 MHz WCDMA: 3.84 MHz 3.84 MHz C2K: 1.23 MHz 1.23 MHz WIMAX OFDMA: 10 MHz 10 MHz TD-SCDMA: 1.28 MHz 1.28 MHz 1xEVDO: 1.23MHz DTMB: 7.56MHz DVB-T/H: 7.61MHz
State Saved	Saved in instrument state.
Min	100.0 kHz
Max	50 MHz
Instrument S/W Revision	Prior to A.02.00

Span

Specifies the span used to calculate the power in the reference channel.

Remote Command	[:SENSE] :SEMAsk:FREQuency[1] 2 :SPAN <freq> [:SENSE] :SEMAsk:FREQuency[1] 2 :SPAN?
Example	SEM:FREQ:SPAN 3MHz SEM:FREQ:SPAN?
Dependencies/Couplings	Range 1 kHz to 50 MHz (although restricted by Integ BW). If you set the channel Span lower than channel Integ BW, they will both track each other. As you increase the channel Span, the Integ BW will also increase if it is less than 1/10 of the channel Span.

Key Path	Meas Setup, Ref Chan
Mode	SA, WCDMA, C2K, WIMAX OFDMA, TD-SCDMA, 1xEVDO, DTMB, DVB-T/H
Notes	Frequency sub op code, 1 is for BTS, 2 for MS. Default is BTS. You must be in the Spectrum Analysis mode, W-CDMA mode, cdma2000 mode, TD-SCDMA mode, DTMB mode, DVB-T/H mode, 1xEVDO mode or WIMAX OFDMA mode to use this command. Use :INSTrument:SElect to set the mode.
Preset	SA: 5.0 MHz WCDMA: 5.0 MHz 5.0 MHz C2K: 1.25 MHz 1.25 MHz WIMAX OFDMA: 10 MHz 10 MHz TD-SCDMA: 1.6 MHz 1.6 MHz 1xEVDO: 1.25MHz DTMB: 10MHz DVB-T/H: 10MHz
State Saved	Saved in instrument state.
Min	1 kHz
Max	50 MHz
Instrument S/W Revision	Prior to A.02.00

Sweep Time

Sets the sweep time used to calculate the power in the reference channel. Sweep Time can be set manually or put in auto mode.

Remote Command	[:SENSE] :SEMAsk :SWEep [1] 2 :TIME <time> [:SENSE] :SEMAsk :SWEep [1] 2 :TIME? [:SENSE] :SEMAsk :SWEep [1] 2 :TIME :AUTO OFF 0 ON 1 [:SENSE] :SEMAsk :SWEep [1] 2 :TIME :AUTO?
-----------------------	--

Example	SEM:SWE:TIME 9ms SEM:SWE:TIME? SEM:SWE:TIME:AUTO OFF SEM:SWE:TIME:AUTO?
---------	--

Dependencies/Couplings	When the Sweep Time is set manually, Auto is set to OFF. Value is coupled with Channel Detector selection, Channel Resolution BW, Channel Video BW if the state is Auto. When set to Auto, the Sweep Time is automatically calculated
------------------------	---

Spectrum Emission Mask Measurement Meas Setup

Key Path	Meas Setup, Ref Chan
Mode	SA, WCDMA, C2K, WIMAX OFDMA, TD-SCDMA, 1xEVDO, DTMB, DVB-T/H
Notes	Sweep Time sub op code, 1 is for BTS, 2 for MS. Default is BTS. You must be in the Spectrum Analysis mode, W-CDMA mode, cdma2000 mode, TD-SCDMA mode, DTMB mode, DVB-T/H mode, 1xEVDO mode or WIMAX OFDMA mode to use this command. Use :INSTrument:SElect to set the mode.
Preset	Automatically calculated ON
State Saved	Saved in instrument state.
Min	1 ms
Max	10 s
Instrument S/W Revision	Prior to A.02.00

Res BW

Sets the resolution bandwidth used to calculate the power in the reference channel. The Channel Resolution BW can be set manually or put in to auto mode.

Remote Command	<pre>[:SENSe]:SEMAsk:BA NDwidth[1] 2[:RESolution] <bandwidth> [:SENSe]:SEMAsk:BA NDwidth[1] 2[:RESolution]? [:SENSe]:SEMAsk:BA NDwidth[1] 2[:RESolution]:AUTO OFF ON 1 0 [:SENSe]:SEMAsk:BA NDwidth[1] 2[:RESolution]:AUTO?</pre>
Example	<pre>SEM:BA ND 100 kHz SEM:BA ND? SEM:BA ND:AUTO ON SEM:BA ND:AUTO?</pre>
Dependencies/Couplings	<p>When Res BW is set manually, Channel Resolution BW Mode is set to MANual.</p> <p>Value is coupled with Channel Detector selection, Channel Sweep Time, Channel Video BW.</p> <p>When set to Auto, the resolution bandwidth is automatically calculated.</p>
Key Path	Meas Setup, Ref Chan
Mode	SA, WCDMA, C2K, WIMAX OFDMA, TD-SCDMA, 1xEVDO, DTMB, DVB-T/H

Notes	Bandwidth sub op code, 1 is for BTS, 2 for MS. Default is BTS. You must be in the Spectrum Analysis mode, W-CDMA mode, cdma2000 mode, TD-SCDMA mode, DTMB mode, DVB-T/H mode, 1xEVDO mode or WIMAX OFDMA mode to use this command. Use :INSTRUMENT:SELEct to set the mode.
Preset	SA: 100 kHz WCDMA: 75 kHz C2K: 24 kHz WIMAX OFDMA: 100 kHz TD-SCDMA: 30 kHz 1xEVDO: 30.0KHz DTMB: 3.9kHz DVB-T/H: 3.9kHz OFF
State Saved	Saved in instrument state.
Min	1 Hz
Max	8 MHz
Instrument S/W Revision	Prior to A.02.00

Video BW

Sets the video bandwidth used to calculate the power in the reference channel. The Channel Video BW can be set manually or put in to auto mode.

Remote Command

```
[ :SENSE]:SEMAsk:BANDwidth[1] | 2:VIDeo <bandwidth>
[ :SENSE]:SEMAsk:BANDwidth[1] | 2:VIDeo?
[ :SENSE]:SEMAsk:BANDwidth[1] | 2:VIDeo:AUTO OFF | ON | 1 | 0
[ :SENSE]:SEMAsk:BANDwidth[1] | 2:VIDeo:AUTO?
```

Example

```
SEM:BAND:VID 100 kHz
SEM:BAND:VID?
SEM:BAND:VID:AUTO ON
SEM:BAND:VID:AUTO?
```

Dependencies/Couplings

When Video BW is set manually, Channel Video BW Mode is set to MANUal
Value is coupled with Channel Detector selection, Channel Sweep Time, Channel Resolution BW.

When set to Auto, the video bandwidth is automatically calculated.

Key Path **Meas Setup, Ref Chan**

Spectrum Emission Mask Measurement Meas Setup

Mode	SA, WCDMA, C2K, WIMAX OFDMA, TD-SCDMA, 1xEVDO, DTMB, DVB-T/H
Notes	Bandwidth sub op code, 1 is for BTS, 2 for MS. Default is BTS. You must be in the Spectrum Analysis mode, W-CDMA mode, cdma2000 mode, TD-SCDMA mode, DTMB mode, DVB-T/H mode, 1xEVDO mode or WIMAX OFDMA mode to use this command. Use :INSTRument:SElect to set the mode.
Preset	SA: 100 kHz WCDMA: 75 kHz C2K: 24 kHz WIMAX OFDMA: 30 kHz TD-SCDMA: 300 kHz 1xEVDO: 300.0kHz DTMB: 39kHz DVB-T/H: 39kHz ON
State Saved	Saved in instrument state.
Min	1 Hz
Max	50 MHz
Instrument S/W Revision	Prior to A.02.00

VBW/RBW

Sets the Video BW/Resolution BW Ratio to calculate the Channel Resolution BW and Channel Video BW. The VBW/RBW Ratio can be set manually or put in to auto mode.

Remote Command	[:SENSE] :SEMAsk :BANDwidth [1] 2 :VIDEo :RATio <real> [:SENSE] :SEMAsk :BANDwidth [1] 2 :VIDEo :RATio [:SENSE] :SEMAsk :BANDwidth [1] 2 :VIDEo :RATio :AUTO OFF ON 1 0 [:SENSE] :SEMAsk :BANDwidth [1] 2 :VIDEo :RATio :AUTO?
Example	SEM:BAND:VID:RAT 0.1 SEM:BAND:VID:RAT? SEM:BAND:VID:RAT:AUTO ON SEM:BAND:VID:RATIO:AUTO?
Dependencies/Couplings	When Res BW is set manually, Mode coupling is set to MANual When set to Auto, the VBW/RBW Ratio is automatically calculated.
Key Path	Meas Setup, Ref Chan

Mode	SA, WCDMA, C2K, WIMAX OFDMA, TD-SCDMA mode, 1xEVDO, DTMB, DVB-T/H
Notes	Bandwidth sub op code, 1 is for BTS, 2 for MS. Default is BTS. You must be in the Spectrum Analysis mode, W-CDMA mode, cdma2000 mode, TD-SCDMA mode, DTMB mode, DVB-T/H mode, 1xEVDO mode or WIMAX OFDMA mode to use this command. Use :INSTRument:SElect to set the mode.
Preset	SA, WCDMA, C2K: 1.0 WIMAX OFDMA: 0.3 TD-SCDMA: 10 1xEVDO: 10.0 DTMB: 10 DVB-T/H: 10 OFF
State Saved	Saved in instrument state.
Min	0.00001
Max	3000000
Instrument S/W Revision	Prior to A.02.00

Power Ref

Sets the power reference in the carrier that will be used to compute the relative values for the offsets.

Key Path	Meas Setup Ref Chan
Instrument S/W Revision	Prior to A.02.00

Total Pwr Ref

Sets the power in the carrier (ref channel) that will be used to compute the relative power values for the offsets. When the state is set to auto, this value is set to the measured carrier reference power. When set to manual, the result takes on the last measured value, or can be manually entered.

Remote Command	[:SENSE]:SEMAsk:CARRier[:POWER] <real> [:SENSE]:SEMAsk:CARRier[:POWER]? [:SENSE]:SEMAsk:CARRier:AUTO[:STATE] OFF ON 1 0 [:SENSE]:SEMAsk:CARRier:AUTO[:STATE]?
-----------------------	--

Spectrum Emission Mask Measurement Meas Setup

Example	SEM:CARR 100dBm SEM:CARR? SEM:CARR:AUTO OFF SEM:CARR:AUTO?
Dependencies/Couplings	This "Total Power Ref" parameter is coupled with the "Meas Type" parameter. The softkey would be active if the Meas Type is set to Total Power Ref. Otherwise, grayout.
Key Path	Meas Setup, Ref Chan, Power Ref
Mode	SA, WCDMA, C2K, WIMAX OFDMA, TD-SCDMA, 1xEVDO, DTMB, DVB-T/H
Notes	The min and max values given are for Meas Type = Total Pwr Ref. You must be in the Spectrum Analysis mode, W-CDMA mode, cdma2000 mode, TD-SCDMA mode, DTMB mode, DVB-T/H mode, 1xEVDO mode or WIMAX OFDMA mode to use this command. Use :INSTRUMENT:SELEct to set the mode. This BAF SCPI command is available in all the Meas Type case.
Preset	Measured carrier reference power
State Saved	Saved in instrument state.
Min	-200 dBm
Max	200 dBm
Instrument S/W Revision	Prior to A.02.00

PSD Ref

Sets the power spectral density in the carrier that is used to compute the relative power spectral density values for the offsets when Meas Type is set to PSD Ref. When the state is set to auto, this will be set to the measured carrier power spectral density.

Remote Command	[:SENSe] :SEMAsk :CARRier :CPSD <real> [:SENSe] :SEMAsk :CARRier :CPSD?
Example	SEM:CARR:CPSD -80 SEM:CARR:CPSD?
Dependencies/Couplings	See Couplings This "PSD Ref" parameter is coupled with the "Meas Type" parameter. The softkey will be active if the Meas Type is set to PSD Ref. Otherwise, grayout.
Key Path	Meas Setup, Ref Chan, Power Ref
Mode	SA, WCDMA, C2K , WIMAX OFDMA, TD-SCDMA, 1xEVDO, DTMB, DVB-T/H

Notes	<p>Although the default value is defined, the value is recalculated by the measurement result just after completing the measurement.</p> <p>Carrier sub op code. 1 for BTS, 2 for MS. Default is BTS.</p> <p>You must be in the Spectrum Analysis mode, W-CDMA mode, cdma2000 mode, TD-SCDMA mode, DTMB mode, DVB-T/H mode, 1xEVDO mode or WIMAX OFDMA mode to use this command. Use :INSTRUMENT:SElect to set the mode.</p>
Preset	Measured carrier PSD reference power
State Saved	Saved in instrument state.
Min	-200
Max	200
Instrument S/W Revision	Prior to A.02.00

Spectrum Peak Ref

Sets the spectrum peak power in the carrier that is used to compute the relative power spectral density values for the offsets when Meas Type is set to Spectrum Peak Ref. When the state is set to auto, this will be set to the measured carrier spectrum peak power. When set to manual, the result takes on the last measured value, or can be manually entered

Remote Command	<pre>[:SENSe] :SEMAsk :CARRier :PEAK [:POWer] <real> [:SENSe] :SEMAsk :CARRier :PEAK [:POWer] ?</pre>
Example	<pre>SEM:CARR:PEAK -80 SEM:CARR:PEAK:POWER?</pre>
Dependencies/Couplings	<p>See Couplings</p> <p>This "Spectrum Peak Ref" parameter is coupled with the "Meas Type" parameter. This softkey would be active if the "Meas Type" is set to "Spectrum Peak Ref". Otherwise, grayout.</p>
Key Path	Meas Setup, Ref Chan, Power Ref
Mode	SA, WCDMA, C2K , WIMAX OFDMA, TD-SCDMA, 1xEVDO, DTMB, DVB-T/H
Notes	<p>Although the default value is defined, the value is recalculated by the measurement result just after completing the measurement.</p> <p>Carrier sub op code. 1 for BTS, 2 for MS. Default is BTS.</p> <p>You must be in the Spectrum Analysis mode, W-CDMA mode, cdma2000 mode, TD-SCDMA mode, DTMB mode, DVB-T/H mode, 1xEVDO mode or WIMAX OFDMA mode to use this command. Use :INSTRUMENT:SElect to set the mode.</p>
Preset	Measured carrier Spectrum Peak reference power
State Saved	Saved in instrument state.

Spectrum Emission Mask Measurement Meas Setup

Min	-200
Max	200
Instrument S/W Revision	Prior to A.02.00

Offsets/Limits

Accesses a menu that enables you to set up the measurement parameters for the offset pairs. For example, you can assign the start and stop frequencies, select the resolution bandwidth, and set the sweep time.

Key Path	Meas Setup
Instrument S/W Revision	Prior to A.02.00

Offset

Selects the offset pairs (upper and lower) that affect the menu keys, and displays the memory selection menu from A to F. The memory selection menu allows you to store up to 5 sets of parameter values for the offset pairs, such as Start Freq, Stop Freq, Sweep Time, Res BW, Meas BW, Abs Start, and Abs Stop. Press Offset until the letter of the desired offset (A, B, C, D, E, or F) is underlined. Only one selection at a time is shown on this menu key label.

Key Path	Meas Setup, Offsets/Limits
Mode	SA, WCDMA, C2K, WIMAX OFDMA, TD-SCDMA, 1xEVDO, DTMB, DVB-T/H
Preset	A
Range	A B C D E F
Instrument S/W Revision	Prior to A.02.00

Start Freq

Specifies the start frequency for the currently selected offset and enables you to toggle this function On or Off for each offset.

Remote Command	<pre>[:SENSe]:SEMask:OFFSet[1] 2:LIST:FREQuency:START <freq>,<freq>,<freq>,<freq>,<freq>,<freq> [:SENSe]:SEMask:OFFSet[1] 2:LIST:FREQuency:START? [:SENSe]:SEMask:OFFSet[1] 2:LIST:STATE ON OFF 1 0,ON OFF 1 0,ON OFF 1 0,ON OFF 1 0,ON OFF 1 0,ON OFF 1 0, ON OFF 1 0 [:SENSe]:SEMask:OFFSet[1] 2:LIST:STATE?</pre>
-----------------------	--

Example	<pre>SEM:OFFS2:LIST:FREQ:STAR 100 kHz SEM:OFFS2:LIST:FREQ:STAR? SEM:OFFS:LIST:STAT ON SEM:OFFS:LIST:STAT?</pre>
Dependencies/Couplings	<p>Coupled to Stop Freq. Start cannot go above the stop freq less 100Hz. Similarly Stop freq cannot go below Start Freq plus 100Hz.</p> <p>If the current mode is DVB-T/H, this value will be modified automatically according to the limit type and the output power of the transmitter which is less or more than 25W.</p>
Key Path	Meas Setup, Offset/Limits
Mode	SA, WCDMA, C2K, WIMAX OFDMA, TD-SCDMA, 1xEVDO, DTMB, DVB-T/H
Notes	<p>Comma separated list of 6 values. OFFSet1 is for BTS, 2 for MS. Default is BTS.</p> <p>You must be in the Spectrum Analysis mode, W-CDMA mode, cdma2000 mode, TD-SCDMA mode, DTMB mode, DVB-T/H mode, 1xEVDO mode or WIMAX OFDMA mode to use this command. Use :INSTRument:SElect to set the mode.</p>

Spectrum Emission Mask Measurement Meas Setup

Preset	<p>SA: 2.515 MHz, 2.715 MHz, 3.515 MHz, 4.00 MHz, 8.00 MHz, 12.50 MHz</p> <p>WCDMA: 2.515 MHz, 2.715 MHz, 3.515 MHz, 4.000 MHz, 8.000 MHz, 12.50 MHz 2.515MHz, 4.000 MHz, 7.500 MHz, 8.500 MHz, 12.5 MHz, 15 MHz</p> <p>C2K: 765.0 kHz, 795.0 kHz, 1.995 MHz, 3.2531 MHz, 7.500 MHz, 7.5 MHz 900.0 kHz, 1.995 MHz, 2.2531 MHz, 8.500 MHz, 12.50 MHz, 12.5 MHz</p> <p>WIMAX OFDMA: 4.75MHz,5.45MHz,9.75MHz,14.75MHz,19.75MHz,24.75MHz 4.75MHz,5.45MHz,9.75MHz,14.75MHz,19.75MHz,24.75MHz</p> <p>TD-SCDMA: 815kHz,1015kHz,1815kHz,2.3MHz, ,2.3MHz,,2.3MHz 815kHz,1815kHz,2.9MHz, 2.9MHz,2.9MHz,2.9MHz</p> <p>1xEVDO: 765.0kHz, 795.0kHz, 1.995MHz, 3.253125MHz, 7.5MHz, 7.5MHz 900.0kHz, 1.995MHz, 1.995MHz, 1.995MHz, 1.995MHz, 1.995MHz, 1.995MHz</p> <p>DTMB: 3.8MHz, 4.2MHz, 6MHz, 12MHz, 12MHz, 12MHz</p> <p>DVB-T/H: 3.81MHz, 4.2MHz, 6MHz, 12MHz, 12MHz, 12MHz</p> <p>SA: ON, ON, ON, ON, ON, OFF</p> <p>WCDMA: ON, ON, ON, ON, ON, OFF ON, ON, ON, ON, OFF, OFF</p> <p>C2K: ON, ON, ON, OFF, OFF, OFF ON, ON, OFF, OFF, OFF, OFF</p> <p>WIMAX OFDMA: ON, ON, ON, OFF, OFF, OFF ON, ON, ON, OFF, OFF, OFF</p> <p>TD-SCDMA: ON, ON, ON, ON, OFF, OFF ON, ON, ON, OFF, OFF, OFF</p> <p>1xEVDO: ON, ON, ON, OFF, OFF, OFF ON, ON, OFF, OFF, OFF, OFF</p> <p>DTMB: ON, ON, ON, OFF, OFF, OFF</p> <p>DVB-T/H: ON, ON, ON, OFF, OFF, OFF</p>
State Saved	Saved in instrument state.
Min	0 Hz
Max	Stop Freq minus (-) 100 Hz (for that offset)
Instrument S/W Revision	Prior to A.02.00

Stop Freq

Specifies the stop frequency for the currently selected offset.

Remote Command

```
[ :SENSe ] : SEMask : OFFSet [ 1 ] | 2 : LIST : FREQuency : STOP
<freq> , <freq> , <freq> , <freq> , <freq> , <freq>

[ :SENSe ] : SEMask : OFFSet [ 1 ] | 2 : LIST : FREQuency : STOP?
```

Example	SEM:OFFS:LIST:FREQ:STOP 100 kHz SEM:OFFS:LIST:FREQ:STOP?
Dependencies/Couplings	Coupled to Start Freq. Start cannot go above the stop freq less 100Hz. Similarly Stop freq cannot go below Start Freq plus 100Hz. If the current mode is DVB-T/H, this value will be modified automatically according to the limit type and the output power of the transmitter which is less or more than 25W.
Key Path	Meas Setup, Offset/Limits
Mode	SA, WCDMA, C2K, WIMAX OFDMA, TD-SCDMA, 1xEVDO, DTMB, DVB-T/H
Notes	Comma separated list of 6 values. OFFSet1 is for BTS, 2 for MS. Default is BTS. You must be in the Spectrum Analysis mode, W-CDMA mode, cdma2000 mode, TD-SCDMA mode, DTMB mode, DVB-T/H mode, 1xEVDO mode or WIMAX OFDMA mode to use this command. Use :INSTrument:SElect to set the mode.
Preset	SA: 2.715 MHz, 3.515 MHz, 4.00 MHz, 8.00 MHz, 12.50 MHz, 15.0 MHz WCDMA:2.715 MHz, 3.515 MHz, 4.000 MHz, 8.000 MHz, 12.50 MHz, 15.0 MHz 3.485 MHz, 7.500 MHz, 8.500 MHz, 12.00 MHz, 15.00 MHz, 18.0 MHz C2K: 795.0 kHz, 1.995 MHz, 4.015 MHz, 4.0031 MHz, 12.50 MHz, 12.5 MHz 1.995 MHz, 4.015 MHz, 4.0031 MHz, 12.00 MHz, 15.00 MHz, 15.0 MHz WIMAX OFDMA: 5.45MHz,9.75MHz,14.75MHz,19.75MHz,24.75MHz,29.75MHz 5.45MHz,9.75MHz,14.75MHz,19.75MHz,24.75MHz,29.75MHz TD-SCDMA: 1015kHz,1815kHz,2.3MHz,4MHz, 4MHz,4MHz 1785kHz,2385kHz,3.5MHz, 3.5MHz ,3.5MHz ,3.5MHz 1xEVDO: 795.0kHz, 1.995MHz, 4.015MHz, 4.003125MHz, 12.5MHz, 12.5MHz 1.995MHz, 4.015MHz, 4.015MHz, 4.015MHz, 4.015MHz, 4.015MHz DTMB: 4.2MHz, 6MHz, 12MHz, 12MHz, 12MHz, 12MHz DVB-T/H: 4.2MHz, 6MHz, 12MHz, 12MHz, 12MHz, 12MHz
State Saved	Saved in instrument state.
Min	Start Freq plus (+) 100 Hz (for that offset)
Max	500 MHz
Instrument S/W Revision	Prior to A.02.00

Spectrum Emission Mask Measurement Meas Setup

Sweep Time

Specifies the sweep time for the currently selected offset and enables you to toggle this function On or Off for each offset.

Remote Command	<pre>[:SENSE]:SEMask:OFFSet[1] 2:LIST:SWEep:TIME <time>,<time>,<time>,<time>,<time>,<time> [:SENSE]:SEMask:OFFSet[1] 2:LIST:SWEep:TIME? [:SENSE]:SEMask:OFFSet[1] 2:LIST:SWEep:TIME:AUTO ON OFF 1 0,ON OFF 1 0,ON OFF 1 0,ON OFF 1 0,ON OFF 1 0, ON OFF 1 0 [:SENSE]:SEMask:OFFSet[1] 2:LIST:SWEep:TIME:AUTO?</pre>
Example	<pre>SEM:OFFS2:LIST:SWE:TIME 1.0 ms, 3.4 ms, 2.08 ms, 1.0 ms, 1.0 ms, 1.0 ms SEM:OFFS2:LIST:SWE:TIME? SEM:OFFS2:LIST:SWE:TIME:AUTO ON, ON, ON, ON, OFF, OFF SEM:OFFS2:LIST:SWE:TIME:AUTO?</pre>
Dependencies/Couplings	<p>When the sweep time is set manually, Mode coupling is set to MANual</p> <p>If the current mode is DVB-T/H, this value will be modified automatically according to the output power of the transmitter which is less or more than 25W.</p>
Key Path	Meas Setup, Offset/Limits
Mode	SA, WCDMA, C2K, WIMAX OFDMA, TD-SCDMA, 1xEVDO, DTMB, DVB-T/H
Notes	<p>Comma separated list of 6 values. OFFSet1 is for BTS, 2 for MS. Default is BTS.</p> <p>You must be in the Spectrum Analysis mode, W-CDMA mode, cdma2000 mode, TD-SCDMA mode, DTMB mode, DVB-T/H mode, 1xEVDO mode or WIMAX OFDMA mode to use this command. Use :INSTRument:SElect to set the mode.</p>
Preset	<p>Automatically calculated</p> <p>ON,ON,ON,ON,ON,ON</p>
State Saved	Saved in instrument state.
Min	1 ms
Max	10 s
Instrument S/W Revision	Prior to A.02.00

Offset Side

Specifies which offset side to measure.

You can turn off (not use) specific offsets with [:SENSE]:SEMask:OFFSet[n]:LIST:STATe.

BOTH - both of the negative (lower) and positive (upper) sidebands

NEGative - negative (lower) sideband only

POSitive - positive (upper) sideband only

Remote Command	<pre>[:SENSE] :SEMask:OFFSet[1] 2 :LIST:SIDE BOTH NEGative POSitive,BOTH NEGative POSitive,BOTH NEGa tive POSitive,BOTH NEGative POSitive,BOTH NEGative POSi tive,BOTH NEGative POSitive [:SENSE] :SEMask:OFFSet[1] 2 :LIST:SIDE?</pre>
Example	<pre>SEM:OFFS:LIST:SIDE BOTH SEM:OFFS:LIST:SIDE?</pre>
Key Path	Meas Setup, Offset/Limits
Mode	SA, WCDMA, C2K, WIMAX OFDMA, TD-SCDMA, 1xEVDO, DTMB, DVB-T/H
Notes	<p>OFFSet1 is for BTS, 2 for MS. Default is BTS.</p> <p>You must be in the Spectrum Analysis mode, W-CDMA mode, cdma2000 mode, TD-SCDMA mode, DTMB mode, DVB-T/H mode, 1xEVDO mode or WIMAX OFDMA mode to use this command. Use :INSTrument:SElect to set the mode.</p>
Preset	BOTH, BOTH, BOTH, BOTH, BOTH, BOTH BOTH, BOTH, BOTH, BOTH, BOTH, BOTH
State Saved	Saved in instrument state.
Range	Neg Both Pos
Instrument S/W Revision	Prior to A.02.00

Res BW

Specifies which Resolution BW filter to use when measuring the currently selected offset.

Offset Res BW Mode allows the instrument to determine the optimum Resolution BW filter to use when measuring the currently selected offset.. When changing the Meas BW parameter, if the Res BW needs to be changed to adhere to the rule

$$(N \times \text{Res BW}) \leq (\text{Stop freq of the offset} - \text{Start freq of the offset}),$$

Spectrum Emission Mask Measurement Meas Setup

where N is the multiplier, this setting will automatically be changed to manual.

Remote Command	<pre>[:SENSe]:SEMask:OFFSet[1] 2:LIST:BANDwidth[:RESolution] <bandwidth>,<bandwidth>,<bandwidth>,<bandwidth>,<bandwidth>,<bandwidth> [:SENSe]:SEMask:OFFSet[1] 2:LIST:BANDwidth[:RESolution] ? [:SENSe]:SEMask:OFFSet[1] 2:LIST:BANDwidth[:RESolution] :AUTO OFF ON 1 0,OFF ON 1 0,OFF ON 1 0,OFF ON 1 0,OFF ON 1 0, OFF ON 1 0 [:SENSe]:SEMask:OFFSet[1] 2:LIST:BANDwidth[:RESolution] :AUTO?</pre>
Example	<pre>SEM:OFFS2:LIST:BAND 30.0 kHz, 30.0 kHz, 30.0 kHz, 1.00 MHz,1.00 MHz, 1.00 MHz SEM:OFFS2:LIST:BAND? SEM:OFFS:LIST:BAND:AUTO 1,1,1,1,1,1 SEM:OFFS:LIST:BAND:AUTO?</pre>
Dependencies/Couplings	<p>Coupled to Start and Stop offset and Meas BW multiplier. This parameter must adhere to the rule $(N \times \text{Res BW}) \leq (\text{Stop freq of the offset} - \text{Start freq of the offset})$, where N is the multiplier. If the multiplier is changed, the Res BW will be changed to ensure this. When set manually, Res BW Coupling is set to manual.</p>
Key Path	Meas Setup, Offset/Limits
Mode	SA, WCDMA, C2K, WIMAX OFDMA, TD-SCDMA, 1xEVDO modeDTMB, DVB-T/H
Notes	<p>Comma separated list of 6 values. Sub op code OFFSet1 is for BTS, 2 for MS. Default is BTS.</p> <p>You must be in the Spectrum Analysis mode, W-CDMA mode, cdma2000 mode, TD-SCDMA mode, DTMB mode, DVB-T/H mode, 1xEVDO mode or WIMAX OFDMA mode to use this command. Use :INSTrument:SELEct to set the mode.</p>

Preset	<p>SA: 30.0 kHz, 30.0 kHz, 30.0 kHz, 1.00 MHz, 1.00 MHz, 1.00 MHz</p> <p>WCDMA: 30.00 kHz, 30.00 kHz, 30.00 kHz, 100.00 kHz, 1.000 MHz, 1.00 MHz 30.00 kHz, 1.000 MHz, 1.000 MHz, 1.000 MHz, 1.000 MHz, 1.00 MHz</p> <p>C2K: 3.00 kHz, 30.00 kHz, 30.00 kHz, 6.2 kHz, 1.000 MHz, 1.00 MHz 30.00 kHz, 30.00 kHz, 6.2 kHz, 1.000 MHz, 1.000 MHz, 1.00 MHz</p> <p>WIMAX OFDMA: 100 KHz, 100 KHz, 100 KHz, 100 KHz, 100 KHz, 100 KHz 100 KHz, 100 KHz, 100 KHz, 100 KHz, 100 KHz, 100 KHz</p> <p>TD-SCDMA: 30 kHz, 30 kHz, 30 kHz, 50 kHz, 1 MHz, 1 MHz 30 kHz, 30 kHz, 50 kHz, 1 MHz, 1 MHz, 1 MHz</p> <p>1xEVDO: 30.00 kHz, 30.00 kHz, 30.00 kHz, 6.2 kHz, 1.000 MHz, 1.000 MHz 30.00 kHz, 30.00 kHz, 30.00 kHz, 30.00 kHz, 30.00 MHz, 30.00 MHz</p> <p>DTMB: 3.9kHz, 3.9kHz, 3.9kHz, 3.9kHz, 3.9kHz, 3.9kHz</p> <p>DVB-T/H: 3.9kHz, 3.9kHz, 3.9kHz, 3.9kHz, 3.9kHz, 3.9kHz</p> <p>OFF, OFF, OFF, OFF, OFF, OFF OFF, OFF, OFF, OFF, OFF, OFF</p>
State Saved	Saved in instrument state.
Min	1 Hz
Max	8 MHz
Instrument S/W Revision	Prior to A.02.00

Meas BW

Allows you to specify a multiplier of Res BW for the measurement integration bandwidth.

Meas BW is multiplier integer number. It shows a ratio between Integration BW and Resolution BW of the measurement result.

$$\text{Integ BW} = \text{Meas BW} * \text{Resolution BW}$$

Integration BW is desired resolution bandwidth and Resolution BW is actual bandwidth for sweep. Measurement sweeps with Resolution BW and Meas BW compensates sweep resolution bandwidth to Integration BW.

If you set this parameter greater than 1, you can set Resolution BW narrower to avoid carrier power leakage effect to the offset power integration.

Remote Command	<pre>[:SENSE] :SEMask :OFFSet [1] 2 :LIST :BANDwidth :IMULti <integer> , <integer> , <integer> , <integer> , <integer> , <inte ger></pre> <pre>[:SENSE] :SEMask :OFFSet [1] 2 :LIST :BANDwidth :IMULti?</pre>
Example	<pre>SEM:OFFS2:LIST:BAND:IMUL 1,1,1,1,1,1</pre> <pre>SEM:OFFS2:LIST:BAND:IMUL?</pre>
Dependencies/Couplings	This parameter must adhere to the rule (N x Res BW) <= (Stop freq of the offset - Start freq of the offset), where N is the multiplier. If the Res Bw is changed, the multiplier will be changed to ensure this.

Spectrum Emission Mask Measurement Meas Setup

Key Path	Meas Setup, Offset/Limits
Mode	SA, WCDMA, C2K, WIMAX OFDMA, TD-SCDMA, 1xEVDO, DTMB, DVB-T/H
Notes	Comma separated list of 6 values. OFFSet1 is for BTS, 2 for MS. Default is BTS. You must be in the Spectrum Analysis mode, W-CDMA mode, cdma2000 mode, TD-SCDMA mode, DTMB mode, DVB-T/H mode, 1xEVDO mode or WIMAX OFDMA mode to use this command. Use :INSTrument:SELEct to set the mode.
Preset	SA: 1, 1, 1, 1, 1, 1 WCDMA: 1, 1, 1, 10, 1, 1 1, 1, 1, 1, 1, 1 C2K: 10, 1, 1, 1, 1, 1 1, 1, 1, 1, 1, 1 WIMAX OFDMA: 1, 1, 1, 1, 1, 1 1, 1, 1, 1, 1, 1 TD-SCDMA:1, 1, 1, 20, 1, 1 1, 1, 20, 1, 1, 1 1xEVDO: 1, 1, 1, 1, 1 1, 1, 1, 1, 1, 1 DTMB: 1, 1, 1, 1, 1, 1 DVB-T/H: 1, 1, 1, 1, 1, 1
State Saved	Saved in instrument state.
Min	1
Max	1000
Instrument S/W Revision	Prior to A.02.00

Video BW

Changes the analyzer post-detection filter.

Remote Command	[:SENSE] :SEMAsk:OFFSet [1] 2 :LIST:BA NDwidth:VIDeo <freq> , <freq> , <freq> , <freq> , <freq> , <freq> [:SENSE] :SEMAsk:OFFSet [1] 2 :LIST:BA NDwidth:VIDeo? [:SENSE] :SEMAsk:OFFSet [1] 2 :LIST:BA NDwidth:VIDeo:AUTO OFF ON 0 1 , OFF ON 0 1 , OFF ON 0 1 , OFF ON 0 1 , OFF ON 0 1 , OFF ON 0 1 [:SENSE] :SEMAsk:OFFSet [1] 2 :LIST:BA NDwidth:VIDeo:AUTO?
Example	SEM:OFFS2:LIST:BA ND:VID 3.00 kHz, 3.00 kHz, 3.00 kHz, 100.0 kHz,100.0 kHz, 100.0 kHz SEM:OFFS2:LIST:BA ND:VID? SEM:OFFS2:LIST:BA ND:VID:AUTO ON, ON, ON, ON, ON, ON SEM:OFFS2:LIST:BA ND:VID:AUTO?
Key Path	Meas Setup, Offset/Limits

Mode	SA, WCDMA, C2K, WIMAXOFDMA, TD-SCDMA, 1xEVDO, DTMB, DVB-T/H
Notes	Comma separated list of 6 values. Sub op code OFFSet1is for BTS, 2 for MS. Default is BTS. You must be in the Spectrum Analysis mode, W-CDMA mode, cdma2000 mode, TD-SCDMA mode, DTMB mode, DVB-T/H mode, 1xEVDO mode or WIMAX OFDMA mode to use this command. Use :INSTrument:SElect to set the mode.
Preset	SA: 300 Hz, 300 Hz, 300 Hz, 10 kHz, 10 kHz, 10 kHz WCDMA: 300 Hz, 300 Hz, 300 Hz, 1 kHz, 10 kHz, 10 kHz 300 Hz, 10 kHz, 10 kHz, 10 kHz, 10 kHz, 10 kHz C2K: 30 Hz, 300 Hz, 300 Hz, 62 Hz, 10 kHz, 10 kHz 300 Hz, 300 Hz, 62 Hz, 10 kHz, 10 kHz, 10 kHz WIMAX OFDMA: 30 kHz, 30 kHz, 30 kHz, 30 kHz, 30 kHz, 30 kHz TD-SCDMA: 300 kHz, 300 kHz, 300 kHz, 500 kHz, 1 MHz, 1 MHz 300 kHz, 300 kHz, 500 kHz, 1 MHz, 1 MHz, 1 MHz 1xEVDO: 300kHz, 300kHz, 300kHz, 62.5kHz, 10MHz, 10MHz 300kHz, 300kHz, 300kHz, 300kHz, 300kHz DTMB: 39kHz, 39kHz, 39kHz, 39kHz, 39kHz, 39kHz DVB-T/H: 39kHz, 39kHz, 39kHz, 39kHz, 39kHz, 39kHz ON, ON, ON, ON, ON, ON ON, ON, ON, ON, ON, ON
State Saved	Saved in instrument state.
Min	1 Hz
Max	50 MHz
Instrument S/W Revision	Prior to A.02.00

VBW/RBW

Selects the ratio between the video and resolution bandwidths.

Remote Command	[:SENSE]:SEMask:OFFSet[1] 2:LIST:BANDwidth:VIDeo:RATio <real> , <real> , <real> , <real> , <real> , <real>
	[:SENSe]:SEMask:OFFSet[1] 2:LIST:BANDwidth:VIDeo:RATio?
	[:SENSE]:SEMask:OFFSet[1] 2:LIST:BANDwidth:VIDeo:RATio: AUTO OFF ON 0 1, OFF ON 0 1, OFF ON 0 1, OFF ON 0 1, OFF ON 0 1, OFF ON 0 1
	[:SENSe]:SEMask:OFFSet[1] 2:LIST:BANDwidth:VIDeo:RATio: AUTO?

Spectrum Emission Mask Measurement Meas Setup

Example	SEM:OFFS2:LIST:BAND:VID:RAT 0.1, 0.1, 0.1, 0.1, 0.1, 0.1 SEM:OFFS2:LIST:BAND:VID:RAT? SEM:OFFS2:LIST:BAND:VID:RAT:AUTO ON, ON, ON, ON, ON, ON SEM:OFFS2:LIST:BAND:VID:RAT:AUTO?
Key Path	Meas Setup, Offset/Limits
Mode	SA, WCDMA, C2K, WIMAX OFDMA, TD-SCDMA, 1xEVDO, DTMB, DVB-T/H
Notes	Comma separated list of 6 values. OFFSet1 is for BTS, 2 for MS. Default is BTS. You must be in the Spectrum Analysis mode, W-CDMA mode, cdma2000 mode, TD-SCDMA mode, DTMB mode, DVB-T/H mode, 1xEVDO mode or WIMAX OFDMA mode to use this command. Use :INSTrument:SElect to set the mode.
Preset	SA, WCDMA, C2K: 0.01, 0.01, 0.01, 0.01, 0.01, 0.01 0.01, 0.01, 0.01, 0.01, 0.01, 0.01 WIMAX OFDMA: 0.3, 0.3, 0.3, 0.3, 0.3, 0.3 TD-SCDMA: 10, 10, 10, 10, 1, 1 10, 10, 10, 1, 1, 1 1xEVDO: 10, 10, 10, 10, 10, 10 10, 10, 10, 10, 10, 10 DTMB: 10, 10, 10, 10, 10, 10 DVB-T/H: 10, 10, 10, 10, 10, 10 OFF, OFF, OFF, OFF, OFF, OFF OFF, OFF, OFF, OFF, OFF, OFF
State Saved	Saved in instrument state.
Min	0.00001
Max	3000000
Instrument S/W Revision	Prior to A.02.00

Limits

Accesses a menu that enables you to set the power limits for start and stop frequencies of the selected offsets.

Key Path	Meas Setup
Instrument S/W Revision	Prior to A.02.00

Abs Start Sets the absolute power level limit at the start frequency for the selected offset. The absolute power level limit ranges from –200 to +50 dBm.

The fail condition for each offset channel is set remotely by [:SENSe]:SEMAsk:OFFSet[n]:LIST:TEST.

You can turn off (not use) specific offset channels remotely with [:SENSe]:SEMAsk:OFFSet[n]:LIST:STATe.

The SCPI query returns the five (5) sets of real values currently set to the absolute power test limits.

Remote Command	<pre>[:SENSE] :SEMask :OFFSet [1] 2 :LIST :STARt :ABSolute <real> , <real> , <real> , <real> , <real> , <real> [:SENSE] :SEMask :OFFSet [1] 2 :LIST :STARt :ABSolute?</pre>
Example	<pre>SEM:OFFS2:LIST:STAR:ABS -12.50 dBm, -12.50 dBm, -24.50 dBm, -11.50 dBm, -11.50 dBm, -11.50 dBm SEM:OFFS2:LIST:STAR:ABS?</pre>
Dependencies/Couplings	<p>Coupled to Abs Stop if coupling set to “Couple”, that is, the Start value is equal to the Stop value.</p> <p>If the current mode is DVB-T/H, this value will be modified automatically according to the limit type and the output power of the transmitter which is less or more than 25W.</p>
Key Path	Meas Setup, Offset/Limits, Limits
Mode	SA, WCDMA, C2K, WIMAX OFDMA, TD-SCDMA, 1xEVDO, DTMB, DVB-T/H
Notes	<p>Comma separated list of 6 values. OFFSet1 is for BTS, 2 for MS. Default is BTS.</p> <p>You must be in the Spectrum Analysis mode, W-CDMA mode, cdma2000 mode, TD-SCDMA mode, DTMB mode, DVB-T/H mode, 1xEVDO mode or WIMAX OFDMA mode to use this command. Use :INSTrument:SElect to set the mode.</p>
Preset	<pre>SA, WIMAX OFDMA: -14.00 dBm , -14.00 dBm , -26.00 dBm , -13.00 dBm , -13.00 dBm, -13.00 dBm WCDMA: -12.50 dBm, -12.50 dBm, -24.50 dBm, -11.50 dBm, -11.50 dBm, -11.50 dBm -69.6 dBm, -54.3 dBm, -54.3 dBm, -54.3 dBm, -54.3 dBm, -54.3 dBm C2K: -27.00 dBm, -27.00 dBm, -27.00 dBm, -46.00 dBm, -13.00 dBm, -13.00 dBm -70.13 dBm, -70.13 dBm, -35.00 dBm, -13.00 dBm, -13.00 dBm, -13.00 dBm TD-SCDMA: -28 dBm, -28 dBm, -36 dBm, -21 dBm, -21 dBm, -21 dBm -71.3 dBm, -71.3 dBm, -56.07 dBm, -56.07 dBm, -56.07 dBm, -56.07 dBm 1xEVDO: -27.0dBm, -27.00 dBm, -27.00 dBm, -46.00 dBm, -13.00 dBm, -13.00 dBm -70.13 dBm, -70.13 dBm, -70.13 dBm, -70.13 dBm, -70.13 dBm, -70.13 dBm DTMB: -14.0dBm, -14.0dBm, -26.0dBm, -13.0dBm, -13.0dBm, -13.0dBm DVB-T/H: 11.2dBm, -29dBm, -41dBm, -66dBm, -82dBm, -82dBm</pre>
State Saved	Saved in instrument state.
Min	-200 dBm
Max	50 dBm

Spectrum Emission Mask Measurement Meas Setup

Instrument S/W Revision Prior to A.02.00

Abs Stop Sets the absolute power level limit at the stop frequency for the selected offset. The absolute power level limit ranges from –200 to +50 dBm. You can also toggle this function between couple and manual. If set to Couple, the **Abs Stop** power level limit is coupled to **Abs Start** to result in a flat limit line. If set to Man, Abs Start and Abs Stop take different values to result in a sloped limit line.

The SCPI query returns the five (5) sets of real values currently set to the offset stop absolute power limits.

Remote Command	<pre>[:SENSe]:SEMask:OFFSet[1] 2:LIST:STOP:ABSolute <real>, <real>, <real>, <real>, <real>, <real> [:SENSe]:SEMask:OFFSet[1] 2:LIST:STOP:ABSolute? [:SENSe]:SEMask:OFFSet[1] 2:LIST:STOP:ABSolute:COUPle ON OFF 1 0, ON OFF 1 0, ON OFF 1 0, ON OFF 1 0, ON OFF 1 0, ON OFF 1 0 [:SENSe]:SEMask:OFFSet[1] 2:LIST:STOP:ABSolute:COUPle?</pre>
Example	<pre>SEM:OFFS:LIST:STOP:ABS -12.50 dBm, -24.50 dBm, -24.50 dBm, -11.50 dBm, -11.50 dBm, -11.50 dBm SEM:OFFS1:LIST:STOP:ABS? SEM:OFFS:LIST:STOP:ABS:COUP ON, OFF, ON, ON, ON, ON SEM:OFFS:LIST:STOP:ABS:COUP?</pre>
Dependencies/Couplings	<p>Coupled to Abs Start if coupling set to “Couple”, that is, the Stop value is equal to the Start value.</p> <p>If the current mode is DVB-T/H, this value will be modified automatically according to the limit type and the output power of the transmitter which is less or more than 25W.</p>
Key Path	Meas Setup, Offset/Limits, Limits
Mode	SA, WCDMA, C2K, WIMAX OFDMA, TD-SCDMA, 1xEVDO, DTMB, DVB-T/H
Notes	<p>Comma separated list of 6 values. OFFSet1 is for BTS, 2 for MS. Default is BTS.</p> <p>You must be in the Spectrum Analysis mode, W-CDMA mode, cdma2000 mode, TD-SCDMA mode, DTMB mode, DVB-T/H mode, 1xEVDO mode or WIMAX OFDMA mode to use this command. Use :INSTrument:SElect to set the mode.</p>

Preset	<p>SA, WIMAX OFDMA: -14.00 dBm, -26.00 dBm, -26.00 dBm, -13.00 dBm, -13.00 dBm, -13.00 dBm</p> <p>WCDMA: -12.50 dBm, -24.50 dBm, -24.50 dBm, -11.50 dBm, -11.50 dBm, -11.50 dBm -69.6 dBm, -54.3 dBm, -54.3 dBm, -54.3 dBm, -54.3 dBm, -54.3 dBm</p> <p>C2K: -27.00 dBm, -27.00 dBm, -27.00 dBm, -46.00 dBm, -13.00 dBm, -13.00 dBm -70.13 dBm, -70.13 dBm, -35.00 dBm, -13.00 dBm, -13.00 dBm, -13.00 dBm</p> <p>TD-SCDMA: -28 dBm, -36 dBm, -36 dBm, -21 dBm, -21 dBm, -21 dBm -71.3 dBm, -71.3 dBm, -56.07 dBm, -56.07 dBm, -56.07 dBm, -56.07 dBm</p> <p>1xEVDO: -27dBm, -27.00 dBm, -27.00 dBm, -46.00 dBm, -13.00 dBm, -13.00 dBm -70.13 dBm, -70.13 dBm, -70.13 dBm, -70.13 dBm, -70.13 dBm, -70.13 dBm</p> <p>DTMB: -14.0dBm, -26.0dBm, -26.0dBm, -13.0dBm, -13.0dBm, -13.0dBm</p> <p>DVB-T/H: -29dBm, -41dBm, -66dBm, -82dBm, -82dBm, -82dBm</p> <p>SA,WIMAX OFDMA: ON, OFF, ON, ON, ON, ON</p> <p>WCDMA: ON, OFF, ON, ON, ON, ON ON, ON, ON, ON, ON, ON</p> <p>C2K: ON, ON, ON, ON, ON, OFF ON, ON, ON, ON, ON, OFF</p> <p>TD-SCDMA: ON, OFF, ON, ON, ON, ON ON, ON, ON, ON, ON, ON</p> <p>1xEVDO: ON, ON, ON, ON, ON, OFF ON, ON, ON, ON, ON, OFF</p> <p>DTMB: ON, OFF, ON, ON, ON, ON</p> <p>DVB-T/H: OFF, OFF, OFF, OFF, OFF, OFF</p>
State Saved	Saved in instrument state.
Min	-200 dBm
Max	50 dBm
Instrument S/W Revision	Prior to A.02.00

Rel Start Sets a relative power level limit at the start frequency for the selected offset. The relative power level limit ranges from -200 to +50 dBc.

The fail condition is set remotely by [:SENSE]:SEMAsk:OFFSet[n]:LIST:TEST for each offset channel test.

You can turn off (not use) specific offset channels remotely with [:SENSE]:SEMAsk:OFFSet[n]:LIST:STATE.

The SCPI query returns the five (5) sets of real values currently set to the relative power test limits.

Remote Command

```
[:SENSE]:SEMAsk:OFFSet[1]|2:LIST:START:RCARrier
<rel_ampl>, <rel_ampl>, <rel_ampl>, <rel_ampl>, <rel_ampl>,
<rel_ampl>

[:SENSE]:SEMAsk:OFFSet[1]|2:LIST:START:RCARrier?
```

Spectrum Emission Mask Measurement Meas Setup

Example	SEM:OFFS:LIST:STAR:RCAR -30.00 dB, -30.00 dB, -30.00 dB, -30.00 dB, -30.00 dB, -30.00 dB SEM:OFFS:LIST:STAR:RCAR?
Dependencies/Couplings	Coupled to Rel Stop is coupling set to “Couple”, that is, Start is made the same as Stop. If the current mode is DVB-T/H, this value will be modified automatically according to the limit type the output power of the transmitter which is less or more than 25W.
Key Path	Meas Setup, Offset/Limits, Limits
Mode	SA, WCDMA, C2K, WIMAX OFDMA, TD-SCDMA, 1xEVDO, DTMB, DVB-T/H
Notes	See the following table for the default values for each Radio Standard. Comma separated list of 6 values. OFFSet1 is for BTS, 2 for MS. Default is BTS. You must be in the Spectrum Analysis mode, W-CDMA mode, cdma2000 mode, TD-SCDMA mode, DTMB mode, DVB-T/H mode, 1xEVDO mode or WIMAX OFDMA mode to use this command. Use :INSTRument:SELEct to set the mode.
Preset	SA: -30.00 dB, -30.00 dB, -30.00 dB, -30.00 dB, -30.00 dB, -30.00 dB WCDMA: -30.00 dB, -30.00 dB, -30.00 dB, -30.00 dB, -30.00 dB, -30.00 dB -33.73 dB, -34.00 dB, -37.50 dB, -47.50 dB, -47.50 dB, -47.50 dB C2K: -45.00 dB, -45.00 dB, -55.00 dB, -55.00 dB, -55.00 dB, -55.00 dB -42.00 dB, -54.00 dB, -54.00 dB, -54.00 dB, -54.00 dB, -54.00 dB WIMAX OFDMA: 0 dB, -25 dB, -32 dB, -50 dB, -50 dB, -50 dB TD-SCDMA: -54.00 dB, -54.00 dB, -62.00 dB, -47.00 dB, -47.00 dB, -47.00 dB -35.00 dB, -49.00 dB, -49.00 dB, -49.00 dB, -49.00 dB, -49.00 dB 1xEVDO: -45dBc, -45.00 dB, -55.00 dB, -55.00 dB, -55.00 dB, -55.00 dB -42dBc, -54.00 dB, -54.00 dB, -54.00 dB, -54.00 dB, -54.00 dB DTMB: -32.8dB, -83dB, -95dB, -120dB, -120dB, -120dB DVB-T/H: -30dB, -30dB, -30dB, -30dB, -30dB, -30dB
State Saved	Saved in instrument state.
Min	-200 dB
Max	50 dB
Instrument S/W Revision	Prior to A.02.00

Rel Stop Sets a relative power level limit at the stop frequency for the selected offset. The relative power level limit ranges from -200 to +50 dBc.

The fail condition is set remotely by [:SENSE]:SEMAsk:OFFSet[n]:LIST:TEST for each offset channel.

You can turn off (not use) specific offset channels remotely with
[:SENSe]:SEMask:OFFSet[n]:LIST:STATe.

The SCPI query returns the five (5) sets of real values currently set to the offset stop relative power limits.

Remote Command	<pre>[:SENSe]:SEMask:OFFSet[1] 2:LIST:STOP:RCARrier <rel_ampl>,<rel_ampl>,<rel_ampl>,<rel_ampl>,<rel_ampl>, <rel_ampl> [:SENSe]:SEMask:OFFSet[1] 2:LIST:STOP:RCARrier? [:SENSe]:SEMask:OFFSet[1] 2:LIST:STOP:RCARrier:COUPle ON OFF 1 0,ON OFF 1 0,ON OFF 1 0,ON OFF 1 0,ON OFF 1 0, ON OFF 1 0 [:SENSe]:SEMask:OFFSet[1] 2:LIST:STOP:RCARrier:COUPle?</pre>
Example	<pre>SEM:OFFS:LIST:STOP:RCAR -30.00 dB, -30.00 dB, -30.00 dB, -30.00 dB, -30.00 dB, -30.00 dB SEM:OFFS:LIST:STOP:RCAR? SEM:OFFS:LIST:STOP:RCAR:COUP ON, ON, ON, ON, ON, ON SEM:OFFS:LIST:STOP:RCAR:COUP?</pre>
Dependencies/Couplings	<p>Coupled to Rel Start if coupling set to “Couple”, that is, Start is made the same as Stop.</p> <p>If the current mode is DVB-T/H, this value will be modified automatically according to the limit type and the output power of the transmitter which is less or more than 25W.</p>
Key Path	Meas Setup, Offset/Limits, Limits
Mode	SA, WCDMA, C2K, WIMAX OFDMA, TD-SCDMA, 1xEVDO, DTMB, DVB-T/H
Notes	<p>See the following table for the default values for each Radio Standard.</p> <p>Comma separated list of 6 values. OFFSet1 is for BTS, 2 for MS. Default is BTS.</p> <p>You must be in the Spectrum Analysis mode, W-CDMA mode, cdma2000 mode, TD-SCDMA mode, DTMB mode, DVB-T/H mode, 1xEVDO mode or WIMAX OFDMA mode to use this command. Use :INSTRument:SElect to set the mode.</p>

Spectrum Emission Mask Measurement Meas Setup

Preset	SA: -30.00 dB, -30.00 dB, -30.00 dB, -30.00 dB, -30.00 dB, -30.00 dB WCDMA: -30.00 dB, -30.00 dB, -30.00 dB, -30.00 dB, -30.00 dB, -30.00 dB -48.28 dB, -37.50 dB, -47.50 dB, -47.50 dB, -47.50 dB, -47.50 dB C2K: -45.00 dB, -45.00 dB, -55.00 dB, -55.00 dB, -55.00 dB, -55.00 dB -42.00 dB, -54.00 dB, -54.00 dB, -54.00 dB, -54.00 dB, -54.00 dB WIMAX OFDMA: -25 dB, -32 dB, -50 dB, -50 dB, -50 dB, -50 dB TD-SCDMA: -54.00 dB, -62.00 dB, -62.00 dB, -47.00 dB, -47.00 dB, -47.00 dB -49.00 dB, -64.00 dB, -49.00 dB, -49.00 dB, -49.00 dB, -49.00 dB 1xEVDO: -45dB, -45.00 dB, -55.00 dB, -55.00 dB, -55.00 dB, -55.00 dB -42dB, -54.00 dB, -54.00 dB, -54.00 dB, -54.00 dB, -54.00 dB DTMB: -83dB, -95dB, -120dB, -120dB, -120dB, -120dB DVB-T/H: -73dB, -85dB, -110dB, -126dB, -126dB, -126dB SA: ON, ON, ON, ON, ON, ON WCDMA: ON, ON, ON, ON, ON, ON OFF, OFF, OFF, ON, ON, ON C2K: ON, ON, ON, ON, ON, OFF ON, ON, ON, ON, ON, OFF WIMAX OFDMA: OFF, OFF, OFF, ON, ON, ON OFF, OFF, OFF, ON, ON, ON TD-SCDMA: ON, OFF, ON, ON, ON, ON OFF, OFF, ON, ON, ON, ON 1xEVDO: ON, ON, ON, ON, ON, OFF ON, ON, ON, ON, ON, OFF DTMB: OFF, OFF, OFF, OFF, OFF, OFF DVB-T/H: ON, ON, ON, ON, ON, ON
State Saved	Saved in instrument state.
Min	-200 dB
Max	50 dB
Instrument S/W Revision	Prior to A.02.00

Fail Mask Selects one of the logic keys for fail conditions between the measurement results and the test limits:

Absolute and **Relative** both check the results against the respective limit.

OR checks against both limits, failing if either of the limits is broken.

AND will only display a fail if both of the limits are broken.

The absolute or relative power limit value for each offset channel can be set remotely with [:SENSe]:SEMAsk:OFFSet[n]:LIST:ABSolute or [:SENSe]:SEMAsk:OFFSet[n]:LIST:RCARrier.

You can turn off (not use) specific offset channels remotely with

[[:SENSe]:SEMAsk:OFFSet[n]:LIST:STATe.

Remote Command	<pre>[:SENSe] :SEMAsk :OFFSet [1] 2 :LIST :TEST ABSolute AND OR RELative , ABSolute AND OR RELative , ABSolute AND OR RELative , ABSolute AND OR RELative , ABSolute AND OR RELative , ABSolute AND OR RELative [:SENSe] :SEMAsk :OFFSet [1] 2 :LIST :TEST?</pre>
Example	<pre>SEM:OFFS:LIST:TEST ABS, ABS, ABS, ABS, ABS, ABS SEM:OFFS:LIST:TEST?</pre>
Dependencies/Couplings	<p>None</p> <p>If the current mode is DVB-T/H, this value will be modified automatically according to the limit type and the output power of the transmitter which is less or more than 25W.</p>
Key Path	Meas Setup, Offset/Limits, Limits
Mode	SA, WCDMA, C2K, WIMAX OFDMA, TD-SCDMA, 1xEVDO, DTMB, DVB-T/H
Notes	<p>See the following table for the default values for each Radio Standard.</p> <p>Comma separated list of 6 values. OFFSet1 is for BTS, 2 for MS. Default is BTS.</p> <p>You must be in the Spectrum Analysis mode, W-CDMA mode, cdma2000 mode, TD-SCDMA mode, DTMB mode, DVB-T/H mode, 1xEVDO mode or WIMAX OFDMA mode to use this command. Use :INSTrument:SElect to set the mode.</p>
Preset	<pre>SA: ABS, ABS, ABS, ABS, ABS, ABS WCDMA: ABS, ABS, ABS, ABS, ABS, ABS AND, AND, AND, AND, AND, AND C2K: REL, REL, REL, ABS, REL, REL AND, AND, ABS, REL, REL, REL WIMAX OFDMA: REL, REL, REL, REL, REL, REL REL, REL, REL, REL, REL, REL TD-SCDMA: ABS, ABS, ABS, ABS, ABS, ABS AND, AND, AND, AND, AND, AND 1xEVDO: REL, REL, REL, ABS, REL, REL AND, AND, AND, OR, AND, AND DTMB: REL, REL, REL, REL, REL, REL DVB-T/H: ABS, ABS, ABS, ABS, ABS, ABS</pre>
State Saved	Saved in instrument state.
Range	Absolute Relative Abs AND Rel Abs OR Rel
Instrument S/W Revision	Prior to A.02.00

Method

Sets the measurement method

Integ BW-enables you to set the channel integration bandwidth.

RRC Weight-selects Root Raised Cosine (RRC) filtering of the carriers and all adjacent channels. The α value (rolloff) for the filter is set to the value of the Filter Alpha parameter.

Remote Command	[:SENSe] :SEMAsk:FILTer [:RRC] [:STATe] OFF ON 0 1 [:SENSe] :SEMAsk:FILTer [:RRC] [:STATe] ?
Example	SEM:FILT ON SEM:FILT?
Key Path	Meas Setup
Mode	SA, WCDMA, WIMAX OFDMA, TD-SCDMA, DTMB, DVB-T/H
Notes	For the CDMA2K and CDMA1xEVDO mode, this key is not available. 1 ON = RRC Weight, 0 OFF = IntegBW You must be in the Spectrum Analysis mode, W-CDMA mode or TD-SCDMA mode to use this command. Use :INSTRument:SElect to set the mode.
Preset	SA, WIMAX OFDMA, DVB-T/H: OFF WCDMA, TD-SCDMA, DTMB: ON
State Saved	Saved in instrument state.
Range	RRCWeight IntegBW
Instrument S/W Revision	Prior to A.02.00

Filter Alpha

Sets the alpha value for the RRC Filter.

Remote Command	[:SENSe] :SEMAsk:FILTer [:RRC] :ALPHa <real> [:SENSe] :SEMAsk:FILTer [:RRC] :ALPHa?
Example	SEM:FILT:ALPH 0.3 SEM:FILT:ALPH?
Key Path	Meas Setup
Mode	SA, WCDMA, WIMAX OFDMA, TD-SCDMA, DTMB, DVB-T/H
Notes	For the CDMA2K and CDMA1xEVDO mode, this key is not available. You must be in the Spectrum Analysis mode, DTMB mode, DVB-T/H mode, W-CDMA mode or TD-SCDMA mode to use this command. Use :INSTRument:SElect to set the mode.

Preset	0.22 DTMB: 0.05
State Saved	Saved in instrument state.
Min	0.01
Max	1.0
Instrument S/W Revision	Prior to A.02.00

Meas Preset

Restores all the measurement parameters to their default values.

Remote Command	:CONFigure:SEMask
Example	CONF:SEM
Dependencies/Couplings	Selecting Meas Preset will restore all measurement parameters to their default values.
Key Path	Meas Setup
Mode	SA, WCDMA, C2K, WIMAX OFDMA, TD-SCDMA, 1xEVDO, DTMB, DVB-T/H
Notes	You must be in the Spectrum Analysis mode, W-CDMA mode, cdma2000 mode, TD-SCDMA mode, DTMB mode, DVB-T/H mode, 1xEVDO mode or WIMAX OFDMA mode to use this command. Use :INSTrument:SElect to set the mode.
Instrument S/W Revision	Prior to A.02.00

Limits State

The key “Limits State” is only displayed in the TD-SCDMA mode. The mask lines could be drawn in two different ways, according to the 3GPP standard for the base station when the key’s value is “Std”; or by the user-defined specifications listed in the Offset/Limits menu.

Remote Command	[:SENSe]:SEMask:LIMits STD MAN [:SENSe]:SEMask:LIMits?
Example	SEM:LIM STD SEM:LIM?

Spectrum Emission Mask Measurement Meas Setup

Dependencies/Couplings	See Couplings When the value of the “Limits” key is Std, the parameters displayed on the Offset/Limits panel will be modified depending on the carrier power, which corresponds to the measurement standard of the base station. On top of that, all the keys except “Offset”, “Relative Atten”, “Offset Side” and “Limits” displayed on the “Offset/Limits” panel will be grayed out. Meanwhile all the keys displayed on the “Limits” panel will be grayed out as well. When the value of the “Limits” key is Man, all of the previous manual specifications will be restored, and the keys which previously grayed out will be enabled again.
Key Path	Meas Setup
Mode	TD-SCDMA
Notes	You must be in the TD-SCDMA mode to use this command. Use :INSTrument:SElect to set the mode.
Preset	MAN
State Saved	Saved in instrument state.
Range	STD MAN
Instrument S/W Revision	Prior to A.02.00

Limits Type (Only for DVB-T/H)

The key “Limits Type” is only displayed in the DVB-T/H mode. The mask lines could be drawn in three different ways, according to the non-critical case standard in ETSI 302–296 when the key’s value is “Non-Critical”; according to the critical case standard in ETSI 302–296 when the key’s value is “Critical”; or by the user-defined specifications listed in the Offset/Limits menu when the key’s value is “Manual”.

Remote Command	[:SENSE] :SEMAsk:LIMits:TYPE MANual NONCritical CRITICAL [:SENSE] :SEMAsk:LIMits:TYPE?
Example	SEM:LIM:TYPE NONC SEM:LIM:TYPE?

Dependencies/Couplings

1. When current radio bandwidth is 5MHz or 6MHz, this key only has one option: Manual. The “Non-Critical” and “Critical” keys will be grayed out. So the default value is Manual after measurement preset.
 2. When current radio bandwidth is 7MHz or 8MHz, this key has three options: Manual, Non-Critical and Critical. The default value is Non-Critical after measurement preset.
1. When the value of the “Limit Type” key is Non-Critical, the parameters displayed on the Offset/Limits panel will be modified automatically depending on the carrier power, according to the Non-critical case limits definition in ETSI 302–296, and the keys under the Offset/Limit except “Offset”, “Offset Side” and “Limits” will be grayed out. Meanwhile all the keys displayed on the “Limits” panel will be grayed out as well.
 2. When the value of the “Limit Type” key is Critical, the parameters displayed on the Offset/Limits panel will be modified automatically depending on the carrier power, according to the critical case limits definition in ETSI 302–296, and the keys under the Offset/Limit except “Offset”, “Offset Side” and “Limits” will be grayed out. Meanwhile all the keys displayed on the “Limits” panel will be grayed out as well.

When the value of the “Limit Type” key is Manual, all of the previous manual specifications will be restored, and the keys which previously grayed out will be enabled again.

Key Path

Meas Setup

Mode

DVB-T/H

Notes

You must be in the DVB-T/H mode to use this command. Use :INSTrument:SElect to set the mode.

Preset

NONCritical (if current radio bandwidth is 7MHz or 8MHz)
Manual (if current radio bandwidth is 5MHz or 6MHz)

State Saved

Saved in instrument state.

Range

Manual|Non-Critical|Critical

Instrument S/W Revision

A.02.00

Mode

See “[Mode](#)” on page 1145 in the section "Common Measurement Functions" for more information.

Mode Setup

See “[Mode Setup](#)” on page 1159 in the section "Common Measurement Functions" for more information.

Peak Search

There is no 'Peak Search' supported in Spectrum Emission Mask so this front-panel key will display a blank menu key when pressed.

Key Path	Front-panel key
Instrument S/W Revision	Prior to A.02.00

Recall

See [“Recall” on page 1179](#) in the section "Common Measurement Functions" for more information.

Restart

See “Restart” on page 1201 in the section "Common Measurement Functions" for more information.

Save

See “[Save](#)” on page 1203 in the section "Common Measurement Functions" for more information.

Single

See “[Single \(Single Measurement/Sweep\)](#)” on page 1229 in the section "Common Measurement Functions" for more information.

Source

See “[Source](#)” on page 1231 in the section "Common Measurement Functions" for more information.

Span X Scale

Span X Scale functionality is not supported in Spectrum Emission Mask, so this front panel key will display a blank key menu when pressed.

Key Path	Front-panel key
Instrument S/W Revision	Prior to A.02.00

Sweep/Control

Displays a menu that enables you to set up and control the sweep time, gate method, and source of the current measurement. See [“Sweep / Control” on page 1235](#) in the "Common Measurement Functions" section for more information.

Key Path	Front-panel key
Instrument S/W Revision	Prior to A.02.00

Pause

Pauses a measurement after the current data acquisition is complete. When Paused, the label on the key changes to Resume. Pressing the Resume key resumes the measurement at the point it was at when paused. See [“Pause/Resume” on page 1236](#) in “Common Measurement Functions” for more details.

Key Path	Sweep/Control
Instrument S/W Revision	Prior to A.02.00

Gate

Accesses a menu that enables you to control the gating function .See Measurement Functions for more details.

The Gate functionality is used to view signals best viewed by qualifying them with other events. See [“Gate ” on page 1236](#) in “common Measurement Functions” for more details.

Key Path	Sweep/Control
Instrument S/W Revision	Prior to A.02.00

Trace/Detector

Accesses a menu of functions that enable you to control trace and detector for the current measurement.

Key Path	Front-panel key
Instrument S/W Revision	Prior to A.02.00

Trace Type

Allows you to select the type of trace for the current measurement. The menu contains a 1-of-N selection of the trace type (Clear Write, Average, Max Hold, Min Hold).

Remote Command	:TRACe:SEMask:TYPE WRITe AVERAge MAXHold MINHold :TRACe:SEMask:TYPE?
Example	TRAC:SEM:TYPE MINH TRAC:SEM:TYPE?
Dependencies/Couplings	When Detector setting is “Auto” (:SENSe]:SEMask:DETEctor:AUTO?), Detector (:SENSe]:SEMask:DETEctor[:FUNCTioN]?) switches aligning with the switch of this parameter: “NORMal” with WRITe (Clear Write), “AVERAge” with AVERAge, “POSitive (peak)” with MAXHold, and “NEGative (peak)” with MINHold.
Key Path	Trace/Detector
Mode	SA, WCDMA, C2K, WIMAX OFDMA, TD-SCDMA, 1xEVDO, DTMB, DVB-T/H
Notes	WRITe = Clear Write AVERAge = Average MAXHold = Maximum Hold MINHold = Minimum Hold
Preset	AVERAge
State Saved	Saved in instrument state.
Range	WRITe AVERAge MAXHold MINHold
Instrument S/W Revision	Prior to A.02.00

Chan Detector

Accesses a menu of functions that enable you to control the detectors for reference channel. The following choices are available:

- Auto- the detector selected depends on marker functions, trace functions, average type, and the trace averaging function.

- Normal-the detector determines the peak of the CW-like signals, and it yields alternating maximums and minimums of noise-like signals. This is also referred to as Rosenfell detection.
- Average-the detector determines the average of the signal within the sweep points. The averaging method depends upon the Average Type selection (voltage, power or log scales).
- Peak-the detector determines the maximum of the signal within the sweep points.
- Sample-the detector indicates the instantaneous level of the signal at the center of the sweep points represented by each display point.
- Negative Peak-the detector determines the minimum of the signal within the sweep points.

Key Path	Trace/Detector
Instrument S/W Revision	Prior to A.02.00

Chan Detector Selection

Selects the detector mode for the reference channel.

Remote Command	[:SENSE] :SEMAsk:DETEctor:CARRier[:FUNction] AVERAge NEGAtive NORMAl POSitive SAMPle [:SENSE] :SEMAsk:DETEctor:CARRier[:FUNction]?
Example	SEM:DET:CARR NEG SEM:DET:CARR?
Dependencies/Couplings	See Couplings in the Trace Type section.
Key Path	Trace/Detector
Mode	SA, WCDMA, C2K, WIMAX OFDMA, TD-SCDMA, 1xEVDO, DTMB, DVB-T/H
Notes	When you manually select a detector (instead of selecting Auto), that detector is used regardless of other analyzer settings. Note: This detector setting affects the reference channel. There is not a per trace detector. You must be in the Spectrum Analysis mode, W-CDMA mode, cdma2000 mode, TD-SCDMA mode, DTMB mode, DVB-T/H mode, 1xEVDO mode or WIMAX OFDMA mode to use this command. Use :INSTrument:SElect to set the mode.
Preset	AVERAge
State Saved	Saved in instrument state.
Range	Normal Average Peak Sample Negative Peak
Instrument S/W Revision	Prior to A.02.00

Chan Detector Auto

Sets the detector to the default detection mode for the reference channel. This mode is dependent upon

Spectrum Emission Mask Measurement Trace/Detector

the current reference channel conditions.

Remote Command	<code>[:SENSE] :SEMAsk:DETEctor:CARRier:AUTO ON OFF 1 0</code> <code>[:SENSE] :SEMAsk:DETEctor:CARRier:AUTO?</code>
Example	<code>SEM:DET:CARR:AUTO OFF</code> <code>SEM:DET:CARR:AUTO?</code>
Key Path	Trace/Detector
Mode	SA, WCDMA, C2K, WIMAX OFDMA, TD-SCDMA, 1xEVDO, DTMB, DVB-T/H
Notes	See Couplings in the Trace Type section. You must be in the Spectrum Analysis mode, W-CDMA mode, cdma2000 mode, TD-SCDMA mode, DTMB mode, DVB-T/H mode, 1xEVDO mode or WIMAX OFDMA mode to use this command. Use INSTRument:SElect to set the mode.
Preset	ON
State Saved	Saved in instrument state.
Range	On Off
Instrument S/W Revision	Prior to A.02.00

Offset Detector

Accesses a menu of functions that enable you to control the detector for offsets. The following choices are available.

- Auto- the detector selected depends on marker functions, trace functions, average type, and the trace averaging function.
- Normal- the detector determines the peak of the CW-like signals, and it yields alternating maximums and minimums of noise-like signals. This is also referred to as Rosenfell detection.
- Average- the detector determines the average of the signal within the sweep points. The averaging method depends upon the Average Type selection (voltage, power or log scales).
- Peak- the detector determines the maximum of the signal within the sweep points.
- Sample- the detector indicates the instantaneous level of the signal at the center of the sweep points represented by each display point.
- Negative Peak- the detector determines the minimum of the signal within the sweep points.

Key Path	Trace/Detector
Instrument S/W Revision	Prior to A.02.00

Offset Detector Selection

Selects the detector mode for the offsets.

Remote Command	[:SENSE] :SEMAsk :DETector :OFFSet [:FUNction] AVERAge NEGAtive NORMAl POSitive SAMPlE [:SENSe] :SEMAsk :DETector :OFFSet [:FUNction] ?
Example	SEM:DET:OFFS AVER SEM:DET:OFFS?
Dependencies/Couplings	See Couplings in the Trace Type section.
Key Path	Trace/Detector
Mode	SA, WCDMA, C2K, WIMAX OFDMA, TD-SCDMA, 1xEVDO, DTMB, DVB-T/H
Notes	When you manually select a detector (instead of selecting Auto), that detector is used regardless of other analyzer settings. Note: This detector setting has effects all offsets. There is not a per trace detector. You must be in the Spectrum Analysis mode, W-CDMA mode, cdma2000 mode, TD-SCDMA mode, DTMB mode, DVB-T/H mode, 1xEVDO mode or WIMAX OFDMA mode to use this command. Use :INSTrument:SElect to set the mode.
Preset	SA, WCDMA, C2K, 1xEVDO, DTMB, DVB-T/H: POSitive WIMAX OFDMA, TD-SCDMA
State Saved	Saved in instrument state.
Range	Normal Average Peak Sample Negative Peak
Instrument S/W Revision	Prior to A.02.00

Offset Detector Auto

Sets the detector to the default detection mode for the offsets. This mode is dependent upon the current signal conditions of the offsets.

Remote Command	[:SENSE] :SEMAsk :DETector :OFFSet :AUTO ON OFF 1 0 [:SENSe] :SEMAsk :DETector :OFFSet :AUTO ?
Example	SEM:DET:OFFS:AUTO OFF SEM:DET:OFFS:AUTO?
Key Path	Trace/Detector
Mode	SA, WCDMA, C2K, WIMAX OFDMA, TD-SCDMA, 1xEVDO, DTMB, DVB-T/H

Spectrum Emission Mask Measurement Trace/Detector

Notes	See Couplings in the Trace Type section. You must be in the Spectrum Analysis mode, W-CDMA mode, cdma2000 mode, TD-SCDMA mode, DTMB mode, DVB-T/H mode, 1xEVDO mode or WIMAX OFDMA mode to use this command. Use :INSTrument:SElect to set the mode.
Preset	ON
State Saved	Saved in instrument state.
Range	On Off
Instrument S/W Revision	Prior to A.02.00

Trigger

Accesses a menu that enables you to select and control the trigger source for the current measurement.

See [“Trigger” on page 1253](#) in the "Common Measurement Functions" section for more information.

View/Display

Accesses a menu of functions that enable you to control the instrument display.

The following keys select how the results are displayed:

Abs Pwr Freq-displays the absolute power levels in dBm and the corresponding frequencies in the text window.

Rel Pwr Freq-displays the relative power levels in dBc and the corresponding frequencies in the text window.

Integrated Power-displays the absolute and relative power levels integrated throughout the bandwidths between the start and stop frequencies in the text window.

[“View Selection by name \(SCPI only\)” on page 568](#)

[“Views Selection by Number \(SCPI Only\)” on page 568](#)

View Selection by name (SCPI only)

Remote Command	:DISPlay:SEMask:VIEW[:SElect] APFReq RPFReq IPOWER :DISPlay:SEMask:VIEW[:SElect]?
Example	DISP:SEM:VIEW IPOW DISP:SEM:VIEW?
Dependencies/Couplings	In the SA mode, when "Radio Standard" is set to WLAN, IPOW is not available and the key is grayed out.
Key Path	View/Display
Mode	SA, WCDMA, C2K, WIMAX OFDMA, TD-SCDMA, 1xEVDO, DTMB, DVB-T/H
Notes	You must be in the Spectrum Analysis mode, W-CDMA mode, cdma2000 mode, TD-SCDMA mode, DTMB mode, DVB-T/H mode, 1xEVDO mode or WIMAX OFDMA mode to use this command. Use :INSTrument:SElect to set the mode.
Preset	SA, WCDMA, C2K, TD-SCDMA, 1xEVDO, DTMB, DVB-T/H: APFReq WIMAX OFDMA: RPFReq
State Saved	Saved in instrument state.
Range	Abs Pwr & Freq Rel Pwr & Freq Integrated Power
Instrument S/W Revision	Prior to A.02.00

Views Selection by Number (SCPI Only)

The following numerical selections select how the results are displayed:

1- displays the absolute power levels in dBm and the corresponding frequencies in the text window.

- 2- displays the relative power levels in dBc and the corresponding frequencies in the text window.
- 3- displays the absolute and relative power levels integrated throughout the bandwidths between the start and stop frequencies in the text window.

Remote Command	:DISPlay:SEMask:VIEW:NSElect <integer> :DISPlay:SEMask:VIEW:NSElect?
Example	DISP:SEM:VIEW:NSEL 2 DISP:SEM:VIEW:NSEL?
Mode	SA, WCDMA, C2K, WIMAX OFDMA, TD-SCDMA, 1xEVDO, DTMB, DVB-T/H
Notes	In the SA mode, when "Radio Standard" is set to WLAN, 3 is not available. You must be in the Spectrum Analysis mode, W-CDMA mode, cdma2000 mode, TD-SCDMA mode, DTMB mode, DVB-T/H mode, 1xEVDO mode or WIMAX OFDMA mode to use this command. Use :INSTrument:SElect to set the mode.
Preset	SA, WCDMA, C2K, TD-SCDMA, 1xEVDO, DTMB, DVB-T/H: 1 WIMAX OFDMA: 2
State Saved	Saved in instrument state.
Min	1
Max	3
Instrument S/W Revision	Prior to A.02.00
Key Path	Front-panel key
Instrument S/W Revision	Prior to A.02.00

Display

Accesses a menu of functions that enable you to set the display parameters.

See [“Display” on page 1307](#) in the "Common Measurement Functions" section for more information.

Key Path	View/Display
Instrument S/W Revision	Prior to A.02.00

Abs Pwr Freq

Abs Peak Pwr & Freq (Total Pwr Ref)

This view consists of the following two windows:

[“Trace Window” on page 571](#)

Spectrum Emission Mask Measurement
View/Display

“Results Window” on page 571

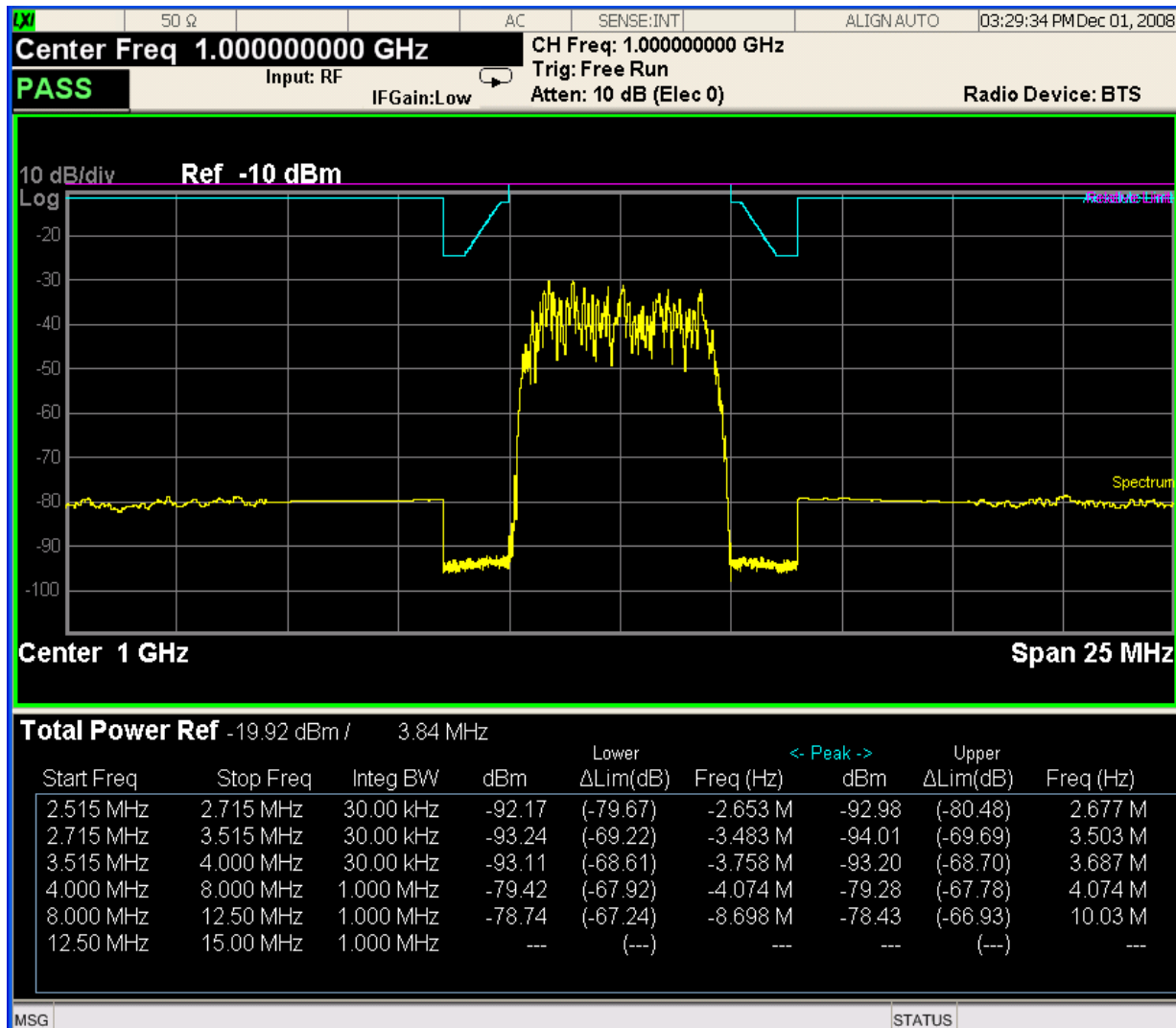

Trace Window

Corresponding Trace yellow - Combined trace from carrier and each offset

Results Window

Name	Corresponding Results
Total Pwr Ref	n=1 2nd element Absolute power at the reference area. Channel Integration Bandwidth
Start(Hz)	Start frequency for offset
Stop(Hz)	Stop frequency for offset
Meas BW(Hz)	Measurement bandwidth for offset
Lower Peak(dBm)	Absolute peak power on minimum margin point of the negative offset
Lower Lim(dB)	Minimum margin from limit line which is decided by Fail Mask setting on the negative offset
Lower Freq(Hz)	Frequency on minimum margin point of the negative offset
Upper Peak(dBm)	Absolute peak power on minimum margin point of the positive offset
Upper Lim(dB)	Minimum margin from limit line which is decided by Fail Mask setting on the positive offset
Upper Freq(Hz)	Frequency on minimum margin point of the positive offset

Abs Peak Pwr & Freq (PSD Ref)

This view consists of the following two windows:

[“Trace Window” on page 573](#)

[“Results Window” on page 573](#)

Spectrum Emission Mask Measurement
View/Display

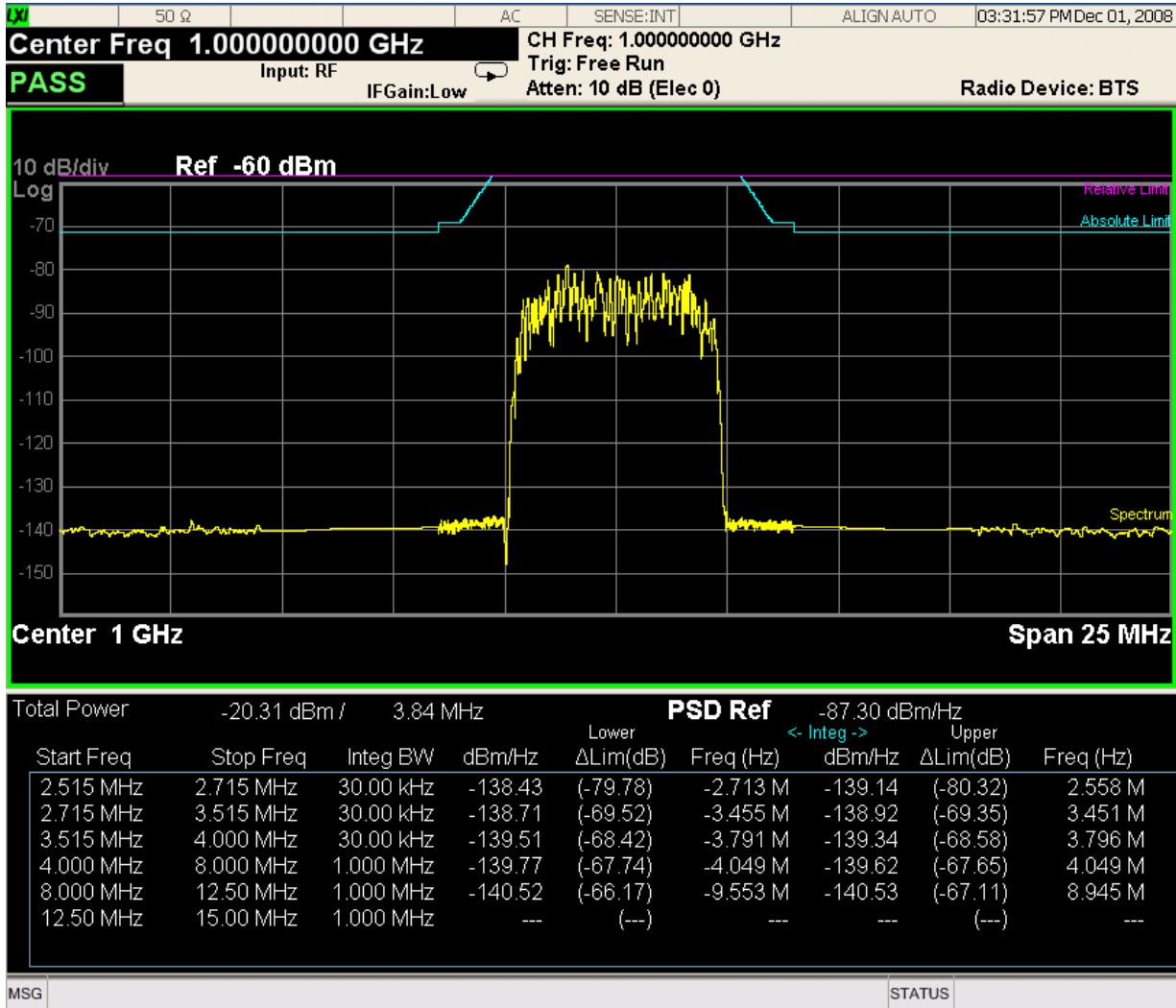

Trace Window

Corresponding Trace yellow - Combined trace from carrier and each offset

Results Window

Name	Corresponding Results
Total Pwr	n=1 2nd element Absolute power at the reference area. Channel Integration Bandwidth
PSD Ref	n=5 1st element Power spectral density reference at the reference area
Start(Hz)	Start frequency for offset
Stop(Hz)	Stop frequency for offset
Meas BW(Hz)	Measurement bandwidth for offset
Lower(dBm/Hz)	Absolute power spectrum density of the negative offset
Lower Lim(dB)	Minimum margin from limit line which is decided by Fail Mask setting on the negative offset
Lower Freq(Hz)	Frequency on minimum margin point of the negative offset
Upper(dBm/Hz)	Absolute power spectrum density of the positive offset
Upper Lim(dB)	Minimum margin from limit line which is decided by Fail Mask setting on the positive offset
Upper Freq(Hz)	Frequency on minimum margin point of the positive offset

Abs Peak Pwr & Freq (Spectrum Pk Ref)

This view consists of the following two windows:

“Trace Window” on page 573

“Results Window” on page 573

Spectrum Emission Mask Measurement
View/Display

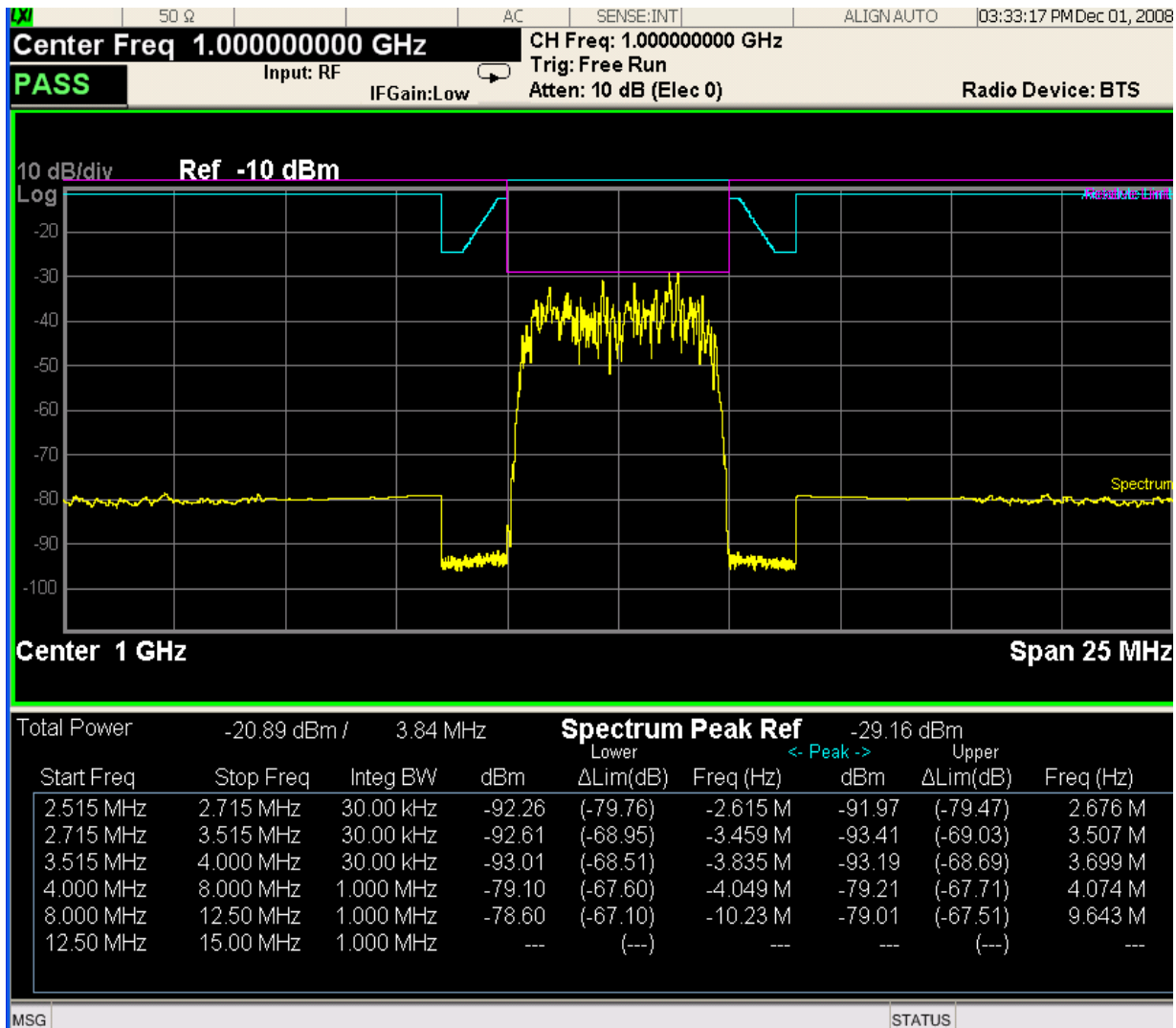

Trace Window

Corresponding Trace yellow - Combined trace from carrier and each offset

Results Window

Name	Corresponding Results
Total Pwr	Absolute power at the reference area. Channel Integration Bandwidth
Spectrum Peak Ref	n=5 1st element Spectrum peak power reference at the reference area
Start(Hz)	Start frequency for offset
Stop(Hz)	Stop frequency for offset
Meas BW(Hz)	Measurement bandwidth for offset
Lower(dBm)	Absolute peak power on minimum margin point of the negative offset
Lower Lim(dB)	Minimum margin from limit line which is decided by Fail Mask setting on the negative offset
Lower Freq(Hz)	Frequency on minimum margin point of the negative offset
Upper(dBm)	Absolute peak power on minimum margin point of the positive offset
Upper Lim(dB)	Minimum margin from limit line which is decided by Fail Mask setting on the positive offset
Upper Freq(Hz)	Frequency on minimum margin point of the positive offset
Key Path	View/Display
Instrument S/W Revision	Prior to A.02.00

Rel Pwr Freq

Rel Peak Pwr & Freq (Total Pwr Ref)

This view consists of the following two windows:

“Trace Window” on page 577

“Results Window” on page 577

Spectrum Emission Mask Measurement
View/Display

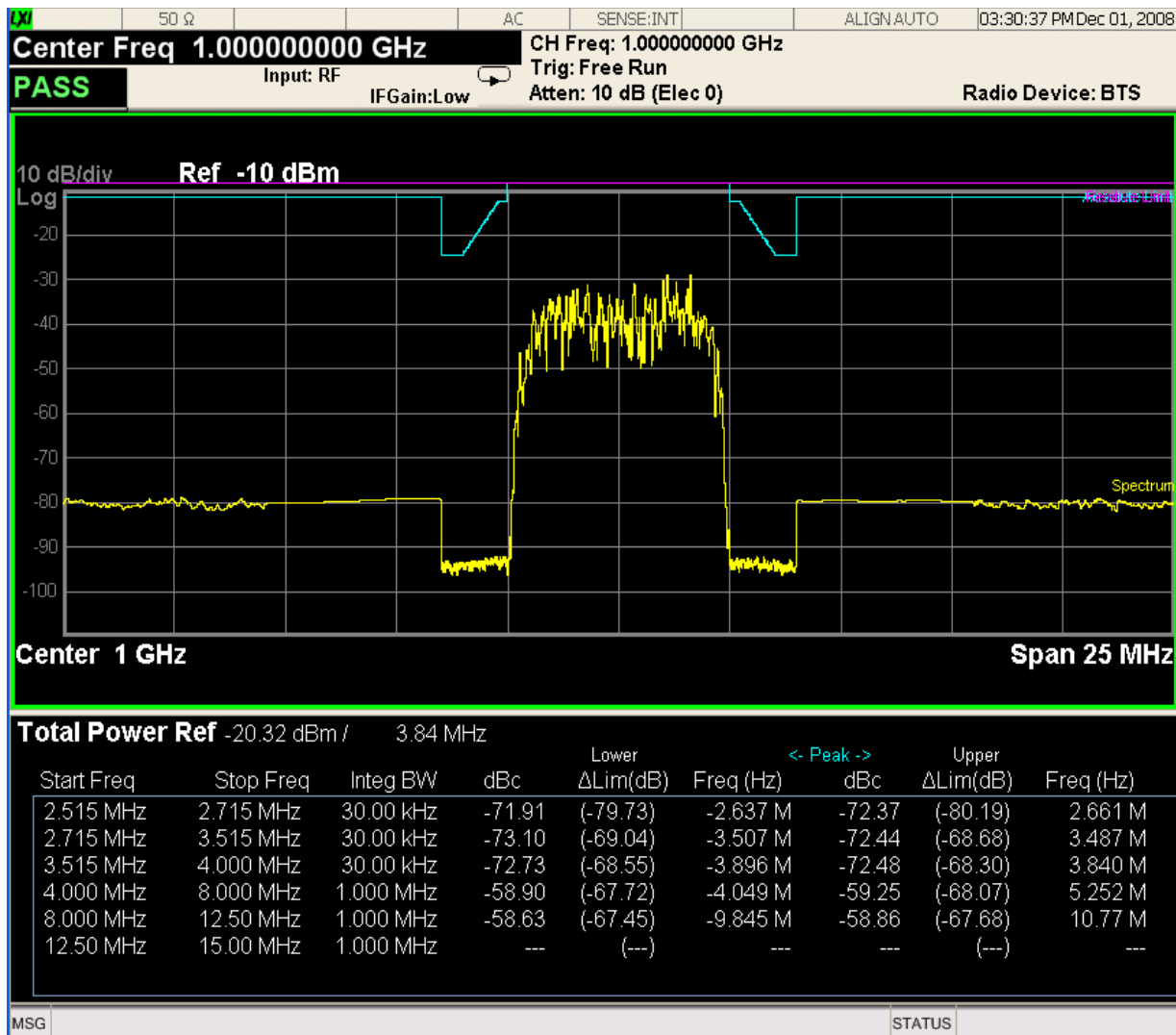

Trace Window

Corresponding Trace yellow - Combined trace from carrier and each offset

Results Window

Name	Corresponding Results
Total Pwr Ref	n=1 2nd element Absolute power at the reference area. Channel Integration Bandwidth
Start(Hz)	Start frequency for offset
Stop(Hz)	Stop frequency for offset
Meas BW(Hz)	Measurement bandwidth for offset
Lower Peak(dBc)	Relative peak power on minimum margin point of the negative offset
Lower Lim(dB)	Minimum margin from limit line which is decided by Fail Mask setting on the negative offset
Lower Freq(Hz)	Frequency on minimum margin point of the negative offset
Upper Peak(dBc)	Relative peak power on minimum margin point of the positive offset
Upper Lim(dB)	Minimum margin from limit line which is decided by Fail Mask setting on the positive offset
Upper Freq(Hz)	Frequency on minimum margin point of the positive offset

Rel Peak Pwr & Freq (PSD Ref)

This view consists of the following two windows:

[“Trace Window” on page 579](#)

[“Results Window” on page 579](#)

Spectrum Emission Mask Measurement
View/Display

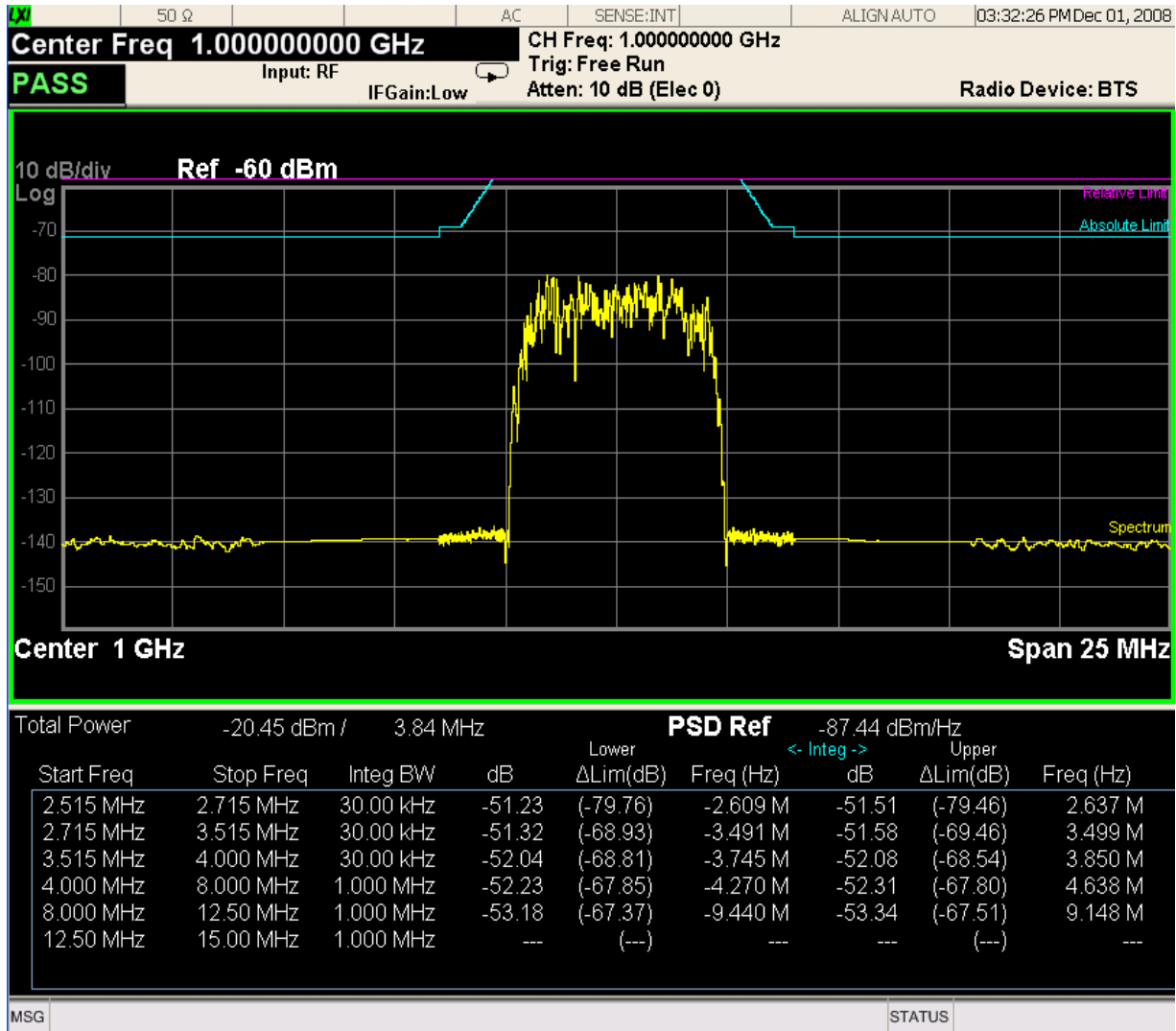

Trace Window

Corresponding Trace yellow - Combined trace from carrier and each offset

Results Window

Name	Corresponding Results
Total Pwr	n=1 2nd element Absolute power at the reference area. Channel Integration Bandwidth
PSD Ref	n=5 1st element Power spectral density reference at the reference area
Start(Hz)	Start frequency for offset
Stop(Hz)	Stop frequency for offset
Meas BW(Hz)	Measurement bandwidth for offset
Lower(dB)	Relative power spectrum density of the negative offset
Lower Lim(dB)	Minimum margin from limit line which is decided by Fail Mask setting on the negative offset
Lower Freq(Hz)	Frequency on minimum margin point of the negative offset
Upper(dB)	Relative power spectrum density of the positive offset
Upper Lim(dB)	Minimum margin from limit line which is decided by Fail Mask setting on the positive offset
Upper Freq(Hz)	Frequency on minimum margin point of the positive offset

Rel Peak Pwr & Freq (Spectrum Pk Ref)

This view consists of the following two windows:

“Trace Window” on page 577

“Results Window” on page 577

Spectrum Emission Mask Measurement
View/Display

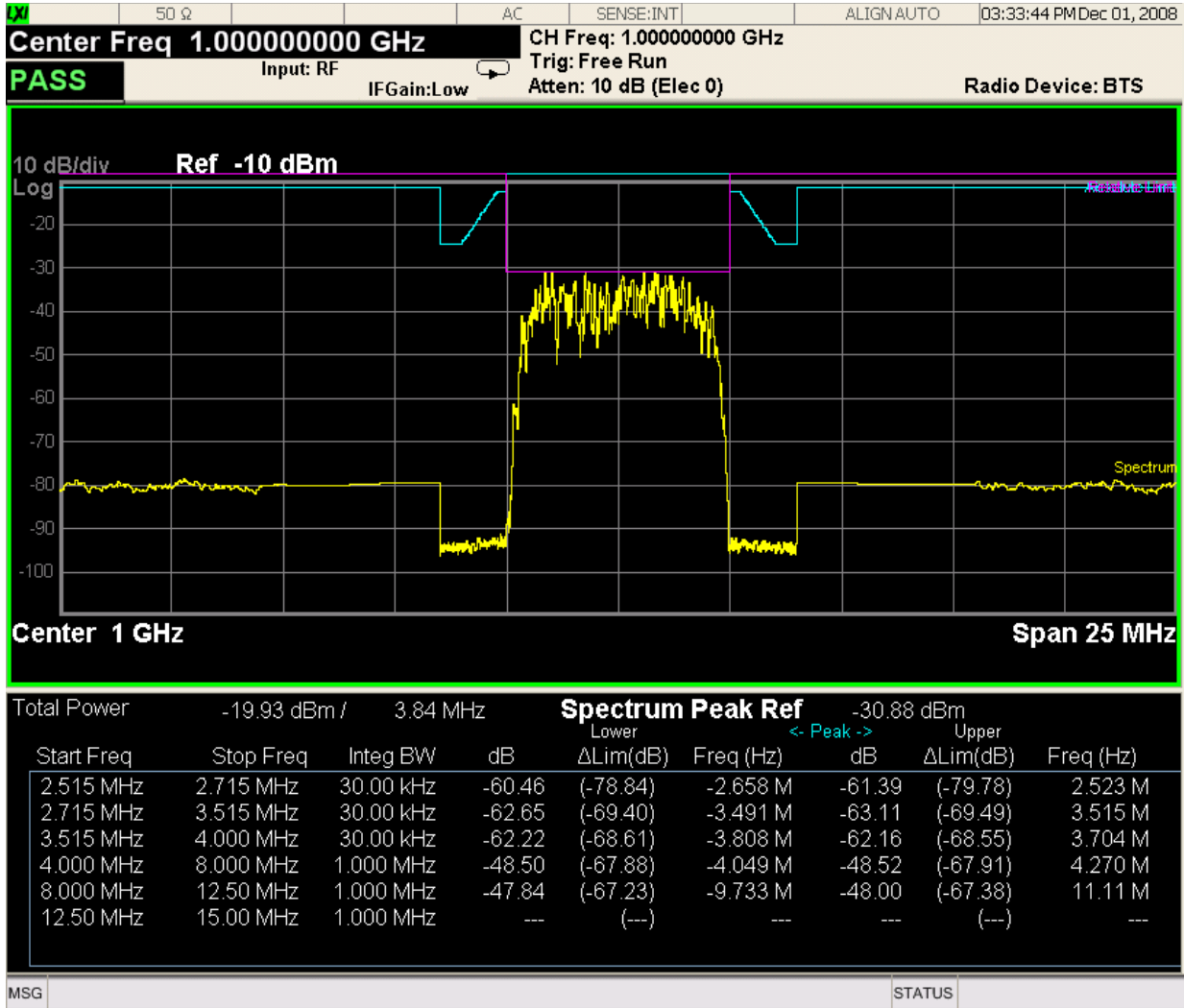

Trace Window

Corresponding Trace yellow - Combined trace from carrier and each offset

Results Window

Name	Corresponding Results
Total Pwr	Absolute power at the reference area. Channel Integration Bandwidth
Spectrum Peak Ref	n=5 1st element Spectrum peak power reference at the reference area
Start(Hz)	Start frequency for offset
Stop(Hz)	Stop frequency for offset
Meas BW(Hz)	Measurement bandwidth for offset
Lower Peak(dB)	Relative peak power on minimum margin point of the negative offset
Lower Lim(dB)	Minimum margin from limit line which is decided by Fail Mask setting on the negative offset
Lower Freq(Hz)	Frequency on minimum margin point of the negative offset
Upper Peak(dB)	Relative peak power on minimum margin point of the positive offset
Upper Lim(dB)	Minimum margin from limit line which is decided by Fail Mask setting on the positive offset
Upper Freq(Hz)	Frequency on minimum margin point of the positive offset
Key Path	View/Display
Instrument S/W Revision	Prior to A.02.00

Integrated Power

Integrated Power (Total Pwr Ref)

[“Trace Window” on page 583](#)

[“Results Window” on page 583](#)

Spectrum Emission Mask Measurement
View/Display

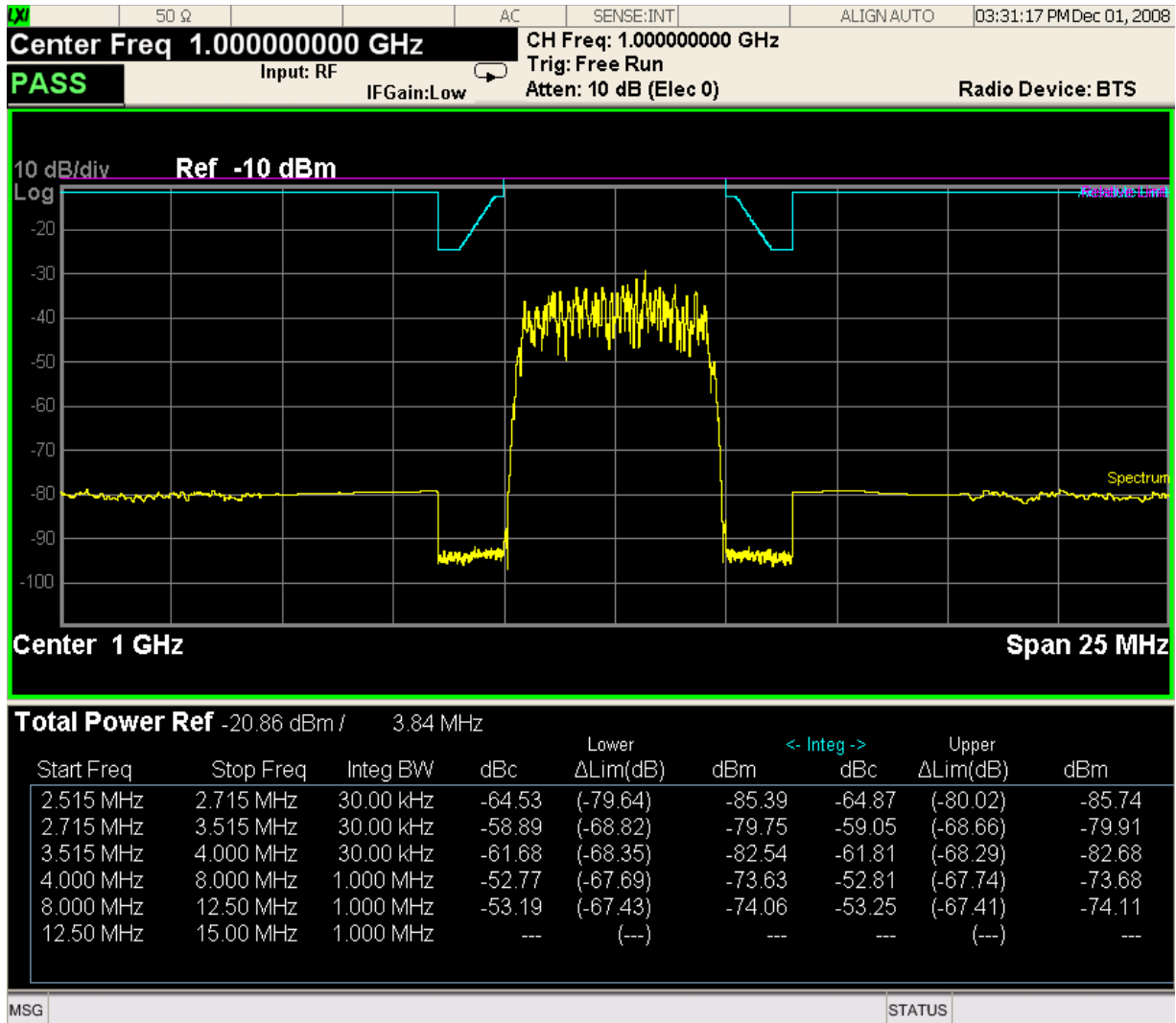

Trace Window

Corresponding Trace yellow - Combined trace from carrier and each offset

Results Window

Name	Corresponding Results
Total Pwr Ref	n=1 2nd element Absolute power at the reference area. Channel Integration Bandwidth
Start(Hz)	Start frequency for offset
Stop(Hz)	Stop frequency for offset
Meas BW(Hz)	Measurement bandwidth for offset
Lower Integ(dBc)	Relative integrated power on the negative offset
Lower Lim(dB)	Minimum margin from limit line which is decided by Fail Mask setting on the negative offset
Lower Integ(dBm)	Absolute integrated power on the negative offset
Upper Integ(dBc)	Relative integrated power on the positive offset
Upper Lim(dB)	Minimum margin from limit line which is decided by Fail Mask setting on the positive offset
Upper Integ(dBm)	Absolute integrated power on the positive offset

Integrated Power (PSD Ref)

[“Trace Window” on page 585](#)

[“Results Window” on page 585](#)

Spectrum Emission Mask Measurement
View/Display

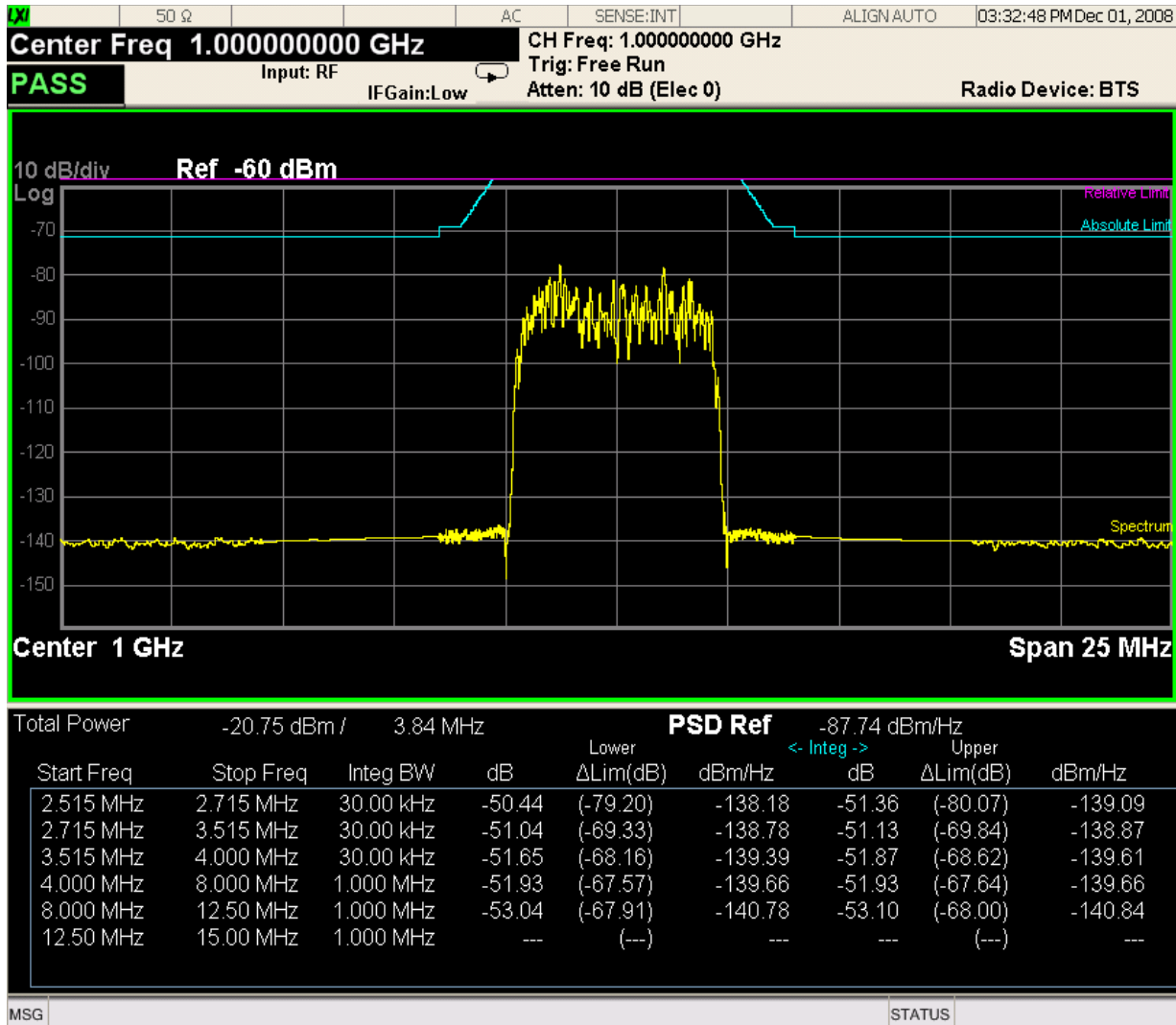

Trace Window

Corresponding Trace yellow - Combined trace from carrier and each offset

Results Window

Name	Corresponding Results
Total Pwr	n=1 2nd element Absolute power at the reference area. Channel Integration Bandwidth
PSD Ref	n=5 1st element Power spectral density reference at the reference area
Start(Hz)	Start frequency for offset
Stop(Hz)	Stop frequency for offset
Meas BW(Hz)	Measurement bandwidth for offset
Lower(dB)	Relative power spectrum density of the negative offset
Lower Lim(dB)	Minimum margin from limit line which is decided by Fail Mask setting on the negative offset
Lower(dBm/Hz)	Absolute power spectrum density of the negative offset
Upper(dB)	Relative power spectrum density of the positive offset
Upper Lim(dB)	Minimum margin from limit line which is decided by Fail Mask setting on the positive offset
Upper(dBm/Hz)	Absolute power spectrum density of the negative offset

Integrated Power (Spectrum Pk Ref)

[“Trace Window” on page 583](#)

[“Results Window” on page 583](#)

Spectrum Emission Mask Measurement
View/Display

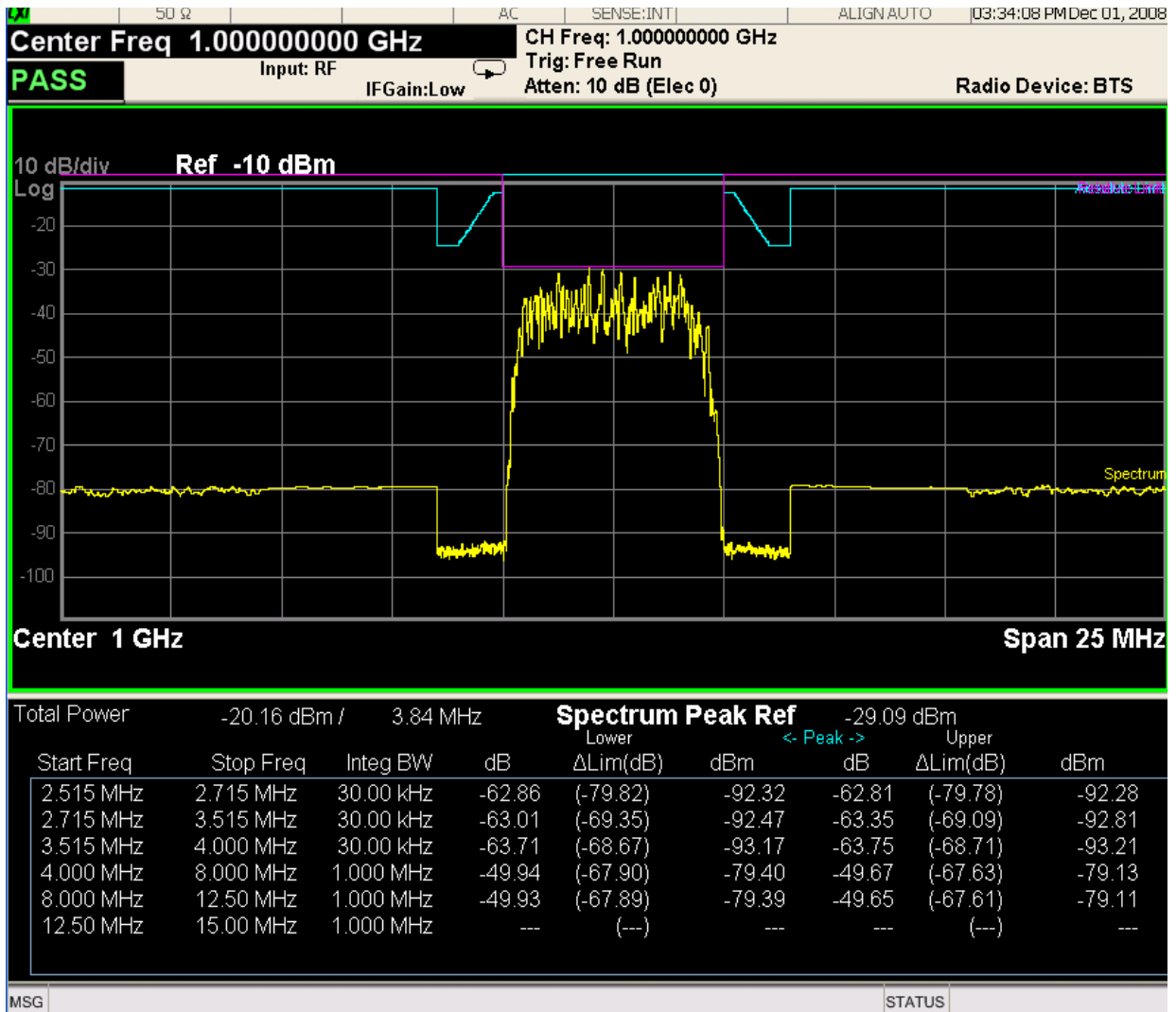

Trace Window

Corresponding Trace yellow - Combined trace from carrier and each offset

Results Window

Name	Corresponding Results
Total Pwr	Absolute power at the reference area. Channel Integration Bandwidth
Spectrum Peak Ref	n=5 1st element Peak power at the reference area
Start(Hz)	Start frequency for offset
Stop(Hz)	Stop frequency for offset
Meas BW(Hz)	Measurement bandwidth for offset
Lower Peak(dB)	Relative peak power on minimum margin point of the negative offset
Lower lim(dB)	Minimum margin from limit line which is decided by Fail Mask setting on the negative offset
Lower Peak(dBm)	Absolute peak power on minimum margin point of the negative offset
Upper Peak(dB)	Relative peak power on minimum margin point of the positive offset
Upper lim(dB)	Minimum margin from limit line which is decided by Fail Mask setting on the positive offset
Upper Peak(dBm)	Absolute peak power on minimum margin point of the positive offset

Key Path **View/Display**

Instrument S/W Revision Prior to A.02.00

Limit Lines

Toggles the limit lines display function for the spectrum emission mask measurements On and Off.

Remote Command :CALCulate:SEMask:LLINe:STATe ON|OFF|1|0
 :CALCulate:SEMask:LLINe:STATe?

Example CALC:SEM:LLIN:STAT OFF
 CALC:SEM:LLIN:STAT?

Spectrum Emission Mask Measurement View/Display

Key Path	View/Display
Mode	SA, WCDMA, C2K, WIMAX OFDMA, TD-SCDMA, 1xEVDO, DTMB, DVB-T/H
Notes	You must be in the Spectrum Analysis mode, W-CDMA mode, cdma2000 mode, TD-SCDMA mode, DTMB mode, DVB-T/H mode, 1xEVDO mode or WIMAX OFDMA mode to use this command. Use :INSTrument:SElect to set the mode.
Preset	ON
State Saved	Saved in instrument state.
Range	On Off
Instrument S/W Revision	Prior to A.02.00

The Spurious Emissions measurement identifies and determines the power level of spurious emissions in certain frequency bands. For measurement results and views, see [“View/Display” on page 654](#).

This topic contains the following sections:

[“Measurement Commands for Spurious Emissions” on page 589](#)

[“Remote Command Results for Spurious Emissions Measurement” on page 589](#)

Measurement Commands for Spurious Emissions

The following commands can be used to retrieve the measurement results:

```
:CONFigure:SPURious
:CONFigure:SPURious:NDEFault
:INITiate:SPURious
:FETCh:SPURious[n]?
:READ:SPURious[n]?
:MEASure:SPURious[n]?
```

For more measurement related commands, see the SENSE subsystem, and the section [“Remote Measurement Functions” on page 1127](#).

Remote Command Results for Spurious Emissions Measurement

Command	Return Value
CONFigure:SPURious	N/A
INITiate:SPURious	
FETCh:SPURious [n]?	n = 1 (or not supplied)
MEASure:SPURious [n]?	Returns a variable-length (1+6*Spurs – up to 1201 entries) comma separated list containing detailed information in the following format:
READ:SPURious [n]?	Number of spurs in following list (Integer)
(Note – these commands are not available when viewing the Range Table)	[Repeat the following for each spur]
	Spur #
	Range # Spur was located (Integer)
	Frequency of Spur (Hz, Float64)
	Amplitude of Spur (dBm, Float32)
	Absolute Limit (dBm, Float32)
	Pass or Fail (1 0, Boolean)

Spurious Emissions Measurement

n = 2 – 21

Returns a comma separated list of the trace data for the selected range (where range number = n – 1) using Detector 1. If selected range is not active SCPI_NAN is returned for each trace data element where SCPI_NAN = 9.91E37.

n = 22

Returns the number of spurs found.

n = 23 – 42

Returns a comma separated list of the trace data for the selected range (where range number = n – 22) using Detector 2. If selected range is not active or Detector 2 selection is off, SCPI_NAN is returned for each trace data element where SCPI_NAN = 9.91E37.

Key Path

Meas

Instrument S/W Revision

Prior to A.02.00

AMPTD Y Scale

AMPTD Y Scale opens a menu of functions that enable you to modify the Amplitude parameters.

Key Path	Front-panel key
Instrument S/W Revision	Prior to A.02.00

Ref Value

Sets the value for the absolute power reference. When Auto Scaling for the Y-axis is off, the measurement uses the current reference level settings. When Auto Scaling for the Y-axis is on, the analyzer will set the reference level such that the absolute limit will be positioned two divisions down from the top of the display.

Key Path	AMPTD/Y Scale
Mode	SA, WCDMA, WIMAX OFDMA, TD-SCDMA,C2k, 1xEV-DO, DVB-T/H
Remote Command	:DISPlay:SPURious:VIEW[1]:WINDow[1]:TRACe:Y[:SCALE]:RLEVel < real> :DISPlay:SPURious:VIEW[1]:WINDow[1]:TRACe:Y[:SCALE]:RLEVel?
Example	DISP:SPUR:VIEW:WIND:TRAC:Y:RLEV -50 dBm DISP:SPUR:VIEW:WIND:TRAC:Y:RLEV?
Notes	You must be in the Spectrum Analysis mode, W-CDMA mode, cdma2000 mode, DVB-T/H mode, TD-SCDMA mode or WiMAX mode to use this command. Use INSTRument:SElect to set the mode.
Dependencies/Couplings	When the Y Auto Scaling is off, the measurement uses the current reference level settings. When the Y Auto Scaling is on, the analyzer automatically sets the reference level such that the absolute limit is positioned two divisions down from the top of the display. This is the most useful setting when searching for spurs. The algorithm used for determining the ref level is Ref Level = Absolute Limit + (2 * Scale/Div). All other reference level settings are left as the current base instrument settings.
Preset	0.00 dBm
State Saved	Saved in instrument state.
Min	-250.0 dBm
Max	250.0 dBm
Instrument S/W Revision	Prior to A.02.00

Attenuation

This menu controls both the electrical and mechanical attenuators and their interactions. The value read back on the key in square brackets is the current Total (Elec + Mech) attenuation. When in Pre-Adjust for Min Clip mode, this value can change at the start of every measurement.

See “Attenuation” on page 1037 under AMPTD Y Scale in the “Common Measurement Functions” section for more information.

Key Path	AMPTD Y Scale
Instrument S/W Revision	Prior to A.02.00

Scale/Div

Sets the units per division of the vertical scale in the logarithmic display. However, since the Auto Scaling is defaulted to On, this value is automatically determined by the measurement result. When you set a value manually, Auto Scaling automatically changes to Off.

Key Path	AMPTD/Y Scale
Mode	SA, WCDMA, C2K, WIMAX OFDMA, TD-SCDMA, DVB-T/H
Remote Command	:DISPlay:SPURious:VIEW[1]:WINDow[1]:TRACe:Y[:SCALE]:PDI Vision <rel_ampl> :DISPlay:SPURious:VIEW[1]:WINDow[1]:TRACe:Y[:SCALE]:PDI Vision?
Example	DISP:SPUR:VIEW:WIND:TRAC:Y:PDIV 10 dB DISP:SPUR:VIEW:WIND:TRAC:Y:PDIV?
Notes	You must be in the Spectrum Analysis mode, W-CDMA mode, cdma2000 mode, DVB-T/H mode, TD-SCDMA or WiMAX mode to use this command. Use INSTRument:SELEct to set the mode.
Dependencies/Couplings	When the Scale Coupling is On, this value is automatically determined by the measurement result. When you set a value manually, Scale Coupling automatically changes to Off.
Preset	10.00 dB
State Saved	Saved in instrument state.
Range	0.10 dB to 20.00 dB
Instrument S/W Revision	Prior to A.02.00

Presel Center

See AMPTD Y Scale, “Presel Center” on page 1049 in the “Common Measurement Functions” section for more information.

Presel Adjust

See AMPTD Y Scale, “[Preselector Adjust](#)” on page 1050 in the “Common Measurement Functions” section for more information.

Internal Preamp

Accesses a menu that enables you to control the internal preamplifiers. Turning Internal Preamp on gives a better noise figure, but a poorer inter-modulation distortion (TOI) to noise floor dynamic range. You can optimize this setting for your particular measurement.

See “[Internal Preamp](#)” on page 1052 under AMPTD Y Scale in the "Common Measurement Functions" section for more information.

Key Path	AMPTD Y Scale
Instrument S/W Revision	Prior to A.02.00

Auto Scaling

Toggles the Auto Scaling function between On and Off.

Key Path	AMPTD Y Scale
Mode	SA, WCDMA, C2K, WIMAX OFDMA, TD-SCDMA, DVB-T/H
Remote Command	:DISPlay:SPURious:VIEW[1]:WINDow[1]:TRACe:Y[:SCALE]:COUPle 0 1 OFF ON :DISPlay:SPURious:VIEW[1]:WINDow[1]:TRACe:Y[:SCALE]:COUPle?
Example	DISP:SPUR:VIEW:WIND:TRAC:Y:COUP OFF DISP:SPUR:VIEW:WIND:TRAC:Y:COUP?
Dependencies/Couplings	When Auto Scaling is On and the Restart front-panel key is pressed, this function automatically determines the scale per division and reference values based on the measurement results. When you set a value to either Scale/Div or Ref Value manually, Auto Scaling automatically changes to Off. When the Y Auto Scaling is off, the measurement uses the current reference level settings. When the Y Auto Scaling is on, the analyzer automatically sets the reference level such that the absolute limit is positioned two divisions down from the top of the display. This is the most useful setting when searching for spurs. The algorithm used for determining the ref level is Ref Level = Absolute Limit + (2 * Scale/Div). All other reference level settings are left as the current base instrument settings.
Preset	1
State Saved	Saved in instrument state.
Range	On Off

Spurious Emissions Measurement
AMPTD Y Scale

Instrument S/W Revision

Prior to A.02.00

Auto Couple

See “**AUTO COUPLE**” on page 1055 in the section "Common Measurement Functions" for more information.

BW

BW is unavailable in the Spurious Emissions measurement.

Key Path

Front-panel key

Instrument S/W Revision

Prior to A.02.00

Cont

See “[Cont \(Continuous Measurement/Sweep\)](#)” on page 1059 in the section "Common Measurement Functions" for more information.

Frequency/Channel

Frequency/Channel is unavailable in the Spurious Emissions measurement.

Key Path

Front-panel key

Instrument S/W Revision

Prior to A.02.00

Input/Output

See “[Input/Output](#)” on page 1065 in the section "Common Measurement Functions" for more information.

Marker

Displays the menu keys that enable you to select, set up and control the markers for the current measurement.

Key Path	Front-panel key
Instrument S/W Revision	Prior to A.02.00

Select Marker

Displays 12 markers available for selection.

Key Path	Marker
Instrument S/W Revision	Prior to A.02.00

Marker Type

Sets the marker control mode to **Normal**, **Delta** and **Off**. Normal enables you to activate the selected marker to read the power level and time. Delta enables you to read the differences in the power levels and time scales between the selected marker and the next marker. Off enables you to turn off the selected marker.

All interactions and dependencies detailed under the key description are enforced when the remote command is sent.

Key Path	Marker
Mode	SA, WCDMA, C2K, WIMAX OFDMA, TD-SCDMA, 1xEV-DO, DVB-T/H
Remote Command	:CALCulate:SPURious:MARKer[1] 2 3 4 5 6 7 8 9 10 11 12: MODE POSition DELTA OFF :CALCulate:SPURious:MARKer[1] 2 3 4 5 6 7 8 9 10 11 12: MODE?
Example	CALC:SPUR:MARK:MODE POS CALC:SPUR:MARK:MODE?

Notes	<p>If the selected marker is Off, pressing Marker sets it to Normal and places it at the center of the screen on the trace determined by the Marker Trace rules. At the same time, Marker X Axis Value appears on the Active Function area.</p> <p>Default Active Function: the active function for the selected marker's current control mode. If the current control mode is Off, there is no active function and the active function is turned off.</p> <p>Active Function Display: the marker X axis value entered in the active function area will display the marker value to its full entered precision.</p> <p>You must be in the cdma2000 mode, 1xEV-DO mode, TD-SCDMA mode, W-CDMA mode, DVB-T/H mode, GSM/EDGE mode or WiMAX mode to use this command. Use INSTRument:SElect to set the mode.</p>
Dependencies/Couplings	No
Preset	=OFF
State Saved	Saved in instrument state.
Range	Normal Delta Off
Instrument S/W Revision	Prior to A.02.00

Marker X Axis Value (Remote Command only)

Sets the Marker X Axis value in the current marker X Axis Scale unit. It has no effect if the control mode is **Off**, but is the SCPI equivalent of entering an X value if the control mode is **Normal** or **Delta**.

Mode	SA, WCDMA, C2K, WIMAX OFDMA, TD-SCDMA, DVB-T/H
Remote Command	<pre>:CALCulate:SPURious:MARKer[1] 2 3 4 5 6 7 8 9 10 11 12: X <freq> :CALCulate:SPURious:MARKer[1] 2 3 4 5 6 7 8 9 10 11 12: X?</pre>
Example	<pre>CALC:SPUR:MARK2:X 25 kHz CALC:SPUR:MARK3:X?</pre>
Notes	<p>If no suffix is sent it will use the fundamental units for the current marker X Axis Scale. If a suffix is sent that does not match the current marker X Axis Scale unit, an error "Invalid suffix" will be generated.</p> <p>The query returns the absolute X Axis marker value if the control mode is Normal, or the offset from the reference marker if the control mode is Delta. The query is returned in the fundamental units for the current marker X Axis scale: Hz for Frequency and Inverse Time, seconds for Period and Time. If the marker is Off, the response is not a number.</p>
Preset	1 GHz
State Saved	No
Min	-9.9E+37

Spurious Emissions Measurement Marker

Max	9.9E+37
Instrument S/W Revision	Prior to A.02.00

Marker X Axis Position (Remote Command only)

Sets the Marker X position in trace points. It has no effect if the control mode is **Off**, but is the SCPI equivalent of entering a value if the control mode is **Normal** or **Delta** - except in trace points rather than X Axis Scale units. The entered value is immediately translated into the current X Axis Scale units for setting the value of the marker.

Mode	SA, WCDMA, C2K, WIMAX OFDMA, TD-SCDMA, 1xEV-DO, DVB-T/H
Remote Command	:CALCulate:SPURious:MARKer[1] 2 3 4 5 6 7 8 9 10 11 12: X:POSition <integer> :CALCulate:SPURious:MARKer[1] 2 3 4 5 6 7 8 9 10 11 12: X:POSition?
Example	CALC:SPUR:MARK10:X:POS?
Notes	The query returns the absolute X Axis marker value in trace points if the control mode is Normal , or the offset from the reference marker in trace points if the control mode is Delta . The value is returned as a real number, not an integer, corresponding to the translation from X Axis Scale units to trace points. If the marker is Off the response is not a number.
Preset	300
State Saved	No
Min	-9.9E+37
Max	9.9E+37
Instrument S/W Revision	Prior to A.02.00

Marker Y Axis Value (Remote Command only)

Returns the marker Y Axis value in the current marker Y Axis unit.

Mode	SA, WCDMA, C2K, WIMAX OFDMA, TD-SCDMA, 1xEV-DO, DVB-T/H
Remote Command	:CALCulate:SPURious:MARKer[1] 2 3 4 5 6 7 8 9 10 11 12: Y?
Example	CALC:SPUR:MARK11:Y?
Notes	If no suffix is sent, it will use the current Y Axis unit. If a suffix is sent that does not have units of absolute amplitude, an error "Invalid suffix" will be generated.
Preset	Depends on Y axis range of selected Trace.

State Saved	No
Instrument S/W Revision	Prior to A.02.00

Properties

Accesses the Properties menu to set certain properties of the selected marker.

Key Path	Marker
Instrument S/W Revision	Prior to A.02.00

Select Marker

Displays 12 markers available for selection.

Key Path	Marker
Instrument S/W Revision	Prior to A.02.00

Relative To

Selects the marker the selected marker will be relative to (its reference marker).

Every marker has another marker to which it is relative. This marker is referred to as the "reference marker" for that marker. This attribute is set by the **Marker, Properties, Relative To** key. The marker must be a **Delta** marker to make this attribute relevant. If it is a **Delta** marker, the reference marker determines how the marker is controlled and how its value is displayed. A marker cannot be relative to itself.

Key Path	Marker, Properties
Mode	SA, WCDMA, C2K, WIMAX OFDMA, TD-SCDMA, 1xEV-DO, DVB-T/H
Remote Command	:CALCulate:SPURious:MARKer[1] 2 3 4 5 6 7 8 9 10 11 12: REFERENCE <integer> :CALCulate:SPURious:MARKer[1] 2 3 4 5 6 7 8 9 10 11 12: REFERENCE?
Example	CALC:SPUR:MARK3:REF 5 CALC:SPUR:MARK:REF?
Notes	A marker cannot be relative to itself so that choice is grayed out, and if sent from SCPI generates error -221: "Settings conflict; marker cannot be relative to itself." When queried a single value will be returned (the specified marker numbers relative marker). You must be in the Spectrum Analysis mode, GSM mode or WiMAX mode or TD-SCDMA mode to use this command. Use INSTRUMENT:SElect to set the mode.

Spurious Emissions Measurement Marker

Preset	2 3 4 5 6 7 8 9 10 11 12 1
State Saved	Saved in instrument state.
Min	1
Max	12
Instrument S/W Revision	Prior to A.02.00

Couple Markers

When this function is true, moving any marker causes an equal X Axis movement of every other marker which is not **Off**. By “equal X Axis movement” we mean that we preserve the difference between each marker’s X Axis value (in the fundamental x-axis units of the trace that marker is on) and the X Axis value of the marker being moved (in the same fundamental x-axis units).

Key Path	Marker
Mode	SA, WCDMA, C2K, WIMAX OFDMA, TD-SCDMA, 1xEV-DO, DVB-T/H
Remote Command	:CALCulate:SPURious:MARKer:COUPle[:STATe] ON OFF 1 0 :CALCulate:SPURious:MARKer:COUPle[:STATe]?
Example	CALC:SPUR:MARK:COUP ON CALC:SPUR:MARK:COUP?
Preset	OFF
State Saved	Saved in instrument state.
Range	On Off
Instrument S/W Revision	Prior to A.02.00

All Markers Off

Turns off all markers.

Key Path	Marker
Mode	SA, WCDMA, C2K, WIMAX OFDMA, TD-SCDMA, 1xEV-DO, DVB-T/H
Remote Command	:CALCulate:SPURious:MARKer:AOFF
Example	CALC:SPUR:MARK:AOFF
Instrument S/W Revision	Prior to A.02.00

Marker Function

There are no 'Marker Functions' supported in Spurious Emissions so this front-panel key will display a blank menu key when pressed.

Key Path	Front-panel key
Instrument S/W Revision	Prior to A.02.00

Marker To

There is no 'Marker To' functionality supported in Spurious Emissions so this front-panel key will display a blank menu key when pressed.

Key Path	Front-panel key
Instrument S/W Revision	Prior to A.02.00

Meas

See “[Meas](#)” on page 1127 in the section "Common Measurement Functions" for more information.

Meas Setup

Displays the measurement setup menu for the currently selected measurement.

Key Path	Front-panel key
Instrument S/W Revision	Prior to A.02.00

Avg/Hold Num

Specifies the number of measurement averages used to calculate the measurement result. The average is displayed at the end of each sweep.

Average State allows you to turn averaging On or Off.

Key Path	Meas Setup
Mode	SA, WCDMA, C2K, WIMAX OFDMA, CDMA1xEVDO, TD-SCDMA, DVB-T/H
Remote Command	<pre>[:SENSe]:SPURious:AVERAge:COUNT <integer> [:SENSe]:SPURious:AVERAge:COUNT? [:SENSe]:SPURious:AVERAge[:STATe] ON OFF 1 0 [:SENSe]:SPURious:AVERAge[:STATe]?</pre>
Example	<pre>SPUR:AVER:COUN 2500 SPUR:AVER:COUN? SPUR:AVER ON SPUR:AVER?</pre>
Notes	You must be in the Spectrum Analysis mode, W-CDMA mode, cdma2000 mode, DVB-T/H mode, TD-SCDMA mode or WiMAX mode to use this command. Use INSTRument:SElect to set the mode.
Preset	10 OFF
State Saved	Saved in instrument state.
Min	1
Max	10000
Instrument S/W Revision	Prior to A.02.00

Avg Mode

Enables you to set the averaging mode.

When set to Exponential (Exp) the measurement averaging continues using the specified number of averages to compute each averaged value. The average will be displayed at the end of each sweep.

When set to Repeat, the measurement resets the average counter each time the specified number of averages is reached.

Key Path	Meas Setup
Mode	SA, WCDMA, WIMAX OFDMA, TD-SCDMA, DVB-T/H
Remote Command	[:SENSe] :SPURious:AVERage:TCONtrol EXPonential REPeat [:SENSe] :SPURious:AVERage:TCONtrol?
Example	SPUR:AVER:TCON REP SPUR:AVER:TCON?
Notes	You must be in the cdma2000 mode, TD-SCDMA mode, W-CDMA mode, DVB-T/H mode, GSM/EDGE mode or WiMAX mode to use this command. Use INSTRument:SElect to set the mode.
Preset	EXPonential
State Saved	Saved in instrument state.
Range	Exp Repeat
Instrument S/W Revision	Prior to A.02.00

Range Table

The range table is used to enter the settings for up to twenty ranges.

Upon entering the range table (front panel only) the measurement is stopped and the analyzer is set to a constantly sweeping idle state. The analyzer will be set to the current values of range 1, regardless if it is on or off. If a range is outside the values in the current range table for that range, "---" will appear to indicate this range is currently inactive.

To change a parameter, select the appropriate menu key and enter the value using the numeric keypad, or the knob. The analyzer settings will be updated with the new parameter values. Although no measurements are being made, this allows you to preview the range they will be measuring.

If the range is changed, the analyzer will change its settings to reflect the currently selected range. The selected range will be displayed on the last line of the range table view unless; the selected range is 5 or less in the normal range table view. In this case, the first 5 entries of the range table will be displayed and the zoom mode is selected. In the zoom mode all 20 ranges can be displayed.

Key Path	Meas Setup
Instrument S/W Revision	Prior to A.02.00

Range

Changing the range will update the values on the other menu keys so that they reflect the settings for the selected range. If Range is turned on, it will be used as part of the measurement. If it is off, it will be

Remote Command	<pre>[:SENSe]:SPURious[:RANGe][:LIST]:FREQuency:STARt <freq>, <freq>, <freq>, <freq>, <freq>, <freq>, <freq>, <freq>, <freq>, <freq>, <freq>, <freq>, <freq>, <freq>, <freq>, <freq>, <freq>, <freq>, <freq>, <freq> [:SENSe]:SPURious[:RANGe][:LIST]:FREQuency:STARt?</pre>
Example	<pre>SPUR:FREQ:STAR 9 kHz, 150 kHz, 30 MHz, 1GHz, 1.5 GHz, 1.5 GHz, 1.5 GHz, 1.5 GHz,1.5 GHz,1.5 GHz,1.5 GHz,1.5 GHz,1.5 GHz,1.5 GHz,1.5 GHz,1.5 GHz,1.5 GHz,1.5 GHz,1.5 GHz,1.5 GHz SPUR:FREQ:STAR?</pre>
Notes	You must be in cdma2000 mode, TD-SCDMA mode, W-CDMA mode, DVB-T/H, GSM/EDGE mode or WiMAX mode to use this command. Use INSTRument:SElect to set the mode.
Preset	<pre>SA, WIMAX OFDMA:+1.92000000E+009,+1.89350000E+009,+2.10000000E+009,+2.17 500000E+009,+8.00000000E+008,+1.50000000E+009,+1.50000000E+009,+ 1.50000000E+009,+1.50000000E+009,+1.50000000E+009,+1.50000000E+0 09,+1.50000000E+009,+1.50000000E+009,+1.50000000E+009,+1.500000 00E+009,+1.50000000E+009,+1.50000000E+009,+1.50000000E+009,+1.500 00000E+009,+1.50000000E+009 WCDMA:9kHz,150kHz,30MHz,1GHz,2.1GHz,2.1GHz,2.1774GHz,2.18GH z,1.5GHz,1.5GHz,1.5GHz,1.5GHz,1.5GHz,1.5GHz,1.5GHz,1.5GHz, 1.5GHz,1.5GHz,1.5GHz,1.5GHz,1.5GHz C2K,1xEV-DO: 9kHz, 150kHz, 30 MHz, 1GHz, 2.5GHz, 2.5GHz, 2.5GHz , 2.5 GHz, 2.5 GHz, 2.5 GHz, 2.5 GHz, 2.5 GHz, 2.5 GHz, 2.5 GHz, 2.5 GHz, 2.5 GHz, 2.5 GHz, 2.5 GHz, 2.5 GHz TD-SCDMA: 9 kHz, 150 kHz, 30 MHz, 1GHz, 1.5 GHz, 1.5 GHz, 1.5 GHz, 1.5 GHz,1.5 GHz,1.5 GHz,1.5 GHz,1.5 GHz,1.5 GHz,1.5 GHz,1.5 GHz,1.5 GHz,1.5 GHz,1.5 GHz,1.5 GHz,1.5 GHz DVB-T/H: 9kHz, 174MHz, 400MHz, 790MHz, 862MHz, 1GHz, 1.5GHz, 1.5GHz, 1.5GHz, 1.5GHz, 1.5GHz, 1.5GHz, 1.5GHz, 1.5GHz, 1.5GHz, 1.5GHz, 1.5GHz, 1.5GHz, 1.5GHz, 1.5GHz</pre>
State Saved	Saved in instrument state.
Min	-80 MHz
Max	<pre>Hardware Dependent: Option 503: 3699999990 Option 508: 8499999990 Option 513: 13799999990 Option 526: 26999999990</pre>
Instrument S/W Revision	Prior to A.02.00

Min	-79999990
Max	Hardware Dependent: Option 503: 3.7 GHz Option 508: 8.5 GHz Option 513: 13.8 GHz Option 526: 27.0 GHz
Instrument S/W Revision	Prior to A.02.00

Res BW

Sets the resolution bandwidth of the analyzer. This parameter can send up to 20 values.

The location of where the resolution bandwidth occurs in the list sent to the measurement corresponds to the range the value is associated with.

Missing values are not permitted. In other words, if you want to change values 2 and 6 you must send all values up to 6. Subsequent values will remain as they were. The query for this parameter always returns 20 values.

Key Path	Meas Setup, Range Table
Mode	SA, WCDMA, C2K, WIMAX OFDMA, TD-SCDMA, 1xEV-DO, DVB-T/H
Remote Command	<pre>[:SENSE]:SPURious[:RANGE][:LIST]:BANDwidth[:RESolution] <freq>, <freq>, <freq>, <freq>, <freq>, <freq>, <freq>, <freq>, <freq>, <freq>, <freq>, <freq>, <freq>, <freq>, <freq>, <freq>, <freq>, <freq>, <freq>, <freq> [:SENSE]:SPURious[:RANGE][:LIST]:BANDwidth[:RESolution] ? [:SENSE]:SPURious[:RANGE][:LIST]:BANDwidth[:RESolution] :AUTO OFF ON 0 1, OFF ON 0 1, OFF ON 0 1, OFF ON 0 1, OFF ON 0 1, OFF ON 0 1, OFF ON 0 1, OFF ON 0 1, OFF ON 0 1, OFF ON 0 1, OFF ON 0 1, OFF ON 0 1, OFF ON 0 1, OFF ON 0 1, OFF ON 0 1, OFF ON 0 1, OFF ON 0 1, OFF ON 0 1, OFF ON 0 1, OFF ON 0 1 [:SENSE]:SPURious[:RANGE][:LIST]:BANDwidth[:RESolution] :AUTO?</pre>
Example	<pre>SPUR:BWND 1kHz,10kHz,100kHz,1MHz,1MHz,1MHz,1MHz, 3MHz,3MHz,3MHz,3MHz,3MHz,3MHz,3MHz,3MHz,3MHz,3MHz,3MHz,3MHz, 3MHz,3MHz SPUR:BWND? SPUR:BWID:AUTO ON, ON, ON, OFF, OFF, OFF, OFF, OFF, ON, ON, ON, ON, OFF, OFF, OFF, OFF, OFF, OFF, ON, ON SPUR:BWID:AUTO?</pre>

Spurious Emissions Measurement Meas Setup

under certain conditions. The **Filter Type** menu gives you control over these parameters.

Key Path	Meas Setup, Range Table
Mode	SA, WCDMA, C2K, WIMAX OFDMA, TD-SCDMA, 1xEV-DO, DVB-T/H
Remote Command	<pre>[:SENSe]:SPURious[:RANGe][:LIST]:BANDwidth:SHApe GAUSSian FLATtop, GAUSSian FLATtop, GAUSSian FLATtop, GAUSSian FLATtop, GAUSSian FLATtop, GAUSSian FLATtop, GAUSSian FLATtop, GAUSSian FLATtop, GAUSSian FLATtop, GAUSSian FLATtop, GAUSSian FLATtop, GAUSSian FLATtop, GAUSSian FLATtop, GAUSSian FLATtop, GAUSSian FLATtop, GAUSSian FLATtop, GAUSSian FLATtop, GAUSSian FLATtop, GAUSSian FLATtop, GAUSSian FLATtop</pre> <pre>[:SENSe]:SPURious[:RANGe][:LIST]:BANDwidth:SHApe?</pre>
Example	<pre>SPUR:BAND:SHAP GAUS, GAUS, GAUS, GAUS, GAUS, GAUS, FLAT, FLAT, FLAT, FLAT, FLAT, GAUS, GAUS, GAUS, GAUS, GAUS, FLAT, FLAT, GAUS, GAUS</pre> <pre>SPUR:BAND:SHAP?</pre>
Preset	GAUS, GAUS, GAUS, GAUS, GAUS, GAUS, GAUS, GAUS, GAUS, GAUS, GAUS, GAUS, GAUS, GAUS, GAUS, GAUS, GAUS, GAUS, GAUS
State Saved	Saved in instrument state.
Range	Gaussian (Normal) Flattop
Instrument S/W Revision	Prior to A.02.00

Abs Start Limit

Determines the limit above which spurs will report a failing. If Abs Stop Limit Mode is set to Auto, this is coupled to Abs Stop Limit to make a flat limit line. If set to Man, Abs Start Limit and Abs Stop Limit can take different values to make a sloped limit line.

If the Limit Line Test parameter is off then any spurs which are found to be above the current 'Peak Excursion' will be added to the results table. From these spurs, the amplitude will be checked using the abs limit start and abs limit stop parameters and then calculate the limit. An 'F' will be appended to the amplitude value of the spur if the measured amplitude is above the limit. If the Limit Line Test is on, only the spurs whose amplitudes exceed the limit will be reported.

This parameter can send up to 20 values. The location in the list sent corresponds to the range of the associated value. Missing values are not permitted. If you want to change values 2 and 6 you must sent all values up to 6. Subsequent values will remain as they were. The query for this parameter always returns 20 values.

Key Path	Meas Setup, Range Table
Mode	SA, WCDMA, C2K, WIMAX OFDMA, TD-SCDMA, 1xEV-DO, DVB-T/H

Spurious Emissions Measurement Meas Setup

associated value. Missing values are not permitted. If you want to change values 2 and 6 you must sent all values up to 6. Subsequent values will remain as they were. The query for this parameter always returns 20 values.

Abs Stop Limit Mode, when set to Couple, couples Abs Start Limit and Abs Stop Limit to make a flat limit line. If set to Man, Abs Start and Abs Stop can take different values to make a sloped limit line.

This parameter can send up to 20 values. The location in the list sent corresponds to the range of the associated value. Missing values are not permitted, in other words, if you want to change values 2 and 6 you must sent all values up to 6. Subsequent values will remain as they were. The query for this parameter always returns 20 values.

Key Path	Meas Setup, Range Table
Mode	SA, WCDMA, C2K, WIMAX OFDMA, TD-SCDMA, 1xEV-DO, DVB-T/H
Remote Command	<pre> :CALCulate:SPURious[:RANGe][:LIST]:LIMit:ABSolute[:UPPe r]:DATA:STOP <ampl>, <ampl>, <ampl>, <ampl>, <ampl>, <ampl>, <ampl>, <ampl>, <ampl>, <ampl>, <ampl>, <ampl>, <ampl>, <ampl>, <ampl>, <ampl>, <ampl>, <ampl>, <ampl>, <ampl> :CALCulate:SPURious[:RANGe][:LIST]:LIMit:ABSolute[:UPPe r]:DATA:STOP? :CALCulate:SPURious[:RANGe][:LIST]:LIMit:ABSolute[:UPPe r]:DATA:STOP:AUTO OFF ON 0 1, OFF ON 0 1, OFF ON 0 1, OFF ON 0 1, OFF ON 0 1, OFF ON 0 1, OFF ON 0 1, OFF ON 0 1, OFF ON 0 1, OFF ON 0 1, OFF ON 0 1, OFF ON 0 1, OFF ON 0 1, OFF ON 0 1, OFF ON 0 1, OFF ON 0 1, OFF ON 0 1, OFF ON 0 1, OFF ON 0 1, OFF ON 0 1 :CALCulate:SPURious[:RANGe][:LIST]:LIMit:ABSolute[:UPPe r]:DATA:STOP:AUTO? </pre>
Example	<pre> CALC:SPUR:LIM:ABS:DATA:STOP -25,-25,-25,-25,-25,-25,-25,-25,-25,-25,-25,-25,-25,-25,-25,-25,-25,-25,-25,-25 CALC:SPUR:LIM:ABS:DATA:STOP? CALC:SPUR:LIM:ABS:DATA:STOP:AUTO ON, ON, ON, ON, ON, ON, ON, ON, ON, ON, ON, ON, ON, ON, ON, ON, ON, ON, ON CALC:SPUR:LIM:ABS:DATA:STOP:AUTO? </pre>

Spurious Emissions Measurement Meas Setup

Remote Command	<pre>[:SENSe]:SPURious[:RANGe][:LIST]:PEAK:EXCursion <rel_ampl>, <rel_ampl>, <rel_ampl>, <rel_ampl>, <rel_ampl>, <rel_ampl>, <rel_ampl>, <rel_ampl>, <rel_ampl>, <rel_ampl>, <rel_ampl>, <rel_ampl>, <rel_ampl>, <rel_ampl>, <rel_ampl>, <rel_ampl>, <rel_ampl>, <rel_ampl>, <rel_ampl>, <rel_ampl> [:SENSe]:SPURious[:RANGe][:LIST]:PEAK:EXCursion?</pre>
Example	<pre>SPUR:PEAK:EXC 20,20, 20, 20, 20, 20, 20, 20, 20, 20, 20, 20, 20, 20, 20, 20, 20, 20, 20, 20 SPUR:PEAK:EXC?</pre>
Preset	<pre>+6.00000000E+000,+6.00000000E+000,+6.00000000E+000,+6.00000000E+ 000,+6.00000000E+000,+6.00000000E+000,+6.00000000E+000,+6.000000 00E+000,+6.00000000E+000,+6.00000000E+000,+6.00000000E+000,+6.00 000000E+000,+6.00000000E+000,+6.00000000E+000,+6.00000000E+000,+ 6.00000000E+000,+6.00000000E+000,+6.00000000E+000,+6.00000000E+0 00,+6.00000000E+000</pre>
State Saved	Saved in instrument state.
Min	0.0 dB
Max	100.0 dB
Instrument S/W Revision	Prior to A.02.00

Pk Threshold

Sets the minimum amplitude of signals that can be identified as peaks. For example, if a value of -90 dBm is selected, only peaks that rise and fall more than the peak excursion value which are above -90 dBm are identified. This parameter can send up to 20 values. The location in the list sent corresponds to the range of the associated value. Missing values are not permitted. If you want to change values 2 and 6 you must send all values up to 6. Subsequent values will remain as they were. The query for this parameter always returns 20 values.

Key Path	Meas Setup, Range Table
Mode	SA, WCDMA, C2K, WIMAX OFDMA, TD-SCDMA, 1xEV-DO, DVB-T/H
Remote Command	<pre>[:SENSe]:SPURious[:RANGe][:LIST]:PEAK:THREshold <real>, <real>, <real>, <real>, <real>, <real>, <real>, <real>, <real>, <real>, <real>, <real>, <real>, <real>, <real>, <real>, <real>, <real>, <real>, <real> [:SENSe]:SPURious[:RANGe][:LIST]:PEAK:THREshold?</pre>
Example	<pre>SPUR:PEAK:THR 0,0,0 SPUR:PEAK:THR?</pre>

Points

Sets the number of points per sweep for the measurement. This parameter can send up to 20 values. The location in the list sent corresponds to the range of the associated value. Missing values are not permitted. If you want to change values 2 and 6 you must send all values up to 6. Subsequent values will remain as they were. The query for this parameter always returns 20 values.

The Points mode can be manual, where you determine the setting or auto, where the analyzer determines the number of trace points to ensure the sweep points resolution equals RBW/2. This is calculated using the following algorithm:

$Points = (Stop\ Freq - Start\ Freq) / (ResBW / 2)$, with the computed values being clipped to a minimum of 601 and a maximum of 20001.

This parameter can send up to 20 values. The location in the list sent corresponds to the range the value is associated with. Missing values are not permitted, in other words, if you want to change values 2 and 6 you must send all values up to 6. Subsequent values will remain as they were. The query for this parameter always returns 20 values.

Key Path	Meas Setup, Range Table
Mode	SA, WCDMA, C2K, WIMAX OFDMA, TD-SCDMA, 1xEV-DO, DVB-T/H
Remote Command	<pre>[:SENSe]:SPURious[:RANGe][:LIST]:SWEep:POINts <integer> [:SENSe]:SPURious[:RANGe][:LIST]:SWEep:POINts? [:SENSe]:SPURious[:RANGe][:LIST]:SWEep:POINts:AUTO OFF ON 0 1, OFF ON 0 1, OFF ON 0 1, OFF ON 0 1, OFF ON 0 1, OFF ON 0 1, OFF ON 0 1, OFF ON 0 1, OFF ON 0 1, OFF ON 0 1, OFF ON 0 1, OFF ON 0 1, OFF ON 0 1, OFF ON 0 1, OFF ON 0 1, OFF ON 0 1, OFF ON 0 1, OFF ON 0 1, OFF ON 0 1, OFF ON 0 1 [:SENSe]:SPURious[:RANGe][:LIST]:SWEep:POINts:AUTO?</pre>
Example	<pre>SPUR:SWE:POIN 1001,1001,1001 SPUR:SWE:POIN? SPUR:SWE:POIN:AUTO ON,ON,ON SPUR:SWE:POIN:AUTO?</pre>
Notes	:

Spurious Emissions Measurement Meas Setup

Preset	SA, WIMAX OFDMA, DVB-T/H: +601, 01,+601,+601,+601,+601,+601,+601 WCDMA: 601,2985,9700,1100,601,601,601,10570,601,601,601,601,601,601,601,601,601,601,601,601,601,601,601, 01,601,601,601 C2K: 601,601,9970,11750,,601,601,601,601,601,601,601,601,601,601,601,601,601,601,601,601,601,601,601, ,601,601,601 CDMA1xEVDO: 601,601,9970,11750,601,601,601,10570,601,601,601,601,601, 601,601,601,601,601,601,601 TD-SCDMA: 601, 5970, 19400, 20001, 601,601 OFF, FF,OFF,OFF,OFF,OFF
State Saved	Saved in instrument state.
Min	601
Max	20001
Instrument S/W Revision	Prior to A.02.00

IF Gain

Sets the IF Gain function to Auto, On (the extra 10 dB) or Off. These settings affect sensitivity and IF overloads. A switched IF amplifier with approximately 10 dB of gain is available. This amplifier takes full advantage of the RF dynamic range of the analyzer. When it can be turned on without an overload, the dynamic range is always better with the amplifier on than off.

Key Path	Meas Setup
Instrument S/W Revision	Prior to A.02.00

IF Gain Auto Activates the rules for auto IF Gain.

Mode	SA, WCDMA, C2K, WIMAX OFDMA, TD-SCDMA, 1xEV-DO, DVB-T/H
Remote Command	[:SENSe]:SPURious:IF:GAIN:AUTO[:STATe] OFF ON 0 1, OFF ON 0 1, OFF ON 0 1, OFF ON 0 1, OFF ON 0 1, OFF ON 0 1, OFF ON 0 1, OFF ON 0 1, OFF ON 0 1, OFF ON 0 1, OFF ON 0 1, OFF ON 0 1, OFF ON 0 1, OFF ON 0 1, OFF ON 0 1, OFF ON 0 1, OFF ON 0 1, OFF ON 0 1, OFF ON 0 1, OFF ON 0 1 [:SENSe]:SPURious:IF:GAIN:AUTO[:STATe]?
Example	SPUR:IF:GAIN:AUTO ON,ON SPUR:IF:GAIN:AUTO?

Dependencies/Couplings	When the sweep type is Swept, 'Auto' sets IF Gain to High Gain under any of the following conditions: the input attenuator is set to 0 dB, the preamp is turned on, or the Max Mixer Level is 20 dBm or lower. For other settings using the swept sweep type, auto sets IF Gain to Low Gain.
Preset	OFF,OFF,OFF,OFF,OFF,OFF,OFF,OFF,OFF,OFF,OFF,OFF,OFF,OFF,OFF,OFF,OFF,OFF,OFF,OFF
State Saved	Saved in instrument state.
Range	Auto Man
Instrument S/W Revision	Prior to A.02.00

IF Gain State Selects the range of IF Gain.

Remote Command: [:SENSE] :SPURious:IF:GAIN[:STATE] OFF|ON|0|1,
 OFF|ON|0|1, OFF|ON|0|1, OFF|ON|0|1, OFF|ON|0|1,
 OFF|ON|0|1, OFF|ON|0|1, OFF|ON|0|1, OFF|ON|0|1,
 OFF|ON|0|1, OFF|ON|0|1, OFF|ON|0|1, OFF|ON|0|1,
 OFF|ON|0|1, OFF|ON|0|1, OFF|ON|0|1, OFF|ON|0|1,
 OFF|ON|0|1, OFF|ON|0|1, OFF|ON|0|1
 [:SENSe] :SPURious:IF:GAIN[:STATE] ?

Example: SPUR:IF:GAIN ON,ON
 SPUR:IF:GAIN?

Preset:	OFF,OFF,OFF,OFF,OFF,OFF,OFF,OFF,OFF,OFF,OFF,OFF,OFF,OFF,OFF,OFF,OFF,OFF,OFF,OFF
State Saved:	Saved in instrument state.
Range:	Low Gain (Best for Large Signals) High Gain (Best Noise Level)
Instrument S/W Revision:	Prior to A.02.00

Meas Type

Selects either Examine or Full measurement type. This parameter is coupled to the average mode. Therefore, if the examine measurement type is selected, the measurement sets the average mode to exponential. If the full measurement type is selected, the measurement sets the average mode to repeat. The behavior of each measurement type is described in the table below. When averaging is on, trace averaging is used as each active range is measured. Averaging is not used at any other time.

Single		Continuous	
No Spurs Found	Spurs Found	No Spurs Found	Spurs Found

Spurious Emissions Measurement Meas Setup

Examine	All active ranges are measured. On completion the measurement is set to the idle state and the 'No Spurs' happening is displayed.	All active ranges are measured and the spurs found reported. On completion the measurement is set to the idle state and the trace containing the worst spur restored. The spur menu key is enabled. A marker is also added which is set to the frequency of the worst spur.	All active ranges are measured. On completion the SA remains set to last range checked with an active trace and the 'No Spurs' happening is displayed.	All active ranges are measured and the spurs found reported. On completion the SA is set to the range containing the worst spur found and continually sweeps this range. The spur menu key is enabled. A marker is also added which is set to the frequency of the worst spur.
Full	All active ranges are measured. On completion measurement is set to idle state and the 'No Spurs' happening is displayed.	All active ranges are measured and spurs found reported. On completion the measurement is set to the idle state, displaying the trace of the last active range.	Measurement continually cycles through all active ranges.	All active ranges are measured and spurs found reported. On each cycle of the active ranges the spurs found are reset. This ensures any remote queries retrieve the trace data that matches the currently displayed results.

Key Path	Meas Setup
Mode	SA, WCDMA, C2K, WIMAX OFDMA, TD-SCDMA, 1xEV-DO, DVB-T/H
Remote Command	[:SENSe]:SPURious:TYPE EXAMine FULL [:SENSe]:SPURious:TYPE?
Example	SPUR:TYPE FULL SPUR:TYPE?
Preset	EXAMine
State Saved	Saved in instrument state.
Range	Examine Full
Instrument S/W Revision	Prior to A.02.00

Spur

Displays any spurs found. It is only enabled when the measurement type is set to examine and will turn on upon completion of a measurement. Once the Spur menu key has been enabled, you can view any spur. The measurement sets the analyzer to the range in which the currently selected spur was found. The range settings only changes if the spur selected is in a range which is different from the current range

settings. A marker is used to identify the currently selected spur on the trace.

Key Path	Meas Setup
Mode	SA, WCDMA, C2K, WIMAX OFDMA, CDMA1xEVDO, TD-SCDMA, DVB-T/H
Remote Command	[:SENSe]:SPURious:SPUR <integer> [:SENSe]:SPURious:SPUR?
Example	SPUR:SPUR 55 SPUR:SPUR?
Preset	1
State Saved	No
Min	1
Max	200
Instrument S/W Revision	Prior to A.02.00

Spurious Report Mode

Sets the spurious report mode to either Limit Line Test Only or All.

Select the Limit Line Test (LIMTest) option to report only spurs above the limit line. Any spurs reported will cause the measurement to fail. See Abs Start Limit for more information.

Select All (ALL) to report all spurs detected by Peak Threshold and Peak Excursion.

Key Path	Meas Setup
Mode	SA, WCDMA, C2K, WIMAX OFDMA, TD-SCDMA, 1xEV-DO, DVB-T/H
Remote Command	[:SENSe]:SPURious:REPT:MODE ALL LIMTest [:SENSe]:SPURious:REPT:MODE?
Example	SPUR:REPT:MODE LIMT SPUR:REPT:MODE?
Preset	ALL
State Saved	Saved in instrument state.
Range	All Limit Test
Instrument S/W Revision	Prior to A.02.00

Meas Preset

Restores all measurement parameters to their default values.

Key Path	Meas Setup
Mode	SA, WCDMA, C2K, WIMAX OFDMA, TD-SCDMA, 1xEV-DO, DVB-T/H
Remote Command	:CONFigure:SPURious
Example	CONF:SPUR
Instrument S/W Revision	Prior to A.02.00

Range Preset (for TD-SCDMA only)

Sets the specific range parameters to meet the requirement of the BS mandatory limits (Category A), the BS mandatory limits (Category B) and the MS mandatory and optional limits in the TD-SCDMA mode. This key only shows up in the TD-SCDMA mode.

Key Path	Meas Setup
Instrument S/W Revision	Prior to A.02.00

Category A (for TD-SCDMA only)

Sets the range parameters to meet the requirement of the BS mandatory spurious emissions limits (Category A).

BS Mandatory spurious emissions limits, Category A

Band	Maximum level	Measurement bandwidth	Note
9 kHz – 150 kHz	-13 dBm	1 kHz	Bandwidth as in ITU-R SM.329-9, s4.1
150 kHz – 30 MHz		10 kHz	Bandwidth as in ITU-R SM.329-9, s4.1
30 MHz – 1 GHz		100 kHz	Bandwidth as in ITU-R SM.329-9, s4.1
1 GHz – 12,75 GHz		1 MHz	Upper frequency as in ITU-R SM.329-9, s2.5 table 1

(The requirement applies at frequencies within the specified frequency ranges which are more than 4 MHz under the first carrier frequency used or more than 4 MHz above the last carrier frequency used.)

Key Path	Meas Setup, Range Preset
Mode	TD-SCDMA
Remote Command	[:SENSE] :SPURious:CATegory:A
Example	SPUR:CAT:A
Dependencies/Couplings	This key is grayed out when the radio device is MS.

Instrument S/W Revision Prior to A.02.00

Category B (for TD-SCDMA only)

Sets the range parameters to meet the requirement of the BS mandatory spurious emissions limits (Category B).

BS Mandatory spurious emissions limits, Category B

Band	Maximum Level	Measurement Bandwidth	Note
9kHz – 150kHz	–36 dBm	1 kHz	Bandwidth as in ITU SM.329–9, s4.1
150kHz – 30MHz	– 36 dBm	10 kHz	Bandwidth as in ITU SM.329–9, s4.1
30MHz – 1GHz	–36 dBm	100 kHz	Bandwidth as in ITU SM.329–9, s4.1
1GHz	–30 dBm	1 MHz	Bandwidth as in ITU SM.329–9, s4.1
/			
Fc1–19,2 MHz or Fl –10 MHz whichever is the higher			
Fc1 – 19,2 MHz or Fl –10 MHz whichever is the higher	–25 dBm	1 MHz	Specification in accordance with ITU-R SM.329–9, s4.1
/			
Fc1 – 16 MHz or Fl –10 MHz whichever is the higher			
Fc1 – 16 MHz or Fl –10 MHz whichever is the higher	–15 dBm	1 MHz	Specification in accordance with ITU-R SM.329–9, s4.1
/			
Fc2 + 16 MHz or Fu +10 MHz whichever is the lower			
Fc2 + 16 MHz or Fu + 10 MHz whichever is the lower	–25 dBm	1 MHz	Specification in accordance with ITU-R SM.329–9, s4.1
/			
Fc2 +19,2 MHz or Fu + 10 MHz whichever is the lower			

Spurious Emissions Measurement Meas Setup

$F_c2 + 19,2 \text{ MHz}$ or $F_u + 10 \text{ MHz}$ whichever is the lower -30 dBm 1 MHz Bandwidth as in ITU-R SM.329–9, s4.1.
 Upper frequency as in ITU-R SM.329–9, s2.5 table 1

12,75 GHz

(The requirement applies at frequencies within the specified frequency ranges which are more than 4 MHz under the first carrier frequency used or more than 4 MHz above the last carrier frequency used.)

Key Path	Meas Setup, Range Preset
Mode	TD-SCDMA
Remote Command	[:SENSE]:SPURious:CATegory:B
Example	SPUR:CAT:B
Dependencies/Couplings	This key is grayed out when the radio device is MS.
Instrument S/W Revision	Prior to A.02.00

Mobile (for TD-SCDMA only)

Sets the range parameters to meet the requirement of both the MS general and additional spurious emissions limits.

General Spurious emissions requirements

Frequency Bandwidth	Resolution Bandwidth	Minimum requirement
$9 \text{ kHz} \leq f < 150 \text{ kHz}$	1 kHz	-36 dBm
$150 \text{ kHz} \leq f < 30 \text{ MHz}$	10 kHz	-36 dBm
$30 \text{ MHz} \leq f < 1000 \text{ MHz}$	100 kHz	-36 dBm
$1 \text{ GHz} \leq f < 12.75 \text{ GHz}$	1 MHz	-30 dBm

Additional Spurious emissions requirements

Frequency Bandwidth	Resolution Bandwidth	Minimum requirement
$925 \text{ MHz} \leq f \leq 935 \text{ MHz}$	100 KHz	-67 dBm*
$935 \text{ MHz} < f \leq 960 \text{ MHz}$	100 KHz	-79 dBm*
$1805 \text{ MHz} \leq f \leq 1880 \text{ MHz}$	100 KHz	-71 dBm*

* The measurements are made on frequencies which are integer multiples of 200 kHz.

(These requirements are only applicable for frequencies which are greater than 4 MHz away from the UE)

center carrier frequency.)

Key Path	Meas Setup, Range Preset
Mode	TD-SCDMA
Remote Command	[:SENSe] : SPURious : CATegory : MS
Example	SPUR:CAT:MS
Notes	The former command “[:SENSe]:SPURious:CATegory:MOBile” is still supported.
Dependencies/Couplings	This key is grayed out when the radio device is BTS.
Instrument S/W Revision	Prior to A.02.00

Frequency Setup (for TD-SCDMA only)

Sets the required frequency parameters for the calculation of the start/stop frequency of the spurious emissions limits in TD-SCDMA mode.

The measurement does not restart when changing the values of the setup parameters. These parameters are used for calculating the range start and stop frequency in the measurement only. If you are going to perform a measurement with the newly-input values,, one of the soft key in the “Range Preset” menu should also be pressed afterwards.

Key Path	Meas Setup
Instrument S/W Revision	Prior to A.02.00

Center Frequency of the First Carrier (Fc1) (for TD-SCDMA only) Sets the center frequency of emission of the first carrier transmitted by the base station. This parameter is used for calculating the start/stop frequency of the range for base station when the softkey “Category A” or “Category B” under the range preset menu pressed.

Key Path	Meas Setup, Freq Setup
Mode	TD-SCDMA
Remote Command	[:SENSe] : SPURious : CARRier : FREQuency : START <freq> [:SENSe] : SPURious : CARRier : FREQuency : START?
Example	SPUR:CARR:FREQ:STAR 2GHz SPUR:CARR:FREQ:STAR?
Notes	You must be in the TD-SCDMA mode. Use INSTRument:SELEct to set the mode.
Dependencies/Couplings	Coupled with Fc2 and Fl. The value of Fc1 is always not greater than the value of Fc2, and greater than the value of Fl. The following inequation for Fl, Fc1, Fc2 and Fu is satisfied: $F_l + 0.8\text{MHz} \leq F_{c1} \leq F_{c2} \leq F_u - 0.8\text{MHz}$; This key is grayed out when the radio device is MS.

Spurious Emissions Measurement Meas Setup

Preset	2.0156 GHz
State Saved	Saved in instrument state.
Min	See Coupling
Max	See Coupling
Instrument S/W Revision	Prior to A.02.00

Center Frequency of the Last Carrier (Fc2) (for TD-SCDMA only)

Sets the center frequency of emission of the last carrier transmitted by the base station. This parameter is used for calculating the start/stop frequency of the range for base station when the softkey “Category A” or “Category B” under the range preset menu pressed.

Key Path	Meas Setup, Freq Setup
Mode	TD-SCDMA
Remote Command	[:SENSE] :SPURious:CARRier:FREQuency:STOP <freq> [:SENSE] :SPURious:CARRier:FREQuency:STOP?
Example	SPUR:CARR:FREQ:STOP 10GHz SPUR:CARR:FREQ:STOP?
Notes	You must be in the TD-SCDMA mode. Use INSTRument:SElect to set the mode.
Dependencies/Couplings	This key is grayed out when the radio device is MS. Coupled with Fc1 and Fu. The value of Fc2 is always not less than the value of Fc1, and less than the value of Fu. The following inequation for Fl, Fc1, Fc2 and Fu is satisfied: $F_l + 0.8\text{MHz} \leq F_{c1} \leq F_{c2} \leq F_u - 0.8\text{MHz}$;
Preset	2.0236 GHz
State Saved	Saved in instrument state.
Min	See Coupling
Max	See Coupling
Instrument S/W Revision	Prior to A.02.00

TDD Lower Frequency (Fl) (for TD-SCDMA only)

Sets the lower frequency of the band in which TDD operates. This parameter is used for calculating the start/stop frequency of the range for base station when the softkey “Category B” under the range preset menu pressed.

Key Path	Meas Setup, Freq Setup
Mode	TD-SCDMA

Remote Command	[:SENSE] : SPURious : TDD : FREQuency : START <freq> [:SENSE] : SPURious : TDD : FREQuency : START?
Example	SPUR:TDD:FREQ:STAR 1GHz SPUR:TDD:FREQ:STAR?
Notes	You must be in the TD-SCDMA mode. Use INSTRument:SELEct to set the mode.
Dependencies/Couplings	This key is grayed out when the radio device is MS. Coupled with Fc1. The value of Fl is always less than the value of Fc1. The following inequation for Fl, Fc1, Fc2 and Fu is satisfied: $Fl + 0.8\text{MHz} \leq Fc1 \leq Fc2 \leq Fu - 0.8\text{MHz}$;
Preset	2.010 GHz
State Saved	Saved in instrument state.
Min	1.011 GHz
Max	See Coupling
Instrument S/W Revision	Prior to A.02.00

TDD Upper Frequency (Fu) (for TD-SCDMA only)

Sets the upper frequency of the band in which TDD operates. This parameter is used for calculating the start/stop frequency of the range for base station when the softkey “Category B” under the range preset menu pressed.

Key Path	Meas Setup, Freq Setup
Mode	TD-SCDMA
Remote Command	[:SENSE] : SPURious : TDD : FREQuency : STOP <freq> [:SENSE] : SPURious : TDD : FREQuency : STOP?
Example	SPUR:TDD:FREQ:STOP 1GHz SPUR:TDD:FREQ:STOP?
Notes	You must be in the TD-SCDMA mode. Use INSTRument:SELEct to set the mode.
Dependencies/Couplings	This key is grayed out when the radio device is MS. Coupled with Fc2. The value of Fu is always greater than the value of Fc2. The following inequation for Fl, Fc1, Fc2 and Fu is satisfied: $Fl + 0.8\text{MHz} \leq Fc1 \leq Fc2 \leq Fu - 0.8\text{MHz}$;
Preset	2.025 GHz
State Saved	Saved in instrument state.
Min	See Coupling

Spurious Emissions Measurement Meas Setup

Max	3.689 GHz
Instrument S/W Revision	Prior to A.02.00

Center Frequency for Mobile (for TD-SCDMA only)

Sets the center frequency of the mobile. This parameter is used for calculating the start/stop frequency of the range for mobile after the softkey “Mobile” under the range preset menu pressed.

Key Path	Meas Setup, Freq Setup
Mode	TD-SCDMA
Remote Command	[:SENSE] : SPURious : CARRier : FREQuency : MS <freq> [:SENSE] : SPURious : CARRier : FREQuency : MS?
Example	SPUR:CARR:FREQ:MS 2GHz SPUR:CARR:FREQ:MS?
Notes	You must be in the TD-SCDMA mode. Use INSTRument:SElect to set the mode. The former SCPI commands “[:SENSE]:SPURious:CARRier:FREQuency:MOBil <freq>” and “[:SENSE]:SPURious:CARRier:FREQuency:MOBil?” are still supported.
Dependencies/Couplings	This key is grayed out when the radio device is BTS.
Preset	2.0204 GHz
State Saved	Saved in instrument state.
Min	1.005 GHz
Max	3.695 GHz
Instrument S/W Revision	Prior to A.02.00

CH Mean Power (for DVB-T/H only)

Set the mean power of the signal channel. The enter value is used to calculate the limit parameter which is different according as the different mean power of the transmitter. This key only shows up in the DVB-T/H.

Category A (mean power < 25W)

Freq Range	Limit	RBW	Note
------------	-------	-----	------

9kHz~174MHz	-36dBm	100kHz	Required by EN302-296 Chapter 4.2.1 for DVB-T transmitter.
174MHz~400MHz	-82dBm	4kHz	
400MHz~790MHz	-36dBm	100kHz	
790MHz~862MHz	-76dBm	4kHz	
862MHz~1GHz	-36dBm	100kHz	
> 1GHz	-30dBm	100kHz	

Category B (25W<mean power<=1000W)

Freq Range	Limit	RBW	Note
9kHz~174MHz	-36dBm	100kHz	Required by EN302-296 Chapter 4.2.1 for DVB-T transmitter.
174MHz~400MHz	-126dBc	4kHz	
400MHz~790MHz	-36dBm	100kHz	
790MHz~862MHz	-120dBc	4kHz	
862MHz~1GHz	-36dBm	100kHz	
> 1GHz	-30dBm	100kHz	

Category C (mean power > 1000W)

Freq Range	Limit	RBW	Note
9kHz~174MHz	-36dBm	100kHz	Required by EN302-296 Chapter 4.2.1 for DVB-T transmitter.
174MHz~400MHz	-66dBm	4kHz	
400MHz~790MHz	-36dBm	100kHz	
790MHz~862MHz	-60dBm	4kHz	
862MHz~1GHz	-36dBm	100kHz	
> 1GHz	-30dBm	100kHz	

Key Path	Meas Setup
Mode	DVB-T/H
Remote Command	[:SENSe]:SPURious:CARRier:POWer <real> [:SENSe]:SPURious:CARRier:POWer?
Example	SPUR:CARR:POW -30.00 dBm SPUR:CARR:POW?

Spurious Emissions Measurement Meas Setup

Dependencies/Couplings	When the mean power of the signal channel is between 25 watt and 1000 watt, the measurement uses the current enter value as the reference to calculate the limit parameters.
Preset	-30.00 dBm
State Saved	Saved in instrument state.
Min	-250.0 dBm
Max	250.0 dBm
Instrument S/W Revision	A.02.00

Mode

See “[Mode](#)” on page [1145](#) in the section "Common Measurement Functions" for more information.

Mode Setup

See “[Mode Setup](#)” on page 1159 in the section "Common Measurement Functions" for more information.

Peak Search

Performs a peak search and opens the Peak Search menu. The Peak Search functions allow you to define specific search criteria to determine which signals can be considered peaks, excluding unwanted signals from the search.

Key Path	Front-panel key
Instrument S/W Revision	Prior to A.02.00

Peak Search

Places the selected marker on the trace point with the maximum y-axis value for that marker's trace.

Key Path	Peak Search
Mode	SA, WCDMA, C2K, WIMAX OFDMA, 1xEV-DO, DVB-T/H
Remote Command	:CALCulate:SPURious:MARKer[1] 2 3 4 5 6 7 8 9 10 11 12:MAXimum
Example	CALC:SPUR:MARK2:MAX
Instrument S/W Revision	Prior to A.02.00

Next Peak

Moves the selected marker to the peak that has the next highest amplitude less than the current marker value.

Key Path	Peak Search
Mode	SA, WCDMA, C2K, WIMAX OFDMA, TD-SCDMA, 1xEV-DO, DVB-T/H
Remote Command	:CALCulate:SPURious:MARKer[1] 2 3 4 5 6 7 8 9 10 11 12:MAXimum:NEXT
Example	CALC:SPUR:MARK2:MAX:NEXT
Instrument S/W Revision	Prior to A.02.00

Next Pk Right

Moves the selected marker to the nearest peak to the right of the current marker which meets all enabled peak criteria.

Key Path	Peak Search
Mode	SA, WCDMA, C2K, WIMAX OFDMA, TD-SCDMA, 1xEV-DO, DVB-T/H

Spurious Emissions Measurement Peak Search

Remote Command	:CALCulate:SPURious:MARKer[1] 2 3 4 5 6 7 8 9 10 11 12:MAXimum:RIGHT
Example	CALC:SPUR:MARK2:MAX:RIGH
Instrument S/W Revision	Prior to A.02.00

Next Pk Left

Moves the selected marker to the nearest peak to the left of the current marker which meets all enabled peak criteria.

Key Path	Peak Search
Mode	SA, WCDMA, C2K, WIMAX OFDMA, TD-SCDMA,1xEV-DO, DVB-T/H
Remote Command	:CALCulate:SPURious:MARKer[1] 2 3 4 5 6 7 8 9 10 11 12:MAXimum:LEFT
Example	CALC:SPUR:MARK2:MAX:LEFT
Instrument S/W Revision	Prior to A.02.00

Marker Delta

Performs the same function as the Delta 1-of-N selection key in the Marker menu. This sets the control mode for the selected marker to Delta mode. See the Marker section for the complete description of this function. The key is duplicated here in the Peak Search Menu to allow you to conveniently perform a peak search and change the control of the Marker mode to Delta without having to access two separate menus.

Key Path	Peak Search
Instrument S/W Revision	Prior to A.02.00

Pk-Pk Search

Finds and displays the amplitude and frequency (or time, if in zero span) differences between the highest and lowest y-axis value.

Key Path	Peak Search
Mode	SA, WCDMA, C2K, WIMAX OFDMA, TD-SCDMA,1xEV-DO, DVB-T/H
Remote Command	:CALCulate:SPURious:MARKer[1] 2 3 4 5 6 7 8 9 10 11 12:PTPeak
Example	CALC:SPUR:MARK:PTP
Notes	Turns on the Marker Δ
Dependencies/Couplings	This key is not available (key is grayed out) when Coupled Markers is on.

Instrument S/W Revision Prior to A.02.00

Min Search

Moves the selected marker to the minimum y-axis value on the current trace.

Key Path	Peak Search
Mode	SA, WCDMA, C2K, WIMAX OFDMA, TD-SCDMA, 1xEV-DO, DVB-T/H
Remote Command	:CALCulate:SPURious:MARKer[1 2 3 4 5 6 7 8 9 10 11 12]: MINimum
Example	CALC:SPUR:MARK:MIN
Instrument S/W Revision	Prior to A.02.00

Recall

See “[Recall](#)” on page 1179 in the section "Common Measurement Functions" for more information.

Restart

See “Restart” on page 1201 in the section "Common Measurement Functions" for more information.

Save

See “[Save](#)” on page 1203 in the section "Common Measurement Functions" for more information.

Single

See “[Single \(Single Measurement/Sweep\)](#)” on page 1229 in the section "Common Measurement Functions" for more information.

Source

See “[Source](#)” on page 1231 in the section "Common Measurement Functions" for more information.

Span X Scale

Span X Scale is unavailable in the Spurious Emissions measurement.

Key Path

Front-panel key

Instrument S/W Revision

Prior to A.02.00

Sweep/Control

Accesses the Sweep/Control menu keys used to set up and control the sweep time and source.

Key Path	Front-panel key
Instrument S/W Revision	Prior to A.02.00

Sweep Setup

Sets the sweep functions that control the sweep state and time.

Key Path	Sweep/Control
Instrument S/W Revision	Prior to A.02.00

Auto Sweep Time Rules

Switches the analyzer between normal and accuracy sweep states. Setting **Auto Sweep Time** to **Accy** will result in slower sweep times, usually about three times as long, but better amplitude accuracy for CW signals. The instrument amplitude accuracy specifications only apply when **Auto Sweep Time** is set to **Accy**.

Additional amplitude errors which occur when **Auto Sweep Time** is set to **Norm** are usually well under 0.1 dB, though this is not guaranteed. Because of the faster sweep times and still low errors, **Norm** is the preferred setting of **Auto Sweep Time**. **Auto Sweep Time** is set to **Norm** on a **Preset** or **Auto Couple**. This means that in the Preset or Auto Coupled state, instrument amplitude accuracy specifications do not apply.

Key Path	Sweep/Control, Sweep Setup
Mode	SA, WCDMA, C2K, WIMAX OFDMA, TD-SCDMA, 1xEV-DO, DVB-T/H
Remote Command	[:SENSE]:SPURious:SWEep:TIME:AUTO:RULEs NORMal ACCuracy [:SENSE]:SPURious:SWEep:TIME:AUTO:RULEs?
Example	SPUR:SWE:TIME:AUTO:RUL ACC SPUR:SWE:TIME:AUTO:RUL?
Notes	In Zero Span, this key is irrelevant and inaccessible (because the whole Sweep Setup menu is grayed out), however, Sweep Setup settings can be changed remotely with no error indication. This command is implemented as “[:SENSE]:SPURious[:RANGe][:LIST]:SWEep:TIME:AUTO:RULEs” to avoid illegal SCPI node definition. So, this command should be used as “[:SENSE]:SPURious:SWEep:TIME:AUTO:RULEs”.
Preset	NORMal
State Saved	Saved in instrument state.

Range	Norm Accey
Instrument S/W Revision	Prior to A.02.00

Pause

Pauses a measurement after the current data acquisition is complete.

When Paused, the label on the key changes to Resume. Pressing the Resume resumes the measurement at the point it was at when paused.

See [“Pause/Resume” on page 1236](#) in the "Common Measurement Functions" section for more information.

Key Path	Sweep/Control
Instrument S/W Revision	Prior to A.02.00

Trace/Detector

Trace/Detector is unavailable in the Spurious Emissions measurement.

Key Path	Front-panel key
Instrument S/W Revision	Prior to A.02.00

Trigger

Accesses the Trigger menu which contains keys to control the 1-of-N selection of the Trigger source.

The trigger functions let you select the trigger settings for a sweep or measurement.

See [“Trigger” on page 1253](#) in the "Common Measurement Functions" section for more information.

View/Display

Standard Result Screen

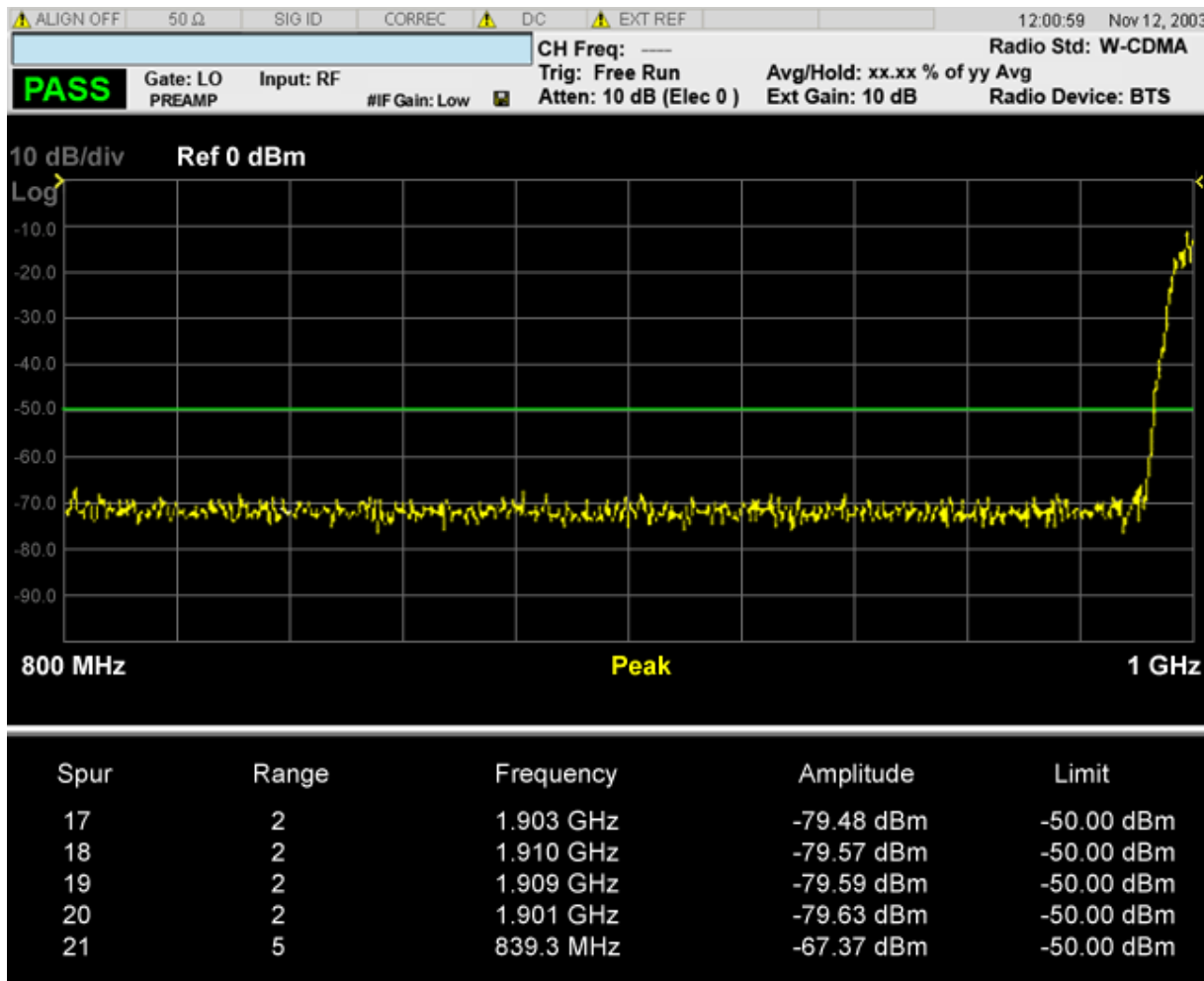

Result	Units	Min	Max
Spur	N/A	0	200
Range	N/A	1	20
Frequency	Hz	Analyzer Min	Analyzer Max
Amplitude	dBm	-150	50
Limit	dBm	-150	50
Instrument S/W Revision	Prior to A.02.00		

The spurs listed are within the current value of the Marker Peak Excursion setting of the absolute limit. All of the spurs listed passed. Any spur that has failed the absolute limit will have an 'F' beside it.

Key Path	Front-panel key
Instrument S/W Revision	Prior to A.02.00

Display

Accesses a menu of functions that enable you to set the display parameters.

See [“Display” on page 1307](#) in the "Common Measurement Functions" section for more information.

Key Path	View/Display
Instrument S/W Revision	Prior to A.02.00

The Occupied Bandwidth measurement computes and displays the bandwidth occupied by a given percentage of the total mean power of a signal.

This topic contains the following sections:

[“Remote Commands for Occupied Bandwidth ” on page 657](#)

[“Remote Command Results for Occupied Bandwidth Measurement” on page 657](#)

Remote Commands for Occupied Bandwidth

```
:CONFigure:OBWidth
:CONFigure:OBWidth:NDEFault
:INITiate:OBWidth
:FETCh:OBWidth [n]?
:MEASure:OBWidth [n]?
:READ:OBWidth [n]?
:FETCh:OBWidth:OBWidth?
:MEASure:OBWidth:OBWidth?
:READ:OBWidth:OBWidth?
:FETCh:OBWidth:FERRor?
:MEASure:OBWidth:FERRor?
:READ:OBWidth:FERRor?
:FETCh:OBWidth:XDB?
:MEASure:OBWidth:XDB?
:READ:OBWidth:XDB?
```

See also the section, [“Remote Measurement Functions” on page 1127](#).

Remote Command Results for Occupied Bandwidth Measurement

For descriptions of the results, see [“Measurement Results” on page 659](#).

n	Results Returned
---	------------------

Occupied Bandwidth Measurement

n=1 (or not specified)

Returns 6 scalar results, in the following order:

1. Occupied bandwidth – Hz
2. Total Power – dBm (Total Power will be obsolete in TD-SCDMA mode, this place will be replaced by NaN)
3. Span - Hz
4. Spectrum Trace Points - points
5. Res BW – Hz
6. Transmit Frequency Error Hz
7. x DB Bandwidth - Hz

2

Returns the frequency-domain spectrum trace (data array) for the entire frequency range being measured.

Key Path

Meas

Instrument S/W Revision

Prior to A.02.00

Measurement Results

Measurement results are described in this section. Views are described under the “View/Display” on page 703 key.

The following result descriptions are available:

“Occupied Bandwidth” on page 659

“Total Power” on page 659

“Transmit Freq Error” on page 659

“x dB Bandwidth” on page 659

Occupied Bandwidth

The occupied bandwidth result is $f_2 - f_1$, where f_1 and f_2 are calculated.

Total Power

The total power is the power integrated in the specified span setting.

Transmit Freq Error

The transmit freq error (transmit frequency error) result is calculated as the difference between $(f_2+f_1)/2$ and the tuned center frequency of the signal, where f_1 and f_2 are calculated.

x dB Bandwidth

The x dB result is a bandwidth measured between two points on the signal which are a certain number of dBs down from the highest signal point within the OBW Span. For example, If the ‘x dB’ parameter is set to -26dB, and the ‘Occupied BW Span’ is set to 10 MHz, then the maximum signal power level is first determined from the 10MHz wide trace sweep. Next, the two furthest frequencies below (xdb_f1) and above (xdb_f2) the frequency of the maximum level occurrence are found where the signal level is 26dB below the peak level. This calculation also uses linear interpolation to find the lower and upper carrier boundary point within the width of a sweep point (the span divided by the number of sweep points).

The x dB bandwidth is calculated to be $xdb_f2 - xdb_f1$.

AMPTD Y Scale (Amplitude/Y Scale)

Activates the Reference Value function and displays the Amplitude menu keys. These functions control how data on the vertical (Y) axis is displayed and control instrument settings that affect the vertical axis

See AMPTD Y Scale (Amplitude Y Scale) for more information.

Key Path	Front-panel key
Instrument S/W Revision	Prior to A.02.00

Ref Value

Sets the absolute power reference value. However, since the Auto Scaling is defaulted to On, this value is automatically determined by the measurement result. When you set a value manually, Auto Scaling automatically changes to Off.

Key Path	AMPTD Y Scale
Mode	SA, WCDMA, C2K, WIMAX OFDMA, TD-SCDMA, 1xEVDO
Remote Command	:DISPlay:OBWidth:VIEW[1]:WINDow[1]:TRACe:Y[:SCALE]:RLEV e1 <real> :DISPlay:OBWidth:VIEW[1]:WINDow[1]:TRACe:Y[:SCALE]:RLEV e1?
Example	DISP:OBW:VIEW:WIND:TRAC:Y:RLEV 125 DISP:OBW:VIEW:WIND:TRAC:Y:RLEV?
Notes	You must be in the Spectrum Analysis mode, W-CDMA mode, cdma2000 mode, TD-SCDMA mode, 1xEVDO mode or WIMAX OFDMA mode to use this command. Use:INSTrument:SELEct to set the mode.
Dependencies/Couplings	When the Auto Scaling is On, this value is automatically determined by the measurement result. When you set a value manually, Auto Scaling automatically changes to Off.
Preset	10.00 dBm
State Saved	Saved in instrument state.
Min	-250.00 dBm
Max	250.00 dBm
Instrument S/W Revision	Prior to A.02.00

Attenuation

Accesses a menu of functions that enable you to change the attenuation settings. This key has read-back text that describes the total attenuator value.

See [“Attenuation” on page 1037](#) for more information.

Key Path	AMPTD Y Scale
Instrument S/W Revision	Prior to A.02.00

Scale/Div

Sets the logarithmic units per vertical graticule division on the display. When the Auto Scaling is On, the Scale/Div is automatically determined by the measurement result. When you set a value manually, Auto Scaling is automatically toggled to Off.

Key Path	AMPTD Y Scale
Mode	SA, WCDMA, C2K, WIMAX OFDMA, TD-SCDMA, 1xEVDO
Remote Command	:DISPlay:OBWidth:VIEW[1]:WINDow[1]:TRACe:Y[:SCALe]:PDIV ision <rel_ampl> :DISPlay:OBWidth:VIEW[1]:WINDow[1]:TRACe:Y[:SCALe]:PDIV ision?
Example	DISP:OBW:VIEW:WIND:TRAC:Y:PDIV 5 DISP:OBW:VIEW:WIND:TRAC:Y:PDIV?
Notes	You must be in the Spectrum Analysis mode, W-CDMA mode, cdma2000 mode, TD-SCDMA mode, 1xEVDO mode or WIMAX OFDMA mode to use this command. Use:INSTrument:SElect to set the mode.
Dependencies/Couplings	When the Auto Scaling is On, this value is automatically determined by the measurement result. When you set a value manually, Auto Scaling automatically changes to Off.
Preset	10.00 dB
State Saved	Saved in instrument state.
Min	0.10 dB
Max	20.00 dB
Instrument S/W Revision	Prior to A.02.00

Presel Center

When this key is pressed, the centering of the preselector filter is adjusted to optimize the amplitude accuracy at the frequency of the selected marker.

See [“Presel Center” on page 1049](#) for more information.

Key Path	AMPTD/Y Scale
Instrument S/W Revision	Prior to A.02.00

Presel Adjust

Allows you to manually adjust the preselector filter frequency to optimize its response to the signal of interest. This function is only available when Presel Center is available.

See “[Preselector Adjust](#)” on page 1050 for more information.

Key Path	AMPTD/Y Scale
Instrument S/W Revision	Prior to A.02.00

Internal Preamp

Accesses a menu of functions that enable you to control the internal preamplifiers.

See “[Internal Preamp](#)” on page 1052 for more information.

Key Path	AMPTD Y Scale
Instrument S/W Revision	Prior to A.02.00

Ref Position

Positions the reference level at the top, center or bottom of the Y Scale display. Changing the reference position does not change the reference level value.

Key Path	AMPTD Y Scale
Mode	SA, WCDMA, C2K, WIMAX OFDMA, TD-SCDMA, 1xEVDO
Remote Command	:DISPlay:OBWidth:VIEW[1]:WINDow[1]:TRACe:Y[:SCALE]:RPOS ition TOP CENTer BOTTom :DISPlay:OBWidth:VIEW[1]:WINDow[1]:TRACe:Y[:SCALE]:RPOS ition?
Example	DISP:OBW:VIEW:WIND:TRAC:Y:RPOS BOTT DISP:OBW:VIEW:WIND:TRAC:Y:RPOS?
Notes	You must be in the Spectrum Analysis mode, W-CDMA mode, cdma2000 mode, TD-SCDMA mode, 1xEVDO mode or WIMAX OFDMA mode to use this command. Use:INSTrument:SELEct to set the mode.
Preset	TOP
State Saved	Saved in instrument state.
Range	Top Ctr Bot
Instrument S/W Revision	Prior to A.02.00

Auto Scaling

Allows you to toggle the Auto Scaling function between On and Off.

Key Path	AMPTD Y Scale
Mode	SA, WCDMA, C2K, WIMAX OFDMA, TD-SCDMA, 1xEVDO
Remote Command	:DISPlay:OBWidth:VIEW[1]:WINDow[1]:TRACe:Y[:SCALe]:COUPl le 0 1 OFF ON :DISPlay:OBWidth:VIEW[1]:WINDow[1]:TRACe:Y[:SCALe]:COUPl le?
Example	DISP:OBW:VIEW:WIND:TRAC:Y:COUP ON DISP:OBW:VIEW:WIND:TRAC:Y:COUP?
Dependencies/Couplings	When Auto Scaling is On, upon pressing the Restart front-panel key, this function automatically sets the scale per division to 10 dB and determines reference values based on the measurement results. When you set a value to either Scale/Div or Ref Value manually, Auto Scaling automatically changes to Off.
Preset	1
State Saved	Saved in instrument state.
Range	On Off
Instrument S/W Revision	Prior to A.02.00

Auto Couple

The Auto Couple function is not supported in this measurement.

BW

Accesses a menu of functions that enable you to specify and control the video and resolution bandwidths. You can also select the type of filter for the measurement.

Key Path	Front-panel key
Instrument S/W Revision	Prior to A.02.00

Res BW

Sets the resolution bandwidth for the current measurement. If an unavailable bandwidth is entered with the numeric keypad, the closest available bandwidth is selected.

Key Path	BW
Mode	SA, WCDMA, C2K, WIMAX OFDMA, TD-SCDMA, 1xEVDO
Remote Command	<pre>[:SENSE]:OBwidth:BANDwidth[:RESolution] <bandwidth> [:SENSE]:OBwidth:BANDwidth[:RESolution]? [:SENSE]:OBwidth:BANDwidth[:RESolution]:AUTO ON OFF 1 0 [:SENSE]:OBwidth:BANDwidth[:RESolution]:AUTO?</pre>
Example	<pre>OBW:BAND 250000 OBW:BAND? OBW:BAND:AUTO OFF OBW:BAND:AUTO?</pre>
Notes	You must be in the Spectrum Analysis mode, W-CDMA mode, cdma2000 mode, TD-SCDMA mode, 1xEVDO mode or WIMAX OFDMA mode to use this command. Use:INSTrument:SElect to set the mode.
Dependencies/Couplings	<p>Sweep time is coupled to RBW. As the RBW changes, the sweep time (if set to Auto) is changed to maintain amplitude calibration.</p> <p>Video bandwidth (VBW) is coupled to RBW. As the resolution bandwidth changes, the video bandwidth (if set to Auto) changes to maintain the ratio of VBW/RBW (10:1).</p> <p>When Res BW is set to Auto, the resolution bandwidth is auto-coupled to span. The ratio of Span/RBW is approximately 106:1 when auto coupled. When Res BW is set to Man, bandwidths are entered manually, and these bandwidths are used regardless of other analyzer settings.</p> <p>Refer to epsg1024075 for AUTO coupling rules for the resolution bandwidth.</p>

Occupied Bandwidth Measurement BW

Preset	SA: Auto WCDMA: 30 kHz CDMA2K: 12 kHz WIMAX OFDMA: 100kHz TD-SCDMA: 30kHz 1xEVDO: 30kHz SA: ON WCDMA, C2K,TD-SCDMA,WIMAX OFDMA, 1xEVDO: OFF
State Saved	Saved in instrument state.
Min	1 Hz
Max	8 MHz
Instrument S/W Revision	Prior to A.02.00

Video BW

Changes the analyzer post-detection filter.

Key Path	BW
Mode	SA, WCDMA, C2K, WIMAX OFDMA, TD-SCDMA, 1xEVDO
Remote Command	[:SENSE] :OBWidth :BANDwidth :VIDeo <bandwidth> [:SENSE] :OBWidth :BANDwidth :VIDeo? [:SENSE] :OBWidth :BANDwidth :VIDeo :AUTO ON OFF 1 0 [:SENSE] :OBWidth :BANDwidth :VIDeo :AUTO?
Example	OBW:BAND:VID 5 MHz OBW:BAND:VID? OBW:BAND:VID:AUTO ON OBW:BAND:VID:AUTO?
Notes	You must be in the Spectrum Analysis mode, W-CDMA mode, cdma2000 mode, TD-SCDMA mode, 1xEVDO mode or WIMAX OFDMA mode to use this command. Use:INSTrument:SElect to set the mode.

Dependencies/Couplings	<p>When using the average detector with either Sweep Time set to Man, or in zero span, the VBW setting has no effect and is disabled (grayed out).</p> <p>Video bandwidth (VBW) is coupled to RBW. As the resolution bandwidth changes, the video bandwidth (if set to Auto) changes to maintain the ratio set by VBW/RBW.</p> <p>Sweep Time is coupled to Video Bandwidth (VBW). As the VBW is changed, the sweep time (when set to Auto) is changed to maintain amplitude calibration. This occurs because of common hardware between the two circuits, even though the Video BW filter is not actually “in-circuit” when the detector is set to Average. Because the purpose of the average detector and the VBW filter are the same, either can be used to reduce the variance of the result.</p> <p>Although the VBW filter is not “in-circuit” when using the average detector, the Video BW key can have an effect on (Auto) sweep time, and is not disabled. In this case, reducing the VBW setting increases the sweep time, which increases the averaging time, producing a lower-variance trace.</p> <p>When the video bandwidth is AUTO coupled, the video bandwidth value is set to:</p> <p>Resolution Bandwidth * Video Bandwidth to Resolution Bandwidth Ratio</p>
Preset	<p>SA: Auto</p> <p>WCDMA: 300 kHz</p> <p>CDMA2K:120 kHz</p> <p>WIMAX OFDMA: 1MHz</p> <p>TD-SCDMA: 300kHz</p> <p>1xEVDO: 300kHz</p> <p>ON</p>
State Saved	Saved in instrument state.
Min	1 Hz
Max	50 MHz
Instrument S/W Revision	Prior to A.02.00

Filter Type

Allows you to select the type of filter to be used for the current measurement. Besides the Gaussian filter shape, there are certain special filter types, such as Flat Top, that are desirable under certain conditions.

Key Path	BW
Mode	SA, WCDMA, C2K, WIMAX OFDMA, TD-SCDMA, 1xEVDO
Remote Command	<p>[:SENSE]:OBwidth:BANDwidth:SHAPe GAUSSian FLATtop</p> <p>[:SENSe]:OBwidth:BANDwidth:SHAPe?</p>

Occupied Bandwidth Measurement BW

Example	OBW:BAND:SHAP GAUS OBW:BAND:SHAP?
Preset	GAUSSian
State Saved	Saved in instrument state.
Range	Gaussian Flattop
Instrument S/W Revision	Prior to A.02.00

Cont (Continuous)

Operation of this key is identical across several measurements. For details about this key, see “[Cont \(Continuous Measurement/Sweep\)](#)” on page 1059.

FREQ/Channel (Frequency or Channel)

Operation of this key is identical across several measurements. For details about this key, see “Frequency/Channel” on page 1061.

Input/Output

Operation of this key is identical across several measurements. For details about this key, see [“Input/Output” on page 1065](#).

Marker

Accesses a menu that enables you to select, set up and control the markers for the current measurement.

For more information, see “Marker” on page 1123.

Key Path	Front-panel key
Instrument S/W Revision	Prior to A.02.00

Select Marker

Displays the menu keys that enable you to select, set up and control the markers for the current measurement

Key Path	Marker
Instrument S/W Revision	Prior to A.02.00

Marker X Axis Value (Remote Command only)

Sets the marker X Axis value in the current marker X Axis Scale unit. It has no effect if the control mode is **Off**.

Mode	SA, WCDMA, C2K, WIMAX OFDMA, TD-SCDMA, 1xEVDO
Remote Command	:CALCulate:OBWidth:MARKer[1] 2 3 4 5 6 7 8 9 10 11 12:X <real> :CALCulate:OBWidth:MARKer[1] 2 3 4 5 6 7 8 9 10 11 12:X ?
Example	CALC:OBW:MARK3:X 0 CALC:OBW:MARK3:X?
Notes	The query returns the marker’s absolute X Axis value if the control mode is Normal , or the offset from the marker’s reference marker if the control mode is Delta . The query is returned in the fundamental units for the current marker X Axis scale: Hz for Frequency .
Preset	After a preset, all markers are turned OFF, so Marker X Axis Value query returns a not a number (NAN).
State Saved	No
Min	-9.9E+37
Max	9.9E+37
Instrument S/W Revision	Prior to A.02.00

Marker X Axis Position (Remote Command only)

Sets the marker X position in trace points. It has no effect if the control mode is **Off**.

Mode	SA, WCDMA, C2K, WIMAX OFDMA, TD-SCDMA, 1xEVDO
Remote Command	:CALCulate:OBWidth:MARKer[1] 2 3 4 5 6 7 8 9 10 11 12:X :POSition <real> :CALCulate:OBWidth:MARKer[1] 2 3 4 5 6 7 8 9 10 11 12:X :POSition?
Example	CALC:OBW:MARK10:X:POS 0 CALC:OBW:MARK10:X:POS?
Notes	The query returns the marker's absolute X Axis value in trace points if the control mode is Normal , or the offset from the marker's reference marker in trace points if the control mode is Delta .
Preset	After a preset, all markers are turned OFF, so Marker X Axis Value query returns a not a number (NAN).
State Saved	No
Min	-9.9E+37
Max	9.9E+37
Instrument S/W Revision	Prior to A.02.00

Marker Y Axis Value (Remote Command only)

Returns the marker Y Axis value in the current marker Y Axis unit.

Mode	SA, WCDMA, C2K, WIMAX OFDMA, TD-SCDMA, 1xEVDO
Remote Command	:CALCulate:OBWidth:MARKer[1] 2 3 4 5 6 7 8 9 10 11 12:Y ?
Example	CALC:OBW:MARK11:Y?
Preset	Result dependent on Markers setup and signal source.
State Saved	No
Instrument S/W Revision	Prior to A.02.00

Marker Type

Sets the marker control mode to **Normal**, **Delta** or **Off**. If the selected marker is Off, pressing Marker sets it to Normal and places a single marker at the center of the display. At the same time, **Marker X Axis Value** appears on the Active Function area.

Key Path	Marker
----------	---------------

Occupied Bandwidth Measurement Marker

Mode	SA, WCDMA, C2K, WIMAX OFDMA, TD-SCDMA, 1xEVDO
Remote Command	:CALCulate:OBWidth:MARKer[1] 2 3 4 5 6 7 8 9 10 11 12:MODE POSITION DELTA OFF :CALCulate:OBWidth:MARKer[1] 2 3 4 5 6 7 8 9 10 11 12:MODE?
Example	CALC:OBW:MARK:MODE POS CALC:OBW:MARK:MODE?
Notes	If the selected marker is Off, pressing Marker sets it to Normal and places it at the center of the screen on the trace determined by the Marker Trace rules. At the same time, Marker X Axis Value appears on the Active Function area. Default Active Function: the active function for the selected marker's current control mode. If the current control mode is Off, there is no active function and the active function is turned off. Active Function Display: the marker X axis value entered in the active function area displays the marker value to its full entered precision.
Preset	OFF
State Saved	Saved in instrument state.
Range	Normal Delta Off
Instrument S/W Revision	Prior to A.02.00

Properties

Accesses the marker properties menu.

Key Path	Marker
Instrument S/W Revision	Prior to A.02.00

Select Marker

Displays 12 markers available for selection.

Key Path	Marker, Properties
Instrument S/W Revision	Prior to A.02.00

Relative To

Selects the desired marker. The selected marker will be relative to its reference marker.

Key Path	Marker, Properties
Mode	SA, WCDMA, C2K, WIMAX OFDMA, TD-SCDMA, 1xEVDO

Remote Command	:CALCulate:OBWidth:MARKer[1] 2 3 4 5 6 7 8 9 10 11 12:R EFerence <integer> :CALCulate:OBWidth:MARKer[1] 2 3 4 5 6 7 8 9 10 11 12:R EFerence?
Example	CALC:OBW:MARK:REF 2 CALC:OBW:MARK:REF?
Notes	A marker cannot be relative to itself so that choice is grayed out, and if sent from SCPI generates error -221: "Settings conflict; marker cannot be relative to itself." When queried a single value is returned (the specified marker numbers relative marker). You must be in the Spectrum Analysis mode, WCDMA mode, TD-SCDMA mode, 1xEVDO mode or WIMAX OFDMA mode to use this command. Use:INSTrument:SElect to set the mode.
Preset	2 3 4 5 6 7 8 9 10 11 12 1
State Saved	Saved in instrument state.
Min	1
Max	12
Instrument S/W Revision	Prior to A.02.00

All Markers Off

Turns off all markers.

Key Path	Marker
Mode	SA, WCDMA, C2K, WIMAX OFDMA, TD-SCDMA, 1xEVDO
Remote Command	:CALCulate:OBWidth:MARKer:AOff
Example	CALC:OBW:MARK:AOff
Instrument S/W Revision	Prior to A.02.00

Marker Function

There are no 'Marker Functions' supported in this measurement.

Key Path	Front panel key
Instrument S/W Revision	Prior to A.02.00

Marker To

There is no 'Marker To' functionality supported in this measurement.

Key Path	Front panel key
Instrument S/W Revision	Prior to A.02.00

Meas

Operation of this key is identical across several measurements. For details about this key, see [“Meas” on page 1127](#).

Meas Setup

Displays the setup menu for the current measurement. The measurement setup parameters include the number of measurement averages used to calculate the measurement result and the averaging mode. The setup menu also includes the option to reset the measurement settings to their factory defaults.

Key Path	Front-panel key
Instrument S/W Revision	Prior to A.02.00

Avg/Hold Num

Specifies the number of measurement averages used when calculating the measurement result. The average is displayed at the end of each sweep.

Initiates an averaging routine that averages the sweep points in a number of successive sweeps, resulting in trace smoothing.

After the specified number of average counts, the average mode (termination control) setting determines the average action.

Key Path	Meas Setup
Mode	SA, WCDMA, C2K, WIMAX OFDMA, TD-SCDMA, 1xEVDO
Remote Command	[:SENSe]:OBwidth:AVERage:COUNT <integer> [:SENSe]:OBwidth:AVERage:COUNT? [:SENSe]:OBwidth:AVERage[:STATe] ON OFF 1 0 [:SENSe]:OBwidth:AVERage[:STATe]?
Example	OBW:AVER:COUN 1500 OBW:AVER:COUN? OBW:AVER ON OBW:AVER?
Notes	You must be in the Spectrum Analysis mode, W-CDMA mode, cdma2000 mode, TD-SCDMA mode, 1xEVDO mode or WIMAX OFDMA mode to use this command. Use:INSTRument:SELEct to set the mode.
Dependencies/Couplings	Averaging state is coupled to Max Hold. If Max Hold is changed from Off to On, Averaging state is automatically set to On.
Preset	10 ON
State Saved	Saved in instrument state.
Min	1

Occupied Bandwidth Measurement Meas Setup

Max	10000
Instrument S/W Revision	Prior to A.02.00

Avg Mode

Enables you to set the averaging mode.

When set to Exponential (Exp) the measurement averaging continues using the specified number of averages to compute each averaged value. The average is displayed at the end of each sweep.

When set to Repeat, the measurement resets the average counter each time the specified number of averages is reached.

Key Path	Meas Setup
Mode	SA, WCDMA, C2K, WIMAX OFDMA, TD-SCDMA, 1xEVDO
Remote Command	[:SENSE]:OBWidth:AVERage:TCONtrol EXPonential REPeat [:SENSE]:OBWidth:AVERage:TCONtrol?
Example	OBW:AVER:TCON REP OBW:AVER:TCON?
Notes	You must be in the Spectrum Analysis mode, W-CDMA mode, cdma2000 mode, TD-SCDMA mode, 1xEVDO mode or WIMAX OFDMA mode to use this command. Use:INSTrument:SELEct to set the mode.
Preset	EXP
State Saved	Saved in instrument state.
Range	Exp Repeat
Instrument S/W Revision	Prior to A.02.00

Max Hold (Remote Command Only)

When On, Max Hold displays and holds the maximum responses of the current measurement. Turn Max Hold to Off to disable the maximum hold feature.

Mode	SA, WCDMA, C2K, WIMAX OFDMA, TD-SCDMA, 1xEVDO
Remote Command	[:SENSE]:OBWidth:MAXHold ON OFF 1 0 [:SENSE]:OBWidth:MAXHold?
Example	OBW:MAXH ON OBW:MAXH?
Notes	You must be in the Spectrum Analysis mode, W-CDMA mode, cdma2000 mode, TD-SCDMA mode, 1xEVDO mode or WIMAX OFDMA mode to use this command. Use:INSTrument:SELEct to set the mode.

Dependencies/Couplings	Max Hold is coupled to Average/Hold state. The Max Hold function is activated only if Average state is On. If Max Hold is changed to On when Average state is Off, Average state is automatically set to On.
Preset	OFF
State Saved	Saved in instrument state.
Range	On Off
Instrument S/W Revision	Prior to A.02.00

Occ BW % Pwr

Assigns the percentage of the total power that is measured within the Occupied Bandwidth for the current measurement. The resulting Occupied Bandwidth limits are displayed by markers placed on the frequencies of the specified percentage.

Key Path	Meas Setup
Mode	SA, WCDMA, C2K, WIMAX OFDMA, TD-SCDMA, 1xEVDO
Remote Command	[:SENSe]:OBwidth:PERCent <real> [:SENSe]:OBwidth:PERCent?
Example	OBW:PERC 75 OBW:PERC?
Notes	You must be in the Spectrum Analysis mode, W-CDMA mode, cdma2000 mode, TD-SCDMA mode, 1xEVDO mode or WIMAX OFDMA mode to use this command. Use:INSTrument:SElect to set the mode.
Preset	99.00
State Saved	Saved in instrument state.
Min	10
Max	99.99
Instrument S/W Revision	Prior to A.02.00

x dB

Sets the x dB value used for the "x dB bandwidth" result that measures the bandwidth between two points on the signal which is x dB down from the highest signal point within the OBW Span.

Key Path	Meas Setup
Mode	SA, WCDMA, C2K, WIMAX OFDMA, TD-SCDMA, 1xEVDO
Remote Command	[:SENSe]:OBwidth:XDB <rel_ampl> [:SENSe]:OBwidth:XDB?

Occupied Bandwidth Measurement Meas Setup

Example	OBW:XDB -20 OBW:XDB?
Notes	You must be in the Spectrum Analysis mode, W-CDMA mode, cdma2000 mode, TD-SCDMA mode, 1xEVDO mode or WIMAX OFDMA mode to use this command. Use:INSTrument:SELEct to set the mode.
Preset	-26.0 dB
State Saved	Saved in instrument state.
Min	-100.0 dB
Max	-0.1 dB
Instrument S/W Revision	Prior to A.02.00

IF Gain

The **IF Gain** key can be used to set the IF Gain function to Auto, Low Gain or High Gain. These settings affect sensitivity and IF overloads.

Key Path	Meas Setup, IF Gain
Instrument S/W Revision	Prior to A.02.00

IF Gain Auto

Activates the Auto Rules for IF Gain. When Auto is active, the IF Gain is set to High Gain under and of the following conditions:

- the input attenuator is set to 0 dB
- the preamp is turned On and the frequency range is under 3.6 GHz

For other settings, Auto sets the IF Gain to Low Gain.

Key Path	Meas Setup, IF Gain
Mode	SA, WCDMA, C2K, WIMAX OFDMA, TD-SCDMA, 1xEVDO
Remote Command	[:SENSE]:OBWidth:IF:GAIN:AUTO[:STATE] ON OFF 1 0 [:SENSE]:OBWidth:IF:GAIN:AUTO[:STATE]?
Example	OBW:IF:GAIN:AUTO OFF OBW:IF:GAIN:AUTO?
Dependencies/Couplings	When the auto attenuation exists (for example, with electrical attenuator), the IF Gain setting is changed as following rule. Auto sets IF Gain to High Gain under any of the following conditions: the input attenuator is set to 0 dB, or the preamp is turned on and the frequency range is less than 3.6 GHz. For other settings, Auto sets IF Gain to Low Gain.
Preset	OFF

State Saved	Saved in instrument state.
Range	Off On
Instrument S/W Revision	Prior to A.02.00

IF Gain State

Selects the range of the IF Gain.

Key Path	Meas Setup, IF Gain
Mode	SA, WCDMA, C2K, WIMAX OFDMA, TD-SCDMA, 1xEVDO
Remote Command	[:SENSe] :OBWidth :IF :GAIN [:STATe] ON OFF 1 0 [:SENSe] :OBWidth :IF :GAIN [:STATe] ?
Example	OBW : IF : GAIN ON OBW : IF : GAIN ?
Notes	Where ON = high gain OFF = low gain
Dependencies/Couplings	When the auto attenuation exists (for example, with electrical attenuator), the IF Gain setting is changed as following rule. Auto sets IF Gain to High Gain under any of the following conditions: the input attenuator is set to 0 dB, or the preamp is turned on and the frequency range is less than 3.6 GHz. For other settings, Auto sets IF Gain to Low Gain.
Preset	OFF
State Saved	Saved in instrument state.
Range	Low Gain High Gain
Instrument S/W Revision	Prior to A.02.00

Limit

Enables you to turn on or off limit checking at the specified frequency. For results that fail the limit test, a red FAIL appears in the measure bar.

Key Path	Meas Setup
Mode	SA, WCDMA, C2K, WIMAX OFDMA, TD-SCDMA, 1xEVDO
Remote Command	:CALCulate:OBWidth:LIMit:FBLimit <freq> :CALCulate:OBWidth:LIMit:FBLimit? :CALCulate:OBWidth:LIMit[:TEST] ON OFF 1 0 :CALCulate:OBWidth:LIMit[:TEST] ?

Occupied Bandwidth Measurement Meas Setup

Example	CALC:OBW:LIM:FBL 50 kHz CALC:OBW:LIM:FBL? CALC:OBW:LIM OFF CALC:OBW:LIM?
Notes	You must be in the Spectrum Analysis mode, W-CDMA mode, cdma2000 mode, TD-SCDMA mode, 1xEVDO mode or WIMAX OFDMA mode to use this command. Use:INSTrument:SElect to set the mode.
Preset	SA, WCDMA: 5 MHz C2K: 1.48 MHz WIMAX OFDMA: 10MHz TD-SCDMA: 1.6MHz 1xEVDO: 1.48MHz SA: OFF WCDMA, WIMAX OFDMA, TD-SCDMA, 1xEVDO: ON
State Saved	Saved in instrument state.
Min	10 kHz
Max	10 MHz
Instrument S/W Revision	Prior to A.02.00

Meas Preset

Restores all measurement parameters to their default values.

Key Path	Meas Setup
Mode	SA, WCDMA, C2K, WIMAX OFDMA, TD-SCDMA, 1xEVDO
Remote Command	:CONFigure:OBWidth
Example	CONF:OBW
Instrument S/W Revision	Prior to A.02.00

Mode

Operation of this key is identical across several measurements. For details about this key, see [“Mode” on page 1145](#).

Mode Setup

Operation of this key is identical across several measurements. For details about this key, see “Frequency/Channel” on page 1061.

Peak Search

Places the selected marker on the trace point with the maximum y-axis value for that marker's trace. Pressing Peak Search with the selected marker off causes the selected marker to be set to Normal, then a peak search is immediately performed.

Key Path	Front panel key
Mode	SA, WCDMA, C2K, WIMAX OFDMA, TD-SCDMA, 1xEVDO
Remote Command	:CALCulate:OBWidth:MARKer[1] 2 3 4 5 6 7 8 9 10 11 12:MAXimum
Example	CALC:OBW:MARK2:MAX
Instrument S/W Revision	Prior to A.02.00

Recall

Operation of this key is identical across several measurements. For details about this key, see [“Recall” on page 1179](#).

Restart

Operation of this key is identical across several measurements. For details about this key, see [“Restart” on page 1201](#).

Save

Operation of this key is identical across several measurements. For details about this key, see [“Save” on page 1203](#).

Single

Operation of this key is identical across several measurements. For details about this key, see “[Single \(Single Measurement/Sweep\)](#)” on page 1229.

Source

Operation of this key is identical across several measurements. For details about this key, see [“Source” on page 1231](#).

Span X Scale

Activates the Span function and displays the menu of span functions. The parameter values are measurement independent.

Key Path	Front-panel key
Instrument S/W Revision	Prior to A.02.00

Span

Set the frequency of the occupied bandwidth span for the current measurement.

Key Path	Span X Scale
Mode	SA, WCDMA, C2K, WIMAX OFDMA, TD-SCDMA, 1xEVDO
Remote Command	[:SENSe] :OBWidth :FREQuency :SPAN <freq> [:SENSe] :OBWidth :FREQuency :SPAN?
Example	OBW:FREQ:SPAN 2.4 MHz OBW:FREQ:SPAN?
Dependencies/Couplings	When changing the Occupied Bandwidth Span, the Resolution Bandwidth and Video Bandwidth are set to AUTO to prevent the span from clipping.
Preset	SA: 3 MHz WCDMA: 10 MHz WIMAX OFDMA: 20MHz CDMA2K:2MHz TD-SCDMA: 4.8MHz 1xEVDO: 3.75MHz
State Saved	Saved in instrument state.
Min	100 Hz
Max	Hardware Dependent: Option 503 = 3.7 GHz Option 507 = 7.1 GHz Option 508 = 8.5 GHz Option 513 = 13.8 GHz Option 526 = 27.0 GHz
Instrument S/W Revision	Prior to A.02.00

Full Span

Changes the Occupied Bandwidth Span to show the full frequency range of the analyzer. When using external mixing, it changes the displayed frequency span to the frequency range specified for the selected external mixing band.

Key Path	Span X Scale
Mode	SA, WCDMA, C2K, WIMAX OFDMA
Remote Command	[:SENSE] :OBWidth:FREQuency:SPAN:FULL
Example	OBW:FREQ:SPAN:FULL
Notes	You must be in the Spectrum Analysis mode, W-CDMA mode, cdma2000 mode or WIMAX OFDMA mode to use this command. Use:INSTrument:SELEct to set the mode.
Dependencies/Couplings	Selecting full span changes the measurement span value.
Instrument S/W Revision	Prior to A.02.00

Last Span

Changes the measurement frequency span to previous measurement span setting. If there is no existing previous span value then the span remains unchanged.

Key Path	Span X Scale
Mode	SA, WCDMA, C2K, WIMAX OFDMA
Remote Command	[:SENSE] :OBWidth:FREQuency:SPAN:PREVious
Example	OBW:FREQ:SPAN:PREV
Notes	You must be in the Spectrum Analysis mode, W-CDMA mode, cdma2000 mode or WIMAX OFDMA mode to use this command. Use:INSTrument:SELEct to set the mode.
Dependencies/Couplings	Selecting last span changes the measurement span value.
Instrument S/W Revision	Prior to A.02.00

Sweep/Control

Displays a menu of functions that enable you to set up and control the sweep time and source for the current measurement.

For details about this key, see [“Sweep / Control” on page 1235](#).

Key Path	Front-panel key
Instrument S/W Revision	Prior to A.02.00

Sweep Time

Selects the length of time in which the spectrum analyzer sweeps the displayed frequency span. Additional overhead time, which impacts the sweep rate, is not calculated as part of the sweep time. In fact:

sweep rate = span/sweep time

update rate = 1/(sweep time + overhead)

sweep cycle time = sweep time + overhead

Sweep time is coupled to RBW and VBW, and is impacted by the number of sweep points, so changing those parameters may change the sweep time.

This is not available when the selected input is I/Q.

Key Path	Sweep/Control
Mode	SA, WCDMA, C2K, WIMAX OFDMA, TD-SCDMA, 1xEVDO
Remote Command	[:SENSE]:OBwidth:SWEep:TIME <time> [:SENSE]:OBwidth:SWEep:TIME? [:SENSE]:OBwidth:SWEep:TIME:AUTO OFF ON 0 1 [:SENSE]:OBwidth:SWEep:TIME:AUTO?
Example	OBW:SWE:TIME 50 ms OBW:SWE:TIME? OBW:SWE:TIME:AUTO ON OBW:SWE:TIME:AUTO?
Dependencies/Couplings	When you manually change the Sweep Time, this state automatically goes to ‘Man’.

Occupied Bandwidth Measurement Sweep/Control

Preset	SA,WIMAX OFDMA, C2K, TD-SCDMA, 1xEVDO: Automatically Calculated WCDMA: 32.6 ms SA, WIMAX OFDMA, C2K, TD-SCDMA, 1xEVDO: ON WCDMA: OFF
State Saved	Saved in instrument state.
Min	1 ms
Max	4000 s
Instrument S/W Revision	Prior to A.02.00

Sweep Setup

Accesses the sweep setup settings for the current measurement.

Key Path	Sweep/Control
Instrument S/W Revision	Prior to A.02.00

Auto Sweep Time Rules

Switches the analyzer between normal and accuracy sweep states.

Setting Auto Sweep Time to Accy results in slower sweep times, usually about three times as long, but better amplitude accuracy for CW signals. The instrument amplitude accuracy specifications only apply when Auto Sweep Time is set to Accy.

Additional amplitude errors which occur when Auto Sweep Time is set to Norm are usually well under 0.1 dB, though this is not guaranteed. Because of the faster sweep times and still low errors, Norm is the preferred setting of Auto Sweep Time. Auto Sweep Time is set to Norm on a Preset or Auto Couple. This means that in the Preset or Auto Coupled state, instrument amplitude accuracy specifications do not apply.

Key Path	Sweep/Control, Sweep Setup
Mode	SA, WCDMA, C2K, WIMAX OFDMA, TD-SCDMA, 1xEVDO
Remote Command	[:SENSe] :OBWidth :SWEep :TIME :AUTO :RULes NORMal ACCuracy [:SENSe] :OBWidth :SWEep :TIME :AUTO :RULes ?
Example	OBW:SWE:TIME:AUTO:RUL NORM OBW:SWE:TIME:AUTO:RUL?
Notes	Set to Norm when Auto Couple is pressed or sent remotely.
Preset	NORMal
State Saved	Saved in instrument state.
Range	Norm Accy

Occupied Bandwidth Measurement Sweep/Control

Notes	<p>This function is not available when signal identification is set to On (external mixing).</p> <p>Affected by:</p> <p>log sweep, segmented sweep</p> <p>Grayed out in measurements that don't support swept</p> <p>Blanked in modes that do not support swept.</p> <p>Whenever the number of sweep points change:</p> <ul style="list-style-type: none">- All trace data is erased- Any traces with Update Off also go to Display Off (like going from View to Blank in the older analyzers)- Sweep time is re-quantized- Any limit lines that are on are updated- If averaging/hold is on, averaging/hold starts over
Dependencies/Couplings	Whenever the number of sweep points change, the sweep time is re-quantized.
Preset	1001
State Saved	Saved in instrument state.
Min	101
Max	20001
Instrument S/W Revision	Prior to A.02.00

Trace/Detector

Accesses a menu of functions that enable you to control the detectors for the current measurement.

Key Path	Front-panel key
Instrument S/W Revision	Prior to A.02.00

Trace Type

Allows you to select the type of trace you want to you use for the current measurement.

The first page of this menu contains a 1-of-N selection of the trace type (Clear Write, Average, Max Hold, Min Hold) for the selected trace.

Key Path	Trace/Detector
Mode	SA, WCDMA, C2K, WIMAX OFDMA, TD-SCDMA, 1xEVDO
Remote Command	:TRACe:OBWidth:TYPE WRITe AVERAge MAXHold MINHold :TRACe:OBWidth:TYPE?
Example	TRAC:OBW:TYPE MINH TRAC:OBW:TYPE?
Notes	WRITe = Clear Write AVERAge = Average MAXHold = Maximum Hold MINHold = Minimum Hold
Dependencies/Couplings	When Detector setting is “Auto” ([:SENSe]:OBWidth:DETEctor:AUTO?), Detector ([:SENSe]:OBWidth:DETEctor[:FUNCTion]?) switches aligning with the switch of this parameter: “NORMal” with WRITe (Clear Write), “AVERAge” with AVERAge, “POSitive (peak)” with MAXHold, and “NEGative (peak)” with MINHold.
Preset	AVERAge
State Saved	Saved in instrument state.
Range	WRITe AVERAge MAXHold MINHold
Instrument S/W Revision	Prior to A.02.00

Detector

Accesses a menu of functions that enables you to control the detectors for the current measurement. The following choices are available:

— Auto- the detector selected depends on marker functions, trace functions, average type, and the trace

averaging function.

- Normal-the detector determines the peak of the CW-like signals, and it yields alternating maximums and minimums of noise-like signals. This is also referred to as Rosenfell detection.
- Average-the detector determines the average of the signal within the sweep points. The averaging method depends upon the Average Type selection (voltage, power or log scales).
- Peak (Positive)-the detector determines the maximum of the signal within the sweep points.
- Sample-the detector indicates the instantaneous level of the signal at the center of the sweep points represented by each display point.
- Negative Peak-the detector determines the minimum of the signal within the sweep points.

Key Path	Detector
Instrument S/W Revision	Prior to A.02.00

Detector Selection

Allows you to select a specific detector for the current measurement. When the detector choice is Auto, the analyzer selects the detector. The selected detector depends on marker functions, trace functions, and trace averaging functions for the current measurement.

Key Path	Trace/Detector
Mode	SA, WCDMA, C2K, WIMAX OFDMA, TD-SCDMA, 1xEVDO
Remote Command	[:SENSE]:OBWidth:DETECTOR[:FUNCTION] NORMAL AVERAGE POSITIVE SAMPLE NEGATIVE [:SENSE]:OBWidth:DETECTOR[:FUNCTION]?
Example	OBW:DET NORM OBW:DET?
Notes	When you manually select a detector (instead of selecting Auto), that detector is used regardless of other analyzer settings. The detector choices are: The Normal detector determines the peak of CW-like signals, and it yields alternating maximums and minimums of noise-like signals. This is also referred to as Rosenfell detection. The Average detector determines the average of the signal within the sweep points. The averaging method is Power Average (RMS). The Peak detector determines the maximum of the signal within the sweep points. The Sample detector indicates the instantaneous level of the signal at the center of the sweep points represented by each display point. The Negative Peak detector determines the minimum of the signal within the sweep points.

Dependencies/Couplings	When Detector setting is “Auto” ([:SENSe]:OBWidth:DETEctor:AUTO?), Detector ([:SENSe]:OBWidth:DETEctor[:FUNCTion]?) switches aligning with the switch of this parameter: “NORMal” with Clear Write, “AVERage” with AVERage, “POSitive (peak)” with MAXHold, and “NEGative (peak)” with MINHold.
Preset	AVERage
State Saved	Saved in instrument state.
Range	Normal Average Peak Sample Negative Peak
Instrument S/W Revision	Prior to A.02.00

Auto

When the detector choice is Auto, the analyzer selects the detector. The selected detector depends on marker functions, trace functions, and trace averaging functions for the current measurement.

Key Path	Trace/Detector
Mode	SA, WCDMA, C2K, WIMAX OFDMA, 1xEVDO mode
Remote Command	[:SENSe] :OBWidth :DETEctor :AUTO ON OFF 1 0 [:SENSe] :OBWidth :DETEctor :AUTO?
Example	OBW:DET:AUTO ON OBW:DET:AUTO?
Dependencies/Couplings	When Detector setting is “Auto” ([:SENSe]:OBWidth:DETEctor:AUTO?), Detector ([:SENSe]:OBWidth:DETEctor[:FUNCTion]?) switches aligning with the switch of this parameter: “NORMal” with Clear Write, “AVERage” with AVERage, “POSitive (peak)” with MAXHold, and “NEGative (peak)” with MINHold.
Preset	ON
State Saved	Saved in instrument state.
Instrument S/W Revision	Prior to A.02.00

Trigger

Operation of this key is identical across several measurements. For details about this key, see [“Trigger” on page 1253](#).

View/Display

Accesses a menu of functions that enable you to set the view and display parameters for the current measurement.

View

There is a single results view available for this measurement.

Spectrum View

NOTE An asterisk next to the x dB bandwidth value indicates the results may not have been determined with optimal analyzer settings. If this result (emission bandwidth) is your primary interest, select Meas Setup, Max Hold, On. Then change the detector mode to peak. Acquiring peak data ensures accuracy of the result.

For SA, WCDMA, C2K, 1xEVDO, WIMAX OFDMA mode:

Occupied Bandwidth Measurement
View/Display

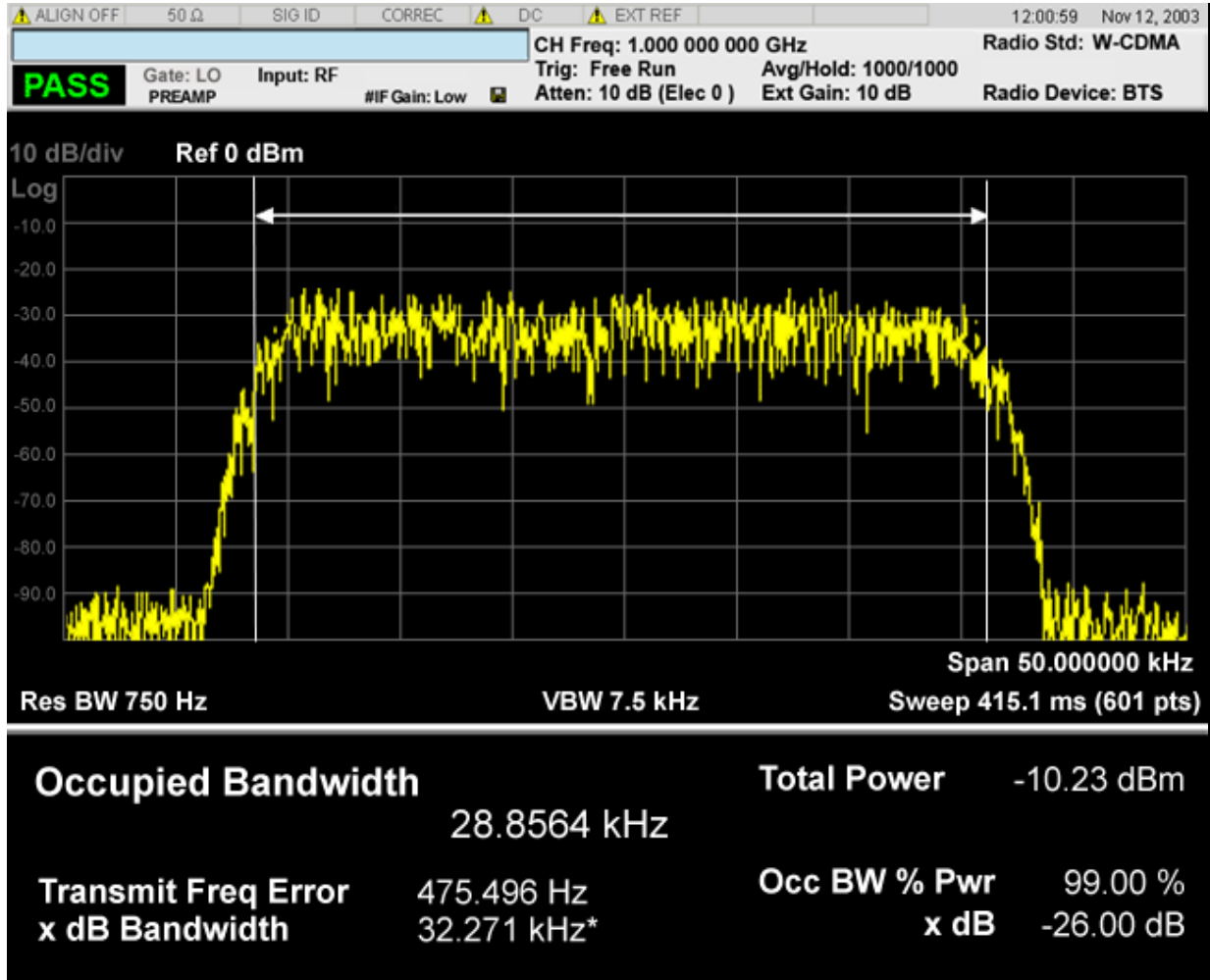

For TD-SCDMA mode only:

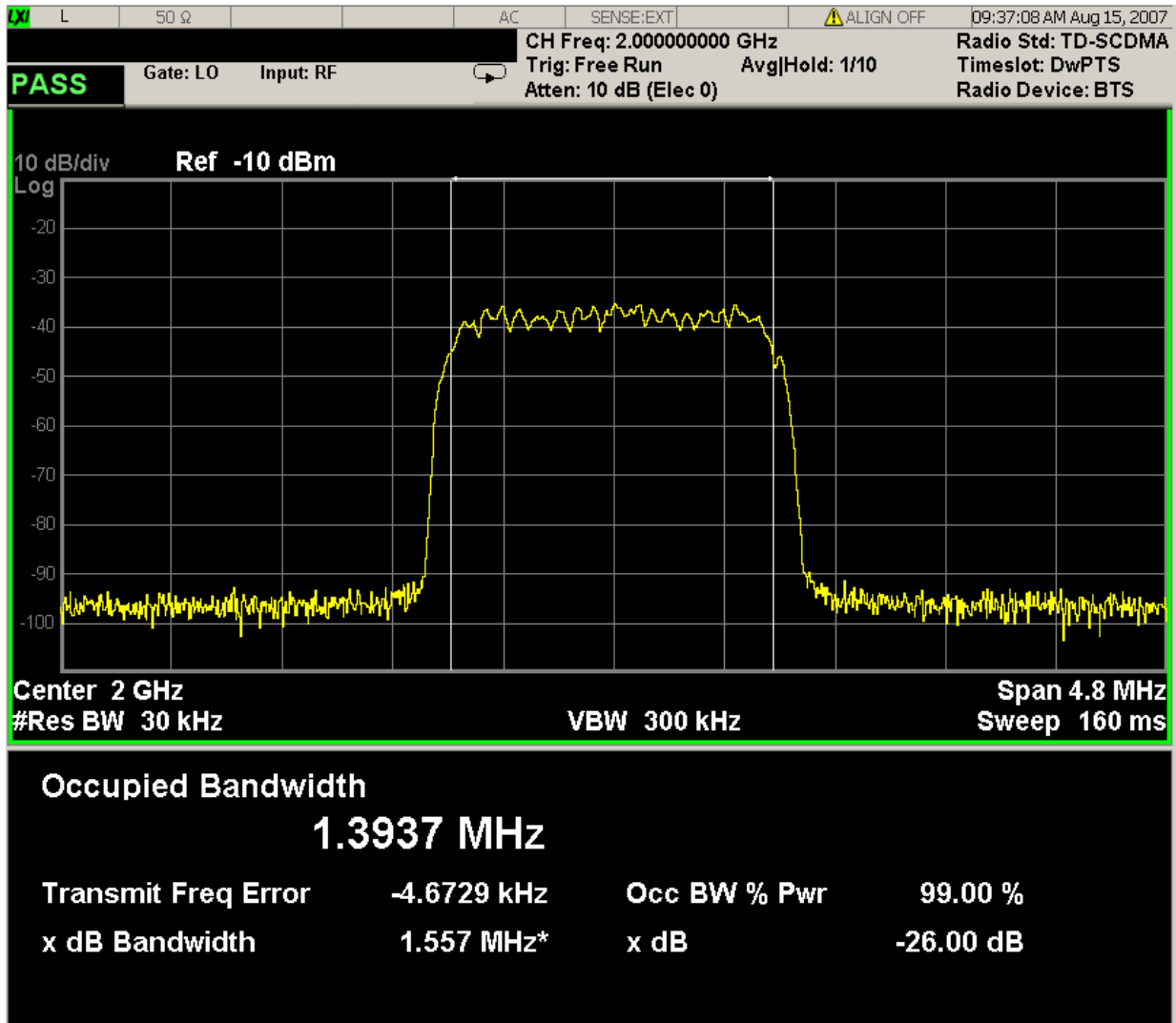

Key Path **Front-panel key**

Instrument S/W Revision Prior to A.02.00

Display

Accesses a menu of functions that enable you to set the display parameters.

Operation of this key is identical across several measurements. For details about this key, see [“Display” on page 1307](#).

Key Path **View/Display**

Instrument S/W Revision Prior to A.02.00

Many of the digitally modulated signals now look noise-like in the time and frequency domain. This means that statistical measurements of the signals can be a useful characterization. Power Complementary Cumulative Distribution Function (CCDF) curves characterize the higher level power statistics of a digitally modulated signal. The curves can be useful in determining design parameters for digital communications systems. For more information, see [“Power Stat CCDF Measurement Description” on page 709](#). For measurement results and views, see [“View/Display” on page 744](#).

This topic contains the following sections:

[“Measurement Commands for Power Stat CCDF” on page 707](#)

[“Remote Command Results for Power Stat CCDF” on page 708](#)

Measurement Commands for Power Stat CCDF

The general functionality of CONFigure, FETCh, MEASure, and READ are described at the beginning of this section. See the SENSE:PStat commands for more measurement related commands.

```
:CONFigure:PStatistic  
:CONFigure:PStatistic:NDEFault  
:INITiate:PStatistic  
:FETCh:PStatistic[n]?  
:READ:PStatistic[n]?  
:MEASure:PStatistic[n]?
```

For more measurement related commands, see the SENSE subsystem, and the section [“Remote Measurement Functions” on page 1127](#).

Remote Command Results for Power Stat CCDF

n	Results Returned
0	Returns unprocessed I/Q trace data, as a series of trace point values, in volts. The I values are listed first in each pair, using the 0 through even-indexed values. The Q values are the odd-indexed values,
not specified or 1	Returns 10 scalar results: <ol style="list-style-type: none"> 1. Average input power (in dBm) 2. Probability at the average input power level (in %) 3. Power level that has 10% of the power 4. Power level that has 1% of the power 5. Power level that has 0.1% of the power 6. Power level that has 0.01% of the power 7. Power level that has 0.001% of the power 8. Power level that has 0.0001% of the power 9. Peak power (in dB) 10.Count
2	Returns a series of 5001 floating the current measured power stat trace. This is the probability at particular power levels (average power), in the following order: <ol style="list-style-type: none"> 1. Probability at 0.0 dB power 2. Probability at 0.01 dB power 3. Probability at 0.02 dB power ... 1. Probability at 49.9 dB power 2. Probability at 50.0 dB power
3	Returns a series of 5001 floating point numbers (in percent) that represent the Gaussian trace. This is the probability at particular power levels (average power), in the following order: <ol style="list-style-type: none"> 1. Probability at 0.0 dB power 2. Probability at 0.01 dB power 3. Probability at 0.02 dB power ... 1. Probability at 49.9 dB power 2. Probability at 50.0 dB power

- 4 Returns a series of 5001 floating point numbers (in percent) that represent the user-definable reference trace. This is the probability at particular power levels (average power), in the following order:
1. Probability at 0.0 dB power
 2. Probability at 0.01 dB power
 3. Probability at 0.02 dB power
 - ...
 1. Probability at 49.9 dB power
 2. Probability at 50.0 dB power

Power Stat CCDF Measurement Description

The power statistics CCDF measurement can be affected by many factors. For example, modulation filtering, modulation format, combining the multiple signals at different frequencies, number of active codes, and correlation between symbols on different codes with spread spectrum systems will all affect measurement results. These factors are all related to modulation and signal parameters. External factors such as signal compression and expansion by nonlinear components, group delay distortion from filtering, and power control within the observation interval also affect the measurement.

The power measured in power statistics CCDF curves is actually instantaneous envelope power defined by the equation:

$$P = (I^2 + Q^2) / Z_0$$

(Where I&Q are the quadrature voltage components of the waveform and Z_0 is the characteristic impedance).

A CCDF curve is defined by how much time the waveform spends at or above a given power level. The percent of time the signal spends at or above the level defines the probability for that particular power level. For capturing a lower probability down to 0.0001%, this measurement is made in the single mode by pressing Single. To make the power statistics CCDF measurement, the instrument uses digital signal processing (DSP) to sample the input signal in the channel bandwidth. The Gaussian distribution line as the band-limited Gaussian noise CCDF reference line, the user-definable reference trace, and the currently measured trace can be displayed on a semi-log graph. If the currently measured trace is above the user reference trace, it means that the higher peak power levels against the average power are included in the input signal.

Key Path

Meas

AMPTD Y Scale

Accesses a menu of functions that enable you to set the vertical scale parameters. The parameter values are measurement independent except all Attenuation values, and the Internal Preamp selection, which are the same across all measurements.

Key Path	Front-panel key
Instrument S/W Revision	Prior to A.02.00

Attenuation

Accesses a menu of functions that enable you to change the attenuation settings. This key has read-back text that describes the total attenuator value.

See AMPTD Y Scale, “[Attenuation](#)” on page 1037 in the “Common Measurement Functions” section for more information.

This is only available when the selected input is RF.

Key Path	AMPTD Y Scale
Instrument S/W Revision	Prior to A.02.00

Range

Accesses the Range menu to change baseband I/Q gain settings. This key has a readback text that describes gain range value. Refer to “[Range](#)” on page 1043 in the “Common Measurement Functions” for more information.

Key Path	AMPTD/Y Scale
Instrument S/W Revision	Prior to A.02.00

Presel Center

When this key is pressed, the centering of the preselector filter is adjusted to optimize the amplitude accuracy at the frequency of the selected marker.

See AMPTD Y Scale, “[Presel Center](#)” on page 1049 in the “Common Measurement Functions” section for more information.

This is only available when the selected input is RF.

Key Path	AMPTD/Y Scale
Instrument S/W Revision	Prior to A.02.00

Presel Adjust

Allows you to manually adjust the preselector filter frequency to optimize its response to the signal of interest. This function is only available when Presel Center is available.

See AMPTD Y Scale, [“Preselector Adjust” on page 1050](#) in the “Common Measurement Functions” section for more information.

This is only available when the selected input is RF.

Key Path	AMPTD/Y Scale
Instrument S/W Revision	Prior to A.02.00

Internal Preamp

Accesses a menu of functions that enable you to control the internal preamplifiers.

See AMPTD Y Scale, [“Internal Preamp” on page 1052](#) in the “Common Measurement Functions” section for more information.

This is only available when the selected input is RF.

Key Path	AMPTD Y Scale
Instrument S/W Revision	Prior to A.02.00

Auto Couple

See “[AUTO COUPLE](#)” on page 1055 in the section “Common Measurement Functions” for more information.

BW

Opens the BW menu, which contains keys to control the information bandwidth functions of the instrument.

Key Path	Front-panel key
Instrument S/W Revision	Prior to A.02.00

Info BW

Allows you to enter a frequency value to set the channel bandwidth that will be used for data acquisition.

Key Path	BW
Mode	SA, WCDMA, C2K, WIMAXOFDMA, TD-SCDMA, 1xEV-DO, DVB-T/H, DTMB
Remote Command	[:SENSE]:PStatistic:BANDwidth <freq> [:SENSE]:PStatistic:BANDwidth?
Example	PST:BAND 8 MHz PST:BAND?
Dependencies/Couplings	WiMAX OFDMA: The default value depends on the Radio Standard selection..
Preset	SA, WCDM: 5 MHz C2K:1.5 MHz 1xEV-DO:1.3 MHz WiMAX OFDMA: 25 MHz TD-SCDMA: 1.3 MHz DVB-T/H, DTMB: 8 MHz
State Saved	Saved in instrument state.
Min	10.0 kHz
Max	Hardware Dependent: No Option = 10 MHz Option B25 = 25 MHz
Instrument S/W Revision	Prior to A.02.00

Cont

See “[Cont \(Continuous Measurement/Sweep\)](#)” on page 1059 in the section "Common Measurement Functions" for more information.

FREQ Channel

See “[Frequency/Channel](#)” on page 1061 in the section "Common Measurement Functions" for more information.

Input/Output

See “[Input/Output](#)” on page 1065 in the section "Common Measurement Functions" for more information.

Marker

Accesses a menu that enables you to select, set up and control the markers for the current measurement.

See the "Marker Functions" section for more information

Key Path	Front-panel key
Instrument S/W Revision	Prior to A.02.00

Select Marker

Accesses a menu that allows you to select one of 12 markers for control and function

Key Path	Marker
Instrument S/W Revision	Prior to A.02.00

Marker Type

Sets the marker control mode to **Normal**, **Delta**, **Fixed** or **Off**.

If the selected marker is Off, pressing Marker sets it to Normal and places it at the center of the screen on the trace determined by the **Marker Trace** rules. At the same time, **Marker X Axis Value** appears on the Active Function area.

The Active function for the selected marker's current control mode is the default active function. If the current control mode is Off, there is no active function and the active function is turned off. The active function display is the marker X axis value entered in the active function area will display the marker value to its full entered precision.

All interactions and dependencies detailed under the key description are enforced when the remote command is sent.

Key Path	Marker
Mode	SA, WCDMA, C2K, WiMAX OFDMA, TD-SCDMA, 1xEV-DO, DVB-T/H, DTMB
Remote Command	:CALCulate:PStatistic:MARKer[1] 2 3 4 5 6 7 8 9 10 11 12:MODE POSITION DELTA OFF :CALCulate:PStatistic:MARKer[1] 2 3 4 5 6 7 8 9 10 11 12:MODE?
Example	CALC:PST:MARK:MODE POS CALC:PST:MARK:MODE?

Power Stat CCDF Measurement Marker

Notes	<p>If the selected marker is Off, pressing Marker sets it to Normal and places it at the center of the screen on the trace determined by the Marker Trace rules. At the same time, Marker X Axis Value appears on the Active Function area.</p> <p>Default Active Function: the active function for the selected marker's current control mode. If the current control mode is Off, there is no active function and the active function is turned off.</p> <p>Active Function Display: the marker X axis value entered in the active function area will display the marker value to its full entered precision.</p>
Preset	OFF
State Saved	Saved in instrument state.
Range	Normal Delta Off
Instrument S/W Revision	Prior to A.02.00

Marker X Axis Value

Sets the marker X Axis value in the current marker X Axis Scale unit. This function has no effect if the control mode is **Off**, but is the remote command equivalent of entering an X value if the control mode is **Normal** or **Delta**.

Mode	SA, WCDMA, C2K, WIMAXOFDMA, TD-SCDMA, 1xEV-DO, DVB-T/H, DTMB
Remote Command	<pre>:CALCulate:PSTatic:MARKer[1] 2 3 4 5 6 7 8 9 10 11 12:X <rel_amp1></pre> <pre>:CALCulate:PSTatic:MARKer[1] 2 3 4 5 6 7 8 9 10 11 12:X?</pre>
Example	<pre>CALC:PST:MARK3:X 0</pre> <pre>CALC:PST:MARK3:X?</pre>
Notes	<p>If no suffix is sent, it will use the fundamental units for the current marker X Axis Scale. If a suffix is sent that does not match the current marker X Axis Scale unit, an error "Invalid suffix" will be generated. If the specified marker is Fixed and a Marker Function is on, error -221 "Settings conflict; cannot adjust Fixed marker while Marker Function is on" is generated.</p> <p>The query returns the marker's absolute X Axis value if the control mode is Normal, or the offset from the marker's reference marker if the control mode is Delta. The query is returned in the fundamental units for the current marker X Axis scale: Hz for Frequency and Inverse Time, seconds for Period and Time. If the marker is Off the response is not a number.</p>
Preset	After a preset, all Markers are turned OFF, so Marker X Axis Value query will return a not a number (NAN).
State Saved	No
Min	-9.9E+37

Max 9.9E+37
 Instrument S/W Revision Prior to A.02.00

Marker Y Axis Value

Queries the marker Y Axis value in the current marker Y Axis unit.

Mode SA, WCDMA, C2K, WIMAXOFDMA, TD-SCDMA, 1xEV-DO, DVB-T/H, DTMB

Remote Command :CALCulate:PStatistic:MARKer[1]|2|3|4|5|6|7|8|9|10|11|12:Y?

Example CALC:PST:MARK11:Y?

Notes The query returns the marker Y-axis result, if the control mode is **Normal**, or **Delta**. If the marker is **Off** the response is not a number.

Preset 0

State Saved No

Instrument S/W Revision Prior to A.02.00

Properties

Accesses the marker properties menu.

Key Path **Marker**
 Instrument S/W Revision Prior to A.02.00

Select Marker

Accesses a menu that allows you to select one of 12 markers for control and function

Key Path **Marker, Properties**
 Instrument S/W Revision Prior to A.02.00

Relative To

Sets the reference marker that the selected marker will be relative to.

Key Path **Marker, Properties**
 Mode SA, WCDMA, C2K, WIMAXOFDMA, TD-SCDMA, 1xEV-DO, DVB-T/H, DTMB

Power Stat CCDF Measurement Marker

Remote Command	:CALCulate:PStatistic:MARKer[1] 2 3 4 5 6 7 8 9 10 11 12:REFerence <integer> :CALCulate:PStatistic:MARKer[1] 2 3 4 5 6 7 8 9 10 11 12:REFerence?
Example	CALC:PST:MARK:REF 3 CALC:PST:MARK:REF?
Notes	A marker cannot be relative to itself so that choice is grayed out, and if sent from SCPI generates error -221: "Settings conflict; marker cannot be relative to itself." When queried a single value will be returned (the specified marker numbers relative marker).
Preset	2 3 4 5 6 7 8 9 10 11 12 1
State Saved	Saved in instrument state.
Min	1
Max	12
Instrument S/W Revision	Prior to A.02.00

Marker Trace

Assigns the specified marker to the designated trace. The trace choices are: Measured, Gaussian, or Reference.

Key Path	Marker
Mode	SA, WCDMA, C2K, WIMAXOFDMA, TD-SCDMA, 1xEV-DO, DVB-T/H, DTMB
Remote Command	:CALCulate:PStatistic:MARKer[1] 2 3 4 5 6 7 8 9 10 11 12:TRACe MEASured GAUSSian REFerence :CALCulate:PStatistic:MARKer[1] 2 3 4 5 6 7 8 9 10 11 12:TRACe?
Example	CALC:PST:MARK3:TRAC MEAS CALC:PST:MARK:TRACE?
Preset	MEASured
State Saved	Saved in instrument state.
Range	Measured Gaussian Reference
Instrument S/W Revision	Prior to A.02.00

Couple Markers

When this function is true, moving any marker causes an equal X axis movement of every other marker which is not **Off**. By "equal X axis movement" we mean that we preserve the difference between each

marker's X axis value (in the fundamental x-axis units of the trace that marker is on) and the X axis value of the marker being moved (in the same fundamental x-axis units).

Key Path	Marker
Instrument S/W Revision	Prior to A.02.00

All Markers Off

Turns off all markers.

Key Path	Marker, More
Mode	SA, WCDMA, C2K, WIMAXOFDMA, TD-SCDMA, 1xEV-DO, DVB-T/H, DTMB
Remote Command	:CALCulate:PStatistic:MARKer:AOFF
Example	CALC:PST:MARK:AOFF
Instrument S/W Revision	Prior to A.02.00

Marker To

There is no 'Marker To' functionality supported in Power Stat CCDF. The front-panel key will display a blank menu when pressed.

Key Path	Front-panel key
Instrument S/W Revision	Prior to A.02.00

Marker Function

There are no 'Marker Function' supported in Power Stat CCDF. The front-panel key will display a blank menu when pressed.

Key Path	Front-panel key
Instrument S/W Revision	Prior to A.02.00

Meas

See “[Meas](#)” on page 1127 in the section "Common Measurement Functions" for more information.

Meas Setup

Accesses the functions that allow you to change the settings for your measurement requirements.

Key Path	Front-panel key
Instrument S/W Revision	Prior to A.02.00

Counts

Sets the accumulated number of sampling points for data acquisition. The range is 1.000 kpt (k point) to 2.00000 Gpt (G point) with 1 kpt resolution. Counts couples to Meas Cycles. When the value for counts is changed, the Meas Cycles value will be $(\text{Counts} / \text{SamplingFrequency} * \text{MeasInterval})$.

Key Path	Meas Setup
Mode	SA, WCDMA, C2K, WIMAXOFDMA, TD-SCDMA, 1xEV-DO, DVB-T/H, DTMB
Remote Command	<code>[:SENSE]:PStatistic:COUNTs <integer></code> <code>[:SENSE]:PStatistic:COUNTs?</code>
Example	PST:COUN 5001 PST:COUN?
Dependencies/Couplings	This value is coupled to Meas Cycles. When Counts is changed, the MeasCycles value will be $(\text{Counts} / \text{SamplingFrequency} * \text{MeasInterval})$. TD-SCDMA: When Counts is changed, the MeasCycles value will be $(\text{Counts} / (\text{Sampling Frequency} * \text{Time duration of measured time slots} / 5 \text{ msec}))$, Time duration of measured time slots is determined by Analysis Time Slot and Measure Interval.
Preset	10000000
State Saved	Saved in instrument state.
Min	1000
Max	2000000000
Default Unit	Kpt
Instrument S/W Revision	Prior to A.02.00

Meas Cycles

Set the number of measurement cycles to calculate power statistic data. This number couples to Counts. The Counts value is $(\text{MeasCycles} * \text{Sampling Frequency} * \text{MeasInterval})$.

When the counts value cannot be divided by $(\text{Sampling Frequency} * \text{MeasInterval})$, this value is

Power Stat CCDF Measurement
Meas Setup

displayed as a decimal fraction.

Key Path	Meas Setup
Mode	SA, WCDMA, C2K, WiMAX OFDMA, TD-SCDMA, 1xEV-DO, DVB-T/H, DTMB
Remote Command	[:SENSE]:PStatistic:SWEep:CYCLes <integer> [:SENSE]:PStatistic:SWEep:CYCLes?
Example	PST:SWE:CYCL 1001 PST:SWE:CYCL?
Notes	.
Dependencies/Couplings	The Counts value will be (MeasCycles * Sampling Frequency * MeasInterval). TD-SCDMA: The Counts value will be (MeasCycles * Sampling Frequency * Time duration of measured time slots / 5 msec), Time duration of measured time slots is determined by Analysis Time Slot and Measure Interval.
Preset	Depends on the sampling frequency.
Min	1
Max	Depends on the sampling frequency.
Instrument S/W Revision	Prior to A.02.00

Meas Interval (When the application is NOT CDMA1xEVDO)

Sets the number of data points to be used as the measurement interval. This value couples to Counts. The Counts value is (MeasCycles * Sampling Frequency * MeasInterval).

Key Path	Meas Setup
Mode	SA, WCDMA, C2K, WiMAX OFDMA, TD-SCDMA, 1xEV-DO, DVB-T/H, DTMB
Remote Command	[:SENSE]:PStatistic:SWEep:TIME <time> [:SENSE]:PStatistic:SWEep:TIME?
Example	PST:SWE:TIME 2 ms PST:SWE:TIME?
Dependencies/Couplings	The Counts value will be (MeasCycles * Sampling Frequency * MeasInterval). WiMAX OFDMA: The default value depends on Radio Device status. TD-SCDMA: The Counts value will be (MeasCycles * Sampling Frequency * Time duration of measured time slots / 5 msec), Time duration of measured time slots is determined by Analysis Time Slot and Measure Interval. When TriggerSource is RFBurst, this button is grayed.

Preset	Others: 1.0 ms TD-SCDMA: 1 slot
Min	Others: 50.0 us TD-SCDMA: 1 slot
Max	Others: 10.0 ms TD-SCDMA: 9 slot
Instrument S/W Revision	Prior to A.02.00

Meas Interval (CDMA1xEVDO Only)

Sets the value of time to be used as the measurement interval. This value couples to Counts. The Counts value is (MeasCycles * Sampling Frequency * MeasInterval).

Key Path	Meas Setup
Mode	1xEV-DO
Remote Command	[:SENSe]:PStatistic:SWEep:TIME <time> [:SENSe]:PStatistic:SWEep:TIME?
Example	PST:SWE:TIME 2 ms PST:SWE:TIME?
Dependencies/Couplings	The Counts value will be (MeasCycles * Sampling Frequency * MeasInterval).
Preset	182.29 us
State Saved	true
Min	1.0 us
Max	10.0 ms
Instrument S/W Revision	Prior to A.02.00

Meas Offset (CDMA1xEVDO Only)

Sets the value of time to be used as the measurement interval start.

Key Path	Meas Setup
Mode	CDMA1xEVDO
Remote Command	[:SENSe]:PStatistic:SWEep:OFFSet <time> [:SENSe]:PStatistic:SWEep:OFFSet?
Example	PST:SWE:OFFS 2 ms PST:SWE:OFFS?

Power Stat CCDF Measurement Meas Setup

Preset	325.52 us
State Saved	true
Min	1.0 us
Max	10.0 ms
Instrument S/W Revision	Prior to A.02.00

IF Gain

Sets the IF Gain function to Auto, Low Gain or High Gain. These settings affect sensitivity and IF overloads.

This only applies to the RF input. It does not apply to baseband I/Q input.

Key Path	Meas Setup
Instrument S/W Revision	Prior to A.02.00

IF Gain Auto

Activates the Auto Rules for IF Gain When Auto is active, the IF Gain is set to High Gain under any of the following conditions:

- the input attenuator is set to 0 dB
- the preamp is turned On
- the Max Mixer Level is –20 dBm or lower

For other settings, Auto sets IF Gain to Off.

Key Path	Meas Setup,More,IF Gain
Mode	SA, WCDMA, C2K, WiMAX OFDMA, TD-SCDMA, 1xEV-DO, DVB-T/H, DTMB
Remote Command	[:SENSe]:PStatistic:IF:GAIN:AUTO[:STATe] ON OFF 1 0 [:SENSe]:PStatistic:IF:GAIN:AUTO[:STATe]?
Example	PST:IF:GAIN:AUTO ON PST:IF:GAIN:AUTO?
Notes	IF Gain only applies to the RF input. It does not apply to baseband I/Q input.

Dependencies/Couplings	<p>When either the auto attenuation is active (for example, with electrical attenuator), or the optimize mechanical attenuator range is requested, the IF Gain setting is changed using the following rule.</p> <p>The Auto selection sets IF Gain On under any of the following conditions:</p> <ul style="list-style-type: none"> • the input attenuator is set to 0 dB • the preamp is turned on, • the Max Mixer Level is –20 dBm or lower. <p>For other settings, Auto sets IF Gain to Off.</p>
Preset	OFF
State Saved	Saved in instrument state.
Range	Auto Man
Instrument S/W Revision	Prior to A.02.00

IF Gain State

Selects the range of IF gain. On sets the high gain option, which allows for better noise level measurements and Off sets low gain when measuring large signals.

Key Path	Meas Setup, More, IF Gain
Mode	SA, WCDMA, C2K, WIMAXOFDMA, TD-SCDMA, 1xEV-DO, DVB-T/H, DTMB
Remote Command	[:SENSE]:PStatistic:IF:GAIN[:STATE] ON OFF 1 0 [:SENSE]:PStatistic:IF:GAIN[:STATE]?
Example	PST:IF:GAIN ON PST:IF:GAIN?
Notes	IF Gain only applies to the RF input. It does not apply to baseband I/Q input. where ON = high gain OFF = low gain
Preset	OFF
State Saved	Saved in instrument state.
Range	Low Gain (Best for Large Signals) High Gain (Best Noise Level)
Instrument S/W Revision	Prior to A.02.00

Meas Preset

Restores all measurement settings to their default values.

Key Path	Meas Setup, More
----------	-------------------------

Power Stat CCDF Measurement Meas Setup

Mode	SA, WCDMA, C2K, WIMAXOFDMA, TD-SCDMA, 1xEV-DO, DVB-T/H, DTMB
Remote Command	:CONFigure:PStatistic
Example	CONF:PST
Notes	You must be in the Spectrum Analysis mode, W-CDMA mode, cdma2000 mode, TD-SCDMA mode, DVB-T/H mode, DTMB mode or WIMAXOFDMA mode to use this command. Use :INSTrument:SElect to set the mode.
Dependencies/Couplings	Selecting Meas Preset will restore all measurement parameters to their default values.
Instrument S/W Revision	Prior to A.02.00

Mode

See “[Mode](#)” on page [1145](#) in the section "Common Measurement Functions" for more information.

Mode Setup

See “[Mode Setup](#)” on page 1159 in the section "Common Measurement Functions" for more information.

Peak Search

There is no 'Peak Search' functionality supported in Power Stat CCDF. The front-panel key will display a blank menu when pressed.

Key Path	Front-panel key
Instrument S/W Revision	Prior to A.02.00

Recall

See “[Recall](#)” on page 1179 in the section "Common Measurement Functions" for more information.

Restart

See “Restart” on page 1201 in the section "Common Measurement Functions" for more information.

Save

See “[Save](#)” on page 1203 in the section "Common Measurement Functions" for more information.

Single

See “[Single \(Single Measurement/Sweep\)](#)” on page 1229 in the section "Common Measurement Functions" for more information.

Source

See “[Source](#)” on page 1231 in the section "Common Measurement Functions" for more information.

Span X Scale

The SPAN X Scale key accesses the menu to set the desired horizontal scale.

Key Path	Front-panel key
Instrument S/W Revision	Prior to A.02.00

Scale/Div

Enables you to enter a time value to change the horizontal scale.

Key Path	Power Statistic CCDF - Span X Scale
Key Path	Span X Scale
Mode	SA, WCDMA, C2K, WIMAXOFDMA, TD-SCDMA, 1xEV-DO, DVB-T/H, DTMB
Remote Command	:DISPlay:PStatistic:VIEW[1]:WINDow2:TRACe:X[:SCALE]:PDI Vision <rel_ampl> :DISPlay:PStatistic:VIEW[1]:WINDow2:TRACe:X[:SCALE]:PDI Vision?
Example	DISP:PST:VIEW:WIND2:TRAC:X:PDIV 10 DISP:PST:VIEW:WIND2:TRAC:X:PDIV?
Notes	CCDF measurement has the trace display only at Window 2.
Dependencies/Couplings	See Notes
Preset	2.00
State Saved	Saved in instrument state.
Min	0.1
Max	20
Instrument S/W Revision	Prior to A.02.00

Sweep/Control

Enables you to pause the power statistics CCDF measurement after the current data acquisition is complete. When Paused, the label on the menu key changes to Resume. Press the Resume key to resume the measurement where it was when it was paused.

Key Path	Front-panel key
Instrument S/W Revision	Prior to A.02.00

Pause/Resume

Pauses a measurement after the current data acquisition is complete. When Paused, the label on the key changes to Resume. Press the Resume key to resume the measurement where it was when it was paused. See [“Pause/Resume” on page 1236](#) in the “Common Measurement Functions” section for details.

Key Path	Sweep/Control
Instrument S/W Revision	Prior to A.02.00

Trace/Detector

Accesses a menu of functions that enable you to control the storage and manipulation of the reference trace, as well as controls the display of the trace data.

Key Path	Front-panel key
Instrument S/W Revision	Prior to A.02.00

Store Ref Trace

Copies the currently measured curve as the user-definable reference trace. The captured data remains until the other mode is chosen. Pressing this key also refreshes the reference trace.

No query command is available.

Key Path	Trace/Detector
Mode	SA, WCDMA, C2K, WIMAXOFDMA, TD-SCDMA, 1xEV-DO, DVB-T/H, DTMB
Remote Command	:CALCulate:PStatistic:StORe:REFeRence
Example	CALC:PST:STOR:REF
Instrument S/W Revision	Prior to A.02.00

Ref Trace

Toggles the reference trace display between On and Off.

Key Path	Trace/Detector
Mode	SA, WCDMA, C2K, WIMAXOFDMA, TD-SCDMA, 1xEV-DO, DVB-T/H, DTMB
Remote Command	[:SENSe]:PStatistic:RTRace[:StAtE] OFF ON 0 1 [:SENSe]:PStatistic:RTRace[:StAtE]?
Example	PST:RTR OFF PST:RTR?
Preset	OFF
State Saved	Saved in instrument state.
Range	On Off
Instrument S/W Revision	Prior to A.02.00

Gaussian Line

Toggles the Gaussian trace display between On and Off.

Key Path	Trace/Detector
Mode	SA, WCDMA, C2K, WIMAXOFDMA, TD-SCDMA, 1xEV-DO, DVB-T/H, DTMB
Remote Command	[:SENSe]:PStatistic:GAUSSian[:STATe] OFF ON 0 1 [:SENSe]:PStatistic:GAUSSian[:STATe]?
Example	PST:GAUS OFF PST:GAUS?
Preset	ON
State Saved	Saved in instrument state.
Range	On Off
Instrument S/W Revision	Prior to A.02.00

Trigger

Accesses a menu of functions that enable you to select and control the trigger source for the current measurement. See [“Trigger” on page 1253](#) in the "Common Measurement Functions" section for more information.

View/Display

Accesses a menu of functions that enable you to control the instrument display as well as turn the bar graph On and Off.

The Power Stat CCDF measurement consists of single view. This is common for both Uplink (MS) and Downlink (BTS). The view consists of the following windows: Metrics (left) and graph display (right).

“Metrics window” on page 746

“Graph window” on page 746

“Wave window (TD-SCDMA only)” on page 746

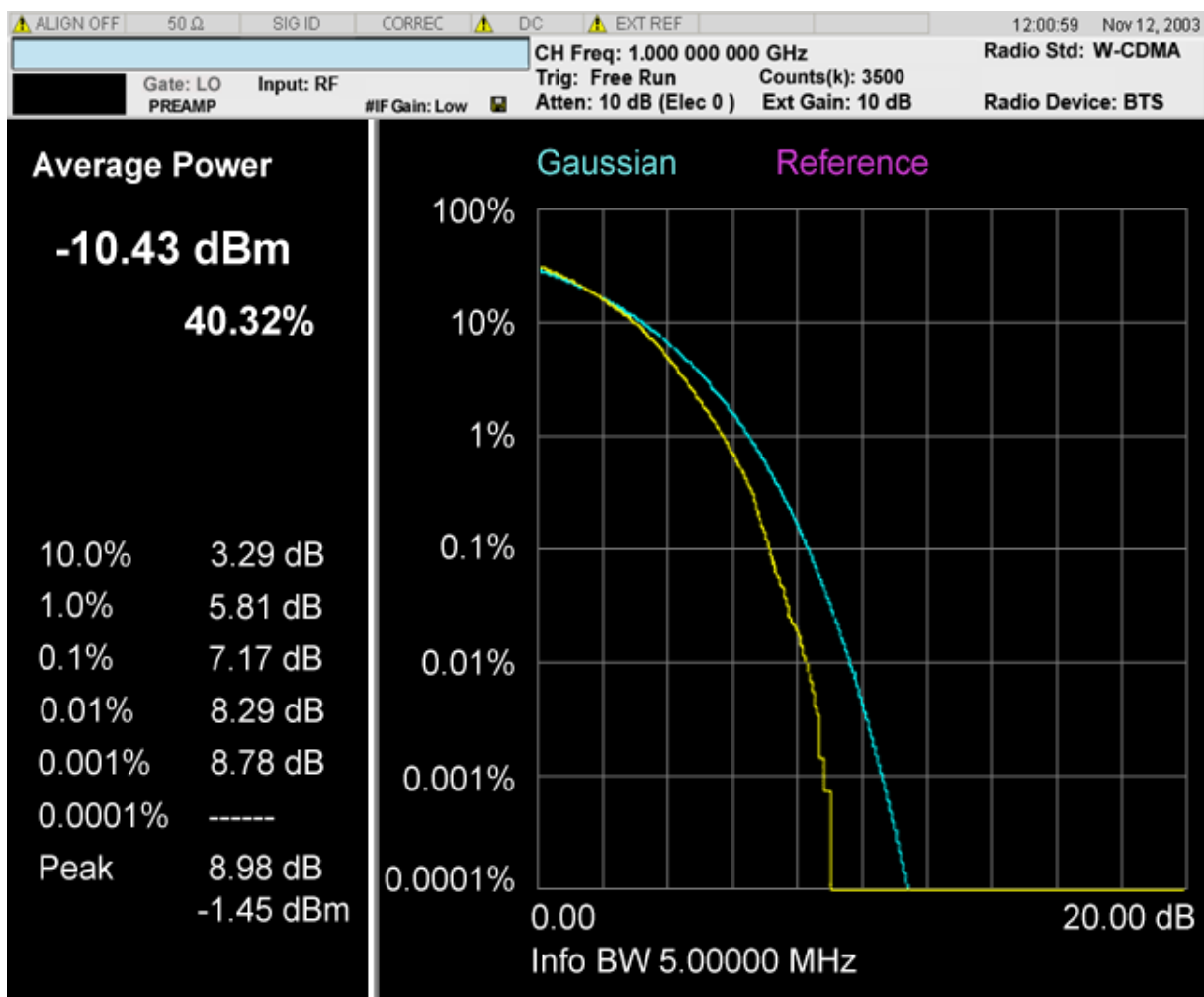

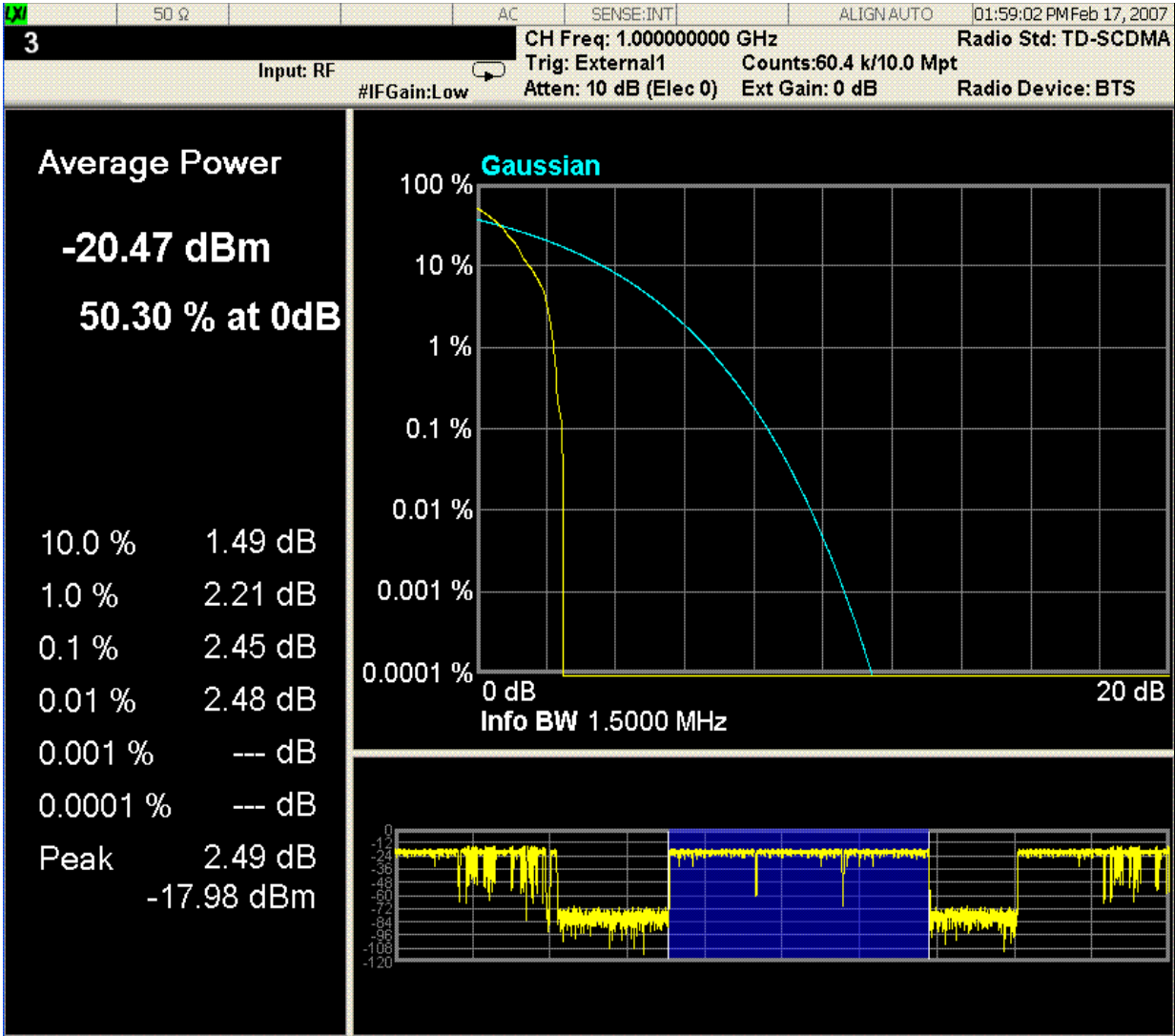

Metrics window

Name	Corresponding Results	Explanation
Average Power [dBm]	n=1 1st Average input power	99.99 dBm
Average Power [%]	n=1 2nd Probability at the average input power level	99.99 %
10.0% [dB]	n=1 3rd Power level that has 10% of the power	99.99 dB
1.0% [dB]	n=1 4th Power level that has 1% of the power	99.99 dB
0.1% [dB]	n=1 5th Power level that has 0.1% of the power	99.99 dB
0.01% [dB]	n=1 6th Power level that has 0.01% of the power	99.99 dB
0.001% [dB]	n=1 7th Power level that has 0.001% of the power	99.99 dB
0.0001% [dB]	n=1 8th Power level that has 0.0001% of the power	99.99 dB
Peak [dB]	n=1 9th Peak power	99.99 dB
Peak[dBm]	This is not available using remote commands.	99.99 dBm

Graph window

Marker Operation	Yes
Corresponding Trace	<p>Yellow: Series of 5001 floating the current measured power stat trace. (n=2) Initially all markers refer this trace.</p> <p>Light Blue: Series of 5001 floating point numbers (in percent) that represent the Gaussian trace. (n=3)</p> <p>Violet: series of 5001 floating point numbers (in percent) that represent the user-definable reference trace. (n=4)</p> <p>The Gaussian and Reference trace/line can be removed using the features under the Trace/Detector key</p>

Wave window (TD-SCDMA only)

This window is only available under TD-SCDMA mode, and by default this window is closed, it could

be turn of/off by soft key "SlotView", refer to section "Slot View (TD-SCDMA only)" on page 747.

Marker Operation	No
Corresponding Trace	Yellow: Wave form of entire TD-SCDMA frame. If measurement range specified by Analysis Time Slot and Measured Time Slot is out of the first frame, the display range will extend to two TD-SCDMA frames. Blue: Indicate current measurement range
Key Path	Front-panel key
Instrument S/W Revision	Prior to A.02.00

Display

Accesses a menu of functions that enable you to set the display parameters...

See "Display" on page 1307 in the "Common Measurement Functions" section for more information.

Key Path	View/Display
Instrument S/W Revision	Prior to A.02.00

Slot View (TD-SCDMA only)

Switch between normal CCDF view and Slot view with additional wave window, this is available only under TD-SCDMA mode.

Key Path	View/Display
Mode	TD-SCDMA
Remote Command	[:SENSE]:PStatistic:SLTView[:STATE] OFF ON 0 1 [:SENSe]:PStatistic: SLTView[:STATE]?
Example	PST:SLTV OFF PST:SLTV?
Preset	OFF
State Saved	Saved in instrument state.
Range	On Off
Instrument S/W Revision	Prior to A.02.00

The Code Domain Measurement provides the code domain analysis of a TD-SCDMA signal. It is an analysis-oriented measurement rather than a conformance test. For more details, see [Code Domain Measurement Description](#) below.

This topic contains the following sections.

[Remote Commands for Code Domain](#)

[Measurement Results for Code Domain Measurement](#)

Remote Commands for Code Domain

The following commands are used to retrieve the measurement results:

The general functionality of CONFigure, FETCh, MEASure, and READ are described at the beginning of this section.

```
:CONFigure:CDPower
```

```
:CONFigure:CDPower:NDEFault
```

```
:FETCh:CDPower [n] ?
```

```
:INITiate:CDPower
```

```
:MEASure:CDPower [n] ?
```

```
:READ:CDPower [n] ?
```

Measurement Results for Code Domain Measurement

For each result, the following heading is used to represent its format and precision.

```
#.Result Name (type of number) [unit] <explanation>
```

Type of number includes double, float and integer.

Index: n	Results Returned
0	Returns unprocessed I/Q trace data, as a series of comma-separated trace points, in volts. The I values are listed first in each pair, using the even-indexed values. The Q values are the odd-indexed values. If no data is captured, one NaN will be returned.

not specified
or n = 1

Returns the following 24 comma-separated scalar results:

NOTE When the measurement fails to get results, such as: failing to in synchronization or the slot under test is DwPTS/UpPTS or inactive, all the following scalar results will be unavailable and return NaN.

1. RMS EVM: (double) [percent]
The RMS-averaged EVM of de-spreaded symbols in the specified code (spreading code length and code channel), timeslot and sub-frame.
2. Peak EVM: (double) [percent]
The peak symbol EVM in the specified code (spreading code length and code channel), timeslot and sub-frame.
3. Peak position of peak EVM: (float) [symbol]
The index of symbol which has the maximum EVM in the specified code channel, timeslot and sub-frame.
4. Rms Mag Error: (double) [percent]
The RMS-averaged magnitude error of de-spreaded symbols in the specified code (spreading code length and code channel), timeslot and sub-frame.
5. Peak Mag Error: (double) [percent]
The peak symbol Mag Error in the specified code (spreading code length and code channel), timeslot and sub-frame.
6. Peak position of peak Mag Error: (float) [symbol]
The index of symbol which has the maximum magnitude error in the specified code channel, timeslot and sub-frame.
7. Rms Phase Error: (double) [deg]
The RMS-averaged phase error of de-spreaded symbols in the specified code (spreading code length and code channel), timeslot and sub-frame.
8. Peak Phase Error: (double) [deg]
The peak symbol Phase Error in the specified code (spreading code length and code channel), timeslot and sub-frame.
9. Peak position of peak phase Error: (float) [symbol]
10. Code Phase Error: (double) [deg]
The phase offset of the code channel relative to the DwPTS pilot time slot.
The index of symbol which has the with maximum phase error in the specified code channel, timeslot and sub-frame.
11. Number of Active Channels: (float) [NA]
The number of active channels in the specified timeslot and sub-frame.

not specified
or n = 1

(Continued)

12. Total Data Power: (double) [dBm]

The total data power of the selected timeslot and sub-frame. It is the power used to normalize CDP and CDE.

13. Code Domain Power(dBm): (double) [dBm]

The absolute signal power of specified code channel.

14. Code Domain Power(dB): (double) [dB]

The signal power of specified code channel normalized to the total signal power.

15. Code Domain Error (dBm): (double) [dBm]

The code domain error of the specified code channel.

16. Code Domain Error(dB): (double) [dB]

The code domain error of the specified code channel.

17. Peak Active CDE (double) [dB]

The peak CDE in dB among the active channel in the specified timeslot.

18. Spreading Code Length of Peak Active CDE: (float) [NA]

The spreading code length of peak active CDE in the specified timeslot and sub-frame.

19. Code Channel No. of Peak Active CDE: (float) [NA]

The code channel No. of peak active CDE in the specified timeslot and sub-frame.

20. Peak CDE (double) [dB]

The peak CDE in dB among all the channel in the specified timeslot.

21. Spreading Code Length of Peak CDE: (float) [NA]

The spreading code length of peak CDE in the specified timeslot and sub-frame.

22. Code Channel No. of Peak CDE: (float) [NA]

The code channel No. of peak CDE in the specified timeslot and sub-frame.

23. Number of Midamble Shifts: (float) [NA]

The number of midamble shifts detected in the specified timeslot.

24. Mod Detection: (float)[NA]

The modulation mod has been detected. 0 stands for QPSK, 1 stands for 8PSK, 2 stands for 16QAM and 3 for 64QAM.

2 Code Length Vector (float) [NA]

Return the vector containing information of the spreading code length of each code channel, active or inactive, in the specified timeslot.

There are 16 numbers in this vector. When composite is ON, the code lengths in the vector are determined by the code length of all active channels and set to 16 for the inactive channels. When composite is OFF, the code lengths are all the same to be the spread code length in display.

If the code length is less than the max spreading code length 16, the length value in the vector is duplicated (16/spreading code length) times. The purpose of this vector is providing the code length information for each value in Active Flag Vector, Un-normalized Code Domain Power Vector, Normalized Code Domain Power Vector, Un-normalized Code Domain Error Vector, and Normalized Code Domain Error Vector.

Its data are lined according to the increasing code index,

Example:

Configuration1: There are five active code channels in one timeslot, C16(0), C8(1), C16(5), C4(2) and C8(7). Like this,



And the yellow block denotes inactive channel.

So the values in this vector should be {16, 16, 8, 8, 16, 16, 16, 16, 4, 4, 4, 4, 16, 16, 8, 8}.

Note: When the measurement fails to get synchronization or the slot under test is DwPTS/UpPTS or inactive, and so on, 16 NaN will be returned.

3 Active Flag Vector (float) [NA]

Return the vector containing information whether or not the specified channel is active, as a series of comma-separated points. “1” denotes active, and “0” denotes inactive.

There are 16 numbers in this vector. If the channel’s code length (indicated by the value on the same position within the Code Length Vector) is less than the max spreading code length 16, the flag is duplicated (16/spreading code length) times. Its data are lined according to the increasing code index.

Take Configuration 1 for example, the values in this vector should be {1, 0, 1, 1, 0, 1, 0, 0, 1, 1, 1, 1, 0, 0, 1, 1}.

Note: When the measurement fails to get synchronization or the slot under test is DwPTS/UpPTS or inactive, and so on, all the flags in this vector will be 0.0.

4 Unnormalized Code Domain Power Vector (float) [dBm]

Return the vector containing unnormalized CDP information for the specified code channel, as a series of comma-separated points.

There are 16 numbers in this vector. If the channel’s code length (indicated by the value on the same position within the Code Length Vector) is less than the max spreading code length 16, the power is duplicated (16/spreading code length) times. Its data are lined according to the increasing code index.

Take Configuration 1 for example, the values in this vector should be {P1, Px, P2, P2, Px, P3, Px, Px, P4, P4, P4, P4, Px, Px, P5, P5}. Px is the power on code channel C16(x).

Note: When the measurement fails to get the result, such as: failing to in synchronization or the slot under test is DwPTS/UpPTS or inactive, 16 NaN will be returned.

- 5 Normalized Code Domain Power Vector (float) [dB]
- Return the vector containing normalized CDP information for the specified code channel, as a series of comma-separated points.
- There are 16 numbers in this vector. If the channel's code length (indicated by the value on the same position within the Code Length Vector) is less than the max spreading code length 16, the power is duplicated (16/spreading code length) times. Its data are lined according to the increasing code index.
- Take Configuration 1 for example, the values in this vector should be {P1, Px, P2, P2, Px, P3, Px, Px, P4, P4, P4, P4, Px, Px, P5, P5}. Px is the power on code channel C16(x).
-
- Note: When the measurement fails to get the result, such as: failing to in synchronization or the slot under test is DwPTS/UpPTS or inactive, 16 NaN will be returned.
- 6 Unnormalized Code Domain Error Vector (float) [dBm]
- Return the vector containing unnormalized CDE information for the specified code channel, as a series of comma-separated points.
- There are 16 numbers in this vector. If the channel's code length (indicated by the value on the same position within the Code Length Vector) is less than the max spreading code length 16, the error is duplicated (16/spreading code length) times. Its data are lined according to the increasing code index.
- Take Configuration 1 for example, the values in this vector should be {E1, Ex, E2, E2, Ex, E3, Ex, Ex, E4, E4, E4, E4, Ex, Ex, E5, E5}. Ex is the power on code channel C16(x).
- Note: When the measurement fails to get the result, such as: failing to in synchronization or the slot under test is DwPTS/UpPTS or inactive, 16 NaN will be returned.
- 7 Normalized Code Domain Error Vector (float) [dB]
- Return the vector containing normalized CDE information for the specified code channel, as a series of comma-separated points.
- There are 16 numbers in this vector. If the active channel's code length (specified by the value on the same position within the Code Length Vector) is less than the max spreading code length 16, the error is duplicated (16/spreading code length) times. Its data are lined according to the increasing code index.
- Take Configuration 1 for example, the values in this vector should be {E1, Ex, E2, E2, Ex, E3, Ex, Ex, E4, E4, E4, E4, Ex, Ex, E5, E5}. Ex is the power on code channel C16(x).
- Note: When the measurement fails to get the result, such as: failing to in synchronization or the slot under test is DwPTS/UpPTS or inactive, 16 NaN will be returned.
- 8 Symbol Magnitude Error Vector (float) [percent]
- Return symbol magnitude error vector for the specified code channel and spread code length, as a series of comma-separated points.
- The length of the vector depends on the number of symbols in the code channel. The maximum length is 704.
- Note: When the measurement fails to get the result, such as: failing to in synchronization or the slot under test is DwPTS/UpPTS or inactive, one NaN will be returned.

- 9 Symbol Phase Error Vector (float) [deg]
- Return symbol phase error vector for the specified code channel and spread code length, as a series of comma-separated points.
- The length of the vector depends on the number of symbols in the code channel. The maximum length is 704.
- Note: When the measurement fails to get the result, such as: failing to in synchronization or the slot under test is DwPTS/UpPTS or inactive, one NaN will be returned.
- 10 Symbol EVM Vector (float) [percent]
- Return symbol EVM vector for the specified code channel and spread code length, as a series of comma-separated points.
- The length of the vector depends on the number of symbols in the code channel. The maximum length is 704.
- Note: When the measurement fails to get the result, such as: failing to in synchronization or the slot under test is DwPTS/UpPTS or inactive, one NaN will be returned.
- 11 Unnormalized I/Q Symbol Polar Vector (float) [volts]
- Return unnormalized I/Q data of demod symbols in the specified code channel (Code Length) and code layer (Spread Code Length), as a series of comma-separated points. The I values are listed first in each pair, using the 0 through even-indexed values. The Q values are the odd-indexed values.
- The length of the vector depends on the number of symbols in the code channel.
- Note: When the measurement fails to get the result, such as: failing to in synchronization or the slot under test is DwPTS/UpPTS or inactive, one NaN will be returned.
- 12 Normalized I/Q Symbol Polar Vector (float) [NA]
- Return normalized I/Q data of demod symbols in the specified code channel (Code Length) and code layer (Spread Code Length), as a series of comma-separated points. The I values are listed first in each pair, using the 0 through even-indexed values. The Q values are the odd-indexed values.
- The length of the vector depends on the number of symbols in the code channel.
- Note: When the measurement fails to get the result, such as: failing to in synchronization or the slot under test is DwPTS/UpPTS or inactive, one NaN will be returned.
- 13 Symbol Power Vector (float) [dBm]
- Return symbol power vector for the specified code channel and spread code length, as a series of comma-separated points.
- The length of the vector depends on the number of symbols in the code channel.
- Note: When the measurement fails to get the result, such as: failing to in synchronization or the slot under test is DwPTS/UpPTS or inactive, one NaN will be returned.

- 14 Demod Bits Vector (float) [NA]
- Return the vector containing the demod binary bits for each symbol in the specified code channel, as a series of comma-separated trace points.
- The length depends on the number of bits in the specified code channel.
- Note: When the measurement fails to get the result, such as: failing to in synchronization or the slot under test is DwPTS/UpPTS or inactive, this vector will be unavailable, and one NaN will be returned.
- 15 Midamble Shift Vector (float) [NA]
- Return the vector containing the midamble shift detected in the specified timeslot, as a series of comma-separated trace points.
- The length depends on the number of detected midamble shifts in the specified timeslot, it can be gotten by querying the scalar result [24], Number of User.
- Note: When there is no midamble shift existing in the analyzed timeslot, or when the measurement fails to get the result, such as: failing to in synchronization or the slot under test is DwPTS/UpPTS or inactive, this vector will be unavailable, and one NaN will be returned.

Code Domain Measurement Description

Code Domain measurement provides all the properties/methods for demodulating and analyzing a 3GPP N-TDD 1.28Mcps, TD-SCDMA, modulated signal according to the user specified sub-frame, time slot, code channel and spread code length. It can descramble, despread and demodulate TD-SCDMA modulated signals both uplink and downlink directions to provide the power data and error data for an individual code channel and layer for a specified timeslot and sub-frame. These results comprise of Channel EVM, Channel Magnitude Error, Channel Phase Error, Channel Code Phase Error, Modulation Format, Channel CDP and Channel CDE.

Key Path	Front-panel key
Instrument S/W Revision	A.01.60 or later

Amplitude (AMPTD) Y Scale

The AMPLITUDE Y Scale key accesses the menu to set the desired vertical scale and associated settings.

Default numbers are independent for each window.

See “[Amplitude Y Scale \(AMPTD Y Scale\)](#)” on page 1037 in the "Common Measurement Functions" for more information.

Key Path	Front-panel key
Instrument S/W Revision	A.01.60 or later

Ref Value

This key allows you to set the display reference. Since the Auto Scaling is defaulted to On, this value is automatically determined by the measurement result. When you set a value manually, Auto Scaling automatically changes to Off.

This key is only available in Code Domain EVM Window, Code Domain Mag Error Window, Code Domain Phase Error Window, Code Domain Power Window, Code Domain Error Window and Code Domain Symbol Power Window.

Key Path	AMPTD Y Scale
Instrument S/W Revision	A.01.60 or later

Y Ref Value (I/Q Error View – Code Domain Mag Error Window)

This key sets the reference value in the Code Domain Mag Error window.

Remote Command	:DISPlay:CDPower:VIEW3:WINDow [1] :TRACe:Y[:SCALE] :RLEVel <real> :DISPlay:CDPower:VIEW3:WINDow [1] :TRACe:Y[:SCALE] :RLEVel ?
Dependencies/Couplings	See Restriction and Notes
Example	DISP:CDP:VIEW3:WIND:TRAC:Y:RLEV 0.0 DISP:CDP:VIEW3:WIND:TRAC:Y:RLEV?
Key Path	AMPTD Y Scale
Mode	TD-SCDMA

Notes	If Auto Scale is set to On, this value is automatically determined by the measurement result. When you set this value manually, Auto Scale is automatically set to Off. VIEW3: I/Q Error View WINDow[1]: Code Domain Mag Error Window on I/Q Error View
Preset	0.0
State Saved	Saved in instrument state.
Min	0.0
Max	500.0
Test MIN/MAX/DEF	No
Test UP/DOWN	1, 2, 5, 10
Instrument S/W Revision	A.01.60 or later

Y Ref Value (I/Q Error View –Code Domain Phase Error Window)

This key sets the reference value in the Code Domain Phase Error window.

Remote Command	:DISPlay:CDPower:VIEW3:WINDow2:TRACe:Y[:SCALE]:RLEVel <real> :DISPlay:CDPower:VIEW3:WINDow2:TRACe:Y[:SCALE]:RLEVel?
Dependencies/Couplings	See Restriction and Notes
Example	DISP:CDP:VIEW3:WIND2:TRAC:Y:RLEV 0.0 DISP:CDP:VIEW3:WIND2:TRAC:Y:RLEV?
Key Path	AMPTD Y Scale
Mode	TD-SCDMA
Notes	If Auto Scale is set to On, this value is automatically determined by the measurement result. When you set this value manually, Auto Scale is automatically set to Off. VIEW3 : I/Q Error View WINDow2: Code Domain Phase Error Window on I/Q Error View
Preset	0.0
State Saved	Saved in instrument state.
Min	0.0
Max	10000.0
Test MIN/MAX/DEF	No
Test UP/DOWN	1, 2, 5, 10

Code Domain Measurement
Amplitude (AMPTD) Y Scale

Instrument S/W Revision A.01.60 or later

Y Ref Value (I/Q Error View – Code Domain EVM Window)

This key sets the reference value in the Code Domain EVM window.

Remote Command	:DISPlay:CDPower:VIEW3:WINDow3:TRACe:Y[:SCALe]:RLEVel <real> :DISPlay:CDPower:VIEW3:WINDow3:TRACe:Y[:SCALe]:RLEVel?
Dependencies/Couplings	See Restriction and Notes
Example	DISP:CDP:VIEW3:WIND3:TRAC:Y:RLEV 0.0 DISP:CDP:VIEW3:WIND3:TRAC:Y:RLEV?
Key Path	AMPTD Y Scale
Mode	TD-SCDMA
Notes	If Auto Scale is set to On, this value is automatically determined by the measurement result. When you set this value manually, Auto Scale is automatically set to Off. VIEW3 : I/Q Error View WINDow3: Code Domain EVM Window on I/Q Error View
Preset	0.0
State Saved	Saved in instrument state.
Min	0.0
Max	500.0
Test MIN/MAX/DEF	No
Test UP/DOWN	1, 2, 5, 10
Instrument S/W Revision	A.01.60 or later

Y Ref Value (Code Domain Symbol Power Window)

This key sets the reference value in the Code Domain Symbol Power window.

Remote Command	:DISPlay:CDPower:VIEW4 5 : WINDow2 : TRACe : Y [: SCALe] : RLEVel <real> :DISPlay:CDPower:VIEW4 5 : WINDow2 : TRACe : Y [: SCALe] : RLEVel ?
Dependencies/Couplings	See Restriction and Notes

Example	DISP:CDP:VIEW4:WIND2:TRAC:Y:RLEV 0.0 DISP:CDP:VIEW4:WIND2:TRAC:Y:RLEV? DISP:CDP:VIEW5:WIND2:TRAC:Y:RLEV 0.0 DISP:CDP:VIEW5:WIND2:TRAC:Y:RLEV?
Key Path	AMPTD Y Scale
Mode	TD-SCDMA
Notes	If Auto Scale is set to On, this value is automatically determined by the measurement result. When you set this value manually, Auto Scale is automatically set to Off. VIEW4 : Code Domain View VIEW5 : Demod Bits View WINDow2: Code Domain Symbol Power Window on Code Domain View or Demod Bits View
Preset	0.0
State Saved	Saved in instrument state.
Min	-250.0
Max	250.0
Test MIN/MAX/DEF	No
Test UP/DOWN	1, 2, 5, 10
Instrument S/W Revision	A.01.60 or later

Y Ref Value (Code Domain Power Window)

This key sets the power reference value for the power results in the Code Domain Power window.

Remote Command	:DISPlay:CDPower:VIEW [1] 4 5 :WINDow [1] :TRACe:Y [:SCALE] :RLEVel <real> :DISPlay:CDPower:VIEW [1] 4 5 :WINDow [1] :TRACe:Y [:SCALE] :RLEVel?
Example	DISP:CDP:VIEW:WIND:TRAC:Y:RLEV 0.0 DISP:CDP:VIEW:WIND:TRAC:Y:RLEV? DISP:CDP:VIEW4:WIND:TRAC:Y:RLEV 0.0 DISP:CDP:VIEW4:WIND:TRAC:Y:RLEV? DISP:CDP:VIEW5:WIND:TRAC:Y:RLEV 0.0 DISP:CDP:VIEW5:WIND:TRAC:Y:RLEV?
Key Path	AMPTD Y Scale
Mode	TD-SCDMA

Code Domain Measurement
Amplitude (AMPTD) Y Scale

Notes	<p>If Auto Scale is set to On, this value is automatically determined by the measurement result. When you set this value manually, Auto Scale is automatically set to Off.</p> <p>Couple with Normalize: If Normalize is On, the Unit is dB; Otherwise, the Unit is dBm</p> <p>VIEW[1] : CDP Graph and Metrics View</p> <p>VIEW4 : Code Domain View</p> <p>VIEW5 : Demod Bits View</p> <p>WINDow[1]: Code Domain Power Window on CDP Graph and Metrics View or Code Domain View, Demod Bits View</p>
Preset	0.0
State Saved	Saved in instrument state.
Min	-250.0
Max	250.0
Test MIN/MAX/DEF	No
Test UP/DOWN	1, 2, 5, 10
Instrument S/W Revision	A.01.60 or later

Y Ref Value (Code Domain Error Window)

This key sets the power reference value for the power results in the Code Domain Error window.

Remote Command	<pre>:DISPlay:CDPower:VIEW2:WINDow[1]:TRACe:Y[:SCALE]:RLEVel <real> :DISPlay:CDPower:VIEW2:WINDow[1]:TRACe:Y[:SCALE]:RLEVel ?</pre>
Example	<pre>DISP:CDP:VIEW2:WIND:TRAC:Y:RLEV 0.0 DISP:CDP:VIEW2:WIND:TRAC:Y:RLEV?</pre>
Key Path	AMPTD Y Scale
Mode	TD-SCDMA
Notes	<p>If Auto Scale is set to On, this value is automatically determined by the measurement result. When you set this value manually, Auto Scale is automatically set to Off.</p> <p>Couple with Normalize: If Normalize is On, the Unit is dB; Otherwise, the Unit is dBm</p> <p>VIEW2 : CDE Graph and Metrics View</p> <p>WINDow[1]: Code Domain Error windows on CDE Graph and Metrics View</p>
Preset	0.0

State Saved	Saved in instrument state.
Min	-250.0
Max	250.0
Test MIN/MAX/DEF	No
Test UP/DOWN	1, 2, 5, 10
Instrument S/W Revision	A.01.60 or later

Attenuation

Operation of this key is identical across several measurements. For details about this key, see [“Attenuation” on page 1037](#) in the "Common Measurement Functions".

Range

This key is available when you have installed Option BBA (BBIQ hardware).

Operation of this key is identical across several measurements. For details about this key, see [“Range” on page 1043](#) in the "Common Measurement Functions".

Scale/Div

This key allows you to enter a numeric value to change the vertical display sensitivity.

This key is only available in Code Domain EVM Window, Code Domain Mag Error Window, Code Domain Phase Error Window, Code Domain Power Window, Code Domain Error Window and Code Domain Symbol Power Window.

Key Path	AMPTD Y Scale
Instrument S/W Revision	A.01.60 or later

Y Scale/Div (I/Q Error View – Code Domain Mag Error Window)

This key sets the sensitivity of measurement result in the Code Domain Mag Error window.

Remote Command	:DISPlay:CDPower:VIEW3:WINDow[1]:TRACe:Y[:SCALe]:PDIVis ion <real> :DISPlay:CDPower:VIEW3:WINDow[1]:TRACe:Y[:SCALe]:PDIVis ion?
Dependencies/Couplings	See Restriction and Notes
Example	DISP:CDP:VIEW3:WIND:TRAC:Y:PDIV 10.0 DISP:CDP:VIEW3:WIND:TRAC:Y:PDIV?
Key Path	AMPTD Y Scale
Mode	TD-SCDMA

Code Domain Measurement
Amplitude (AMPTD) Y Scale

Notes	If Auto Scale is set to On, this value is automatically determined by the measurement result. When you set this value manually, Auto Scale is automatically set to Off. VIEW3: I/Q Error View WINDow[1]: Code Domain Mag Error Window on I/Q Error View
Preset	0.1
State Saved	Saved in instrument state.
Min	0.1
Max	50.0
Test MIN/MAX/DEF	No
Test UP/DOWN	1, 2, 5, 10
Instrument S/W Revision	A.01.60 or later

Y Scale/Div (I/Q Error View – Code Domain Phase Error Window)

This key sets the sensitivity of measurement result in the Code Domain Phase Error window.

Remote Command	:DISPlay:CDPower:VIEW3:WINDow2:TRACe:Y[:SCALE]:PDIVision <real> :DISPlay:CDPower:VIEW3:WINDow2:TRACe:Y[:SCALE]:PDIVision?
Dependencies/Couplings	See Restriction and Notes
Example	DISP:CDP:VIEW3:WIND2:TRAC:Y:PDIV 10.0 DISP:CDP:VIEW3:WIND2:TRAC:Y:PDIV?
Key Path	AMPTD Y Scale
Mode	TD-SCDMA
Notes	If Auto Scale is set to On, this value is automatically determined by the measurement result. When you set this value manually, Auto Scale is automatically set to Off. VIEW3 : I/Q Error View WINDow2: Code Domain Phase Error Window on I/Q Error View
Preset	0.1
State Saved	Saved in instrument state.
Min	0.1
Max	1000.0
Test MIN/MAX/DEF	No
Test UP/DOWN	1, 2, 5, 10

Instrument S/W Revision A.01.60 or later

Y Scale/Div (I/Q Error View – Code Domain EVM Window)

This key sets the sensitivity of measurement result in the Code Domain EVM window.

Remote Command	:DISPlay:CDPower:VIEW3:WINDow3:TRACe:Y[:SCALe]:PDIVisio n <real> :DISPlay:CDPower:VIEW3:WINDow3:TRACe:Y[:SCALe]:PDIVisio n?
Dependencies/Couplings	See Restriction and Notes
Example	DISP:CDP:VIEW3:WIND3:TRAC:Y:PDIV 10.0 DISP:CDP:VIEW3:WIND3:TRAC:Y:PDIV?
Key Path	AMPTD Y Scale
Mode	TD-SCDMA
Notes	If Auto Scale is set to On, this value is automatically determined by the measurement result. When you set this value manually, Auto Scale is automatically set to Off. VIEW3 : I/Q Error View WINDow3: Code Domain EVM Window on I/Q Error View
Preset	0.1
State Saved	Saved in instrument state.
Min	0.1
Max	50.0
Test MIN/MAX/DEF	No
Test UP/DOWN	1, 2, 5, 10
Instrument S/W Revision	A.01.60 or later

Y Scale/Div (Code Domain Symbol Power Window)

This key sets the sensitivity of measurement result in the Code Domain Symbol Power window.

Remote Command	:DISPlay:CDPower:VIEW4 5:WINDow2:TRACe:Y[:SCALe]:PDIVis ion <rel_ampl> :DISPlay:CDPower:VIEW4 5:WINDow2:TRACe:Y[:SCALe]:PDIVis ion?
Dependencies/Couplings	See Restriction and Notes

Code Domain Measurement
Amplitude (AMPTD) Y Scale

Example	DISP:CDP:VIEW4:WIND2:TRAC:Y:PDIV 10.0 dB DISP:CDP:VIEW4:WIND2:TRAC:Y:PDIV? DISP:CDP:VIEW5:WIND2:TRAC:Y:PDIV 10.0 dB DISP:CDP:VIEW5:WIND2:TRAC:Y:PDIV?
Key Path	AMPTD Y Scale
Mode	TD-SCDMA
Notes	If Auto Scale is set to On, this value is automatically determined by the measurement result. When you set this value manually, Auto Scale is automatically set to Off. VIEW4 : Code Domain View VIEW5 : Demod Bits View WINDow2: Code Domain Symbol Power Window on Code Domain View or Demod Bits View
Preset	10.0
State Saved	Saved in instrument state.
Min	0.1
Max	20.0
Test MIN/MAX/DEF	No
Test UP/DOWN	1, 2, 5, 10
Instrument S/W Revision	A.01.60 or later

Y Scale/Div (Code Domain Power Window)

This key sets the sensitivity of the power results in the Code Domain Power window.

Remote Command	:DISPlay:CDPower:VIEW[1] 4 5:WINDow[1]:TRACe:Y[:SCALE]:PDIVision <rel_ampl> :DISPlay:CDPower:VIEW[1] 4 5:WINDow[1]:TRACe:Y[:SCALE]:PDIVision?
Dependencies/Couplings	See Restriction and Notes
Example	DISP:CDP:VIEW:WIND:TRAC:Y:PDIV 10.0 dB DISP:CDP:VIEW:WIND:TRAC:Y:PDIV? DISP:CDP:VIEW4:WIND:TRAC:Y:PDIV 10.0 dB DISP:CDP:VIEW4:WIND:TRAC:Y:PDIV? DISP:CDP:VIEW5:WIND:TRAC:Y:PDIV 10.0 dB DISP:CDP:VIEW5:WIND:TRAC:Y:PDIV?
Key Path	AMPTD Y Scale

Mode	TD-SCDMA
Notes	If Auto Scale is set to On, this value is automatically determined by the measurement result. When you set this value manually, Auto Scale is automatically set to Off. VIEW[1] : CDP Graph and Metrics View VIEW4 : Code Domain View VIEW5 : Demod Bits View WINDow[1]: Code Domain Power Window on CDP Graph and Metrics View or Code Domain View, Demod Bits View
Preset	10.0
State Saved	Saved in instrument state.
Min	0.1
Max	20.0
Test MIN/MAX/DEF	No
Test UP/DOWN	1, 2, 5, 10
Instrument S/W Revision	A.01.60 or later

Y Scale/Div (Code Domain Error Window)

This key sets the sensitivity of the power results in the Code Domain Error window.

Remote Command	:DISPlay:CDPower:VIEW2:WINDow[1]:TRACe:Y[:SCALE]:PDIVis ion <rel_ampl> :DISPlay:CDPower:VIEW2:WINDow[1]:TRACe:Y[:SCALE]:PDIVis ion?
Dependencies/Couplings	See Restriction and Notes
Example	DISP:CDP:VIEW2:WIND:TRAC:Y:PDIV 10.0 DISP:CDP:VIEW2:WIND:TRAC:Y:PDIV?
Key Path	AMPTD Y Scale
Mode	TD-SCDMA
Notes	If Auto Scale is set to On, this value is automatically determined by the measurement result. When you set this value manually, Auto Scale is automatically set to Off. VIEW2 : CDE Graph and Metrics View WINDow[1]: Code Domain Error windows on CDE Graph and Metrics View
Preset	10.0
State Saved	Saved in instrument state.

Code Domain Measurement Amplitude (AMPTD) Y Scale

Min	0.1
Max	20.0
Test MIN/MAX/DEF	No
Test UP/DOWN	1, 2, 5, 10
Instrument S/W Revision	A.01.60 or later

Presel Center

Operation of this key is identical across several measurements. For details about this key, see [“Presel Center” on page 1049](#) in the "Common Measurement Functions".

Presel Adjust

Operation of this key is identical across several measurements. For details about this key, see [“Preselector Adjust” on page 1050](#) in the "Common Measurement Functions".

Internal Preamp

Operation of this key is identical across several measurements. For details about this key, see [“Internal Preamp” on page 1052](#) in the "Common Measurement Functions".

Ref Position

This key allows you to set the display reference position to either Top, Ctr (center), or Bot (Bottom).

This key is only available in Code Domain EVM Window, Code Domain Mag Error Window, Code Domain Phase Error Window, Code Domain Power Window, Code Domain Error Window and Code Domain Symbol Power Window.

Key Path	AMPTD Y Scale
Instrument S/W Revision	A.01.60 or later

Y Ref Position (I/Q Error View – Code Domain Mag Error Window)

This key sets the reference position of the vertical axis in the Code Domain Mag Error window.

Remote Command	<code>:DISPlay:CDPower:VIEW3:WINDow[1]:TRACe:Y[:SCALE]:RPOSit ion TOP CENTer BOTTom</code> <code>:DISPlay:CDPower:VIEW3:WINDow[1]:TRACe:Y[:SCALE]:RPOSit ion?</code>
Example	<code>DISP:CDP:VIEW3:WIND:TRAC:Y:RPOS TOP</code> <code>DISP:CDP:VIEW3:WIND:TRAC:Y:RPOS?</code>
Key Path	AMPTD Y Scale
Mode	TD-SCDMA

Notes	VIEW3: I/Q Error View WINDow[1]: Code Domain Mag Error Window on I/Q Error View
Preset	CENTer
State Saved	Saved in instrument state.
Range	Top Ctr Bot
Instrument S/W Revision	A.01.60 or later

Y Ref Position (I/Q Error View – Code Domain Phase Error Window)

This sets the reference position of the vertical axis in the Code Domain Phase Error window.

Remote Command	:DISPlay:CDPower:VIEW3:WINDow2:TRACe:Y[:SCALE]:RPOSITio n TOP CENTer BOTTom :DISPlay:CDPower:VIEW3:WINDow2:TRACe:Y[:SCALE]:RPOSITio n?
Example	DISP:CDP:VIEW3:WIND2:TRAC:Y:RPOS TOP DISP:CDP:VIEW3:WIND2:TRAC:Y:RPOS?
Key Path	AMPTD Y Scale
Mode	TD-SCDMA
Notes	VIEW3 : I/Q Error View WINDow2: Code Domain Phase Error Window on I/Q Error View
Preset	CENTer
State Saved	Saved in instrument state.
Range	Top Ctr Bot
Instrument S/W Revision	A.01.60 or later

Y Ref Position (I/Q Error View – Code Domain EVM Window)

This key sets the reference position of the vertical axis in the Code Domain EVM window.

Remote Command	:DISPlay:CDPower:VIEW3:WINDow3:TRACe:Y[:SCALE]:RPOSITio n TOP CENTer BOTTom :DISPlay:CDPower:VIEW3:WINDow3:TRACe:Y[:SCALE]:RPOSITio n?
Example	DISP:CDP:VIEW3:WIND3:TRAC:Y:RPOS TOP DISP:CDP:VIEW3:WIND3:TRAC:Y:RPOS?
Key Path	AMPTD Y Scale
Mode	TD-SCDMA

Code Domain Measurement
Amplitude (AMPTD) Y Scale

Notes	VIEW3 : I/Q Error View WINDow3: Code Domain EVM Window on I/Q Error View
Preset	BOTTom
State Saved	Saved in instrument state.
Range	Top Ctr Bot
Instrument S/W Revision	A.01.60 or later

Y Ref Position (Code Domain Symbol Power Window)

This key sets the reference position of the vertical axis in the Code Domain Symbol Power window.

Remote Command	:DISPlay:CDPower:VIEW4 5:WINDow2:TRACe:Y[:SCALE]:RPOSit ion TOP CENTer BOTTom :DISPlay:CDPower:VIEW4 5:WINDow2:TRACe:Y[:SCALE]:RPOSit ion?
Example	DISP:CDP:VIEW4:WIND2:TRAC:Y:RPOS TOP DISP:CDP:VIEW4:WIND2:TRAC:Y:RPOS? DISP:CDP:VIEW5:WIND2:TRAC:Y:RPOS TOP DISP:CDP:VIEW5:WIND2:TRAC:Y:RPOS?
Key Path	AMPTD Y Scale
Mode	TD-SCDMA
Notes	VIEW4 : Code Domain View VIEW5 : Demod Bits View WINDow2: Code Domain Symbol Power Window on Code Domain View or Demod Bits View
Preset	CENTer
State Saved	Saved in instrument state.
Range	Top Ctr Bot
Instrument S/W Revision	A.01.60 or later

Y Ref Position (Code Domain Power Window)

This key sets the reference position of the vertical in the Code Domain Power window.

Remote Command	:DISPlay:CDPower:VIEW[1] 4 5:WINDow[1]:TRACe:Y[:SCALE]: RPOSition TOP CENTER BOTTom :DISPlay:CDPower:VIEW[1] 4 5:WINDow[1]:TRACe:Y[:SCALE]: RPOSition?
----------------	---

Example	DISP:CDP:VIEW:WIND:TRAC:Y:RPOS TOP DISP:CDP:VIEW:WIND:TRAC:Y:RPOS? DISP:CDP:VIEW4:WIND:TRAC:Y:RPOS TOP DISP:CDP:VIEW4:WIND:TRAC:Y:RPOS? DISP:CDP:VIEW5:WIND:TRAC:Y:RPOS TOP DISP:CDP:VIEW5:WIND:TRAC:Y:RPOS?
Key Path	AMPTD Y Scale
Mode	TD-SCDMA
Notes	VIEW[1] : CDP Graph and Metrics View VIEW4 : Code Domain View VIEW5 : Demod Bits View WINDOW[1]: Code Domain Power Window on CDP Graph and Metrics View or Code Domain View, Demod Bits View
Preset	TOP
State Saved	Saved in instrument state.
Range	Top Ctr Bot
Instrument S/W Revision	A.01.60 or later

Y Ref Position (Code Domain Error Window)

This key sets the reference position of the vertical in the Code Domain Error window.

Remote Command	:DISPlay:CDPower:VIEW2:WINDOW[1]:TRACe:Y[:SCALE]:RPOSIT ion TOP CENTer BOTTom :DISPlay:CDPower:VIEW2:WINDOW[1]:TRACe:Y[:SCALE]:RPOSIT ion?
Example	DISP:CDP:VIEW2:WIND:TRAC:Y:RPOS TOP DISP:CDP:VIEW2:WIND:TRAC:Y:RPOS?
Key Path	AMPTD Y Scale
Mode	TD-SCDMA
Notes	VIEW2 : CDE Graph and Metrics View WINDOW[1]: Code Domain Error windows on CDE Graph and Metrics View
Preset	TOP
State Saved	Saved in instrument state.
Range	Top Ctr Bot
Instrument S/W Revision	A.01.60 or later

Auto Scale

This key allows you to toggle the scale coupling function between On and Off.

NOTE This key is only available in Code Domain EVM Window, Code Domain Mag Error Window, Code Domain Phase Error Window, Code Domain Power Window, Code Domain Error Window and Code Domain Symbol Power Window.

When you set a value to either Scale/Div or Ref Value manually, Auto Scaling automatically changes to Off.

Key Path	AMPTD Y Scale
Instrument S/W Revision	A.01.60 or later

Y Auto Scaling (I/Q Error View – Code Domain Mag Error Window)

When Auto Scale is On, it will result in automatically displaying the scale per division and reference value results for the vertical axis in the Code Domain Mag Error window.

Remote Command	:DISPlay:CDPower:VIEW3:WINDow[1]:TRACe:Y[:SCALE]:COUPl e 0 1 OFF ON :DISPlay:CDPower:VIEW3:WINDow[1]:TRACe:Y[:SCALE]:COUPl e ?
Dependencies/Couplings	See Restriction and Notes
Example	DISP:CDP:VIEW3:WIND:TRAC:Y:COUP ON DISP:CDP:VIEW3:WIND:TRAC:Y:COUP?
Key Path	AMPTD Y Scale
Mode	TD-SCDMA
Notes	When this parameter is set to On, it will activate the scale coupling function that automatically determines scale per division and reference values based on the measurement results. When you set a value to either Scale/Div or Ref Value manually, Auto Scale is automatically set to Off. VIEW3: I/Q Error View WINDow[1]: Code Domain Mag Error Window on I/Q Error View
Preset	ON
State Saved	Saved in instrument state.
Range	On Off
Instrument S/W Revision	A.01.60 or later

Y Auto Scale (I/Q Error View – Code Domain Phase Error Window)

When Auto Scale is On, it will result in automatically displaying the scale per division and reference

value results for the vertical axis in the Code Domain Phase Error window.

Remote Command	:DISPlay:CDPower:VIEW3:WINDow2:TRACe:Y[:SCALE]:COUPle 0 1 OFF ON :DISPlay:CDPower:VIEW3:WINDow2:TRACe:Y[:SCALE]:COUPle?
Dependencies/Couplings	See Restriction and Notes
Example	DISP:CDP:VIEW3:WIND2:TRAC:Y:COUP ON DISP:CDP:VIEW3:WIND2:TRAC:Y:COUP?
Key Path	AMPTD Y Scale
Mode	TD-SCDMA
Notes	When this parameter is set to On, it will activate the scale coupling function that automatically determines scale per division and reference values based on the measurement results. When you set a value to either Scale/Div or Ref Value manually, Auto Scale is automatically set to Off. VIEW3 : I/Q Error View WINDow2: Code Domain Phase Error Window on I/Q Error View
Preset	ON
State Saved	Saved in instrument state.
Range	On Off
Instrument S/W Revision	A.01.60 or later

Y Auto Scale (I/Q Error View – Code Domain EVM Window)

When Auto Scale is On, it will result in automatically displaying the scale per division and reference value results for the vertical axis in Code Domain EVM window.

Remote Command	:DISPlay:CDPower:VIEW3:WINDow3:TRACe:Y[:SCALE]:COUPle 0 1 OFF ON :DISPlay:CDPower:VIEW3:WINDow3:TRACe:Y[:SCALE]:COUPle?
Dependencies/Couplings	See Restriction and Notes
Example	DISP:CDP:VIEW3:WIND3:TRAC:Y:COUP ON DISP:CDP:VIEW3:WIND3:TRAC:Y:COUP?
Key Path	AMPTD Y Scale
Mode	TD-SCDMA

Code Domain Measurement
Amplitude (AMPTD) Y Scale

Notes	When this parameter is set to On, it will activate the scale coupling function that automatically determines scale per division and reference values based on the measurement results. When you set a value to either Scale/Div or Ref Value manually, Auto Scale is automatically set to Off. VIEW3 : I/Q Error View WINDow3: Code Domain EVM Window on I/Q Error View
Preset	ON
State Saved	Saved in instrument state.
Range	On Off
Instrument S/W Revision	A.01.60 or later

Y Auto Scale (Code Domain Symbol Power Window)

When Auto Scale is On, it will result in automatically displaying the scale per division and reference value results for the vertical axis in Code Domain Symbol Power window.

Remote Command	:DISPlay:CDPower:VIEW4 5:WINDow2:TRACe:Y[:SCALE]:COUPlE0 1 OFF ON :DISPlay:CDPower:VIEW4 5:WINDow2:TRACe:Y[:SCALE]:COUPlE?
Dependencies/Couplings	See Restriction and Notes
Example	DISP:CDP:VIEW4:WIND2:TRAC:Y:COUP ON DISP:CDP:VIEW4:WIND2:TRAC:Y:COUP? DISP:CDP:VIEW5:WIND2:TRAC:Y:COUP ON DISP:CDP:VIEW5:WIND2:TRAC:Y:COUP?
Key Path	AMPTD Y Scale
Mode	TD-SCDMA
Notes	When this parameter is set to On, it will activate the scale coupling function that automatically determines scale per division and reference values based on the measurement results. When you set a value to either Scale/Div or Ref Value manually, Auto Scale is automatically set to Off. VIEW4 : Code Domain View VIEW5 : Demod Bits View WINDow2: Code Domain Symbol Power Window on Code Domain View or Demod Bits View
Preset	ON
State Saved	Saved in instrument state.
Range	On Off
Instrument S/W Revision	A.01.60 or later

Y Auto Scale (Code Domain Power Window)

When Auto Scale is On, it will result in automatically displaying the scale per division and reference value results in the Code Domain Power window.

Remote Command	:DISPlay:CDPower:VIEW[1] 4 5 :WINDow [1] :TRACe:Y [:SCALe] : COUPlE 0 1 OFF ON :DISPlay:CDPower:VIEW[1] 4 5 :WINDow [1] :TRACe:Y [:SCALe] : COUPlE?
Dependencies/Couplings	See Restriction and Notes
Example	DISP:CDP:VIEW:WIND:TRAC:Y:COUP ON DISP:CDP:VIEW:WIND:TRAC:Y:COUP? DISP:CDP:VIEW4:WIND:TRAC:Y:COUP ON DISP:CDP:VIEW4:WIND:TRAC:Y:COUP? DISP:CDP:VIEW5:WIND:TRAC:Y:COUP ON DISP:CDP:VIEW5:WIND:TRAC:Y:COUP?
Key Path	AMPTD Y Scale
Mode	TD-SCDMA
Notes	When this parameter is set to On, it will activate the scale coupling function that automatically determines scale per division and reference values based on the measurement results. When you set a value to either Scale/Div or Ref Value manually, Auto Scale is automatically set to Off. VIEW[1] : CDP Graph and Metrics View VIEW4 : Code Domain View VIEW5 : Demod Bits View WINDow[1]: Code Domain Power Window on CDP Graph and Metrics View or Code Domain View, Demod Bits View
Preset	ON
State Saved	Saved in instrument state.
Range	On Off
Instrument S/W Revision	A.01.60 or later

Y Auto Scale (Code Domain Error Window)

When Auto Scale is On, it will result in automatically displaying the scale per division and reference value results in the Code Domain Error window.

Remote Command	:DISPlay:CDPower:VIEW2:WINDow [1] :TRACe:Y [:SCALe] :COUPlE 0 1 OFF ON :DISPlay:CDPower:VIEW2:WINDow [1] :TRACe:Y [:SCALe] :COUPlE ?
----------------	---

Code Domain Measurement
Amplitude (AMPTD) Y Scale

Dependencies/Couplings	See Restriction and Notes
Example	DISP:CDP:VIEW2:WIND:TRAC:Y:COUP ON DISP:CDP:VIEW2:WIND:TRAC:Y:COUP?
Key Path	AMPTD Y Scale
Mode	TD-SCDMA
Notes	When this parameter is set to On, it will activate the scale coupling function that automatically determines scale per division and reference values based on the measurement results. When you set a value to either Scale/Div or Ref Value manually, Auto Scale is automatically set to Off. VIEW2 : CDE Graph and Metrics View WINDow[1]: Code Domain Error windows on CDE Graph and Metrics View
Preset	ON
State Saved	Saved in instrument state.
Range	On Off
Instrument S/W Revision	A.01.60 or later

Auto Couple

Operation of this key is identical across several measurements. For details about this key, see “[AUTO COUPLE](#)” on page 1055 in the “Common Measurement Functions”.

BW

There is no BW functionality supported in the Code Domain measurement.

Key Path	Front-panel key
Instrument S/W Revision	A.01.60 or later

Cont

Operation of this key is identical across several measurements. For details about this key, see “[Cont \(Continuous Measurement/Sweep\)](#)” on page 1059 in the "Common Measurement Functions".

FREQ Channel

Operation of this key is identical across several measurements. For details about this key, see FREQ Channel, [“Frequency/Channel” on page 1061](#) in the "Common Measurement Functions".

Center Freq

Allows you to specify the center frequency of the analyzer. For details about this key, see [“Center Freq” on page 1061](#) in the "Common Measurement Functions".

CF Step

CF Step changes the step size for the center frequency. Sets and gets the step value for center frequency. For details about this key, see [“CF Step” on page 1063](#) in the "Common Measurement Functions".

Carrier Config

Allows you to adjust the carrier config parameters. For details about this key, see [“Carrier Config” on page 863](#).

Input/Output

Operation of this key is identical across several measurements. For details about this key, see [“Input/Output” on page 1065](#) in the "Common Measurement Functions".

Marker

Accesses the menu that allows you to select, set up, and control the markers for the current measurement. Sets the marker control mode as described under **Normal**, **Delta**, and **Off**, below. All interactions and dependencies detailed under the softkey description are enforced when the remote command is sent.

See Marker, “[Marker](#)” on page 1123 for more information.

Key Path	Front Panel Key
Instrument S/W Revision	A.01.60 or later

Select Marker

Accesses a menu that enables you to select, set up and control the markers for the current measurement.

Key Path	Front Panel
Instrument S/W Revision	A.01.60 or later

Marker Type

Sets the marker control mode. If the selected marker is Off, pressing Marker sets it to Normal and places it at the center of the screen on the trace determined by the **Marker Trace** rules. At the same time, reference value of the selected marker appears on the Active Function area.

Active Function Display: Marker X-axis value

Default Active Function: the active function for the selected marker’s current control mode. If the current control mode is Off, there is no active function and the active function is turned off.

The marker X axis value entered in the active function area will display the marker value to its full entered precision.

Sets the marker control mode as described under **Normal**, **Delta** and **Off**, below. All interactions and dependencies detailed under the key description are enforced when the remote command is sent.

Remote Command	:CALCulate:CDPower:MARKer [1] 2 3 4 5 6 7 8 9 10 11 12 :M ODE POSition DELta OFF :CALCulate:CDPower:MARKer [1] 2 3 4 5 6 7 8 9 10 11 12 :M ODE?
Example	CALC:CDP:MARK:MODE POS CALC:CDP:MARK:MODE?
Key Path	Marker
Mode	TD-SCDMA

Notes	<p>If the selected marker is Off, pressing Marker sets it to Normal and places it at the center of the screen on the trace determined by the Marker Trace rules. At the same time, Marker X Axis Value appears on the Active Function area.</p> <p>Default Active Function: the active function for the selected marker's current control mode. If the current control mode is Off, there is no active function and the active function is turned off.</p> <p>Active Function Display: Marker X-axis value</p> <p>the marker X axis value entered in the active function area will display the marker value to its full entered precision.</p> <p>NORMAL is changed to POSition in the new SA.</p>
Preset	OFF
State Saved	Saved in instrument state.
Range	Normal Delta Off
Test MIN/MAX/DEF	Yes
Instrument S/W Revision	A.01.60 or later

Marker Symbol Value

Sets the marker symbol value in the current marker for the trace of I/Q symbol polar trace, EVM trace, Mag Error trace and Phase Error trace. It has no effect if the control mode is **Off**, but is the SCPI equivalent of entering an X value if the control mode is **Normal**.

Remote Command	<pre>:CALCulate:CDPower:MARKer [1] 2 3 4 5 6 7 8 9 10 11 12 :S YMBOL <real></pre> <pre>:CALCulate:CDPower:MARKer [1] 2 3 4 5 6 7 8 9 10 11 12 :S YMBOL?</pre>
Example	<pre>CALC:CDP:MARK:SYMB 1.0</pre> <pre>CALC:CDP:MARK:SYMB?</pre>
Mode	TD-SCDMA
Notes	The query returns the marker's 'symbols' value in the trace if the control mode is Normal The query is returned in 'chips'. If the marker is Off the response is not a number (NAN).
Preset	0
State Saved	No
Min	-9.9E+37
Max	9.9E+37
Test MIN/MAX/DEF	MIN MAX

Test UP/DOWN	10.0
Instrument S/W Revision	A.01.60 or later

Marker X Axis Value (Remote Command only)

Sets the marker X Axis value in the current marker X Axis Scale unit. It has no effect if the control mode is **Off**, but is the SCPI equivalent of entering an X value if the control mode is **Normal** or **Delta**.

Remote Command	:CALCulate:CDPower:MARKer [1] 2 3 4 5 6 7 8 9 10 11 12 :X <real> :CALCulate:CDPower:MARKer [1] 2 3 4 5 6 7 8 9 10 11 12 :X ?
Example	CALC:CDP:MARK3:X 0.0 CALC:CDP:MARK3:X?
Mode	TD-SCDMA
Preset	After a preset, all Markers are turned OFF, so Marker X Axis Value query will return a not a number (NAN).
State Saved	No
Min	ñ9.9E+37
Max	9.9E+37
Test MIN/MAX/DEF	MIN MAX
Test UP/DOWN	Not tested in SCPI test but it is supported.
Instrument S/W Revision	A.01.60 or later

Marker X Axis Position (Remote Command only)

Sets the marker X position in trace points. It has no effect if the control mode is **Off**, but is the SCPI equivalent of entering a value if the control mode is **Normal** or **Delta** - except in trace points rather than X Axis Scale units. The entered value is immediately translated into the current X Axis Scale units for setting the value of the marker.

Remote Command	:CALCulate:CDPower:MARKer [1] 2 3 4 5 6 7 8 9 10 11 12 :X :POSition <real> :CALCulate:CDPower:MARKer [1] 2 3 4 5 6 7 8 9 10 11 12 :X :POSition?
Example	CALC:CDP:MARK10:X:POS 0.0 CALC:CDP:MARK10:X:POS?
Mode	TD-SCDMA

Notes	The query returns the marker's absolute X Axis value in trace points if the control mode is Normal , or the offset from the marker's reference marker in trace points if the control mode is Delta . The value is returned as a real number, not an integer, corresponding to the translation from X Axis Scale units to trace points (see "Fractional Trace Points", above). If the marker is Off the response is not a number.
Preset	After a preset, all Markers are turned OFF, so Marker X Axis Value query will return a not a number (NAN).
State Saved	No
Min	ñ9.9E+37
Max	9.9E+37
Test MIN/MAX/DEF	MIN MAX
Test UP/DOWN	Not tested in SCPI test.
Instrument S/W Revision	A.01.60 or later

Marker Y Axis Value (Remote Command only)

Queries the marker Y Axis value in the current marker Y Axis unit.

Remote Command	:CALCulate:CDPower:MARKer [1] 2 3 4 5 6 7 8 9 10 11 12 :Y ?
Example	CALC:CDP:MARK11:Y?
Mode	TD-SCDMA
Preset	Result dependant on markers setup and signal source
State Saved	No
Test MIN/MAX/DEF	No
Instrument S/W Revision	A.01.60 or later

Properties

Accesses a menu that enables you to select a relative maker and marker trace

Key Path	Marker
Instrument S/W Revision	A.01.60 or later

Select Marker

Accesses a menu that enables you to select, set up and control the markers for the current measurement.

Key Path	Marker, Properties
----------	---------------------------

Code Domain Measurement
Marker

Instrument S/W Revision A.01.60 or later

Relative To

Selects the marker the selected marker will be relative to (its reference marker).

Remote Command :CALCulate:CDPower:MARKer [1] | 2 | 3 | 4 | 5 | 6 | 7 | 8 | 9 | 10 | 11 | 12 :R
EFerence <integer>

:CALCulate:CDPower:MARKer [1] | 2 | 3 | 4 | 5 | 6 | 7 | 8 | 9 | 10 | 11 | 12 :R
EFerence?

Example CALC:CDP:MARK:REF 4
CALC:CDP:MARK:REF?

Key Path **Marker, Properties**

Mode TD-SCDMA

Notes A marker cannot be relative to itself so that choice is grayed out, and if sent from SCPI generates error -221: "Settings conflict; marker cannot be relative to itself."

When queried a single value will be returned (the specified marker numbers relative marker).

A marker cannot be relative to itself so that choice is grayed out, and if sent from SCPI generates error -221: "Settings conflict; marker cannot be relative to itself."

Preset 2|3|4|5|6|7|8|9|10|11|12|1

State Saved Saved in instrument state.

Min 1

Max 12

Test MIN/MAX/DEF Yes

Test UP/DOWN 1

Instrument S/W Revision A.01.60 or later

Marker Trace

Assigns the specified marker to the designated trace.

Remote Command :CALCulate:CDPower:MARKer [1] | 2 | 3 | 4 | 5 | 6 | 7 | 8 | 9 | 10 | 11 | 12 :T
RACe CDPower | CDError | EVM | MERRor | PERRor | SYMPower | POLar

:CALCulate:CDPower:MARKer [1] | 2 | 3 | 4 | 5 | 6 | 7 | 8 | 9 | 10 | 11 | 12 :T
RACe?

Example CALC:CDP:MARK:TRACE EVM
CALC:CDP:MARK:TRACE?

Key Path	Marker,Properties
Mode	TD-SCDMA
Preset	EVM
State Saved	Saved in instrument state.
Range	Code Domain Power Code Domain Error EVM Phase Error Mag Error Code Domain Symbol Power Polar
Test MIN/MAX/DEF	Yes
Instrument S/W Revision	A.01.60 or later

Couple Marker

Toggles the state of the markers to be coupled On or Off. When this function is true (On), moving any marker causes an equal X-axis movement of every other marker except those located to the polar trace, and Chip value of the marker located to the polar trace, which is not **Off**. “Equal X Axis movement” refers to the difference between each marker’s X Axis value (in the fundamental x-axis units of the trace that marker is on) and the X Axis value of the marker being moved (in the same fundamental x-axis units). This may result in markers going offscreen

Remote Command	:CALCulate:CDPower:MARKer:COUple[:STATe] ON OFF 1 0 :CALCulate:CDPower:MARKer:COUple[:STATe]?
Example	CALC:CDP:MARK:COUP ON CALC:CDP:MARK:COUP?
Key Path	Marker
Mode	TD-SCDMA
Preset	OFF
State Saved	Saved in instrument state.
Range	On Off
Test MIN/MAX/DEF	Yes
Instrument S/W Revision	A.01.60 or later

All Markers Off

Turns off all markers.

Remote Command	:CALCulate:CDPower:MARKer:AOFF
Example	CALC:CDP:MARK:AOFF
Key Path	Marker
Mode	TD-SCDMA

Code Domain Measurement
Marker

Instrument S/W Revision A.01.60 or later

Backward Compatibility SCPI Commands

Sets or queries the state of a marker. Setting a marker which is OFF to state ON or 1 puts it in Normal mode and places it at the center of the screen.

Mode	TD-SCDMA
Remote Command	:CALCulate:CDPower:MARKer [1] 2 3 4 5 6 7 8 9 10 11 12 :S TATe OFF ON 0 1 :CALCulate:CDPower:MARKer [1] 2 3 4 5 6 7 8 9 10 11 12 :S TATe?
Preset	OFF
State Saved	Saved in instrument state.
Range	On Off
Example	CALC:CDP:MARK3:STATe ON CALC:CDP:MARK3:STAT?
Instrument S/W Revision	A.01.60 or later

Marker Fctn

There are no Marker Function operations supported in the Code Domain measurement. The front-panel key will display a blank menu when pressed.

Key Path	Front panel key
Instrument S/W Revision	A.01.60 or later

Marker To

There are no Marker To operations supported in the Code Domain measurement. The front-panel key will display a blank menu when pressed.

Key Path	Front panel key
Instrument S/W Revision	A.01.60 or later

Meas

Operation of this key is identical across several measurements. For details about this key, see [“Meas” on page 1127](#) in the "Common Measurement Functions".

Meas Setup

This menu displays the measurement setup menu for the Code Domain Measurement when the **Code Domain** Measurement key has been selected in the Measure menu.

Key Path	Front panel key
Instrument S/W Revision	A.01.60 or later

Result Length

Sets and gets the result length in terms of sub-frames. It is the number of sub-frames user intends to analyze. For example, when it is necessary to estimate the S1/S2 phase on DwPTS, Result Length should be set to a number no less than 4.

Remote Command	<code>[:SENSE] :CDPower:RINTerval <integer></code> <code>[:SENSE] :CDPower:RINTerval?</code>
Example	<code>:CDP:RINT 1</code> <code>:CDP:RINT?</code>
Key Path	Meas Setup
Mode	TD-SCDMA
Preset	1
State Saved	Saved in instrument state.
Min	1
Max	12
Test MIN/MAX/DEF	Yes
Instrument S/W Revision	A.01.60 or later

Analysis Subframe

Specifies which sub-frames, within the acquired Result Length, is used for analysis and trace data measurement results. The available selections should include the acquired sub-frames. If the specified sub-frame is larger than the number of sub-frames within the Result Length, the Analysis Sub-frame will be specified the last sub-frame within the Result Length.

Remote Command	<code>[:SENSE] :CDPower:ANALysis:SUBFrame <integer></code> <code>[:SENSE] :CDPower:ANALysis:SUBFrame?</code>
----------------	---

Dependencies/Couplings	Coupling with the Result Length. Analysis Subframe should be less than Result Length. IF(Analysis Subframe >= Result Length) Analysis Subframe = (Result Length – 1); ENDIF
Example	:CDP:ANAL:SUBF 0 :CDP:ANAL:SUBF?
Key Path	Meas Setup
Mode	TD-SCDMA
Preset	0
State Saved	Saved in instrument state.
Min	0
Max	See Coupling
Test MIN/MAX/DEF	Yes
Test UP/DOWN	1
Instrument S/W Revision	A.01.60 or later

Spread Code Length

Lets you set the Spread Code Length. The Spread Code Length is used along with the Code Channel to specify the active code layer and channel used for the measurement results (including: IQ Meas Time, Mag Error, Phase Error and Symbol trace or Error trace data results).

Remote Command	[:SENSE] :CDPower:SCLength <integer> [:SENSE] :CDPower:SCLength?
Dependencies/Couplings	Only 1, 2, 4, 8, 16 are valid and any number will be clipped to the nearest valid number.
Example	:CDP:SCL 1 :CDP:SCL?
Key Path	Meas Setup
Mode	TD-SCDMA
Preset	16
State Saved	Saved in instrument state.
Min	1
Max	16

Code Domain Measurement Meas Setup

Test MIN/MAX/DEF	Yes
Test UP/DOWN	1, 2, 4, 8
Instrument S/W Revision	A.01.60 or later

Code Channel

Lets you set the Code Channel to be analyzed. The Code Channel is used along with the Spread Code Length to specify the active code channel and layer used for the measurement results (Including: IQ Meas Time, Mag Error, Phase Error and Symbol trace or Error trace data results).

Remote Command	<code>[:SENSE] :CDPower:CDChannel <integer></code> <code>[:SENSE] :CDPower:CDChannel?</code>
Dependencies/Couplings	This value only can be set to 0~ Spread Code Length-1.
Example	<code>:CDP:CDCH 1</code> <code>:CDP:CDCH?</code>
Key Path	Meas Setup
Mode	TD-SCDMA
Preset	0
State Saved	Saved in instrument state.
Min	0
Max	Equals (Spread Code Length – 1)
Test MIN/MAX/DEF	No
Test UP/DOWN	2
Instrument S/W Revision	A.01.60 or later

Meas Preset

This will set the measure setup parameters for the currently selected measurement only, to the factory defaults.

Remote Command	<code>:CONFigure:CDPower</code>
Dependencies/Couplings	Selecting measurement preset will restore all measurement parameters to their default values for the current measurement.
Example	<code>:CONFigure:CDPower</code>
Key Path	Meas Setup
Mode	TD-SCDMA
Instrument S/W Revision	A.01.60 or later

Mode

Operation of this key is identical across several measurements. For details about this key, see [“Mode” on page 1145](#) in the "Common Measurement Functions".

Mode Setup

Operation of this key is identical across several measurements. For details about this key, see “[Mode Setup](#)” on page 1159 in the “Common Measurement Functions”.

Peak Search

Accesses a menu that enables you to control the peak search function and places a marker on the trace point with highest peak.

Peak Search

Places the selected marker on the trace point with the maximum y-axis value for that marker's trace.

Remote Command	:CALCulate:CDPower:MARKer [1] 2 3 4 5 6 7 8 9 10 11 12 :MAXimum
Example	CALC:CDP:MARK2:MAX
Key Path	Front panel key
Mode	TD-SCDMA
Instrument S/W Revision	A.01.60 or later

Next Peak

Moves the selected marker to the peak that has the next highest amplitude less than the marker's current value.

Remote Command	:CALCulate:CDPower:MARKer [1] 2 3 4 5 6 7 8 9 10 11 12 :MAXimum:NEXT
Example	CALC:CDP:MARK2:MAX:NEXT
Key Path	Peak Search
Mode	TD-SCDMA
Instrument S/W Revision	A.01.60 or later

Next Pk Right

Moves the selected marker to the nearest peak right of the current marker which meets all enabled peak criteria.

Remote Command	:CALCulate:CDPower:MARKer [1] 2 3 4 5 6 7 8 9 10 11 12 :MAXimum:RIGHT
Example	CALC:CDP:MARK2:MAX:RIGH
Key Path	Peak Search
Mode	TD-SCDMA
Instrument S/W Revision	A.01.60 or later

Next Pk Left

Moves the selected marker to the nearest peak left of the current marker which meets all enabled peak criteria.

Remote Command	:CALCulate:CDPower:MARKer [1] 2 3 4 5 6 7 8 9 10 11 12 :M AXimum:LEFT
Example	CALC:CDP:MARK2:MAX:LEFT
Key Path	Peak Search
Mode	TD-SCDMA
Instrument S/W Revision	A.01.60 or later

Marker Delta

Sets the control mode for the selected marker to **Delta** mode.

Key Path	Peak Search
Instrument S/W Revision	A.01.60 or later

Pk-Pk Search

Finds and displays the amplitude and frequency (or time, if in zero span) differences between the highest and lowest y-axis value.

Remote Command	:CALCulate:CDPower:MARKer [1] 2 3 4 5 6 7 8 9 10 11 12 :P TPeak
Dependencies/Couplings	This key is not available (key is grayed out) when Coupled Markers is on.
Example	CALC:CDP:MARK:PTP
Key Path	Peak Search
Mode	TD-SCDMA
Notes	Turns on the Marker Δ active function.
Instrument S/W Revision	A.01.60 or later

Min Search

Moves the selected marker to the minimum y-axis value on the current trace.

Remote Command	:CALCulate:CDPower:MARKer [1] 2 3 4 5 6 7 8 9 10 11 12 :M INimum
Example	CALC:CDP:MARK:MIN
Key Path	Peak Search

Mode	TD-SCDMA
Instrument S/W Revision	A.01.60 or later

Recall

Operation of this key is identical across several measurements. For details about this key, see [“Recall” on page 1179](#) in the "Common Measurement Functions".

Restart

Operation of this key is identical across several measurements. For details about this key, see [“Restart” on page 1201](#) in the "Common Measurement Functions".

Save

Operation of this key is identical across several measurements. For details about this key, see [“Save” on page 1203](#) in the "Common Measurement Functions".

Single

Operation of this key is identical across several measurements. For details about this key, see “[Single \(Single Measurement/Sweep\)](#)” on page 1229 in the "Common Measurement Functions".

Source

There is no source functionality supported in the Code Domain measurement.

Key Path	Front-panel key
Instrument S/W Revision	A.01.60 or later

SPAN X Scale

The SPAN X Scale key accesses the menu to set the desired horizontal scale and associated settings of window.

Code Domain EVM, Code Domain Mag Error, Code Domain Phase Error and Code Domain Symbol Power window have the same SPAN/X Scale menu. Code Domain Power and Code Domain Error window have the same menu. For all of the other windows this menu is empty.

Key Path	Front panel key
Instrument S/W Revision	A.01.60 or later

Ref Value

This key allows you to set the display reference. This key is only available in Code Domain EVM Window, Code Domain Mag Error Window, Code Domain Phase Error Window, Code Domain Symbol Power Window, Code Domain Power Window and Code Domain Error Window.

X Ref Value (I/Q Error View – Code Domain Mag Error Window)

This key sets the symbol reference value on the horizontal axis in the Code Domain Mag Error window.

Remote Command	:DISPlay:CDPower:VIEW3:WINDow[1]:TRACe:X[:SCALE]:RLEVel <real> :DISPlay:CDPower:VIEW3:WINDow[1]:TRACe:X[:SCALE]:RLEVel ?
Dependencies/Couplings	See Restriction and Notes
Example	DISP:CDP:VIEW3:WIND:TRAC:X:RLEV 0 DISP:CDP:VIEW3:WIND:TRAC:X:RLEV?
Key Path	Span X Scale
Mode	TD-SCDMA
Notes	If Auto Scale is set to On, this value is automatically determined by the measurement result. When you set this value manually, Auto Scale is automatically set to Off. VIEW3 : I/Q Error View WINDow[1]: Code Domain Mag Error Window on I/Q Error View
Preset	0
State Saved	Saved in instrument state.
Min	0
Max	1000

Code Domain Measurement
SPAN X Scale

Test MIN/MAX/DEF	Yes
Test UP/DOWN	1, 2, 5, 10
Instrument S/W Revision	A.01.60 or later

X Ref Value (I/Q Error View – Code Domain Phase Error Window)

This key sets the symbol reference value on the horizontal axis in the Code Domain Phase Error window.

Remote Command	:DISPlay:CDPower:VIEW3:WINDow2:TRACe:X[:SCALE]:RLEVel <real> :DISPlay:CDPower:VIEW3:WINDow2:TRACe:X[:SCALE]:RLEVel?
Dependencies/Couplings	See Restriction and Notes
Example	DISP:CDP:VIEW3:WIND2:TRAC:X:RLEV 0 DISP:CDP:VIEW3:WIND2:TRAC:X:RLEV?
Key Path	Span X Scale
Mode	TD-SCDMA
Notes	If Auto Scale is set to On, this value is automatically determined by the measurement result. When you set this value manually, Auto Scale is automatically set to Off. VIEW3 : I/Q Error View WINDow2: Code Domain Phase Error Window on I/Q Error View
Preset	0
State Saved	Saved in instrument state.
Min	0
Max	1000
Test MIN/MAX/DEF	Yes
Test UP/DOWN	1, 2, 5, 10
Instrument S/W Revision	A.01.60 or later

X Ref Value (I/Q Error View – Code Domain EVM Window)

This key sets the symbol reference value on the horizontal axis in the Code Domain EVM Window.

Remote Command	:DISPlay:CDPower:VIEW3:WINDow3:TRACe:X[:SCALE]:RLEVel <real> :DISPlay:CDPower:VIEW3:WINDow3:TRACe:X[:SCALE]:RLEVel?
Dependencies/Couplings	See Restriction and Notes

Example	DISP:CDP:VIEW3:WIND3:TRAC:X:RLEV 0 DISP:CDP:VIEW3:WIND3:TRAC:X:RLEV?
Key Path	Span X Scale
Mode	TD-SCDMA
Notes	If Auto Scale is set to On, this value is automatically determined by the measurement result. When you set this value manually, Auto Scale is automatically set to Off. VIEW3 : I/Q Error View WINDow3: Code Domain EVM Window on I/Q Error View
Preset	0
State Saved	Saved in instrument state.
Min	0
Max	1000
Test MIN/MAX/DEF	Yes
Test UP/DOWN	1, 2, 5, 10
Instrument S/W Revision	A.01.60 or later

X Ref Value (Code Domain Symbol Power Window)

This key sets the symbol reference value on the horizontal axis in the Code Domain Symbol Power Window.

Remote Command	:DISPlay:CDPower:VIEW4 5 : WINDow2 : TRACe:X [: SCALe] : RLEVel <real> :DISPlay:CDPower:VIEW4 5 : WINDow2 : TRACe:X [: SCALe] : RLEVel ?
Dependencies/Couplings	See Restriction and Notes
Example	DISP:CDP:VIEW4:WIND2:TRAC:X:RLEV 0 DISP:CDP:VIEW4:WIND2:TRAC:X:RLEV? DISP:CDP:VIEW5:WIND2:TRAC:X:RLEV 0 DISP:CDP:VIEW5:WIND2:TRAC:X:RLEV?
Key Path	Span X Scale
Mode	TD-SCDMA

Code Domain Measurement
SPAN X Scale

Notes	If Auto Scale is set to On, this value is automatically determined by the measurement result. When you set this value manually, Auto Scale is automatically set to Off. VIEW4 : Code Domain View VIEW5 : Demod Bits View WINDow2: Code Domain Symbol Power Window on Code Domain View or Demod Bits View
Preset	0
State Saved	Saved in instrument state.
Min	0
Max	1000
Test MIN/MAX/DEF	Yes
Test UP/DOWN	1, 2, 5, 10
Instrument S/W Revision	A.01.60 or later

X Ref Value (Code Domain Power Window)

This key sets the code reference value on the horizontal axis in the Code Domain Power window.

Remote Command	:DISPlay:CDPower:VIEW[1] 4 5:WINDow[1] :TRACe:X[:SCALE] :RLEVel <integer> :DISPlay:CDPower:VIEW[1] 4 5:WINDow[1] :TRACe:X[:SCALE] :RLEVel?
Example	DISP:CDP:VIEW:WIND:TRAC:X:RLEV 0 DISP:CDP:VIEW:WIND:TRAC:X:RLEV? DISP:CDP:VIEW4:WIND:TRAC:X:RLEV 0 DISP:CDP:VIEW4:WIND:TRAC:X:RLEV? DISP:CDP:VIEW5:WIND:TRAC:X:RLEV 0 DISP:CDP:VIEW5:WIND:TRAC:X:RLEV?
Key Path	Span X Scale
Mode	TD-SCDMA
Notes	VIEW[1] : CDP Graph and Metrics View VIEW4 : Code Domain View VIEW5 : Demod Bits View WINDow[1]: Code Domain Power Window on CDP Graph and Metrics View or Code Domain View, Demod Bits View
Preset	0

State Saved	Saved in instrument state.
Min	0
Max	16
Test MIN/MAX/DEF	Yes
Test UP/DOWN	5
Instrument S/W Revision	A.01.60 or later

X Ref Value (Code Domain Error Window)

This key sets the code reference value on the horizontal axis in the Code Domain Error window.

Remote Command	:DISPlay:CDPower:VIEW2:WINDow[1]:TRACe:X[:SCALe]:RLEVel <integer> :DISPlay:CDPower:VIEW2:WINDow[1]:TRACe:X[:SCALe]:RLEVel ?
Example	DISP:CDP:VIEW2:WIND:TRAC:X:RLEV 0.0 DISP:CDP:VIEW2:WIND:TRAC:X:RLEV?
Key Path	Span X Scale
Mode	TD-SCDMA
Notes	VIEW2 : CDE Graph and Metrics View WINDow[1]: Code Domain Error windows on CDE Graph and Metrics View
Preset	0
State Saved	Saved in instrument state.
Min	0
Max	16
Test MIN/MAX/DEF	Yes
Test UP/DOWN	5
Instrument S/W Revision	A.01.60 or later

Scale/Div

This key is for X Scale/Div control. This key is only available in Code Domain EVM Window, Code Domain Mag Error Window, Code Domain Phase Error Window, Code Domain Symbol Power Window, Code Domain Power Window and Code Domain Error Window.

X Scale/Div (I/Q Error View – Code Domain Mag Error Window)

This key sets the horizontal scale by changing a symbol value per division in the Code Domain Mag

Code Domain Measurement
SPAN X Scale

Error window.

Remote Command	:DISPlay:CDPower:VIEW3:WINDow[1]:TRACe:X[:SCALE]:PDIVis ion <real> :DISPlay:CDPower:VIEW3:WINDow[1]:TRACe:X[:SCALE]:PDIVis ion?
Dependencies/Couplings	See Restriction and Notes
Example	DISP:CDP:VIEW3:WIND:TRAC:X:PDIV 100.0 DISP:CDP:VIEW3:WIND:TRAC:X:PDIV?
Key Path	Span X Scale
Mode	TD-SCDMA
Notes	If Auto Scale is set to On, this value is automatically determined by the measurement result. When you set this value manually, Auto Scale is automatically set to Off. VIEW3: I/Q Error View WINDow[1]: Code Domain Mag Error Window on I/Q Error View
Preset	4.4
State Saved	Saved in instrument state.
Min	0.2
Max	1000.0
Test MIN/MAX/DEF	Yes
Test UP/DOWN	1, 2, 5, 10
Instrument S/W Revision	A.01.60 or later

X Scale/Div (I/Q Error View – Code Domain Phase Error Window)

This key sets the horizontal scale by changing a symbol value per division in the Code Domain Phase Error window.

Remote Command	:DISPlay:CDPower:VIEW3:WINDow2:TRACe:X[:SCALE]:PDIVisio n <real> :DISPlay:CDPower:VIEW3:WINDow2:TRACe:X[:SCALE]:PDIVisio n?
Dependencies/Couplings	See Restriction and Notes
Example	DISP:CDP:VIEW3:WIND2:TRAC:X:PDIV 100.0 DISP:CDP:VIEW3:WIND2:TRAC:X:PDIV?
Key Path	Span X Scale
Mode	TD-SCDMA

Notes	If Auto Scale is set to On, this value is automatically determined by the measurement result. When you set this value manually, Auto Scale is automatically set to Off. VIEW3: I/Q Error View WINDow2: Code Domain Phase Error Window on I/Q Error View
Preset	4.4
State Saved	Saved in instrument state.
Min	0.2
Max	1000.0
Test MIN/MAX/DEF	Yes
Test UP/DOWN	1, 2, 5, 10
Instrument S/W Revision	A.01.60 or later

X Scale/Div (I/Q Error View – Code Domain EVM Window)

This key sets the horizontal scale by changing a symbol value per division in Code Domain EVM window.

Remote Command	:DISPlay:CDPower:VIEW3:WINDow3:TRACe:X[:SCALE]:PDIVision <real> :DISPlay:CDPower:VIEW3:WINDow3:TRACe:X[:SCALE]:PDIVision?
Dependencies/Couplings	See Restriction and Notes
Example	DISP:CDP:VIEW3:WIND3:TRAC:X:PDIV 100.0 DISP:CDP:VIEW3:WIND3:TRAC:X:PDIV?
Key Path	Span X Scale
Mode	TD-SCDMA
Notes	If Auto Scale is set to On, this value is automatically determined by the measurement result. When you set this value manually, Auto Scale is automatically set to Off. VIEW3: I/Q Error View WINDow3: Code Domain EVM Window on I/Q Error View
Preset	4.4
State Saved	Saved in instrument state.
Min	0.2
Max	1000.0
Test MIN/MAX/DEF	Yes

Code Domain Measurement
SPAN X Scale

Test UP/DOWN	1, 2, 5, 10
Instrument S/W Revision	A.01.60 or later

X Scale/Div (Code Domain Symbol Power Window)

This key sets the horizontal scale by changing a symbol value per division in Code Domain Symbol Power window.

Remote Command	:DISPlay:CDPower:VIEW4 5:WINDow2:TRACe:X[:SCALE]:PDIVis ion <real> :DISPlay:CDPower:VIEW4 5:WINDow2:TRACe:X[:SCALE]:PDIVis ion?
Dependencies/Couplings	See Restriction and Notes
Example	DISP:CDP:VIEW4:WIND2:TRAC:X:PDIV 100.0 DISP:CDP:VIEW4:WIND2:TRAC:X:PDIV? DISP:CDP:VIEW5:WIND2:TRAC:X:PDIV 100.0 DISP:CDP:VIEW5:WIND2:TRAC:X:PDIV?
Key Path	Span X Scale
Mode	TD-SCDMA
Notes	If Auto Scale is set to On, this value is automatically determined by the measurement result. When you set this value manually, Auto Scale is automatically set to Off. VIEW4: Code Domain View VIEW5: Demod Bits View WINDow2: Code Domain Symbol Power Window on Code Domain View or Demod Bits View
Preset	4.4
State Saved	Saved in instrument state.
Min	0.2
Max	1000.0
Test MIN/MAX/DEF	Yes
Test UP/DOWN	1, 2, 5, 10
Instrument S/W Revision	A.01.60 or later

X Scale/Div (Code Domain Power Window)

This key sets the horizontal scale by changing a code value per division in the Code Domain Power

window.

Remote Command	:DISPlay:CDPower:VIEW[1] 4 5:WINDow[1]:TRACe:X[:SCALe]:PDIVision <integer> :DISPlay:CDPower:VIEW[1] 4 5:WINDow[1]:TRACe:X[:SCALe]:PDIVision?
Example	DISP:CDP:VIEW:WIND:TRAC:X:PDIV 16 DISP:CDP:VIEW:WIND:TRAC:X:PDIV? DISP:CDP:VIEW4:WIND:TRAC:X:PDIV 16 DISP:CDP:VIEW4:WIND:TRAC:X:PDIV? DISP:CDP:VIEW5:WIND:TRAC:X:PDIV 16 DISP:CDP:VIEW5:WIND:TRAC:X:PDIV?
Key Path	Span X Scale
Mode	TD-SCDMA
Notes	VIEW[1]: CDP Graph and Metrics View VIEW4: Code Domain View VIEW5: Demod Bits View WINDow[1]: Code Domain Power Window on CDP Graph and Metrics View or Code Domain View, Demod Bits View
Preset	16
State Saved	Saved in instrument state.
Min	1
Max	16
Test MIN/MAX/DEF	Yes
Test UP/DOWN	5
Instrument S/W Revision	A.01.60 or later

X Scale/Div (Code Domain Error Window)

This key sets the horizontal scale by changing a code value per division in the Code Domain Error window.

Remote Command	:DISPlay:CDPower:VIEW2:WINDow[1]:TRACe:X[:SCALe]:PDIVision <integer> :DISPlay:CDPower:VIEW2:WINDow[1]:TRACe:X[:SCALe]:PDIVision?
Example	DISP:CDP:VIEW2:WIND:TRAC:X:PDIV 16 DISP:CDP:VIEW2:WIND:TRAC:X:PDIV?

Code Domain Measurement
SPAN X Scale

Key Path	Span X Scale
Mode	TD-SCDMA
Notes	VIEW2: CDE Graph and Metrics View WINDow[1]: Code Domain Error windows on CDE Graph and Metrics View
Preset	16
State Saved	Saved in instrument state.
Min	1
Max	16
Test MIN/MAX/DEF	Yes
Test UP/DOWN	5
Instrument S/W Revision	A.01.60 or later

Ref Position

This key allows you to set the display reference position to Left, Ctr (center), or Right. This key is only available in Code Domain EVM Window, Code Domain Mag Error Window, Code Domain Phase Error Window, Code Domain Symbol Power Window, Code Domain Power Window and Code Domain Error Window.

X Ref Position (I/Q Error View – Code Domain Mag Error Window)

This key sets the X axis reference position in the Code Domain Mag Error window.

Remote Command	:DISPlay:CDPower:VIEW3:WINDow[1]:TRACe:X[:SCALe]:RPOSit ion LEFT CENTer RIGHT :DISPlay:CDPower:VIEW3:WINDow[1]:TRACe:X[:SCALe]:RPOSit ion?
Example	DISP:CDP:VIEW3:WIND:TRAC:X:RPOS LEFT DISP:CDP:VIEW3:WIND:TRAC:X:RPOS?
Key Path	Span X Scale
Mode	TD-SCDMA
Notes	VIEW3 : I/Q Error View WINDow[1]: Code Domain Mag Error Window on I/Q Error View
Preset	LEFT
State Saved	Saved in instrument state.
Range	Left Ctr Right
Instrument S/W Revision	A.01.60 or later

X Ref Position (I/Q Error View – Code Domain Phase Error Window)

This key sets the X axis reference position in the Code Domain Phase Error window.

Remote Command	:DISPlay:CDPower:VIEW3:WINDow2:TRACe:X[:SCALe]:RPOSitio n LEFT CENTer RIGHT :DISPlay:CDPower:VIEW3:WINDow2:TRACe:X[:SCALe]:RPOSitio n?
Example	DISP:CDP:VIEW3:WIND2:TRAC:X:RPOS LEFT DISP:CDP:VIEW3:WIND2:TRAC:X:RPOS?
Key Path	Span X Scale
Mode	TD-SCDMA
Notes	VIEW3 : I/Q Error View WINDow2: Code Domain Phase Error Window on I/Q Error View
Preset	LEFT
State Saved	Saved in instrument state.
Range	Left Ctr Right
Instrument S/W Revision	A.01.60 or later

X Ref Position (I/Q Error View – Code Domain EVM Window)

This key sets the X axis reference position in the Code Domain EVM window.

Remote Command	:DISPlay:CDPower:VIEW3:WINDow3:TRACe:X[:SCALe]:RPOSitio n LEFT CENTer RIGHT :DISPlay:CDPower:VIEW3:WINDow3:TRACe:X[:SCALe]:RPOSitio n?
Example	DISP:CDP:VIEW3:WIND3:TRAC:X:RPOS LEFT DISP:CDP:VIEW3:WIND3:TRAC:X:RPOS?
Key Path	Span X Scale
Mode	TD-SCDMA
Notes	VIEW3 : I/Q Error View WINDow3: Code Domain EVM Window on I/Q Error View
Preset	LEFT
State Saved	Saved in instrument state.
Range	Left Ctr Right
Instrument S/W Revision	A.01.60 or later

X Ref Position (Code Domain Symbol Power Window)

This key sets the X axis reference position in the Code Domain Symbol Power window.

Remote Command	:DISPlay:CDPower:VIEW4 5:WINDow2:TRACe:X[:SCALE]:RPOSit ion LEFT CENTer RIGHT :DISPlay:CDPower:VIEW4 5:WINDow2:TRACe:X[:SCALE]:RPOSit ion?
Example	DISP:CDP:VIEW4:WIND2:TRAC:X:RPOS LEFT DISP:CDP:VIEW4:WIND2:TRAC:X:RPOS? DISP:CDP:VIEW5:WIND2:TRAC:X:RPOS LEFT DISP:CDP:VIEW5:WIND2:TRAC:X:RPOS?
Key Path	Span X Scale
Mode	TD-SCDMA
Notes	VIEW4 : Code Domain View VIEW5 : Demod Bits View WINDow2: Code Domain Symbol Power Window on Code Domain View or Demod Bits View
Preset	LEFT
State Saved	Saved in instrument state.
Range	Left Ctr Right
Instrument S/W Revision	A.01.60 or later

X Ref Position (Code Domain Power Window)

This key sets the X axis reference position in the Code Domain Power window.

Remote Command	:DISPlay:CDPower:VIEW[1] 4 5:WINDow[1]:TRACe:X[:SCALE]: RPOSit ion LEFT CENTer RIGHT :DISPlay:CDPower:VIEW[1] 4 5:WINDow[1]:TRACe:X[:SCALE]: RPOSit ion?
Example	DISP:CDP:VIEW:WIND:TRAC:X:RPOS LEFT DISP:CDP:VIEW:WIND:TRAC:X:RPOS? DISP:CDP:VIEW4:WIND:TRAC:X:RPOS LEFT DISP:CDP:VIEW4:WIND:TRAC:X:RPOS? DISP:CDP:VIEW5:WIND:TRAC:X:RPOS LEFT DISP:CDP:VIEW5:WIND:TRAC:X:RPOS?
Key Path	Span X Scale
Mode	TD-SCDMA

Notes	VIEW[1] : CDP Graph and Metrics View VIEW4 : Code Domain View VIEW5 : Demod Bits View WINDow[1]: Code Domain Power Window on CDP Graph and Metrics View or Code Domain View, Demod Bits View
Preset	LEFT
State Saved	Saved in instrument state.
Range	Left Ctr Right
Instrument S/W Revision	A.01.60 or later

X Ref Position (Code Domain Error Window)

This key sets the X axis reference position in the Code Domain Error window.

Remote Command	:DISPlay:CDPower:VIEW2:WINDow[1]:TRACe:X[:SCALe]:RPOSit ion LEFT CENTer RIGHT :DISPlay:CDPower:VIEW2:WINDow[1]:TRACe:X[:SCALe]:RPOSit ion?
Example	DISP:CDP:VIEW2:WIND:TRAC:X:RPOS LEFT DISP:CDP:VIEW2:WIND:TRAC:X:RPOS?
Key Path	Span X Scale
Mode	TD-SCDMA
Notes	VIEW2 : CDE Graph and Metrics View WINDow[1]: Code Domain Error windows on CDE Graph and Metrics View
Preset	LEFT
State Saved	Saved in instrument state.
Range	Left Ctr Right
Instrument S/W Revision	A.01.60 or later

Auto Scale

This key allows you to toggle the scale coupling function between On and Off. This key is only available in Code Domain EVM Window, Code Domain Mag Error Window, Code Domain Phase Error Window and Code Domain Symbol Power Window.

X Auto Scale (I/Q Error View – Code Domain Mag Error Window)

When Auto Scale is On, it will result in automatically displaying the scale per division and reference

Code Domain Measurement
SPAN X Scale

value results in the Code Domain Mag Error window.

Remote Command	:DISPlay:CDPower:VIEW3:WINDow[1]:TRACe:X[:SCALe]:COUPle 0 1 OFF ON :DISPlay:CDPower:VIEW3:WINDow[1]:TRACe:X[:SCALe]:COUPle ?
Dependencies/Couplings	See Restriction and Notes
Example	DISP:CDP:VIEW3:WIND:TRAC:X:COUP ON DISP:CDP:VIEW3:WIND:TRAC:X:COUP?
Key Path	Span X Scale
Mode	TD-SCDMA
Notes	When this parameter is set to On, it will activate the scale coupling function that automatically determines scale per division and reference values based on the measurement results. When you set a value to either Scale/Div or Ref Value manually, Auto Scale is automatically set to Off. VIEW3 : I/Q Error View WINDow[1]: Code Domain Mag Error Window on I/Q Error View
Preset	ON
State Saved	Saved in instrument state.
Range	On Off
Instrument S/W Revision	A.01.60 or later

X Auto Scale (I/Q Error View – Code Domain Phase Error Window)

When Auto Scale is On, it will result in automatically displaying the scale per division and reference value results in the Code Domain Phase Error window.

Remote Command	:DISPlay:CDPower:VIEW3:WINDow2:TRACe:X[:SCALe]:COUPle 0 1 OFF ON :DISPlay:CDPower:VIEW3:WINDow2:TRACe:X[:SCALe]:COUPle?
Dependencies/Couplings	See Restriction and Notes
Example	DISP:CDP:VIEW3:WIND2:TRAC:X:COUP ON DISP:CDP:VIEW3:WIND2:TRAC:X:COUP?
Key Path	Span X Scale
Mode	TD-SCDMA

Notes	When this parameter is set to On, it will activate the scale coupling function that automatically determines scale per division and reference values based on the measurement results. When you set a value to either Scale/Div or Ref Value manually, Auto Scale is automatically set to Off. VIEW3 : I/Q Error View WINDow2: Code Domain Phase Error Window on I/Q Error View
Preset	ON
State Saved	Saved in instrument state.
Range	On Off
Instrument S/W Revision	A.01.60 or later

X Auto Scale (I/Q Error View – Code Domain EVM Window)

When Auto Scale is On, it will result in automatically displaying the scale per division and reference value results in the Code Domain EVM window.

Remote Command	:DISPlay:CDPower:VIEW3:WINDow3:TRACe:X[:SCALE]:COUPlE 0 1 OFF ON :DISPlay:CDPower:VIEW3:WINDow3:TRACe:X[:SCALE]:COUPlE?
Dependencies/Couplings	See Restriction and Notes
Example	DISP:CDP:VIEW3:WIND3:TRAC:X:COUP ON DISP:CDP:VIEW3:WIND3:TRAC:X:COUP?
Key Path	Span X Scale
Mode	TD-SCDMA
Notes	When this parameter is set to On, it will activate the scale coupling function that automatically determines scale per division and reference values based on the measurement results. When you set a value to either Scale/Div or Ref Value manually, Auto Scale is automatically set to Off. VIEW3 : I/Q Error View WINDow3: Code Domain EVM Window on I/Q Error View
Preset	ON
State Saved	Saved in instrument state.
Range	On Off
Instrument S/W Revision	A.01.60 or later

X Auto Scale (Code Domain Symbol Power Window)

When Auto Scale is On, it will result in automatically displaying the scale per division and reference

Code Domain Measurement
SPAN X Scale

value results in the Code Domain Symbol Power window.

Remote Command	:DISPlay:CDPower:VIEW4 5:WINDow2:TRACe:X[:SCALe]:COUPle 0 1 OFF ON :DISPlay:CDPower:VIEW4 5:WINDow2:TRACe:X[:SCALe]:COUPle ?
Dependencies/Couplings	See Restriction and Notes
Example	DISP:CDP:VIEW4:WIND2:TRAC:X:COUP ON DISP:CDP:VIEW4:WIND2:TRAC:X:COUP? DISP:CDP:VIEW5:WIND2:TRAC:X:COUP ON DISP:CDP:VIEW5:WIND2:TRAC:X:COUP?
Key Path	Span X Scale
Mode	TD-SCDMA
Notes	When this parameter is set to On, it will activate the scale coupling function that automatically determines scale per division and reference values based on the measurement results. When you set a value to either Scale/Div or Ref Value manually, Auto Scale is automatically set to Off. VIEW4 : Code Domain View VIEW5 : Demod Bits View WINDow2: Code Domain Symbol Power Window on Code Domain View or Demod Bits View
Preset	ON
State Saved	Saved in instrument state.
Range	On Off
Instrument S/W Revision	A.01.60 or later

Sweep/Control

Operation of this key is identical across several measurements. For details about this key, see [“Sweep / Control” on page 1235](#).

NOTE Gate function is not supported in the Code Domain measurement.

Key Path	Front panel key
Instrument S/W Revision	A.01.60 or later

Abort (Remote Command Only)

See [“Abort \(Remote Command Only\)” on page 1235](#) in the section "Common Measurement Functions" for more information.

Pause and Resume

See [“Pause/Resume” on page 1236](#) in the section "Common Measurement Functions" for more information.

Trace/Detector

There is no trace/detector functionality supported in this measurement.

Key Path	Front-panel key
Instrument S/W Revision	A.01.60 or later

Trigger

Selects the trigger source and trigger setup functionality.

Key Path	Front panel key
Instrument S/W Revision	A.01.60 or later

Trigger Source

Selects a trigger source for current measurement.

See also:

[RF Trigger Source](#)

[I/Q Trigger Source](#)

NOTE Trigger Source setup parameters are valid for the current measurement.

Remote Command	:TRIGger:CDPower[:SEQuence]:SOURce EXTErnal[1] EXTErnal2 IMMediate RFBurst VIDeo IQMag IDEMod QDEMod IINPut QINPut AIQMag :TRIGger:CDPower[:SEQuence]:SOURce?
Example	TRIG:CDP:SOUR RFB TRIG:CDP:SOUR?
Key Path	Trigger
Mode	TD-SCDMA
Notes	<ol style="list-style-type: none"> 1. 2. Video and RF Burst are available only when in RF input and those selection menu keys are blank when in I/Q Input. 3. Baseband I/Q key is available only when in I/Q input, otherwise blank. IQMag, IDEMod, QDEMod, IINPut, QINPut and AIQMag are valid only when in I/Q input. 4. You must be in the TD-SCDMA mode to use this command. Use INSTrument:SElect to set the mode.
Preset	Varies with selected input (see RF Trigger Source and I/Q Trigger Source)
State Saved	Saved in instrument state.
Range	Free Run (Immediate) Video (IF Envlp) External 1 External 2 RF Burst (Wideband) I/Q Mag I (Demodulated) Q (Demodulated) Input I Input Q Auxiliary Channel I/Q Mag

Code Domain Measurement Trigger

Instrument S/W Revision A.01.60 or later

RF Trigger Source

Specifies the Trigger Source for RF Input signals.

Remote Command	:TRIGger:CDPower[:SEquence]:RF:SOURce IMMediate EXTErnal[1] EXTErnal2 RFBurst VIDeo :TRIGger:CDPower[:SEquence]:RF:SOURce?
Example	TRIG:CDP:RF:SOUR RFB TRIG:CDP:RF:SOUR?
Key Path	Trigger
Mode	TD-SCDMA
Notes	1. You must be in the TD-SCDMA mode to use this command. Use INSTRUMENT:SElect to set the mode.
Preset	IMMediate
State Saved	Saved in instrument state.
Range	Free Run (Immediate) Video (IF Envlp) External 1 External 2 RF Burst (Wideband)
Instrument S/W Revision	A.01.60 or later

I/Q Trigger Source

Specifies the Trigger Source for I/Q Input signals.

Remote Command	:TRIGger:CDPower[:SEquence]:IQ:SOURce IMMediate EXTErnal[1] EXTErnal2 IQMag IDEMod QDEMod IIN Put QINPut AIQMag :TRIGger:CDPower[:SEquence]:IQ:SOURce?
Example	TRIG:CDP:SOUR IQMag TRIG:CDP:SOUR?
Key Path	Trigger
Mode	TD-SCDMA
Notes	You must be in the TD-SCDMA mode to use this command. Use INSTRUMENT:SElect to set the mode.
Preset	IMMediate
State Saved	Saved in instrument state.
Range	Free Run (Immediate) External 1 External 2 I/Q Mag I (Demodulated) Q (Demodulated) Input I Input Q Auxiliary Channel I/Q Mag

Instrument S/W Revision A.01.60 or later

Auto Trig

See “[Auto Trig](#)” on page 1304 in the "Common Measurement Functions" for more information.

Trig Holdoff

See “[Trig Holdoff](#)” on page 1304 in the "Common Measurement Functions" for more information.

View/Display

The View/Display key opens up the View menu for the current measurement. The views that are available are specific to the current measurement selected under the **Meas** key.

For more information, see [“View/Display” on page 1307](#).

Key Path	Front panel key
Instrument S/W Revision	A.01.60 or later

Display

Refer to View/Display, [“Display” on page 1307](#) in the "Common Measurement Functions" for more information.

View Selection by Name

Allows you to select the desired measurement view from the following selections:

- CDP Graph & Metrics – provides a combination view of the code domain power graph and the summary data.
- CDE Graph & Metrics – provides a combination view of the code domain power graph and the code domain error.
- I/Q Error – provides a combination view of magnitude error, phase error, symbol EVM and the summary data.
- Code Domain – provides a combination view of the code domain power, symbol power, I/Q symbol polar vector and the summary data.
- Demod Bits – provides a combination view of the graphs for the code domain power and symbol power, and the I/Q demodulated bit stream data for the symbol power slots selected by the measurement interval and measurement offset.
- Result Metrics – provides a view of the measurement summary data.

Remote Command	:DISPlay:CDPower:VIEW[:SElect] CDPGraph CDEGraph IQERror CDOMain DBITs RESMetrics :DISPlay:CDPower:VIEW?
----------------	--

Example	:DISP:CDP:VIEW CDPG :DISP:CDP:VIEW?
---------	--

Key Path	View/Display
Mode	TD-SCDMA
Preset	CDPGraph
State Saved	Saved in instrument state.

Range CDP Graph & Metrics | CDE Graph & Metrics | I/Q Error | Code Domain | Demod Bits| Result Metrics

Instrument S/W Revision A.01.60 or later

CDP Graph & Metrics

- Selects a combination view of the code domain power graph and the summary data.
-

Key Path **View/Display**

Example :DISPlay:CDPower:VIEW CDPGraph
:DISPlay:CDP:VIEW?

Instrument S/W Revision A.01.60 or later

CDE Graph & Metrics

- Selects a combination view of the code domain power graph and the summary data.
-

Key Path **View/Display**

Example :DISPlay:CDPower:VIEW CDEGraph
:DISPlay:CDP:VIEW?

Instrument S/W Revision A.01.60 or later

I/Q Error (quad view)

- Provides a combination view of magnitude error, phase error, symbol EVM and the summary data.
-

Key Path **View/Display**

Example :DISPlay:CDPower:VIEW IQERror
:DISPlay:CDPower:VIEW?

Instrument S/W Revision A.01.60 or later

Code Domain

- Provides a combination view of the code domain power, symbol power, I/Q symbol polar vector and the summary data.
-

Key Path **View/Display**

Code Domain Measurement View/Display

Example :DISPlay:CDPower:VIEW CDOMain
:DISPlay:CDPower:VIEW?

Instrument S/W Revision A.01.60 or later

Demod Bits

- Provides a combination view of the graphs for the code domain power and symbol power, and the I/Q demodulated bit stream data for the symbol power slots selected by the measurement interval and measurement offset.

•

Key Path **View/Display**

Example :DISPlay:CDPower:VIEW DBITs
:DISPlay:CDPower:VIEW?

Instrument S/W Revision A.01.60 or later

Result Metrics

- Provides a view of the measurement summary data..

•

Key Path **View/Display**

Example :DISPlay:CDPower:VIEW RESMetrics
:DISPlay:CDPower:VIEW?

Instrument S/W Revision A.01.60 or later

View Selection by Number (Remote Command only)

Allows you to select the desired measurement view from the following selections by Remote Commands:

- CDP Graph & Metrics – provides a combination view of the code domain power graph and the summary data.
- CDE Graph & Metrics – provides a combination view of the code domain power graph and the code domain error.
- I/Q Error – provides a combination view of magnitude error, phase error, symbol EVM and the summary data.
- Code Domain – provides a combination view of the code domain power, symbol power, I/Q symbol polar vector and the summary data.
- Demod Bits – provides a combination view of the graphs for the code domain power and symbol power, and the I/Q demodulated bit stream data for the symbol power slots selected by the measurement interval and measurement offset.

- Result Metrics – provides a view of the measurement summary data.

Remote Command	:DISPlay:CDPower:VIEW:NSElect <integer> :DISPlay:CDPower:VIEW:NSElect?
Example	DISP:CDP:VIEW:NSEL 1 DISP:CDP:VIEW:NSEL?
Mode	TD-SCDMA
Notes	Meaning of the numeric values: 1: CDP Graph & Metrics View 2: CDE Graph & Metrics View 3: IQ Error View 4: Code Domain View 5: Demod Bits View 6: Result Metrics View
Preset	1
State Saved	Saved in instrument state.
Min	1
Max	6
Test MIN/MAX/DEF	No
Instrument S/W Revision	A.01.60 or later

View Settings

Modifies the display settings for current view and window.

Key Path	Front Panel
Instrument S/W Revision	A.01.60 or later

View Settings Menu under I/Q Symbol Polar Vector Windows

When you select Code Domain view and press Next Window key to select Chan I/Q Measured Polar Vector window, you can modify the display settings for the polar graph.

Key Path	Front Panel
Instrument S/W Revision	A.01.60 or later

I/Q Polar Vect/Constln Selects the format of the Polar Graph display. You can select one of the following formats:

- Vector & Constellation

Code Domain Measurement
View/Display

- Vector
- Constellation..
-

Remote Command	:DISPlay:CDPower:IQPTtype VCONstln VECTor CONStln :DISPlay:CDPower:IQPTtype?
Example	:DISP:CDP:IQPT VCON :DISP:CDP:IQPT?
Key Path	View/Display, Code Domain
Mode	TD-SCDMA
Notes	<ul style="list-style-type: none"> • Three polar display types: • Vec&Constln: Sets the view to display both the vector and constellation diagrams • Vector: Sets the view to display an I/Q polar vector diagram • Constellation: Sets the view to display the constellation diagram
Preset	VCONstln
State Saved	Saved in instrument state.
Range	Vec & Constln Vector Constellation
Test MIN/MAX/DEF	No
Instrument S/W Revision	A.01.60 or later

Vector & Constellation Sets the view to display both the vector and constellation diagrams.

Key Path	View/Display, Code Domain, I/Q Polar Vec/Constl
Example	:DISP:CDP:IQPT VCON :DISP:CDP:IQPT?
Instrument S/W Revision	A.01.60 or later

Vector Sets the view to display an I/Q polar vector diagram.

Key Path	View/Display, Code Domain, I/Q Polar Vec/Constl
Example	:DISPlay:CDP:IQPTtype VECTor :DISPlay:CDP:IQPTtype?
Instrument S/W Revision	A.01.60 or later

Constellation Sets the view to display the constellation diagram.

Key Path	View/Display, Code Domain, I/Q Polar Vec/Constl
Example	:DISPlay:CDP:IQPTType CONSTln :DISPlay:CDP:IQPTType?
Instrument S/W Revision	A.01.60 or later

I/Q Points Specifies the total number of I/Q points displayed during each measurement interval in the I/Q Symbol Polar Vector Graph.

Remote Command	:DISPlay:CDPower:IQPoints <integer> :DISPlay:CDPower:IQPoints?
Dependencies/Couplings	See Restriction and Notes.
Example	:DISP:CDP:IQP 80 :DISP:CDP:IQP?
Key Path	View/Display, Code Domain, I/Q Points
Mode	TD-SCDMA
Notes	The max I/Q points should be the symbol number in the specified code channel (equals to 704/spread code length). If the I/Q Points defined is larger than the symbol in the code channel, the I/Q Points will be clipped to its max possible number.
Preset	44
State Saved	Saved in instrument state.
Min	1
Max	1000
Test MIN/MAX/DEF	Yes
Test UP/DOWN	10
Instrument S/W Revision	A.01.60 or later

I/Q Points Offset Specifies an offset from the first I/Q point in the I/Q Polar diagrams. If you choose to display only a subset of the I/Q points, this subset of displayed points is offset from the first I/Q point.

Remote Command	:DISPlay:CDPower:IQPoints:OFFSet <integer> :DISPlay:CDPower:IQPoints:OFFSet?
Dependencies/Couplings	See Restriction and Notes.
Example	:DISP:CDP:IQP:OFFS 14 :DISP:CDP:IQP:OFFS?

Code Domain Measurement
View/Display

Key Path	View/Display, Code Domain, I/Q Points Offset
Mode	TD-SCDMA
Notes	The I/Q points Offset plus I/Q points should be less than the symbol number in the code channel(equals to 704/spread code length). If the I/Q Points Offset defined plus I/Q points is larger or equal than the symbols in the code channel, the I/Q Points Offset will be clipped to its max possible number.
Preset	0
State Saved	Saved in instrument state.
Min	0
Max	1000
Test MIN/MAX/DEF	Yes
Test UP/DOWN	10
Instrument S/W Revision	A.01.60 or later

I/Q Rotation Specifies whether or not the 45 degrees rotation is applied to the I/Q constellation.

Remote Command	:DISPlay:CDPower:ROtation OFF ON 0 1 :DISPlay:CDPower:ROtation?
Example	:DISP:CDP:ROT ON :DISP:CDP:ROT?
Key Path	View/Display, Code Domain, I/Q Rotation
Mode	TD-SCDMA
Preset	OFF
State Saved	Saved in instrument state.
Range	On Off
Test MIN/MAX/DEF	No
Instrument S/W Revision	A.01.60 or later

Interpolation Specifies whether the input I/Q data should be interpolated.

Remote Command	:DISPlay:CDPower:INTerpolate OFF ON 0 1 :DISPlay:CDPower:INTerpolate?
Example	:DISP:CDP:INT ON :DISP:CDP:INT?
Key Path	View/Display, Code Domain, Interpolation
Mode	TD-SCDMA

Preset	OFF
State Saved	Saved in instrument state.
Range	On Off
Test MIN/MAX/DEF	No
Instrument S/W Revision	A.01.60 or later

Full Vector (background) When Full Vector is off, the I/Q data is displayed from (I/Q Offset + 1), with length I/Q Points, in the selected timeslot and sub-frame. The points before (I/Q Offset + 1) will not be displayed.

When Full Vector is on, the trace will show all the I/Q vector in the selected timeslot and sub-frame, the hidden portion (the points before the I/Q offset) is displayed in gray.

Note:

For filter settling reasons, 4 chips at the start and end of the timeslot are ignored, resulting in data results that are 8 chips shorter than the full traffic timeslot length (not including the Guard Period).

Remote Command	:DISPlay:CDPower:FVEctor[:STATe] OFF ON 0 1 :DISPlay:CDPower:FVEctor[:STATe]?
Example	:DISP:CDP:FVEC ON :DISP:CDP:FVEC?
Key Path	View/Display, Code Domain, Full Vector
Mode	TD-SCDMA
Preset	OFF
State Saved	Saved in instrument state.
Range	On Off
Test MIN/MAX/DEF	No
Instrument S/W Revision	A.01.60 or later

View Settings Menu under Demod Bits Window

When you select Demod Bits view and press Next Window key to select Demod Bits Result window, you can modify the demodulated bits format for the demodulated bits results metric window, and control the display area by some scroll buttons.

Key Path	Front Panel
Instrument S/W Revision	A.01.60 or later

Demod Bit Format Allows you to select the show format of the demod bits.

Remote Command	:DISPlay:CDPower:DBITs:FORMat BINary HEX :DISPlay:CDPower:DBITs:FORMat?
Example	:DISP:CDP:DBIT:FORM HEX :DISP:CDP:DBIT:FORM?
Key Path	View/Display, Demod Bits, Demod Bit Format
Mode	TD-SCDMA
Preset	BINary
State Saved	Saved in instrument state.
Range	Binary Hex
Test MIN/MAX/DEF	No
Instrument S/W Revision	A.01.60 or later

View Settings Menu under Code Domain Power Window and Code Domain Error Window

When you select CDP Graph Metrics view or CDE Graph Metrics view, and press Next Window key to select the Graph window, you can modify the display settings for code domain graph.

Key Path	Front Panel
Instrument S/W Revision	A.01.60 or later

Composite Specifies whether the composite CDP/CDE is displayed. If composite is on, it displays CDP/CDE of all active channels on its own spread code length in red color, and inactive channels in yellow color. Otherwise, it displays CDP/CDE of all the channels on the spread code length specified by the second key under this menu in yellow color.

Remote Command	:DISPlay:CDPower:COMPOSITE OFF ON 0 1 :DISPlay:CDPower:COMPOSITE?
Dependencies/Couplings	If composite is on, the spread code length key followed it will be grayed out.
Example	:DISP:CDP:COMP ON :DISP:CDP:COMP?
Key Path	View/Display, CDP Graph & Metics, Composite View/Display, CDE Graph & Metics, Composite View/Display, Code Domain, Composite View/Display, Demod Bits, Composite
Mode	TD-SCDMA
Preset	ON

State Saved	Saved in instrument state.
Range	On Off
Test MIN/MAX/DEF	No
Instrument S/W Revision	A.01.60 or later

Spread Code Length Selects the active Spread Code Length for the CDP/CDE trace data. This parameter has no other effect except for the display of the CDP and CDE trace when composite is off. So if Composite is set to On, the Spread Code Length key will be grayed out.

Remote Command	:DISPlay:CDPower:SCLength <integer> :DISPlay:CDPower:SCLength?
Dependencies/Couplings	Only 1, 2, 4, 8, 16 are valid and any number will be clipped to the nearest valid number.
Example	:DISP:CDP:SCL 1 :DISP:CDP:SCL?
Key Path	View/Display, CDP Graph & Metics, Composite View/Display, CDE Graph & Metics, Composite View/Display, Code Domain, Composite View/Display, Demod Bits, Composite
Mode	TD-SCDMA
Preset	16
State Saved	Saved in instrument state.
Min	1
Max	16
Test MIN/MAX/DEF	Yes
Test UP/DOWN	1, 2, 4, 8
Instrument S/W Revision	A.01.60 or later

View Settings Menu under Code Domain Power Summary Window

When you select CDP Graph Metrics view or CDE Graph Metrics view, and press Next Window key to select Metrics window, you can control the code domain power summary metric window's display area by some scroll buttons.

Key Path	Front Panel
Instrument S/W Revision	A.01.60 or later

Scroll

If the active window is Code Domain Power Summary window in the Code Domain Power View, Code Domain Error View or Demod Bits window in the Demod Bits View, the View/Display key accesses the menu that enables the following controls to read the active channel list:

Prev Page - Returns one page back to the previous page of measurement results.

Next Page - Moves one page forward to the next page of measurement results.

Scroll Up - Moves one line upward from the current page of measurement results each time the key is pressed.

Scroll Down - Moves one line downward from the current page of measurement results each time the key is pressed.

First Page - Moves from the current page to the first page of measurement results.

Last Page - Moves from the current page to the last page of measurement results.

Key Path	View/Display, CDP Graph & Metics, Composite (Summary window selected)
	View/Display, CDE Graph & Metics, Composite (Summary window selected)
	View/Display, Code Domain (Summary window selected)
	View/Display, Demod Bits
Instrument S/W Revision	A.01.60 or later

Prev Page Moves one page back to the previous page of the measurement results.

Key Path	View/Display, CDP Graph & Metics, Composite (Summary window selected)
	View/Display, CDE Graph & Metics, Composite (Summary window selected)
	View/Display, Code Domain (Summary window selected)
	View/Display, Demod Bits
Notes	No SCPI
Instrument S/W Revision	A.01.60 or later

Next Page Moves one page forward to the previous page of the measurement results.

Key Path	View/Display, CDP Graph & Metics, Composite (Summary window selected) View/Display, CDE Graph & Metics, Composite (Summary window selected) View/Display, Code Domain (Summary window selected) View/Display, Demod Bits
Notes	No SCPI
Instrument S/W Revision	A.01.60 or later

Scroll Down Moves one line downward from the current page of the measurement results by each press.

Key Path	View/Display, CDP Graph & Metics, Composite (Summary window selected) View/Display, CDE Graph & Metics, Composite (Summary window selected) View/Display, Code Domain (Summary window selected) View/Display, Demod Bits
Notes	No SCPI
Instrument S/W Revision	A.01.60 or later

Scroll Up Moves one line up from the current page of the measurement results by each press.

Key Path	View/Display, CDP Graph & Metics, Composite (Summary window selected) View/Display, CDE Graph & Metics, Composite (Summary window selected) View/Display, Code Domain (Summary window selected) View/Display, Demod Bits
Notes	No SCPI
Instrument S/W Revision	A.01.60 or later

Code Domain Measurement
View/Display

First Page Moves from the current page to the first page of the measurement results by each press.

Key Path	View/Display, CDP Graph & Metics, Composite (Summary window selected) View/Display, CDE Graph & Metics, Composite (Summary window selected) View/Display, Code Domain (Summary window selected) View/Display, Demod Bits
Notes	No SCPI
Instrument S/W Revision	A.01.60 or later

Last Page Moves from the current page to the last page of the measurement results by each press.

Key Path	View/Display, CDP Graph & Metics, Composite (Summary window selected) View/Display, CDE Graph & Metics, Composite (Summary window selected) View/Display, Code Domain (Summary window selected) View/Display, Demod Bits
Notes	No SCPI
Instrument S/W Revision	A.01.60 or later

TD-SCDMA Modulation Accuracy Measurement provides the properties/methods for measuring the composite errors in TD-SCDMA transmitter. For more details, see [Modulation Accuracy Measurement Description](#) below.

This topic contains the following sections:

[Remote Commands for Modulation Accuracy](#)

[Measurement Results for Modulation Accuracy Measurement](#)

Remote Commands for Modulation Accuracy

The following commands are used to retrieve the measurement results:

The general functionality of CONFigure, FETCh, MEASure, and READ are described at the beginning of this section.

CONFigure:EVM

CONFigure:EVM:NDEFault

FETCh:EVM[n] ?

INITiate:EVM

MEASure:EVM[n] ?

READ:EVM[n] ?

Measurement Results for Modulation Accuracy Measurement

For each result, the following heading is used to represent its format and precision.

#.Result Name (type of number) [unit] <explanation>

Type of number includes double, float and integer.

Index: n	Results Returned
0	<p>I/Q Capture Data Trace (float) [volt] <2 * capture interval in second * sample rate></p> <p>Returns unprocessed I/Q trace data of Capture Interval, as a series of trace point values, in volts. The I values are listed first in each pair, using the 0 through even-indexed values. The Q values are the odd-indexed values.</p> <p>The sample rate is 3.75MHz in this measurement.</p> <p>If no data is captured, one NaN will be returned.</p>

1 (or not specified)

Returns the following 34 comma-separated scalar results, in the following order:

1. Rho (Average) (float) [NA]

Averaged composite Rho (in average cycle) in the selected timeslot and sub-frame.

2. Rho (Peak Hold) (float) [NA]

Peak/Maximum composite Rho (in average cycle) in the selected timeslot and sub-frame.

3. RMS EVM (Average) (float) [% rms]

Averaged composite RMS EVM (in average cycle) in the selected timeslot and sub-frame.

4. RMS EVM (Peak Hold) (float) [% rms]

Peak/Maximum composite RMS EVM (in average cycle) in the selected timeslot and sub-frame.

5. Peak EVM (Average) (float) [% pk]

Averaged composite peak EVM (in average cycle) in the selected timeslot and sub-frame.

6. Peak EVM (Peak Hold) (float) [% pk]

Peak/Maximum composite peak EVM (in average cycle) in the selected timeslot and sub-frame.

7. RMS Magnitude Error (Average) (float) [% rms]

Averaged composite RMS magnitude error (in average cycle) in the selected timeslot and sub-frame.

8. RMS Magnitude Error (Peak Hold) (float) [% rms]

Peak/Maximum composite RMS magnitude error (in average cycle) in the selected timeslot and sub-frame.

9. Peak Magnitude Error (Average) (float) [% pk]

Averaged composite peak magnitude error in the selected timeslot and sub-frame.

10. Peak Magnitude Error (Peak Hold) (float) [% pk]

Peak/Maximum composite peak magnitude error in the selected timeslot and sub-frame.

11. RMS Phase Error (Average) (float) [° rms]

Averaged composite RMS phase error (in average cycle) in the selected timeslot and sub-frame.

12. RMS Phase Error (Peak Hold) (float) [° rms]

Peak/Maximum composite RMS phase error (in average cycle) in the selected timeslot and sub-frame.

13. Peak Phase Error (Average) (float) [° pk]

Averaged composite peak phase error (in average cycle) in the selected timeslot and sub-frame.

1 (or not specified)

(Continued)

14. Peak Phase Error (Peak Hold) (float) [$^{\circ}$ pk]

Peak/Maximum composite peak phase error (in average cycle) in the selected timeslot and sub-frame.

15. Peak CDE (Average) (float) [dB]

Averaged Peak code domain error of all code channels (in average cycle), including active code channels and inactive code channels.

When DwPTS or UpPTS is selected, NaN will be returned.

16. Peak CDE (Peak Hold) (float) [dB]

Peak/Maximum Peak code domain error of all code channels (in average cycle), including active code channels and inactive code channels.

When DwPTS or UpPTS is selected, NaN will be returned.

17. Peak Active CDE (Average) (float) [dB]

Averaged Peak Code Domain Error of active code channels (in average cycle).

If no active channel is detected, NaN will be returned.

When DwPTS or UpPTS is selected, NaN will be returned.

18. Peak Active CDE (Peak Hold) (float) [dB]

Peak/Maximum Peak Code Domain Error of active code channels (in average cycle).

If no active channel is detected, NaN will be returned.

When DwPTS or UpPTS is selected, NaN will be returned.

19. Frequency Error (Average) (float) [Hz]

Averaged composite frequency error (in average cycle) in the selected timeslot and sub-frame.

20. Frequency Error (Peak Hold) (float) [Hz]

Peak/Maximum composite frequency error (in average cycle) in the selected timeslot and sub-frame.

21. IQ Offset (Average) (float) [dB]

Averaged composite IQ offset (in average cycle) in the selected timeslot and sub-frame.

22. IQ Offset (Peak Hold) (float) [dB]

Peak/Maximum composite IQ offset (in average cycle) in the selected timeslot and sub-frame.

23. Quad Error (Average) (float) [$^{\circ}$]

Averaged composite Quad Error (in average cycle) in the selected timeslot and sub-frame.

24. Quad Error (Peak Hold) (float) [$^{\circ}$]

Peak/Maximum composite Quad Error (in average cycle) in the selected timeslot and sub-frame.

1 (or not specified)

(Continued)

25. Gain Imbalance (Average) (float) [dB]

Averaged composite gain imbalance (in average cycle) in the selected timeslot and sub-frame.

26. Gain Imbalance (Peak Hold) (float) [dB]

Peak/Maximum composite gain imbalance (in average cycle) in the selected timeslot and sub-frame.

27. Time Offset (Average) (float) [chips]

Averaged composite timing error (in average cycle) in chips, relative to the timing reference (DwPTS/UpPTS/Trig)

28. Time Offset (Peak Hold) (float) [chips]

Peak/Maximum composite timing error (in average cycle) in chips, relative to the timing reference (DwPTS/UpPTS/Trig)

29. Position of Peak CDE - Code Length (Peak Hold) (float) [NA]

Code channel number of Peak/Maximum Peak CDE (in average cycle) is SX(Y). X is the OVFSF code length (1,2,4,8,16), Y is the OVFSF code index (0, ... X-1). OVFSF code length X is returned.

When DwPTS or UpPTS is selected, NaN will be returned.

30. Position of Peak CDE - Code Index (Peak Hold) (float) [NA]

Code channel number of Peak/Maximum Peak CDE (in average cycle) is SX(Y). X is the OVFSF code length (1,2,4,8,16), Y is the OVFSF code index (0, ... X-1). OVFSF Code index Y is returned.

When DwPTS or UpPTS is selected, NaN will be returned.

31. Position of Peak Active CDE - Code Length (Peak Hold) (float) [NA]

Code channel number of Peak/Maximum Peak Active CDE (in average cycle) is SX(Y). X is the OVFSF length (1,2,4,8,16), Y is the OVFSF code index (0, ..., X-1). OVFSF code length X is returned.

If no active channel is detected, NaN will be returned.

When DwPTS or UpPTS is selected, NaN will be returned.

32. Position of Peak Active CDE - Code Index (Peak Hold) (float) [NA]

Code channel number of Peak/Maximum Peak Active CDE (in average cycle) is SX(Y). X is the OVFSF code length (1,2,4,8,16), Y is the OVFSF code index (0, ..., X-1). OVFSF code index Y is returned.

If no active channel is detected, NaN will be returned.

When DwPTS or UpPTS is selected, NaN will be returned.

33. Number of Active Channels (float) [NA]

Number of active channels in the selected timeslot and sub-frame.

34. Total Data Power (float) [dBm]

The total data part power of the selected timeslot and sub-frame.

- 2 Filtered Analysis Sub-frame Data Trace (float) [Volt] <2*4*6432>
 Return I/Q trace data of RRC filtered selected analysis sub-frame, as a series of trace point values, in volts. There are 4 I/Q pair samples per chip. The I values are listed first in each pair, using the 0 through even-indexed values. The Q values are the odd-indexed values.
 There are 6400 chips in a sub-frame. There are extra 16 chips at the head the sub-frame and extra 16 chips at the end of the sub-frame.
- 3 Un-normalized I/Q Measured Polar Data Trace (float) [Volt] <2*848>
 Return unprocessed I/Q trace data of selected timeslot and sub-frame, as a series of trace point values, in volts. The I values are listed first in each pair, using the 0 through even-indexed values. The Q values are the odd-indexed values.
 When the analyzed time slot is inactive, one NaN will be returned.
- 4 Normalized I/Q Measured Polar Data Trace (float) [dB] <2*848>
 Return unprocessed I/Q trace data of selected timeslot and sub-frame, as a series of trace point values, in dB. The I values are listed first in each pair, using the 0 through even-indexed values. The Q values are the odd-indexed values.
 When the analyzed time slot is inactive, one NaN will be returned.
- 5 Magnitude Error vs. Chip Trace (float) [dB] <848>
 Return composite magnitude error vs. chip data, as a series of comma-separated trace points. The result is a series of floating point numbers.
 When the analyzed time slot is inactive, one NaN will be returned.
- 6 Phase Error vs. Chip Trace (float) [dB] <848>
 Return composite phase error vs. chip data, as a series of comma-separated trace points. The result is a series of floating point numbers.
 When the analyzed time slot is inactive, one NaN will be returned.
- 7 EVM vs. Chip Trace (float) [dB] <848>
 Return composite EVM error vs. chip data, as a series of comma-separated trace points. The result is a series of floating point numbers.
 When the analyzed time slot is inactive, one NaN will be returned.

8 Code Length Vector (float) [NA] <16>

Return the vector containing information of the spreading code length of each code channel, active or inactive, in the specified timeslot.

There are 16 numbers in this vector. For the active channel, if its code length is less than the max spreading code length 16, the filled length value is duplicated (16/spreading code length) times. For the inactive channel, it is set to 16. The purpose of this vector is providing the code length information for each value in Active Flag Vector, Un-normalized Code Domain Power Vector, Normalized Code Domain Power Vector, Un-normalized Code Domain Error Vector, and Normalized Code Domain Error Vector.

Its data are lined according to the increasing code index,

Example:

Configuration1: There are five active code channels in one timeslot, C16(0), C8(1), C16(5), C4(2) and C8(7). Like this,



And the yellow block denotes inactive channel.

So the values in this vector should be {16, 16, 8, 8, 16, 16, 16, 16, 4, 4, 4, 4, 16, 16, 8, 8}.

Note: When the measurement fails to get synchronization or the slot under test is DwPTS/UpPTS or inactive, and so on, 16 NaN will be returned.

9 Channel Active Flag Vector (float) [NA] <16>

Return the vector containing information whether or not the specified channel is active, as a series of comma-separated points. “1” denotes active, and “0” denotes inactive.

There are 16 numbers in this vector. If the active channel’s code length (specified by the value on the same position within the Code Length Vector) is less than the max spreading code length 16, the flag is duplicated (16/spreading code length) times. Its data are lined according to the increasing code index.

Take Configuration 1 for example, the values in this vector should be {1, 0, 1, 1, 0, 1, 0, 0, 1, 1, 1, 1, 0, 0, 1, 1}.

Note: When the measurement fails to get synchronization or the slot under test is DwPTS/UpPTS or inactive, and so on, all the flags in this vector are 0.0.

10 Un-normalized Code Domain Power Trace (float) [dBm] <16>

Return the vector containing un-normalized CDP information for the specified code channel, as a series of comma-separated points.

There are 16 numbers in this vector. If the active channel’s code length (specified by the value on the same position within the Code Length Vector) is less than the max spreading code length 16, the power is duplicated (16/spreading code length) times. Its data are lined according to the increasing code index.

Take Configuration 1 for example, the values in this vector should be {P1, Px, P2, P2, Px, P3, Px, Px, P4, P4, P4, P4, Px, Px, P5, P5}. Px is the power on code channel C16(x).

Note: When the measurement fails to get the result, such as: failing to in synchronization or the slot under test is DwPTS/UpPTS or inactive, 16 NaN will be returned.

- 11 Normalized Code Domain Power Trace (float) [dB] <16>
- Return the vector containing normalized CDP information for the specified code channel, as a series of comma-separated points.
- There are 16 numbers in this vector. If the active channel's code length (specified by the value on the same position within the Code Length Vector) is less than the max spreading code length 16, the power is duplicated (16/spreading code length) times. Its data are lined according to the increasing code index.
- Take Configuration 1 for example, the values in this vector should be {P1, Px, P2, P2, Px, P3, Px, Px, P4, P4, P4, P4, Px, Px, P5, P5}. Px is the power on code channel C16(x).
-
- Note: When the measurement fails to get the result, such as: failing to in synchronization or the slot under test is DwPTS/UpPTS or inactive, 16 NaN will be returned.
- 12 Normalized Code Domain Error Trace (float) [dB] < 16 >
- Return the vector containing normalized CDE information for the specified code channel, as a series of comma-separated points.
- There are 16 numbers in this vector. If the active channel's code length (specified by the value on the same position within the Code Length Vector) is less than the max spreading code length 16, the error is duplicated (16/spreading code length) times. Its data are lined according to the increasing code index.
- Take Configuration 1 for example, the values in this vector should be {E1, Ex, E2, E2, Ex, E3, Ex, Ex, E4, E4, E4, E4, Ex, Ex, E5, E5}. Ex is the power on code channel C16(x).
- Note: When the measurement fails to get the result, such as: failing to in synchronization or the slot under test is DwPTS/UpPTS or inactive, 16 NaN will be returned.
- 13 Total Power vs. Timeslots Trace (float) [dBm] <9>
- Return absolute power measurement of composite signals for each timeslot within the analyzed sub-frame. The sequence of timeslot is TS0, DwPTS, UpPTS, TS1, TS2, TS3, TS4, TS5, and TS6
- Note: When the measurement fails, such as: failing to in synchronization, 9 NaN will be returned.
- 14 Midamble Power vs. Timeslots Trace (float) [dBm] <9>
- Return absolute power measurement of composite midamble signals for each timeslot within the analyzed sub-frame. The sequence of timeslot is TS0, DwPTS, UpPTS, TS1, TS2, TS3, TS4, TS5, and TS6.
- The midamble power of DwPTS/UpPTS returned is same as the total power of DwPTS/UpPTS.
- Note: When the measurement fails, such as: failing to in synchronization, 9 NaN will be returned.
- 15 Data Power 1 vs. Timeslots Trace (float) [dBm] <9>
- Return absolute power measurement of composite data signals before midamble for each timeslot within the analyzed sub-frame. The sequence of timeslot is TS0, DwPTS, UpPTS, TS1, TS2, TS3, TS4, TS5, and TS6.
- The data power of DwPTS/UpPTS returned is same as the total power of DwPTS/UpPTS.
- Note: When the measurement fails, such as: failing to in synchronization, 9 NaN will be returned.

Modulation Accuracy (Composite EVM) Measurement

- 16 Data Power 2 vs. Timeslots Trace (float) [dBm] <9>
Return absolute power measurement of composite data signals after midamble for each timeslot within the analyzed sub-frame. The sequence of timeslot is TS0, DwPTS, UpPTS, TS1, TS2, TS3, TS4, TS5, and TS6.
The data power of DwPTS/UpPTS returned is same as the total power of DwPTS/UpPTS.
Note: When the measurement fails, such as: failing to in synchronization, 9 NaN will be returned.
- 17 Time Offset vs. Timeslots Trace (float) [chips] <9>
Return the difference in time (in chips) between the measured and ideal start times for each timeslot within the analyzed sub-frame relative to the specified time reference. The sequence of the timeslots is TS0, DwPTS, UpPTS, TS1, TS2, TS3, TS4, TS5, and TS6, totally 9 timeslots.
Either the DwPTS, UpPTS, or Trigger Point as the time reference can be set as Timing Ref in Demod parameters
Note: When the measurement fails, such as: failing to in synchronization or the Timing Ref not exist, 9 NaN will be returned.
- 18 Limit PASS/FAIL Trace (float) [NA] <5>
Return the PASS/FAIL (0/1) message of the current selected device (BTS or MS) in the sequence of:
1st, Composite RMS EVM
2nd, Composite Peak EVM
3rd, Composite Rho
4th, Peak CDE
5th, Composite Frequency Error
Coupled with device. When the current device is set BTS, the trace indicates the limit Pass/Fail of BTS; When the device is set MS, the trace indicates the limit Pass/Fail of MS.
Note: When the measurement fails, such as: failing to in synchronization, all the values in this vector will be 1.0.
- 19 Time Slot Active Flag Trace (float) [NA] <9>
Return the Active/Inactive (1/0) message of the 9 time slots within the selected analysis sub-frame. The sequence of the timeslots is TS0, DwPTS, UpPTS, TS1, TS2, TS3, TS4, TS5, and TS6.
Note: When the measurement fails to get synchronization, all the values in this vector will be NaN.

Modulation Accuracy Measurement Description

Modulation Accuracy Measurement provides the properties/methods for measuring the composite errors in TD-SCDMA transmitter. Composite signal here means all the code channels. The results comprise of Rho, EVM, Magnitude Error, Phase Error, Peak CDE, Peak Active CDE, Freq error, IQ offset, Quad Error, Gain Imbalance, and Timing Offset, etc..

Key Path	Meas
Instrument S/W Revision	A.01.60 or later

Amplitude (AMPTD) Y Scale

The AMPLITUDE Y Scale key accesses the menu to set the desired vertical scale and associated settings. It specifies AMPLITUDE Y Scale setting when EVM, Magnitude Error, Phase Error, Code Domain Power, or Capture Time Data Trace Window is active.

Key Path	Front-panel key
Instrument S/W Revision	A.01.60 or later

Ref Value

This key allows you to set the display Y reference value. The key is active in EVM Window, Magnitude Error Window, Phase Error Window, Code Domain Power Window, and Capture Time Data Trace Window.

Key Path	AMPTD Y Scale
Instrument S/W Revision	A.01.60 or later

Y Ref Value (I/Q Error View – Magnitude Error Window)

This key sets the reference value in the Magnitude Error window.

Remote Command	:DISPlay:EVM:VIEW2:WINDow[1]:TRACe:Y[:SCALE]:RLEVel <real> :DISPlay:EVM:VIEW2:WINDow[1]:TRACe:Y[:SCALE]:RLEVel?
Dependencies/Couplings	See Notes
Example	DISP:EVM:VIEW2:WIND:TRAC:Y:RLEV 0.0 DISP:EVM:VIEW2:WIND:TRAC:Y:RLEV?
Key Path	AMPTD Y Scale
Mode	TD-SCDMA
Notes	VIEW2 : I/Q Error View WINDow[1]: Mag Error Window on I/Q Error View If Auto Scale is set to On, this value is automatically determined by the measurement result. When you set this value manually, Auto Scale is automatically set to Off.
Preset	0.0
State Saved	Saved in instrument state.
Min	0.0
Max	1000.0

Modulation Accuracy (Composite EVM) Measurement
Amplitude (AMPTD) Y Scale

Test MIN/MAX/DEF	No
Test UP/DOWN	1, 2, 5, 10
Instrument S/W Revision	A.01.60 or later

Y Ref Value (I/Q Error View – Phase Error Window)

This key sets the reference value in the phase error window.

Remote Command	:DISPlay:EVM:VIEW2:WINDow2:TRACe:Y[:SCALe]:RLEVel <real> :DISPlay:EVM:VIEW2:WINDow2:TRACe:Y[:SCALe]:RLEVel?
Dependencies/Couplings	See Notes
Example	DISP:EVM:VIEW2:WIND2:TRAC:Y:RLEV 0.0 DISP:EVM:VIEW2:WIND2:TRAC:Y:RLEV?
Key Path	AMPTD Y Scale
Mode	TD-SCDMA
Notes	VIEW2 : I/Q Error View WINDow2: Phase Error Window on I/Q Error View If Auto Scale is set to On, this value is automatically determined by the measurement result. When you set this value manually, Auto Scale is automatically set to Off.
Preset	0.0
State Saved	Saved in instrument state.
Min	0.0
Max	1000.0
Test MIN/MAX/DEF	No
Test UP/DOWN	1, 2, 5, 10
Instrument S/W Revision	A.01.60 or later

Y Ref Value (I/Q Error View – EVM Window)

This key sets the reference value in the EVM window.

Remote Command	:DISPlay:EVM:VIEW2:WINDow3:TRACe:Y[:SCALe]:RLEVel <real> :DISPlay:EVM:VIEW2:WINDow3:TRACe:Y[:SCALe]:RLEVel?
Dependencies/Couplings	See Notes

Example	DISP:EVM:VIEW2:WIND3:TRAC:Y:RLEV 0.0 DISP:EVM:VIEW2:WIND3:TRAC:Y:RLEV?
Key Path	AMPTD Y Scale
Mode	TD-SCDMA
Notes	VIEW2 : I/Q Error View WINDow3: EVM Window on I/Q Error View If Auto Scale is set to On, this value is automatically determined by the measurement result. When you set this value manually, Auto Scale is automatically set to Off.
Preset	0.0
State Saved	Saved in instrument state.
Min	0.0
Max	1000.0
Test MIN/MAX/DEF	No
Test UP/DOWN	1, 2, 5, 10
Instrument S/W Revision	A.01.60 or later

Y Ref Value (Code Domain Power and Metrics View – Code Domain Power Window)

This key sets the power reference value for the power results in the Code Domain Power window.

Remote Command	:DISPlay:EVM:VIEW3:WINDow[1]:TRACe:Y[:SCALE]:RLEVel <real> :DISPlay:EVM:VIEW3:WINDow[1]:TRACe:Y[:SCALE]:RLEVel?
Dependencies/Couplings	See Notes
Example	DISP:EVM:VIEW3:WIND:TRAC:Y:RLEV 0.0 DISP:EVM:VIEW3:WIND:TRAC:Y:RLEV?
Key Path	AMPTD Y Scale
Mode	TD-SCDMA
Notes	VIEW3 : Code Domain Power and Metrics View WINDow[1]: Code Domain Power and Metrics Window on Code Domain Power View If Auto Scale is set to On, this value is automatically determined by the measurement result. When you set this value manually, Auto Scale is automatically set to Off. Coupled with Normalize: If Normalize is On, the Unit is dB; Otherwise, the Unit is dBm

Modulation Accuracy (Composite EVM) Measurement
Amplitude (AMPTD) Y Scale

Preset	0.0
State Saved	Saved in instrument state.
Min	-1000.0
Max	1000.0
Test MIN/MAX/DEF	No
Test UP/DOWN	1, 2, 5, 10
Instrument S/W Revision	A.01.60 or later

Y Ref Value (Capture Time Summary – Capture Time Data Trace Window)

This key sets the reference value of the results in the Capture Time Data Trace window.

Remote Command	:DISPlay:EVM:VIEW4:WINDow[1]:TRACe:Y[:SCALe]:RLEVel <real> :DISPlay:EVM:VIEW4:WINDow[1]:TRACe:Y[:SCALe]:RLEVel?
Dependencies/Couplings	See Notes
Example	DISP:EVM:VIEW4:WIND:TRAC:Y:RLEV 0.0 DISP:EVM:VIEW4:WIND:TRAC:Y:RLEV?
Key Path	AMPTD Y Scale
Mode	TD-SCDMA
Notes	VIEW4 : Capture Time Summary View WINDow[1]: Capture Time Data Trace Window on Capture Time Summary View If Auto Scale is set to On, this value is automatically determined by the measurement result. When you set this value manually, Auto Scale is automatically set to Off.
Preset	0.0
State Saved	Saved in instrument state.
Min	-1000.0
Max	1000.0
Test MIN/MAX/DEF	No
Test UP/DOWN	1, 2, 5, 10
Instrument S/W Revision	A.01.60 or later

Attenuation

Operation of this key is identical across several measurements. For details about this key, see [“Attenuation” on page 1037](#) in the "Common Measurement Functions".

Range

Operation of this key is identical across several measurements. For details about this key, see “Range” on page 1043 in the "Common Measurement Functions".

Scale/Div

This key allows you to set Y Scale/Div. This key is active in EVM Window, Mag Error Window, Phase Error Window, Code Domain Power Window, and Capture Time Data Trace Window.

Key Path	AMPTD Y Scale
Instrument S/W Revision	A.01.60 or later

Y Scale/Div (I/Q Error View – Magnitude Error Window)

This key sets the sensitivity of measurement result in the Magnitude Error window.

Remote Command	:DISPlay:EVM:VIEW2:WINDow[1]:TRACe:Y[:SCALe]:PDIVision <real> :DISPlay:EVM:VIEW2:WINDow[1]:TRACe:Y[:SCALe]:PDIVision?
Dependencies/Couplings	See Notes
Example	DISP:EVM:VIEW2:WIND:TRAC:Y:PDIV 10.0 DISP:EVM:VIEW2:WIND:TRAC:Y:PDIV?
Key Path	AMPTD Y Scale
Mode	TD-SCDMA
Notes	VIEW2 : I/Q Error View WINDow[1]: Mag Error Window on I/Q Error View If Auto Scale is set to On, this value is automatically determined by the measurement result. When you set this value manually, Auto Scale is automatically set to Off.
Preset	0.1
State Saved	Saved in instrument state.
Min	0.1
Max	100.0
Test MIN/MAX/DEF	No
Test UP/DOWN	1, 2, 5, 10
Instrument S/W Revision	A.01.60 or later

Modulation Accuracy (Composite EVM) Measurement
Amplitude (AMPTD) Y Scale

Y Scale/Div (I/Q Error View – Phase Error Window)

This key sets the sensitivity of measurement result in the Phase Error window.

Remote Command	<code>:DISPlay:EVM:VIEW2:WINDow2:TRACe:Y[:SCALe]:PDIVision</code> <code><real></code> <code>:DISPlay:EVM:VIEW2:WINDow2:TRACe:Y[:SCALe]:PDIVision?</code>
Dependencies/Couplings	See Notes
Example	<code>DISP:EVM:VIEW2:WIND2:TRAC:Y:PDIV 10.0</code> <code>DISP:EVM:VIEW2:WIND2:TRAC:Y:PDIV?</code>
Key Path	AMPTD Y Scale
Mode	TD-SCDMA
Notes	VIEW2 : I/Q Error View WINDow2: Phase Error Window on I/Q Error View If Auto Scale is set to On, this value is automatically determined by the measurement result. When you set this value manually, Auto Scale is automatically set to Off.
Preset	0.1
State Saved	Saved in instrument state.
Min	0.1
Max	1000.0
Test MIN/MAX/DEF	No
Test UP/DOWN	1, 2, 5, 10
Instrument S/W Revision	A.01.60 or later

Y Scale/Div (I/Q Error View – EVM Window)

This key sets the sensitivity of measurement result in the EVM window.

Remote Command	<code>:DISPlay:EVM:VIEW2:WINDow3:TRACe:Y[:SCALe]:PDIVision</code> <code><real></code> <code>:DISPlay:EVM:VIEW2:WINDow3:TRACe:Y[:SCALe]:PDIVision?</code>
Dependencies/Couplings	See Notes
Example	<code>DISP:EVM:VIEW2:WIND3:TRAC:Y:PDIV 10.0</code> <code>DISP:EVM:VIEW2:WIND3:TRAC:Y:PDIV?</code>
Key Path	AMPTD Y Scale
Mode	TD-SCDMA

Notes	VIEW2 : I/Q Error View WINDow3: EVM Window on I/Q Error View If Auto Scale is set to On, this value is automatically determined by the measurement result. When you set this value manually, Auto Scale is automatically set to Off.
Preset	0.1
State Saved	Saved in instrument state.
Min	0.1
Max	100.0
Test MIN/MAX/DEF	No
Test UP/DOWN	1, 2, 5, 10
Instrument S/W Revision	A.01.60 or later

Y Scale/Div (Code Domain Power and Metrics View – Code Domain Power Window)

This key sets the sensitivity of the power results in the Code Domain Power window.

Remote Command	:DISPlay:EVM:VIEW3:WINDow[1]:TRACe:Y[:SCALE]:PDIVision <rel_amp1> :DISPlay:EVM:VIEW3:WINDow[1]:TRACe:Y[:SCALE]:PDIVision?
Dependencies/Couplings	See Notes
Example	DISP:EVM:VIEW3:WIND:TRAC:Y:PDIV 10.0 dB DISP:EVM:VIEW3:WIND:TRAC:Y:PDIV?
Key Path	AMPTD Y Scale
Mode	TD-SCDMA
Notes	VIEW3 : Code Domain Power and Metrics View WINDow[1]: Code Domain Power and Metrics Window on Code Domain Power View If Auto Scale is set to On, this value is automatically determined by the measurement result. When you set this value manually, Auto Scale is automatically set to Off.
Preset	10.0
State Saved	Saved in instrument state.
Min	0.1
Max	50.0
Test MIN/MAX/DEF	No
Test UP/DOWN	1, 2, 5, 10

Modulation Accuracy (Composite EVM) Measurement
Amplitude (AMPTD) Y Scale

Instrument S/W Revision A.01.60 or later

Y Scale/Div (Capture Time Summary View – Capture Time Data Trace Window)

This key sets the sensitivity of the results in the Capture Time Data Trace window.

Remote Command	:DISPlay:EVM:VIEW4:WINDow[1]:TRACe:Y[:SCALE]:PDIVision <rel_ampl> :DISPlay:EVM:VIEW4:WINDow[1]:TRACe:Y[:SCALE]:PDIVision?
Dependencies/Couplings	See Notes
Example	DISP:EVM:VIEW4:WIND:TRAC:Y:PDIV 10.0 dB DISP:EVM:VIEW4:WIND:TRAC:Y:PDIV?
Key Path	AMPTD Y Scale
Mode	TD-SCDMA
Notes	VIEW4 : Capture Time Summary View WINDow[1]: Capture Time Data Trace Window on Capture Time Summary View If Auto Scale is set to On, this value is automatically determined by the measurement result. When you set this value manually, Auto Scale is automatically set to Off.
Preset	10.0
State Saved	Saved in instrument state.
Min	0.1
Max	50.0
Test MIN/MAX/DEF	No
Test UP/DOWN	1, 2, 5, 10
Instrument S/W Revision	A.01.60 or later

Presel Center

Operation of this key is identical across several measurements. For details about this key, see [“Presel Center” on page 1049](#) in the "Common Measurement Functions".

Presel Adjust

Operation of this key is identical across several measurements. For details about this key, see [“Preselector Adjust” on page 1050](#) in the "Common Measurement Functions".

Internal Preamp

Operation of this key is identical across several measurements. For details about this key, see [“Internal](#)

Preamp” on page 1052 in the "Common Measurement Functions".

Ref Position

This key allows you to set the display reference position to either Top, Ctr (center), or Bot (Bottom). The key is active in EVM Window, Magnitude Error Window, Phase Error Window, Code Domain Power Window, and Capture Time Data Trace Window.

Key Path	AMPTD Y Scale
Instrument S/W Revision	A.01.60 or later

Y Ref Position (I/Q Error View – Magnitude Error Window)

This key sets the reference position of the vertical axis in the Magnitude Error window.

Remote Command	:DISPlay:EVM:VIEW2:WINDow[1]:TRACe:Y[:SCALE]:RPOSition TOP CENTer BOTTom :DISPlay:EVM:VIEW2:WINDow[1]:TRACe:Y[:SCALE]:RPOSition?
Example	DISP:EVM:VIEW2:WIND:TRAC:Y:RPOS TOP DISP:EVM:VIEW2:WIND:TRAC:Y:RPOS?
Key Path	AMPTD Y Scale
Mode	TD-SCDMA
Notes	VIEW2 : I/Q Error View WINDow[1]: Mag Error Window on I/Q Error View
Preset	CENTer
State Saved	Saved in instrument state.
Range	Top Ctr Bot
Instrument S/W Revision	A.01.60 or later

Y Ref Position (I/Q Error View – Phase Error Window)

This sets the reference position of the vertical axis in the Phase Error window.

Remote Command	:DISPlay:EVM:VIEW2:WINDow2:TRACe:Y[:SCALE]:RPOSition TOP CENTer BOTTom :DISPlay:EVM:VIEW2:WINDow2:TRACe:Y[:SCALE]:RPOSition?
Example	DISP:EVM:VIEW2:WIND2:TRAC:Y:RPOS TOP DISP:EVM:VIEW2:WIND2:TRAC:Y:RPOS?
Key Path	AMPTD Y Scale
Mode	TD-SCDMA

Modulation Accuracy (Composite EVM) Measurement
Amplitude (AMPTD) Y Scale

Notes	VIEW2 : I/Q Error View WINDow2: Phase Error Window on I/Q Error View
Preset	CENTer
State Saved	Saved in instrument state.
Range	Top Ctr Bot
Instrument S/W Revision	A.01.60 or later

Y Ref Position (I/Q Error View – EVM Window)

This key sets the reference position of the vertical axis in the EVM window.

Remote Command	:DISPlay:EVM:VIEW2:WINDow3:TRACe:Y[:SCALe]:RPOSition TOP CENTer BOTTom :DISPlay:EVM:VIEW2:WINDow3:TRACe:Y[:SCALe]:RPOSition?
Example	DISP:EVM:VIEW2:WIND3:TRAC:Y:RPOS TOP DISP:EVM:VIEW2:WIND3:TRAC:Y:RPOS?
Key Path	AMPTD Y Scale
Mode	TD-SCDMA
Notes	VIEW2 : I/Q Error View WINDow3: EVM Window on I/Q Error View
Preset	BOTTom
State Saved	Saved in instrument state.
Range	Top Ctr Bot
Instrument S/W Revision	A.01.60 or later

Y Ref Position (Code Domain Power and Metrics View – Code Domain Power Window)

This key sets the reference position of the vertical in the Code Domain Power window.

Remote Command	:DISPlay:EVM:VIEW3:WINDow[1]:TRACe:Y[:SCALe]:RPOSition TOP CENTer BOTTom :DISPlay:EVM:VIEW3:WINDow[1]:TRACe:Y[:SCALe]:RPOSition?
Example	DISP:EVM:VIEW3:WIND:TRAC:Y:RPOS TOP DISP:EVM:VIEW3:WIND:TRAC:Y:RPOS?
Key Path	AMPTD Y Scale
Mode	TD-SCDMA

Notes	VIEW3 : Code Domain Power and Metrics View WINDow[1]: Code Domain Power and Metrics Window on Code Domain Power View
Preset	TOP
State Saved	Saved in instrument state.
Range	Top Ctr Bot
Instrument S/W Revision	A.01.60 or later

Y Ref Position (Capture Time Summary View – Capture Time Data Trace Window)

This key sets the reference position of the vertical axis in the capture time data trace window.

Remote Command	:DISPlay:EVM:VIEW4:WINDow[1]:TRACe:Y[:SCALe]:RPOSition TOP CENTer BOTTom :DISPlay:EVM:VIEW4:WINDow[1]:TRACe:Y[:SCALe]:RPOSition?
Example	DISP:EVM:VIEW4:WIND:TRAC:Y:RPOS TOP DISP:EVM:VIEW4:WIND:TRAC:Y:RPOS?
Key Path	AMPTD Y Scale
Mode	TD-SCDMA
Notes	VIEW4 : Capture Time Summary View WINDow[1]: Capture Time Data Trace Window on Capture Time Summary View
Preset	TOP
State Saved	Saved in instrument state.
Range	Top Ctr Bot
Instrument S/W Revision	A.01.60 or later

Auto Scale

Toggles the Auto Scale function between On and Off. When Auto Scale is On, it will result in automatically determining scale per division and reference values based on the measurement results.

When you set a value to either Scale/Div or Ref Value manually, Auto Scale automatically changes to Off.

Key Path	AMPTD Y Scale
Instrument S/W Revision	A.01.60 or later

Y Auto Scale (I/Q Error View – Magnitude Error Window)

When Auto Scale is On, it will result in automatically displaying the scale per division and reference

Modulation Accuracy (Composite EVM) Measurement
Amplitude (AMPTD) Y Scale

value results for the vertical axis in the Magnitude Error window.

Remote Command	:DISPlay:EVM:VIEW2:WINDow [1] :TRACe:Y[:SCALe]:COUPle 0 1 OFF ON :DISPlay:EVM:VIEW2:WINDow [1] :TRACe:Y[:SCALe]:COUPle?
Dependencies/Couplings	See Notes
Example	DISP:EVM:VIEW2:WIND:TRAC:Y:COUP ON DISP:EVM:VIEW2:WIND:TRAC:Y:COUP?
Key Path	AMPTD Y Scale
Mode	TD-SCDMA
Notes	VIEW2 : I/Q Error View WINDow[1]: Mag Error Window on I/Q Error View When this parameter is set to On, it will activate the scale coupling function that automatically determines scale per division and reference values based on the measurement results. When you set a value to either Scale/Div or Ref Value manually, Auto Scale is automatically set to Off.
Preset	ON
State Saved	Saved in instrument state.
Range	On Off
Instrument S/W Revision	A.01.60 or later

Y Auto Scale (I/Q Error View – Phase Error Window)

When Auto Scale is On, it will result in automatically displaying the scale per division and reference value results for the vertical axis in the Phase Error window.

Remote Command	:DISPlay:EVM:VIEW2:WINDow2:TRACe:Y[:SCALe]:COUPle 0 1 OFF ON :DISPlay:EVM:VIEW2:WINDow2:TRACe:Y[:SCALe]:COUPle?
Dependencies/Couplings	See Notes
Example	DISP:EVM:VIEW2:WIND2:TRAC:Y:COUP ON DISP:EVM:VIEW2:WIND2:TRAC:Y:COUP?
Key Path	AMPTD Y Scale
Mode	TD-SCDMA

Notes	VIEW2 : I/Q Error View WINDow2: Phase Error Window on I/Q Error View When this parameter is set to On, it will activate the scale coupling function that automatically determines scale per division and reference values based on the measurement results. When you set a value to either Scale/Div or Ref Value manually, Auto Scale is automatically set to Off.
Preset	ON
State Saved	Saved in instrument state.
Range	On Off
Instrument S/W Revision	A.01.60 or later

Y Auto Scale (I/Q Error View – EVM Window)

When Auto Scale is On, it will result in automatically displaying the scale per division and reference value results for the vertical axis in EVM window.

Remote Command	:DISPlay:EVM:VIEW2:WINDow3:TRACe:Y[:SCALE]:COUPlE 0 1 OFF ON :DISPlay:EVM:VIEW2:WINDow3:TRACe:Y[:SCALE]:COUPlE?
-----------------------	---

Dependencies/Couplings

See Notes

Example

DISP:EVM:VIEW2:WIND3:TRAC:Y:COUP ON
DISP:EVM:VIEW2:WIND3:TRAC:Y:COUP?

Key Path

AMPTD Y Scale

Mode

TD-SCDMA

Notes

VIEW2 : I/Q Error View

WINDow3: EVM Window on I/Q Error View

When this parameter is set to On, it will activate the scale coupling function that automatically determines scale per division and reference values based on the measurement results. When you set a value to either Scale/Div or Ref Value manually, Auto Scale is automatically set to Off.

Preset

ON

State Saved

Saved in instrument state.

Range

On|Off

Instrument S/W Revision

A.01.60 or later

Y Auto Scale (Code Domain Power and Metrics View – Code Domain Power Window)

When Auto Scale is On, it will result in automatically displaying the scale per division and reference

Modulation Accuracy (Composite EVM) Measurement
Amplitude (AMPTD) Y Scale

value results in the Code Domain Power window.

Remote Command	<code>:DISPlay:EVM:VIEW3:WINDow[1]:TRACe:Y[:SCALe]:COUPle 0 1 OFF ON</code> <code>:DISPlay:EVM:VIEW3:WINDow[1]:TRACe:Y[:SCALe]:COUPle?</code>
Dependencies/Couplings	See Notes
Example	<code>DISP:EVM:VIEW3:WIND:TRAC:Y:COUP ON</code> <code>DISP:EVM:VIEW3:WIND:TRAC:Y:COUP?</code>
Key Path	AMPTD Y Scale
Mode	TD-SCDMA
Notes	VIEW3 : Code Domain Power and Metrics View WINDow[1]: Code Domain Power and Metrics Window on Code Domain Power View When this parameter is set to On, it will activate the scale coupling function that automatically determines scale per division and reference values based on the measurement results. When you set a value to either Scale/Div or Ref Value manually, Auto Scale is automatically set to Off.
Preset	ON
State Saved	Saved in instrument state.
Range	On Off
Instrument S/W Revision	A.01.60 or later

Y Auto Scale (Capture Time Summary View – Capture Time Data Trace Window)

When Auto Scale is On, this function automatically displays the scale per division and reference value results in the Capture Time Data Trace window.

Remote Command	<code>:DISPlay:EVM:VIEW4:WINDow[1]:TRACe:Y[:SCALe]:COUPle 0 1 OFF ON</code> <code>:DISPlay:EVM:VIEW4:WINDow[1]:TRACe:Y[:SCALe]:COUPle?</code>
Dependencies/Couplings	See Notes
Example	<code>DISP:EVM:VIEW4:WIND:TRAC:Y:COUP ON</code> <code>DISP:EVM:VIEW4:WIND:TRAC:Y:COUP?</code>
Key Path	AMPTD Y Scale
Mode	TD-SCDMA

Notes	<p>VIEW4 : Capture Time Summary View</p> <p>WINDow[1]: Capture Time Data Trace Window on Capture Time Summary View</p> <p>When this parameter is set to On, it will activate the scale coupling function that automatically determines scale per division and reference values based on the measurement results. When you set a value to either Scale/Div or Ref Value manually, Auto Scale is automatically set to Off.</p>
Preset	ON
State Saved	Saved in instrument state.
Range	On Off
Instrument S/W Revision	A.01.60 or later

Auto Couple

Operation of this key is identical across several measurements. For details about this key, see “[AUTO COUPLE](#)” on page 1055 in the “Common Measurement Functions”.

BW

There is no BW functionality supported in the Modulation Accuracy measurement.

Key Path	Front-panel key
Instrument S/W Revision	A.01.60 or later

Cont

Operation of this key is identical across several measurements. For details about this key, see “[Cont \(Continuous Measurement/Sweep\)](#)” on page 1059 in the "Common Measurement Functions".

FREQ Channel

Operation of this key is identical across several measurements. For details about this key, see FREQ Channel [“Frequency/Channel” on page 1061](#) for more information.

Center Freq

Allows you to specify the center frequency of the analyzer. For details about this key, see [“Center Freq” on page 1061](#) in the "Common Measurement Functions".

CF Step

CF Step changes the step size for the center frequency. Sets and gets the step value for center frequency. For details about this key, see [“CF Step” on page 1063](#) in the "Common Measurement Functions".

Carrier Config

Allows you to adjust the carrier config parameters.

Key Path	FREQ/Channel
Instrument S/W Revision	A.01.60 or later

Carriers

Sets the total carriers that present in the signal.

Remote Command	<code>[:SENSe] :TDEMod:CARrier:NUMber <integer></code> <code>[:SENSe] :TDEMod:CARrier:NUMber?</code>
Example	TDEM:CAR:NUM 1 TDEM:CAR:NUM?
Key Path	FREQ/Channel, Carrier Config
Mode	TD-SCDMA
Preset	1
State Saved	Saved in instrument state.
Min	1
Max	15
Test MIN/MAX/DEF	Yes
Instrument S/W Revision	A.01.60 or later

Carrier Result

Sets the carrier to be analyzed.

Remote Command	<code>[:SENSe] :TDEMod:CARrier:RESult <integer></code> <code>[:SENSe] :TDEMod:CARrier:RESult?</code>
Example	TDEM:CAR:RES 1 TDEM:CAR:RES?
Key Path	FREQ/Channel, Carrier Config
Mode	TD-SCDMA
Preset	1
State Saved	Saved in instrument state.
Min	1
Max	15
Test MIN/MAX/DEF	Yes
Instrument S/W Revision	A.01.60 or later

Input/Output

Operation of this key is identical across several measurements. For details about this key, see [“Input/Output” on page 1065](#) in the "Common Measurement Functions".

Marker

Accesses a menu that enables you to select, set up and control the markers for the current measurement. See Marker “Marker” on page 1123 in the "Common Measurement Functions" for more information.

Key Path	Front Panel Key
Instrument S/W Revision	A.01.60 or later

Select Marker

Accesses a menu that enables you to select, set up and control the markers for the current measurement.

Key Path	Front Panel
Instrument S/W Revision	A.01.60 or later

Marker Type

Sets the marker control mode. If the selected marker is Off, pressing Marker sets it to Normal and places it at the center of the screen on the trace determined by the **Marker Trace** rules. At the same time, reference value of the selected marker appears on the Active Function area.

Active Function Display: Marker X-axis value

Default Active Function: the active function for the selected marker's current control mode. If the current control mode is Off, there is no active function and the active function is turned off.

The marker X axis value entered in the active function area will display the marker value to its full entered precision.

Remote Command	:CALCulate:EVM:MARKer [1] 2 3 4 5 6 7 8 9 10 11 12 :MODE POSITION DELTA OFF :CALCulate:EVM:MARKer [1] 2 3 4 5 6 7 8 9 10 11 12 :MODE?
Example	CALC:EVM:MARK:MODE POS CALC:EVM:MARK:MODE?
Key Path	Marker
Mode	TD-SCDMA

Notes	<p>If the selected marker is Off, pressing Marker sets it to Normal and places it at the center of the screen on the trace determined by the Marker Trace rules. At the same time, Marker X Axis Value appears on the Active Function area.</p> <p>Default Active Function: the active function for the selected marker's current control mode. If the current control mode is Off, there is no active function and the active function is turned off.</p> <p>Active Function Display: Marker X-axis value</p> <p>the marker X axis value entered in the active function area will display the marker value to its full entered precision.</p> <p>NORMal is used by PSA, POSition is used by MXA</p>
Preset	=OFF
Preset	OFF
State Saved	Saved in instrument state.
Range	Normal Delta Off
Test MIN/MAX/DEF	Yes
Instrument S/W Revision	A.01.60 or later

Marker Chip Value

Sets the marker Chip value in the current marker for the I/Q Polar, EVM, Mag Error and Phase Error trace. It has no effect if the control mode is Off, or the trace is not I/Q Polar, EVM, Mag Error and Phase Error, but if the control mode is Normal, this is the SCPI equivalent of entering a Chip value.

Remote Command	<pre>:CALCulate:EVM:MARKer [1] 2 3 4 5 6 7 8 9 10 11 12 :CHIP <real></pre> <pre>:CALCulate:EVM:MARKer [1] 2 3 4 5 6 7 8 9 10 11 12 :CHIP?</pre>
Example	<pre>CALC:EVM:MARK:CHIP 0</pre> <pre>CALC:EVM:MARK:CHIP?</pre>
Mode	TD-SCDMA
Notes	The query returns the marker's 'chips' value in the trace if the control mode is Normal . The query is returned in 'chips'. If the marker is Off the response is not a number (NAN).
Preset	0
Preset	0
State Saved	No
Min	-9.9E+37
Max	9.9E+37
Test MIN/MAX/DEF	No

Test UP/DOWN	10.0
Instrument S/W Revision	A.01.60 or later

Marker X Axis Value (Remote Command only)

Sets the marker X Axis value in the current marker X Axis Scale unit. It has no effect if the control mode is **Off**, but is the SCPI equivalent of entering an X value if the control mode is **Normal** or **Delta**.

Remote Command	:CALCulate:EVM:MARKer [1] 2 3 4 5 6 7 8 9 10 11 12 :X <real> :CALCulate:EVM:MARKer [1] 2 3 4 5 6 7 8 9 10 11 12 :X?
Example	CALC:EVM:MARK3:X 0.0 CALC:EVM:MARK3:X?
Mode	TD-SCDMA
Notes	The marker X Axis value has no unit suffix. For capture time data trace, the unit is second. The query returns the marker's absolute X Axis value if the control mode is Normal , or the offset from the marker's reference marker if the control mode is Delta . The query is returned without unit suffix.
Preset	0
Preset	After a preset, all Markers are turned OFF, so Marker X Axis Value query will return a not a number (NAN).
State Saved	No
Min	ñ9.9E+37
Max	9.9E+37
Test MIN/MAX/DEF	MIN MAX
Test UP/DOWN	Not tested in SCPI test but it is supported.
Instrument S/W Revision	A.01.60 or later

Marker X Axis Position (Remote Command only)

Sets the marker X position in trace points. It has no effect if the control mode is **Off**, but is the SCPI equivalent of entering a value if the control mode is **Normal** or **Delta** - except in trace points rather than X Axis Scale units. The entered value is immediately translated into the current X Axis Scale units for setting the value of the marker.

Remote Command	:CALCulate:EVM:MARKer [1] 2 3 4 5 6 7 8 9 10 11 12 :X: POS ition <real> :CALCulate:EVM:MARKer [1] 2 3 4 5 6 7 8 9 10 11 12 :X: POS ition?
-----------------------	--

Example	CALC:EVM:MARK10:X:POS 0.0 CALC:EVM:MARK10:X:POS?
Mode	TD-SCDMA
Preset	0
Preset	After a preset, all Markers are turned OFF, so Marker X Axis Value query will return a not a number (NAN).
State Saved	No
Min	ñ9.9E+37
Max	9.9E+37
Test MIN/MAX/DEF	MIN MAX
Test UP/DOWN	Not tested in SCPI test.
Instrument S/W Revision	A.01.60 or later

Marker Y Axis Value (Remote Command only)

Queries the marker Y Axis value in the current marker Y Axis unit.

Remote Command	:CALCulate:EVM:MARKer [1] 2 3 4 5 6 7 8 9 10 11 12 :Y?
Example	CALC:EVM:MARK11:Y?
Mode	TD-SCDMA
Preset	Result dependant on markers setup and signal source
State Saved	No
Test MIN/MAX/DEF	No
Instrument S/W Revision	A.01.60 or later

Properties

Accesses a menu that enables you to select a relative maker and marker trace

Key Path	Marker
Instrument S/W Revision	A.01.60 or later

Select Marker

Accesses a menu that enables you to select, set up and control the markers for the current measurement.

Key Path	Marker, Properties
Instrument S/W Revision	A.01.60 or later

Relative To

Selects the marker the selected marker will be relative to (its reference marker).

Remote Command	:CALCulate:EVM:MARKer [1] 2 3 4 5 6 7 8 9 10 11 12 :REFerence <integer> :CALCulate:EVM:MARKer [1] 2 3 4 5 6 7 8 9 10 11 12 :REFerence?
Example	CALC:EVM:MARK:REF 4 CALC:EVM:MARK:REF?
Key Path	Marker, Properties
Mode	TD-SCDMA
Notes	When queried a single value will be returned (the specified marker numbers relative marker). A marker cannot be relative to itself so that choice is grayed out, and if sent from SCPI generates error -221: "Settings conflict; marker cannot be relative to itself."
Preset	2 3 4 5 6 7 8 9 10 11 12 1
State Saved	Saved in instrument state.
Min	1
Max	12
Test MIN/MAX/DEF	Yes
Test UP/DOWN	1
Instrument S/W Revision	A.01.60 or later

Marker Trace

Assigns the specified marker to the designated trace.

Remote Command	:CALCulate:EVM:MARKer [1] 2 3 4 5 6 7 8 9 10 11 12 :TRACe POLar MERRor PERRor EVM CDPower CAPTime :CALCulate:EVM:MARKer [1] 2 3 4 5 6 7 8 9 10 11 12 :TRACe ?
Example	CALC:EVM:MARK:TRACE EVM CALC:EVM:MARK:TRACE?
Key Path	Marker, Properties
Mode	TD-SCDMA
Preset	EVM
State Saved	Saved in instrument state.

Range	Polar Mag Error Phase Error EVM Code Domain Power Capture Time
Test MIN/MAX/DEF	Yes
Instrument S/W Revision	A.01.60 or later

Couple Marker

Toggles the state of the markers to be coupled On or Off. When this function is true (On), moving any marker causes an equal X-axis movement of every other marker except those located to the polar trace, and Chip value of the marker located to the polar trace, which is not **Off**. “Equal X Axis movement” refers to the difference between each marker’s X Axis value (in the fundamental x-axis units of the trace that marker is on) and the X Axis value of the marker being moved (in the same fundamental x-axis units). This may result in markers going offscreen

Remote Command	:CALCulate:EVM:MARKer:COUple[:STATE] ON OFF 1 0 :CALCulate:EVM:MARKer:COUple[:STATE]?
Example	CALC:EVM:MARK:COUP ON CALC:EVM:MARK:COUP?
Key Path	Marker
Mode	TD-SCDMA
Preset	OFF
State Saved	Saved in instrument state.
Range	On Off
Test MIN/MAX/DEF	Yes
Instrument S/W Revision	A.01.60 or later

All Markers Off

Turns off all markers.

Remote Command	:CALCulate:EVM:MARKer:AOFF
Example	CALC:EVM:MARK:AOFF
Key Path	Marker
Mode	TD-SCDMA
Instrument S/W Revision	A.01.60 or later

Backward Compatibility SCPI Commands

Sets or queries the state of a marker. Setting a marker which is OFF to state ON or 1 puts it in Normal

Modulation Accuracy (Composite EVM) Measurement
Marker

mode and places it at the center of the screen.

Mode	TD-SCDMA
Remote Command	:CALCulate:EVM:MARKer [1] 2 3 4 5 6 7 8 9 10 11 12 :STATe OFF ON 0 1 :CALCulate:EVM:MARKer [1] 2 3 4 5 6 7 8 9 10 11 12 :STATe ?
Preset	OFF
State Saved	Saved in instrument state.
Range	On Off
Example	CALC:EVM:MARK3:STATe ON CALC:EVM:MARK3:STAT?
Instrument S/W Revision	A.01.60 or later

Marker Fctn

There are no Marker Function operations supported in the Modulation Accuracy measurement. The front-panel key will display a blank menu when pressed.

Key Path	Front panel key
Instrument S/W Revision	A.01.60 or later

Marker To

There are no Marker To operations supported in the Modulation Accuracy measurement. The front-panel key will display a blank menu when pressed.

Key Path	Front panel key
Instrument S/W Revision	A.01.60 or later

Meas

Operation of this key is identical across several measurements. For details about this key, see [“Meas” on page 1127](#) in the "Common Measurement Functions".

Meas Setup

This key displays the measurement setup menu for the Modulation Accuracy measurement when the Modulation Accuracy measurement is selected in the Measure menu.

Key Path	Front panel key
Instrument S/W Revision	A.01.60 or later

Avg/Hold Num

This key sets the number that will be averaged. After the specified number (average counts) have been averaged, the averaging mode (termination control) setting determines the averaging action.

Remote Command	<code>[:SENSe] :EVM:AVERage:COUNT <integer></code> <code>[:SENSe] :EVM:AVERage:COUNT?</code> <code>[:SENSe] :EVM:AVERage [:STATe] OFF ON 0 1</code> <code>[:SENSe] :EVM:AVERage [:STATe] ?</code>
-----------------------	--

Example	<code>EVM:AVER:COUN 100</code> <code>EVM:AVER:COUN?</code> <code>EVM:AVER OFF</code> <code>EVM:AVER?</code>
---------	--

Key Path	Meas Setup
Mode	TD-SCDMA
Preset	25 ON
State Saved	Saved in instrument state.
Min	1
Max	8192
Test MIN/MAX/DEF	Yes
Test UP/DOWN	10
Instrument S/W Revision	A.01.60 or later

Avg Mode

This key selects the type of termination control used for the averaging function. This determines the averaging action after the specified number of data acquisitions (average count) is reached. You can select between the Exp (exponential) and Repeat averaging modes. This selection only affects the averaging result after the number of N averages is reached. You can use the Avg/Hold Num key to set N.

KEYExponential averaging SCPIEXPonential	When Measure is set at Cont, data acquisitions will continue indefinitely. After N averages, exponential averaging is used with a weighting factor of N (the displayed average count stops at N). Exponential averaging weights new data more than old data, which allows tracking of slow-changing signals.
KEYRepeat averaging SCPIREPeat	When Measure is set at Cont, data acquisitions will continue indefinitely. After N averages is reached, all previous result data is cleared and the average count is set back to 1. This is equivalent to being in Measure Single and pressing the Restart key when the Single measurement finishes.
Remote Command	[:SENSe] :EVM:AVErAge:TCONtrol EXPonential REPeat [:SENSe] :EVM:AVErAge:TCONtrol?
Example	EVM:AVER:TCON EXP EVM:AVER:TCON?
Key Path	Meas Setup
Mode	TD-SCDMA
Preset	EXPonential
State Saved	Saved in instrument state.
Range	Exp Repeat
Instrument S/W Revision	A.01.60 or later

Result Length

Sets the result length in terms of sub-frames. It is the number of sub-frame user intends to analyze. For example, when it is necessary to estimate the S1/S2 phase on DwPTS, Result Length should be set to a number no less than 4.

Remote Command	[:SENSe] :EVM:RINTerval <integer> [:SENSe] :EVM:RINTerval?
Example	:EVM:RINT 1 :EVM:RINT?
Key Path	Meas Setup
Mode	TD-SCDMA
Preset	1
State Saved	Saved in instrument state.
Min	1

Modulation Accuracy (Composite EVM) Measurement Meas Setup

Max	12
Test MIN/MAX/DEF	Yes
Instrument S/W Revision	A.01.60 or later

Analysis Subframe

Specifies which sub-frame, within the acquired Result Length, is used for analysis and trace data measurement results. The available selections should include the acquired sub-frames.

Remote Command	<code>[:SENSe] :EVM:ANALysis:SUBFrame <integer></code> <code>[:SENSe] :EVM:ANALysis:SUBFrame?</code>
-----------------------	---

Dependencies/Couplings	Coupling with the Result Length. Analysis Subframe should be less than Result Length. IF(Analysis Subframe >= Result Length) Analysis Subframe = (Result Length – 1); ENDIF
------------------------	---

Example	<code>:EVM:ANAL:SUBF 0</code> <code>:EVM:ANAL:SUBF?</code>
---------	---

Key Path	Meas Setup
Mode	TD-SCDMA
Preset	0
State Saved	Saved in instrument state.
Min	0
Max	See Coupling
Test MIN/MAX/DEF	Yes
Test UP/DOWN	1
Instrument S/W Revision	A.01.60 or later

Limits

It allows you to set the limit lines which determine the Pass/Fail status of the specified results.

Key Path	Meas Setup
Instrument S/W Revision	A.01.60 or later

RMS EVM (Composite)

This key allows you to set the limit of composite RMS EVM measurement result. The default RMS

EVM limit for BTS is 12.5%, which is defined in 3GPP TS 25.142, 6.8.1. The default RMS EVM limit for MS is 17.5%, which is defined in 3GPP TS34.122, 5.7.1. When the average RMS EVM result exceeds the limit, a red FAIL indicator appears in the PASS/FAIL window. When the average RMS EVM result is less than the limit, a green PASS indicator appears in the PASS/FAIL window.

Remote Command	:CALCulate:EVM:LIMit [1] 2:RMS <real> :CALCulate:EVM:LIMit [1] 2:RMS?
Dependencies/Couplings	Coupling with Mode Setup, Radio, Device: If BTS is selected, the default value is 12.5; If MS is selected, the default value is 17.5.
Example	:CALC:EVM:LIM1:RMS 1.0 :CALC:EVM:LIM1:RMS?
Key Path	Meas Setup, Limits
Mode	TD-SCDMA
Notes	LIMit[1]: BTS RMS EVM LIMit2: MS RMS EVM
Preset	12.5 17.5
State Saved	Saved in instrument state.
Min	0.0
Max	100.0
Test MIN/MAX/DEF	Yes
Test UP/DOWN	1
Instrument S/W Revision	A.01.60 or later

Peak EVM (Composite)

This key allows you to set the limit for composite peak EVM measurement result.

Remote Command	:CALCulate:EVM:LIMit [1] 2:PEAK <real> :CALCulate:EVM:LIMit [1] 2:PEAK?
Example	:CALC:EVM:LIM1:PEAK 100.0 :CALC:EVM:LIM1:PEAK?
Key Path	Meas Setup, Limits
Mode	TD-SCDMA
Notes	LIMit[1]: BTS Peak EVM LIMit2: MS Peak EVM

Modulation Accuracy (Composite EVM) Measurement Meas Setup

Preset	200.0
State Saved	Saved in instrument state.
Min	0.0
Max	200.0
Test MIN/MAX/DEF	Yes
Test UP/DOWN	1
Instrument S/W Revision	A.01.60 or later

Rho (Composite)

This key allows you to set the limit for composite Rho measurement result.

Remote Command	:CALCulate:EVM:LIMit [1] 2:RHO <real> :CALCulate:EVM:LIMit [1] 2:RHO?
Example	:CALC:EVM:LIM1:RHO 0.9 :CALC:EVM:LIM1:RHO?
Key Path	Meas Setup, Limits
Mode	TD-SCDMA
Notes	LIMit[1]: BTS Rho LIMit2: MS Rho
Preset	0.50000
State Saved	Saved in instrument state.
Min	0.0
Max	1.0
Test MIN/MAX/DEF	Yes
Test UP/DOWN	0.0001
Instrument S/W Revision	A.01.60 or later

Peak Code Domain Error

This key allows you to set the Peak Code Domain Error limit in dB. The default value for BTS is –28 dB, which is defined in 3GPP TS25.142, 6.8.2. The default value for MS is –21.0 dB, which is defined in 3GPP TS34.122, 5.7.2.

Remote Command	:CALCulate:EVM:LIMit [1] 2:PCDE <rel_amp1> :CALCulate:EVM:LIMit [1] 2:PCDE?
-----------------------	--

Dependencies/Couplings	Coupling with Mode Setup, Radio, Device: If BTS is selected, the default value is -28.0; If MS is selected, the default value is -21.0
Example	:CALC:EVM:LIM1:PCDE -10.0 dB :CALC:EVM:LIM1:PCDE?
Key Path	Meas Setup, Limits
Mode	TD-SCDMA
Notes	LIMit[1]: BTS Peak CDE LIMit2: MS Peak CDE
Preset	-28.0 -21.0
State Saved	Saved in instrument state.
Min	-100.0
Max	0.0
Test MIN/MAX/DEF	Yes
Test UP/DOWN	1
Instrument S/W Revision	A.01.60 or later

Frequency Error

This key sets a frequency error limit to warn you if the measured average frequency error value exceeds a limit. The default value for BTS is 0.05ppm (relative to carrier frequency) defined in 3GPP TS25.142, 6.3.2. The default value for MS is 0.1ppm (relative to carrier frequency) defined in 3GPP TS34.122, 5.3.2.

Remote Command	:CALCulate:EVM:LIMit [1] 2:FERRor <real> :CALCulate:EVM:LIMit [1] 2:FERRor?
Dependencies/Couplings	Coupling with Mode Setup, Radio, Device: If BTS is selected, the default value is 0.05; If MS is selected, the default value is 0.1.
Example	:CALC:EVM:LIM1:FERR 0.005 :CALC:EVM:LIM1:FERR?
Key Path	Meas Setup, Limits
Mode	TD-SCDMA
Notes	LIMit[1]: BTS Frequency Error LIMit2: MS Frequency Error
Preset	0.050 0.100

Modulation Accuracy (Composite EVM) Measurement **Meas Setup**

State Saved	Saved in instrument state.
Min	0.000
Max	2.000
Test MIN/MAX/DEF	Yes
Test UP/DOWN	0.01
Instrument S/W Revision	A.01.60 or later

Meas Preset

This key allows users to restore all the measurement settings to their defaults.

This will set the measure setup parameters for the currently selected measurement only, to the factory defaults.

Remote Command	:CONFigure:EVM
Dependencies/Couplings	Selecting measurement preset will restore all measurement parameters to their default values for the current measurement.
Example	:CONFigure:EVM
Key Path	Meas Setup
Mode	TD-SCDMA
Instrument S/W Revision	A.01.60 or later

Mode

Operation of this key is identical across several measurements. For details about this key, see “[Mode](#)” on [page 1145](#) in the “Common Measurement Functions”.

Mode Setup

Operation of this key is identical across several measurements. For details about this key, see Mode Setup “[Mode Setup](#)” on page 1159 for more information.

Peak Search

Accesses a menu that enables you to control the peak search function and places a marker on the trace point with highest peak.

Peak Search

Places the selected marker on the trace point with the maximum y-axis value for that marker's trace.

Remote Command	:CALCulate:EVM:MARKer [1] 2 3 4 5 6 7 8 9 10 11 12:MAXimum
Example	CALC:EVM:MARK2:MAX
Key Path	Front panel key
Mode	TD-SCDMA
Instrument S/W Revision	A.01.60 or later

Next Peak

Moves the selected marker to the peak that has the next highest amplitude less than the marker's current value.

Remote Command	:CALCulate:EVM:MARKer [1] 2 3 4 5 6 7 8 9 10 11 12:MAXimum:NEXT
Example	CALC:EVM:MARK2:MAX:NEXT
Key Path	Peak Search
Mode	TD-SCDMA
Instrument S/W Revision	A.01.60 or later

Next Pk Right

Moves the selected marker to the nearest peak right of the current marker which meets all enabled peak criteria.

Remote Command	:CALCulate:EVM:MARKer [1] 2 3 4 5 6 7 8 9 10 11 12:MAXimum:RIGHT
Example	CALC:EVM:MARK2:MAX:RIGH
Key Path	Peak Search
Mode	TD-SCDMA
Instrument S/W Revision	A.01.60 or later

Next Pk Left

Moves the selected marker to the nearest peak left of the current marker which meets all enabled peak criteria.

Remote Command	:CALCulate:EVM:MARKer [1] 2 3 4 5 6 7 8 9 10 11 12 :MAXimum:LEFT
Example	CALC:EVM:MARK2:MAX:LEFT
Key Path	Peak Search
Mode	TD-SCDMA
Instrument S/W Revision	A.01.60 or later

Marker Delta

Sets the control mode for the selected marker to **Delta** mode.

Key Path	Peak Search
Instrument S/W Revision	A.01.60 or later

Pk-Pk Search

Finds and displays the amplitude and frequency (or time, if in zero span) differences between the highest and lowest y-axis value.

Remote Command	:CALCulate:EVM:MARKer [1] 2 3 4 5 6 7 8 9 10 11 12 :PTPeak
Dependencies/Couplings	This key is not available (key is grayed out) when Coupled Markers is on.
Example	CALC:EVM:MARK:PTP
Key Path	Peak Search
Mode	TD-SCDMA
Notes	Turns on the Marker Δ active function.
Instrument S/W Revision	A.01.60 or later

Min Search

Moves the selected marker to the minimum y-axis value on the current trace.

Remote Command	:CALCulate:EVM:MARKer [1] 2 3 4 5 6 7 8 9 10 11 12 :MINimum
Example	CALC:EVM:MARK:MIN
Key Path	Peak Search

Mode	TD-SCDMA
Instrument S/W Revision	A.01.60 or later

Source

There is no source functionality in the Modulation Accuracy measurement.

Key Path	Front-panel key
Instrument S/W Revision	A.01.60 or later

SPAN X Scale

The SPAN X Scale key accesses the menu to set the desired horizon scale and associated settings of window.

It specifies SPAN X Scale setting when EVM, Magnitude Error, Phase Error, Code Domain Power, or Capture Time Data Trace Window is active.

Key Path	Front panel key
Instrument S/W Revision	A.01.60 or later

Ref Value

This key allows you to set the display X reference value. The key is active in EVM Window, Magnitude Error Window, Phase Error Window, Code Domain Power Window, and Capture Time Data Trace Window.

Key Path	Span X Scale
Instrument S/W Revision	A.01.60 or later

X Ref Value (I/Q Error View – Magnitude Error Window)

This key sets the chip reference value on the horizontal axis in the Magnitude Error window.

Remote Command	:DISPlay:EVM:VIEW2:WINDow[1]:TRACe:X[:SCALE]:RLEVel <real> :DISPlay:EVM:VIEW2:WINDow[1]:TRACe:X[:SCALE]:RLEVel?
Dependencies/Couplings	See Notes
Example	DISP:EVM:VIEW2:WIND:TRAC:X:RLEV 0.0 DISP:EVM:VIEW2:WIND:TRAC:X:RLEV?
Key Path	Span X Scale
Mode	TD-SCDMA
Notes	VIEW2 : I/Q Error View WINDow[1]: Mag Error Window on I/Q Error View If Auto Scale is set to On, this value is automatically determined by the measurement result. When you set this value manually, Auto Scale is automatically set to Off.
Preset	0
State Saved	Saved in instrument state.
Min	0

Modulation Accuracy (Composite EVM) Measurement
SPAN X Scale

Max	1000
Test MIN/MAX/DEF	Yes
Test UP/DOWN	1, 2, 5, 10
Instrument S/W Revision	A.01.60 or later

X Ref Value (I/Q Error View – Phase Error Window)

This key sets the chip reference value on the horizontal axis in the phase error window.

Remote Command	:DISPlay:EVM:VIEW2:WINDow2:TRACe:X[:SCALe]:RLEVel <real> :DISPlay:EVM:VIEW2:WINDow2:TRACe:X[:SCALe]:RLEVel?
Dependencies/Couplings	See Notes
Example	DISP:EVM:VIEW2:WIND2:TRAC:X:RLEV 0.0 DISP:EVM:VIEW2:WIND2:TRAC:X:RLEV?
Key Path	Span X Scale
Mode	TD-SCDMA
Notes	VIEW2 : I/Q Error View WINDow2: Phase Error Window on I/Q Error View If Auto Scale is set to On, this value is automatically determined by the measurement result. When you set this value manually, Auto Scale is automatically set to Off.
Preset	0
State Saved	Saved in instrument state.
Min	0
Max	1000
Test MIN/MAX/DEF	Yes
Test UP/DOWN	1, 2, 5, 10
Instrument S/W Revision	A.01.60 or later

X Ref Value (I/Q Error View – EVM Window)

This key sets the chip reference value on the horizontal axis in the EVM Window.

Remote Command	:DISPlay:EVM:VIEW2:WINDow3:TRACe:X[:SCALe]:RLEVel <real> :DISPlay:EVM:VIEW2:WINDow3:TRACe:X[:SCALe]:RLEVel?
Dependencies/Couplings	See Notes

Example	DISP:EVM:VIEW2:WIND3:TRAC:X:RLEV 0.0 DISP:EVM:VIEW2:WIND3:TRAC:X:RLEV?
Key Path	Span X Scale
Mode	TD-SCDMA
Notes	VIEW2 : I/Q Error View WINDow3: EVM Window on I/Q Error View If Auto Scale is set to On, this value is automatically determined by the measurement result. When you set this value manually, Auto Scale is automatically set to Off.
Preset	0
State Saved	Saved in instrument state.
Min	0
Max	1000
Test MIN/MAX/DEF	Yes
Test UP/DOWN	1, 2, 5, 10
Instrument S/W Revision	A.01.60 or later

X Ref Value (Code Domain Power and Metrics View – Code Domain Power Window)

This key sets the code reference value on the horizontal axis in the Code Domain Power window.

Remote Command	:DISPlay:EVM:VIEW3:WINDow[1]:TRACe:X[:SCALE]:RLEVel <integer> :DISPlay:EVM:VIEW3:WINDow[1]:TRACe:X[:SCALE]:RLEVel?
Example	DISP:EVM:VIEW3:WIND:TRAC:X:RLEV 0 DISP:EVM:VIEW3:WIND:TRAC:X:RLEV?
Key Path	Span X Scale
Mode	TD-SCDMA
Notes	VIEW3 : Code Domain Power and Metrics View WINDow[1]: Code Domain Power and Metrics Window on Code Domain Power View
Preset	0
State Saved	Saved in instrument state.
Min	0
Max	16
Test MIN/MAX/DEF	Yes

Modulation Accuracy (Composite EVM) Measurement
SPAN X Scale

Test UP/DOWN	5
Instrument S/W Revision	A.01.60 or later

X Ref Value (Capture Time Summary View – Capture Time Data Trace Window)

This key sets the time reference value on the horizontal axis in the Capture Time Data Trace window.

Remote Command	:DISPlay:EVM:VIEW4:WINDow[1]:TRACe:X[:SCALe]:RLEVel <time> :DISPlay:EVM:VIEW4:WINDow[1]:TRACe:X[:SCALe]:RLEVel?
Dependencies/Couplings	See Notes
Example	DISP:EVM:VIEW4:WIND:TRAC:X:RLEV 0.0 ms DISP:EVM:VIEW4:WIND:TRAC:X:RLEV?
Key Path	Span X Scale
Mode	TD-SCDMA
Notes	VIEW4 : Capture Time Summary View WINDow[1]: Capture Time Data Trace Window on Capture Time Summary View If Auto Scale is set to On, this value is automatically determined by the measurement result. When you set this value manually, Auto Scale is automatically set to Off.
Preset	0.000 s
State Saved	Saved in instrument state.
Min	0.000 s
Max	60.0 ms
Test MIN/MAX/DEF	Yes
Test UP/DOWN	1, 2, 5, 10
Instrument S/W Revision	A.01.60 or later

Scale/Div

Following is for X Scale/Div control. The key is active in EVM Window, Magnitude Error Window, Phase Error Window, Code Domain Power Window, and Capture Time Data Trace Window.

Key Path	Span X Scale
Instrument S/W Revision	A.01.60 or later

X Scale/Div (I/Q Error View – Magnitude Error Window)

This key sets the horizontal scale by changing a chip value per division in the Magnitude Error window.

Remote Command	:DISPlay:EVM:VIEW2:WINDow[1]:TRACe:X[:SCALE]:PDIVision <real> :DISPlay:EVM:VIEW2:WINDow[1]:TRACe:X[:SCALE]:PDIVision?
Dependencies/Couplings	See Notes
Example	DISP:EVM:VIEW2:WIND:TRAC:X:PDIV 100.0 DISP:EVM:VIEW2:WIND:TRAC:X:PDIV?
Key Path	Span X Scale
Mode	TD-SCDMA
Notes	VIEW2 : I/Q Error View WINDow[1]: Magnitude Error Window on I/Q Error View If Auto Scale is set to On, this value is automatically determined by the measurement result. When you set this value manually, Auto Scale is automatically set to Off.
Preset	84.8
State Saved	Saved in instrument state.
Min	0.1
Max	1000.0
Test MIN/MAX/DEF	Yes
Test UP/DOWN	1, 2, 5, 10
Instrument S/W Revision	A.01.60 or later

X Scale/Div (I/Q Error View – Phase Error Window)

This key sets the horizontal scale by changing a chip value per division in the phase error window.

Remote Command	:DISPlay:EVM:VIEW2:WINDow2:TRACe:X[:SCALE]:PDIVision <real> :DISPlay:EVM:VIEW2:WINDow2:TRACe:X[:SCALE]:PDIVision?
Dependencies/Couplings	See Notes
Example	DISP:EVM:VIEW2:WIND2:TRAC:X:PDIV 100.0 DISP:EVM:VIEW2:WIND2:TRAC:X:PDIV?
Key Path	Span X Scale
Mode	TD-SCDMA

Modulation Accuracy (Composite EVM) Measurement
SPAN X Scale

Notes	VIEW2 : I/Q Error View WINDow2: Phase Error Window on I/Q Error View If Auto Scale is set to On, this value is automatically determined by the measurement result. When you set this value manually, Auto Scale is automatically set to Off.
Preset	84.8
State Saved	Saved in instrument state.
Min	0.1
Max	1000.0
Test MIN/MAX/DEF	Yes
Test UP/DOWN	1, 2, 5, 10
Instrument S/W Revision	A.01.60 or later

X Scale/Div (I/Q Error View – EVM Window)

This key sets the horizontal scale by changing a chip value per division in EVM window.

Remote Command	:DISPlay:EVM:VIEW2:WINDow3:TRACe:X[:SCALe]:PDIVision <real> :DISPlay:EVM:VIEW2:WINDow3:TRACe:X[:SCALe]:PDIVision?
Dependencies/Couplings	See Notes
Example	DISP:EVM:VIEW2:WIND3:TRAC:X:PDIV 100.0 DISP:EVM:VIEW2:WIND3:TRAC:X:PDIV?
Key Path	Span X Scale
Mode	TD-SCDMA
Notes	VIEW2 : I/Q Error View WINDow3: EVM Window on I/Q Error View If Auto Scale is set to On, this value is automatically determined by the measurement result. When you set this value manually, Auto Scale is automatically set to Off.
Preset	84.8
State Saved	Saved in instrument state.
Min	0.1
Max	1000.0
Test MIN/MAX/DEF	Yes
Test UP/DOWN	1, 2, 5, 10

Instrument S/W Revision A.01.60 or later

X Scale/Div (Code Domain Power and Metrics View – Code Domain Power Window)

This key sets the horizontal scale by changing a code value per division in the Code Domain Power window.

Remote Command	:DISPlay:EVM:VIEW3:WINDow[1]:TRACe:X[:SCALe]:PDIVision <Integer> :DISPlay:EVM:VIEW3:WINDow[1]:TRACe:X[:SCALe]:PDIVision?
Example	DISP:EVM:VIEW3:WIND:TRAC:X:PDIV 16 DISP:EVM:VIEW3:WIND:TRAC:X:PDIV?
Key Path	Span X Scale
Mode	TD-SCDMA
Notes	VIEW3 : Code Domain Power and Metrics View WINDow[1]: Code Domain Power Window on Code Domain Power and Metrics View
Preset	16
State Saved	Saved in instrument state.
Min	1
Max	16
Test MIN/MAX/DEF	Yes
Test UP/DOWN	5
Instrument S/W Revision	A.01.60 or later

X Scale/Div (Capture Time Summary View – Capture Time Data Trace Window)

This key sets the horizontal scale by changing a time value per division in Capture Time Data Trace window.

Remote Command	:DISPlay:EVM:VIEW4:WINDow[1]:TRACe:X[:SCALe]:PDIVision <time> :DISPlay:EVM:VIEW4:WINDow[1]:TRACe:X[:SCALe]:PDIVision?
Dependencies/Couplings	See Notes
Example	DISP:EVM:VIEW4:WIND:TRAC:X:PDIV 1.0 ms DISP:EVM:VIEW4:WIND:TRAC:X:PDIV?
Key Path	Span X Scale
Mode	TD-SCDMA

Modulation Accuracy (Composite EVM) Measurement
SPAN X Scale

Notes	VIEW4 : Capture Time Summary View WINDow[1]: Capture Time Data Trace Window on Capture Time Summary View If Auto Scale is set to On, this value is automatically determined by the measurement result. When you set this value manually, Auto Scale is automatically set to Off.
Preset	100.0 us
State Saved	Saved in instrument state.
Min	100.0 us
Max	10 ms
Test MIN/MAX/DEF	Yes
Test UP/DOWN	1, 2, 5, 10
Instrument S/W Revision	A.01.60 or later

Ref Position

This key allows you to set the display reference position to either Left, Ctr (center), or Right. The key is active in EVM Window, Mag Error Window, Phase Error Window, Code Domain Power Window, and Capture Time Data Trace Window.

Key Path	Span X Scale
Instrument S/W Revision	A.01.60 or later

X Ref Position (I/Q Error View – Magnitude Error Window)

This key sets the X axis reference position in the Magnitude Error window.

Remote Command	:DISPlay:EVM:VIEW2:WINDow [1] :TRACe:X[:SCALe]:RPOSition LEFT CENTer RIGHT :DISPlay:EVM:VIEW2:WINDow [1] :TRACe:X[:SCALe]:RPOSition?
Example	DISP:EVM:VIEW2:WIND:TRAC:X:RPOS LEFT DISP:EVM:VIEW2:WIND:TRAC:X:RPOS?
Key Path	Span X Scale
Mode	TD-SCDMA
Notes	VIEW2 : I/Q Error View WINDow[1]: Mag Error Window on I/Q Error View
Preset	LEFT
State Saved	Saved in instrument state.

Range Left|Ctr|Right
Instrument S/W Revision A.01.60 or later

X Ref Position (I/Q Error View – Phase Error Window)

This key sets the X axis reference position in the phase error window.

Remote Command :DISPlay:EVM:VIEW2:WINDow2:TRACe:X[:SCALE]:RPOStion
LEFT|CENTer|RIGHT
:DISPlay:EVM:VIEW2:WINDow2:TRACe:X[:SCALE]:RPOStion?

Example DISP:EVM:VIEW2:WIND2:TRAC:X:RPOS LEFT
DISP:EVM:VIEW2:WIND2:TRAC:X:RPOS?

Key Path **Span X Scale**

Mode TD-SCDMA

Notes VIEW2 : I/Q Error View
WINDow2: Phase Error Window on I/Q Error View

Preset LEFT

State Saved Saved in instrument state.

Range Left|Ctr|Right

Instrument S/W Revision A.01.60 or later

X Ref Position (I/Q Error View – EVM Window)

This key sets the X axis reference position in the EVM window.

Remote Command :DISPlay:EVM:VIEW2:WINDow3:TRACe:X[:SCALE]:RPOStion
LEFT|CENTer|RIGHT
:DISPlay:EVM:VIEW2:WINDow3:TRACe:X[:SCALE]:RPOStion?

Example DISP:EVM:VIEW2:WIND3:TRAC:X:RPOS LEFT
DISP:EVM:VIEW2:WIND3:TRAC:X:RPOS?

Key Path **Span X Scale**

Mode TD-SCDMA

Notes VIEW2 : I/Q Error View
WINDow3: EVM Window on I/Q Error View

Preset LEFT

State Saved Saved in instrument state.

Range Left|Ctr|Right

Modulation Accuracy (Composite EVM) Measurement SPAN X Scale

Instrument S/W Revision A.01.60 or later

X Ref Position (Code Domain Power and Metrics View – Code Domain Power Window)

This key sets the X axis reference position in the Code Domain Power window.

Remote Command	<code>:DISPlay:EVM:VIEW3:WINDow[1]:TRACe:X[:SCALe]:RPOSition LEFT CENTer RIGHT</code> <code>:DISPlay:EVM:VIEW3:WINDow[1]:TRACe:X[:SCALe]:RPOSition?</code>
Example	<code>DISP:EVM:VIEW3:WIND:TRAC:X:RPOS LEFT</code> <code>DISP:EVM:VIEW3:WIND:TRAC:X:RPOS?</code>
Key Path	Span X Scale
Mode	TD-SCDMA
Notes	VIEW3 : Code Domain Power and Metrics View WINDow[1]: Code Domain Power Window on Code Domain Power and Metrics View
Preset	LEFT
State Saved	Saved in instrument state.
Range	Left Ctr Right
Instrument S/W Revision	A.01.60 or later

X Ref Position (Capture Time Summary View – Capture Time Data Trace Window)

This key sets the X axis reference position in the Capture Time Data Trace window.

Remote Command	<code>:DISPlay:EVM:VIEW4:WINDow[1]:TRACe:X[:SCALe]:RPOSition LEFT CENTer RIGHT</code> <code>:DISPlay:EVM:VIEW4:WINDow[1]:TRACe:X[:SCALe]:RPOSition?</code>
Example	<code>DISP:EVM:VIEW4:WIND:TRAC:X:RPOS LEFT</code> <code>DISP:EVM:VIEW4:WIND:TRAC:X:RPOS?</code>
Key Path	Span X Scale
Mode	TD-SCDMA
Notes	VIEW4 : Capture Time Summary View WINDow[1]: Capture Time Data Trace Window on Capture Time Summary View
Preset	LEFT
State Saved	Saved in instrument state.
Range	Left Ctr Right

Modulation Accuracy (Composite EVM) Measurement
SPAN X Scale

value results in the Phase Error window.

Remote Command	:DISPlay:EVM:VIEW2:WINDow2:TRACe:X[:SCALe]:COUPle 0 1 OFF ON :DISPlay:EVM:VIEW2:WINDow2:TRACe:X[:SCALe]:COUPle?
Dependencies/Couplings	See Notes
Example	DISP:EVM:VIEW2:WIND2:TRAC:X:COUP ON DISP:EVM:VIEW2:WIND2:TRAC:X:COUP?
Key Path	Span X Scale
Mode	TD-SCDMA
Notes	VIEW2 : I/Q Error View WINDow2: Phase Error Window on I/Q Error View When this parameter is set to On, it will activate the scale coupling function that automatically determines scale per division and reference values based on the measurement results. When you set a value to either Scale/Div or Ref Value manually, Auto Scale is automatically set to Off.
Preset	ON
State Saved	Saved in instrument state.
Range	On Off
Instrument S/W Revision	A.01.60 or later

X Auto Scale (I/Q Error View – EVM Window)

When Auto Scale is On, it will result in automatically displaying the scale per division and reference value results in the EVM window.

Remote Command	:DISPlay:EVM:VIEW2:WINDow3:TRACe:X[:SCALe]:COUPle 0 1 OFF ON :DISPlay:EVM:VIEW2:WINDow3:TRACe:X[:SCALe]:COUPle?
Dependencies/Couplings	See Notes
Example	DISP:EVM:VIEW2:WIND3:TRAC:X:COUP ON DISP:EVM:VIEW2:WIND3:TRAC:X:COUP?
Key Path	Span X Scale
Mode	TD-SCDMA

Notes	VIEW2 : I/Q Error View WINDow3: EVM Window on I/Q Error View When this parameter is set to On, it will activate the scale coupling function that automatically determines scale per division and reference values based on the measurement results. When you set a value to either Scale/Div or Ref Value manually, Auto Scale is automatically set to Off.
Preset	ON
State Saved	Saved in instrument state.
Range	On Off
Instrument S/W Revision	A.01.60 or later

X Auto Scale (Capture Time Summary View – Capture Time Data Trace Window)

When Auto Scale is On, it will result in automatically displaying the scale per division and reference value results in the Capture Time Data Trace window.

Remote Command	:DISPlay:EVM:VIEW4:WINDow[1]:TRACe:X[:SCALE]:COUPle 0 1 OFF ON :DISPlay:EVM:VIEW4:WINDow[1]:TRACe:X[:SCALE]:COUPle?
Dependencies/Couplings	See Notes
Example	DISP:EVM:VIEW4:WIND:TRAC:X:COUP ON DISP:EVM:VIEW4:WIND:TRAC:X:COUP?
Key Path	Span X Scale
Mode	TD-SCDMA
Notes	VIEW4 : Capture Time Summary View WINDow[1]: Capture Time Data Trace Window on Capture Time Summary View When this parameter is set to On, it will activate the scale coupling function that automatically determines scale per division and reference values based on the measurement results. When you set a value to either Scale/Div or Ref Value manually, Auto Scale is automatically set to Off.
Preset	ON
State Saved	Saved in instrument state.
Range	On Off
Instrument S/W Revision	A.01.60 or later

Sweep/Control

Operation of this key is identical across several measurements. For details about this key, see [“Sweep / Control” on page 1235](#) in the "Common Measurement Functions".

NOTE Gate function is not supported in the Modulation Accuracy measurement.

Key Path	Front panel key
Instrument S/W Revision	A.01.60 or later

Abort (Remote Command Only)

See [“Abort \(Remote Command Only\)” on page 1235](#) in the section "Common Measurement Functions" for more information.

Pause and Resume

See [“Pause/Resume” on page 1236](#) in the section "Common Measurement Functions" for more information.

Record Data Now

See [“Pause/Resume” on page 1236](#) in the section "Common Measurement Functions" for more information.

Playback (Recorded Data)

See Playback (Recorded Data) in the section "Common Measurement Functions" for more information.

Trace/Detector

There is no trace/detector functionality supported in the Modulation Accuracy measurement.

Key Path	Front-panel key
Instrument S/W Revision	A.01.60 or later

Trigger

Trigger Source

Selects a trigger source for current measurement.

See also:

[RF Trigger Source](#)

[I/Q Trigger Source](#)

NOTE Trigger Source setup parameters are valid for the current measurement.

Remote Command	:TRIGger:EVM[:SEQuence]:SOURce EXTernal[1] EXTernal2 IMMediate RFBurst VIDeo IQMag IDEMod QDEMod IINPut QINPut AIQMag :TRIGger:EVM[:SEQuence]:SOURce?
Example	TRIG:EVM:SOUR RFB TRIG:EVM:SOUR?
Key Path	Trigger
Mode	TD-SCDMA
Notes	<ol style="list-style-type: none"> 1. Video and RF Burst are available only when in RF input and those selection menu keys are blank when in I/Q Input. 2. Baseband I/Q key is available only when in I/Q input, otherwise blank. IQMag, IDEMod, QDEMod, IINPut, QINPut and AIQMag are valid only when in I/Q input.
Preset	IMMediate
Preset	Varies with selected input (see RF Trigger Source and I/Q Trigger Source)
State Saved	Saved in instrument state.
Range	Free Run (Immediate) Video (IF Envlp) External 1 External 2 RF Burst (Wideband) I/Q Mag I (Demodulated) Q (Demodulated) Input I Input Q Auxiliary Channel I/Q Mag
Instrument S/W Revision	A.01.60 or later

RF Trigger Source

Specifies the Trigger Source for RF Input signals.

Remote Command	:TRIGger:EVM[:SEquence]:RF:SOURce IMMediate EXTErnal[1] EXTErnal2 RFBurst VIDeo :TRIGger:EVM[:SEquence]:RF:SOURce?
Example	TRIG:EVM:RF:SOUR RFB TRIG:EVM:RF:SOUR?
Key Path	Trigger
Mode	TD-SCDMA
Preset	IMMediate
State Saved	Saved in instrument state.
Range	Free Run (Immediate) Video (IF Envlp) External 1 External 2 RF Burst (Wideband)
Instrument S/W Revision	A.01.60 or later

I/Q Trigger Source

Specifies the Trigger Source for I/Q Input signals.

Remote Command	:TRIGger:EVM[:SEquence]:IQ:SOURce IMMediate EXTErnal[1] EXTErnal2 IQMag IDEMod QDEMod IINPut QINPut AIQMag :TRIGger:EVM[:SEquence]:IQ:SOURce?
Example	TRIG:EVM:SOUR IQMag TRIG:EVM:SOUR?
Key Path	Trigger
Mode	TD-SCDMA
Preset	IMMediate
State Saved	Saved in instrument state.
Range	Free Run (Immediate) External 1 External 2 I/Q Mag I (Demodulated) Q (Demodulated) Input I Input Q Auxiliary Channel I/Q Mag
Instrument S/W Revision	A.01.60 or later

Auto Trig

See “Auto Trig ” on page 1304 in the "Common Measurement Functions" for more information.

Trig Holdoff

See “[Trig Holdoff](#)” on page 1304 in the "Common Measurement Functions" for more information.

View/Display

The View/Display key opens up the View/Display menu for the current measurement. The views that are available are specific to the current measurement selected under the **Meas** key.

For more information, see [Modulation Accuracy Measurement Views and Results](#).

Key Path	Front panel key
Instrument S/W Revision	A.01.60 or later

Modulation Accuracy Measurement Views and Results

The Mod Accuracy measurement consists of five views. The default view is I/Q Measured Polar Graph (left/right).

No.	View	NO. of Windows	Window No.	Window
1	VIEW[1] View – I/Q Measured Polar Graph	Dual (Horizontal)	WINDow[1]	Result Metrics Window
			WINDow2	I/Q Measured Polar Vector Window
2	VIEW2 View - IQ Error	Quad	WINDow[1]	Magnitude Error Window
			WINDow2	Phase Error Window
			WINDow3	EVM Window
			WINDow4	Result Metrics Window
3	VIEW3 View – Code Domain Power	Dual (Vertical)	WINDow[1]	Code Domain Power Window
			WINDow2	Code Domain Power Summary Window
4	VIEW4 View – Capture Time Summary	Dual (Vertical)	WINDow[1]	Capture Time Data Trace Window
			WINDow2	Capture Time Summary Window
5	VIEW5 View – Numeric Results	Single	WINDow[1]	Numeric Results Summary Window

View – I/Q Measured Polar Graph

There are two windows: [Result Metrics Window](#) (left) and [I/Q Measured Polar Vector Window](#) (right).

Modulation Accuracy (Composite EVM) Measurement
View/Display

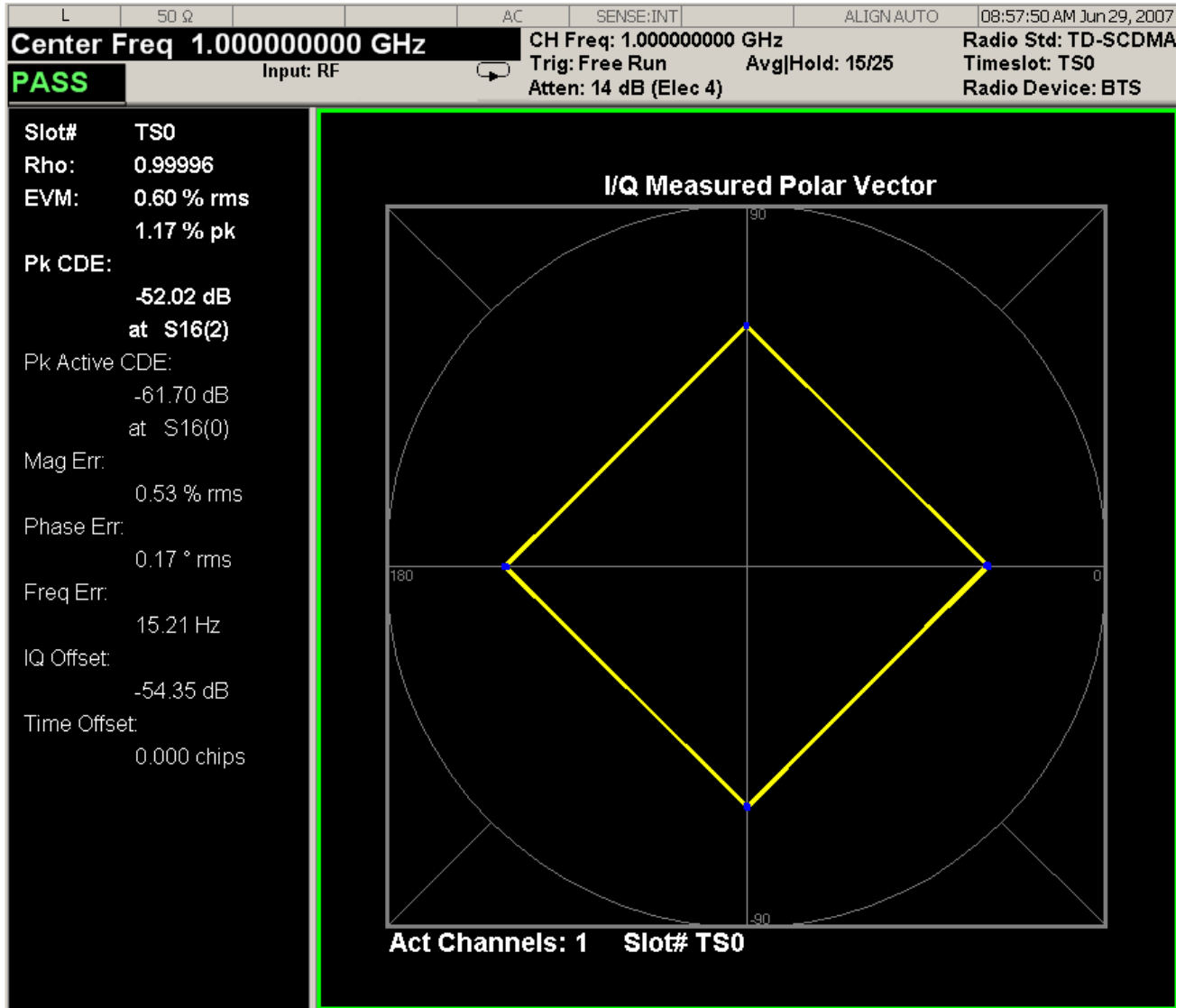

Result Metrics Window

Modulation Accuracy Result Metrics are listed in the following table.

Name	Corresponding Results	Format
Slot	Number of current timeslot which is under measurement	TSi, (i=0, 1, ..., 6) DwPTS UpPTS
Rho	n=1, 1st Averaged composite Rho (in average cycle) of the selected timeslot	9.9999

Name	Corresponding Results	Format
RMS EVM	n=1 3rd Averaged composite RMS EVM (in average cycle) of the selected timeslot	99.99 % rms
Pk EVM	n=1 6th Peak hold composite Peak EVM (in average cycle) of the selected timeslot	99.99 % pk
Pk CDE	n=1 16th Peak hold Peak Code Domain Error (of all the code channels, including active and inactive, in average cycle) of the selected timeslot	99.99 dB
Pk CDE Position	n=1 29th Code length of peak hold Peak CDE (in average cycle) of the selected timeslot, X of SX(Y); n=1 30th Code index of peak hold Peak CDE (in average cycle) of the selected timeslot, Y of SX(Y)	SX(Y) X: OVFSF code length (1,2,4,8,16) Y: OVFSF code index (0, ... X-1)
Pk Active CDE	n=1 18th Peak hold Peak Active CDE (of active code channels, in average cycle) of the selected timeslot	99.99 dB
Pk Active CDE Position	n=1 31st Code length of peak hold Peak Active CDE (in average cycle) of the selected timeslot, X of SX(Y); n=1 32nd Code index of peak hold Peak Active CDE (in average cycle) of the selected timeslot, Y of SX(Y)	SX(Y) X: OVFSF code length (1,2,4,8,16) Y: OVFSF code index (0, ... X-1)
RMS Mag Err	n=1 7th Averaged composite RMS Magnitude Error (in average cycle) of the selected timeslot	99.99 % rms
RMS Phase Err	n=1 11th Averged composite RMS Phase Error (in average cycle) of the selected timeslot	99.99 ° rms
Freq Err	n=1 19th Averaged composite Frequency Error (in average cycle) of the selected timeslot	99.99 Hz
IQ Offset	n=1 21st Averaged composite IQ Offset (in average cycle) of the selected timeslot	99.99 dB

Name	Corresponding Results	Format
Time Offset	n=1 27th Averaged composite timing error (in average cycle) of the selected timeslot, relative to the timing reference (DwPTS/UpPTS/Trig)	99.999 chips

I/Q Measured Polar Vector Window

This window provides composite IQ polar vector.

NOTE Marker operation is not supported in this window.

Name	Corresponding Results	Format
Composite Constellation	The I/Q polar trace of measured input data within the selected timeslot. Coupled with normalize: If normalize is set off, un-normalized input I/Q data will be displayed (n=3); If normalize is set on, normalized input I/Q data will be displayed (n=4); The length displayed is defined by I/Q Points.	Vector/Constellation Vector Constellation
Active Channels	n=1 33rd Number of active code channels of the selected timeslot	99
Slot	Number of current timeslot which is under measurement	TSi, (i=0, 1, ..., 6) DwPTS UpPTS

View - IQ Error

There are four windows in this view:

- [Magnitude Error Window](#) (top left)
- [Phase Error Window](#) (top right)
- [EVM Window](#) (bottom left)
- [Result Metrics Window](#) (bottom right)

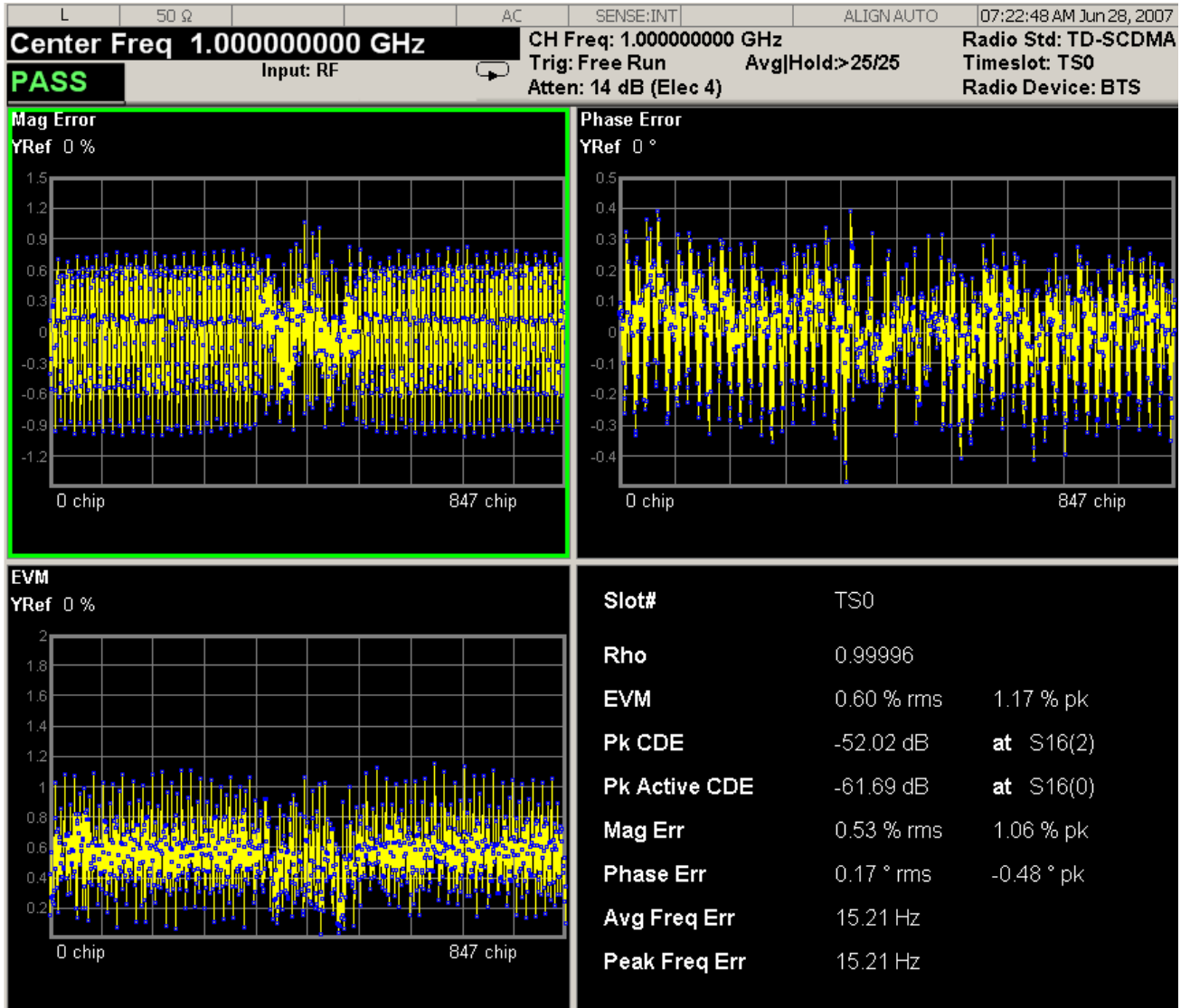

Magnitude Error Window

This window provides magnitude error vs. chip results in the selected analyze timeslot.

Marker Trace	Yes
Corresponding Trace	Magnitude Error vs. Chip trace of the selected timeslot (n=5)

Phase Error Window

This window provides phase error vs. chip results in the selected analyze timeslot.

Marker Trace	Yes
Corresponding Trace	Phase Error vs. Chip trace of the selected timeslot (n=6)

Name	Corresponding Results	Format
Pk Active CDE Position	n=1 31st Code length of peak hold Peak Active CDE (in average cycle) of the selected timeslot, X of SX(Y); n=1 32nd Code index of peak hold Peak Active CDE (in average cycle) of the selected timeslot, Y of SX(Y)	SX(Y) X: OVFSF code length (1,2,4,8,16) Y: OVFSF code index (0, ... X-1)
RMS Mag Err	n=1 7th Averaged composite RMS Magnitude Error (in average cycle) of the selected timeslot	99.99 % rms
Pk Mag Err	n=1 9th Averaged composite Peak Magnitude Error (in average cycle) in the selected timeslot and sub-frame n=1 10th Peak hold composite Peak Magnitude Error (in average cycle) in the selected timeslot and sub-frame	99.99 % pk
RMS Phase Err	n=1 11th Averaged composite RMS Phase Error (in average cycle) of the selected timeslot	99.99 ° rms
Pk Phase Err	n=1 13th Averaged composite Peak Phase Error (in average cycle) in the selected timeslot and sub-frame n=1 14th Peak hold composite Peak Phase Error (in average cycle) in the selected timeslot and sub-frame	99.99 ° pk
Avg Freq Err	n=1 19th Averaged composite Frequency Error (in average cycle) in the selected timeslot and sub-frame	99.99 Hz
Peak Freq Err	n=1 20th Peak hold composite Frequency Error (in average cycle) in the selected timeslot and sub-frame	99.99 Hz

View – Code Domain Power

There are two windows in this view:

1. [Code Domain Power Window](#) (Top)
2. [Code Domain Power Summary Window](#) (Down)

Modulation Accuracy (Composite EVM) Measurement
View/Display

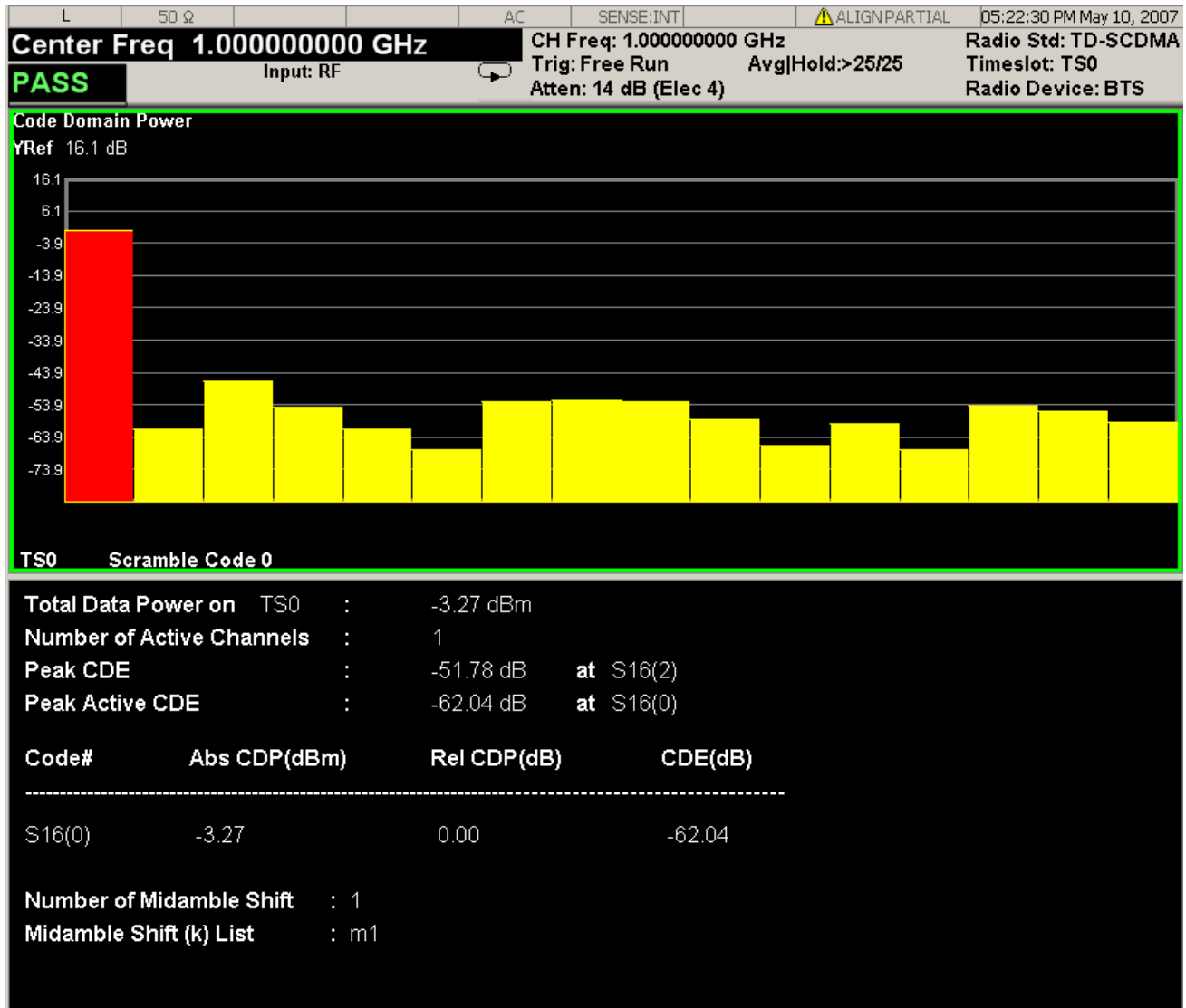

Code Domain Power Window

This window provides a list of all channel codes within the code set with their power separately.

Marker Trace	Yes
Corresponding Trace	Code Domain Power vs. code trace of the selected timeslot. Coupled with normalize: if normalize is set off, un-normalized power vs. code trace in dBm will be displayed (n=10); If normalize is set on, normalized power vs. code trace in dB will be displayed (n=11)

Code Domain Power Summary Window

This window provides the total power, number of active channels, and a table of active channel codes with their powers (in dB and dBm) and CDE separately.

Name	Corresponding Results	Format
Slot	The slot under measurement within the analyzed sub-frame TS0, DwPTS, UpPTS, TS1, TS2, TS3, TS4, TS5, TS6	TSi, (i=0, 1, ..., 6) DwPTS UpPTS
Total Data Power	n=1 34th Total data part power of the selected time slot	-99.99 dBm
Number of Active Channels	n=1 33rd Number of active channels in the selected time slot	99
Pk CDE	n=1 16th Peak hold Peak Code Domain Error (all the code channels, including active and inactive, in average cycle) of the selected timeslot	99.99 dB
Pk CDE Position	n=1 29th Code length of peak hold Peak CDE (in average cycle) of the selected timeslot, X of SX(Y); n=1 30th Code index of peak hold Peak CDE (in average cycle) of the selected timeslot, Y of SX(Y)	SX(Y) X: OVFSF code length (1,2,4,8,16) Y: OVFSF code index (0, ... X-1)
Pk Act CDE	n=1 18th Peak hold Peak Active CDE (active code channels, in average cycle) of the selected timeslot	99.99 dB
Pk Active CDE Position	n=1 31st Code length of peak hold Peak Active CDE (in average cycle) of the selected timeslot, X of SX(Y); n=1 32nd Code index of peak hold Peak Active CDE (in average cycle) of the selected timeslot, Y of SX(Y)	SX(Y) X: OVFSF code length (1,2,4,8,16) Y: OVFSF code index (0, ... X-1)
Code	Spread code number list of active channels	SX(Y), X: OVFSF code length (1,2,4,8,16) Y: OVFSF code index (0, ... X-1)
Abs CDP (dBm)	Absolute power list of active code channels in dBm	99.99

Modulation Accuracy (Composite EVM) Measurement
View/Display

Name	Corresponding Results	Format
Rel CDP (dB)	Normalized Power list of active code channels in dB	99.99
Rel CDE (dB)	Normalized Code domain error list of active code channels	99.99
Number of Midamble Shifts	The number of midamble shift detected in a timeslot.	99
Midamble Shift (k) List	All of the midamble shifts detected in a timeslot.	mi, mi, mi,,, i: The midamble shift

View – Capture Time Summary

There are two windows in this view:

1. [Capture Time Data Trace Window](#) (Top)
2. [Capture Time Summary Window](#) (Down)

The Time trace shows the pre-demodulation time record data. The Capture Interval parameter determines the amount of time data that is displayed. The selected timeslot is marked out by lines.

The summary window at the bottom lists total power, left data power, midamble power, right data power and timing error of each time slot within the analysis sub-frame (TS0, DwPTS, UpPTS, TS1, TS2, TS3, TS4, TS5, TS6).

timing error for each timeslot within the analyzed sub-frame.

Name	Corresponding Results	Format
Slot	The slot under measurement within the analyzed sub-frame. TS0, DwPTS, UpPTS, TS1, TS2, ..., TS6	TSi, (i=0, 1, ..., 6) DwPTS UpPTS
TotalPwr	Total power of each slot within the analysis sub-frame (n=13)	99.99
DataPwrL	Power of data before midamble (left hand data) of each slot within the analysis sub-frame (n=15)	99.99
MidamblePwr	Midamble power of each slot within the analysis sub-frame (n=14)	99.99
DataPwrR	Power of data after midamble (right hand data) of each slot within the analysis sub-frame (n=16)	99.99
Time Offset	Timing error of each slot within the analysis sub-frame (n=17)	99.999

View – Numeric Results

There is one window [Numeric Results Summary Window](#), which shows the summary of modulation accuracy result metrics.

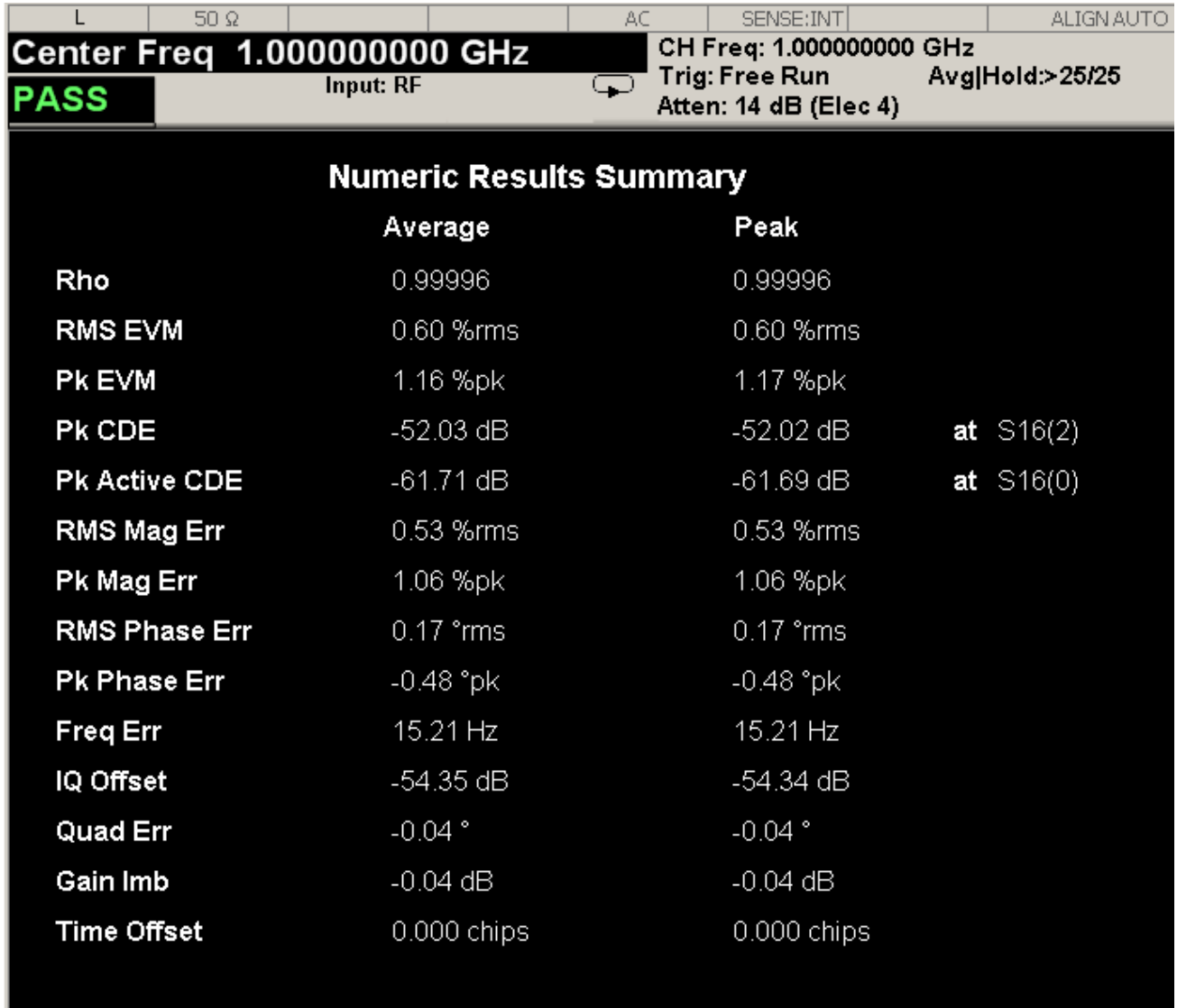

Numeric Results Summary Window

This window shows the results summary window.

Name	Corresponding Results	Format
Rho	n=1 1st Averaged composite Rho (in average cycle) in the selected timeslot and sub-frame n=1 2nd Peak hold composite Rho (in average cycle) in the selected timeslot and sub-frame	9.99999

Modulation Accuracy (Composite EVM) Measurement
View/Display

Name	Corresponding Results	Format
RMS EVM	<p>n=1 3rd</p> <p>Averaged composite RMS EVM (in average cycle) in the selected timeslot and sub-frame</p> <p>n=1 4th</p> <p>Peak hold composite RMS EVM (in average cycle) in the selected timeslot and sub-frame</p>	99.99 % rms
Pk EVM	<p>n=1 5th</p> <p>Averaged composite Peak EVM (in average cycle) in the selected timeslot and sub-frame</p> <p>n=1 6th</p> <p>Peak hold composite Peak EVM (in average cycle) in the selected timeslot and sub-frame</p>	99.99 % pk
Pk CDE	<p>n=1 15th</p> <p>Averaged Peak Code Domain Error (of all the code channels, including active and inactive, in average cycle) in the selected timeslot and sub-frame</p> <p>n=1 16th</p> <p>Peak hold Peak Code Domain Error (of all the code channels, including active and inactive, in average cycle) in the selected timeslot and sub-frame</p>	99.99 dB
Pk CDE Position	<p>n=1 29th</p> <p>Code length of peak hold Peak CDE (in average cycle) of the selected timeslot, X of SX(Y);</p> <p>n=1 30th</p> <p>Code index of peak hold Peak CDE (in average cycle) of the selected timeslot, Y of SX(Y)</p>	<p>SX(Y)</p> <p>X: OVVSF code length (1,2,4,8,16)</p> <p>Y: OVVSF code index (0, ... X-1)</p>
Pk Active CDE	<p>n=1 17th</p> <p>Averaged Peak Active Code Domain Error (of all the code channels, including active and inactive, in average cycle) in the selected timeslot and sub-frame</p> <p>n=1 18th</p> <p>Peak hold Peak Active Code Domain Error (of all the code channels, including active and inactive, in average cycle) in the selected timeslot and sub-frame</p>	99.99 dB

Name	Corresponding Results	Format
Pk Active CDE Position	n=1 31st Code length of peak hold Peak Active CDE (in average cycle) of the selected timeslot, X of SX(Y); n=1 32nd Code index of peak hold Peak Active CDE (in average cycle) of the selected timeslot, Y of SX(Y)	SX(Y) X: OVFSF code length (1,2,4,8,16) Y: OVFSF code index (0, ... X-1)
RMS Mag Err	n=1 7th Averaged composite RMS Magnitude Error (in average cycle) in the selected timeslot and sub-frame n=1 8th Peak hold composite RMS Magnitude Error (in average cycle) in the selected timeslot and sub-frame	99.99 % rms
Pk Mag Err	n=1 9th Averaged composite Peak Magnitude Error (in average cycle) in the selected timeslot and sub-frame n=1 10th Peak hold composite Peak Magnitude Error (in average cycle) in the selected timeslot and sub-frame	99.99 % pk
RMS Phase Err	n=1 11th Averaged composite RMS Phase Error (in average cycle) in the selected timeslot and sub-frame n=1 12th Peak hold composite RMS Phase Error (in average cycle) in the selected timeslot and sub-frame	99.99 ° rms
Pk Phase Err	n=1 13th Averaged composite Peak Phase Error (in average cycle) in the selected timeslot and sub-frame n=1 14th Peak hold composite Peak Phase Error (in average cycle) in the selected timeslot and sub-frame	99.99 ° pk
Freq Err	n=1 19th Averaged composite Frequency Error (in average cycle) in the selected timeslot and sub-frame n=1 20th Peak hold composite Frequency Error (in average cycle) in the selected timeslot and sub-frame	99.99 Hz

Name	Corresponding Results	Format
IQ Offset	n=1 21st Averaged composite IQ Offset (in average cycle) in the selected timeslot and sub-frame n=1 22nd Peak hold composite IQ Offset (in average cycle) in the selected timeslot and sub-frame	99.99 dB
Quad Err	n=1 23rd Averaged composite Quad Error (in average cycle) in the selected timeslot and sub-frame n=1 24th Peak hold composite Quad Error (in average cycle) in the selected timeslot and sub-frame	99.99 °
IQ Imb	n=1 25th Averaged composite IQ Imbalance (in average cycle) in the selected timeslot and sub-frame n=1 26th Peak hold composite IQ Imbalance (in average cycle) in the selected timeslot and sub-frame	99.99 dB
Time Offset	n=1 27th Averaged composite Time Offset (in average cycle) in the selected timeslot and sub-frame, relative to the timing reference (DwPTS/UpPTS/Trig) n=1 28th Peak hold composite Time Offset (in average cycle) in the selected timeslot and sub-frame, relative to the timing reference (DwPTS/UpPTS/Trig)	99.999 chips

Display

Refer to “[Display](#)” on page 1307 in the "Common Measurement Functions" for more information.

View Selection

Allows you to select the desired measurement view from the following selections:

- I/Q Measured Polar Graph
- I/Q Error (quad view).
- Code Domain Power
- Capture Time Summary

- Numeric Results.

Remote Command	:DISPlay:EVM:VIEW[:SElect] POLar ERRor PGRaph SUMMARY NRESults :DISPlay:EVM:VIEW[:SElect]?
Example	:DISPlay:EVM:VIEW POLAr :DISPlay:EVM:VIEW?
Key Path	View/Display
Mode	TD-SCDMA
Preset	POLAr
State Saved	Saved in instrument state.
Range	I/Q Measured Polar Graph I/Q Error Code Domain Power Capture Time Summary Numeric Results
Instrument S/W Revision	A.01.60 or later

View Selection by number (Remote Command only)

Allows you to select the desired measurement view from the following selections by Remote Commands:

- I/Q Measured Polar Graph
- I/Q Error (quad view).
- Code Domain Power
- Capture Time Summary
- Numeric Results.
-

Remote Command	:DISPlay:EVM:VIEW:NSElect <integer> :DISPlay:EVM:VIEW:NSElect?
Example	DISP:EVM:VIEW:NSEL 1 DISP:EVM:VIEW:NSEL?
Mode	TD-SCDMA

Modulation Accuracy (Composite EVM) Measurement
View/Display

Notes	Meaning of the numeric values: 1 = I/Q Measured Polar Graph View 2 = I/Q Error View 3 = Code Domain View 4 = Capture Time Summary View 5 = Numeric Results View
Preset	1
State Saved	Saved in instrument state.
Min	1
Max	5
Test MIN/MAX/DEF	No
Instrument S/W Revision	A.01.60 or later

View Settings

View/Settings menu for I/Q Measured Polar Vector Window

Modify display settings for the polar graph.

Key Path	Front Panel
Instrument S/W Revision	A.01.60 or later

I/Q Polar Vec/Constln

Selects from one of the three polar display types the format of the Polar Graph display. You can select one of the following formats:

- Vector & Constellation
- Vector
- Constellation

Remote Command	:DISPlay:EVM:IQPTType VCONstln VECTor CONStln :DISPlay:EVM:IQPTType?
Example	:DISP:EVM:IQPT VCON :DISP:EVM:IQPT?
Key Path	View/Display, I/Q Measured Polar Graph
Mode	TD-SCDMA

Notes	<p>Three polar display types:</p> <ul style="list-style-type: none"> • Vec&Constln: Sets the view to display both the vector and constellation diagrams • Vector: Sets the view to display an I/Q polar vector diagram • Constellation: Sets the view to display the constellation diagram
Preset	VCONstln
Instrument S/W Revision	A.01.60 or later

Vector & Constellation

Sets the view to display both the vector and constellation diagrams.

Key Path	View/Display, I/Q Measured Polar Graph, I/Q Polar Vec/Constl
Example	:DISPlay:EVM:IQPTtype VCONstln :DISPlay:EVM:IQPTtype?
Instrument S/W Revision	A.01.60 or later

Vector

Sets the view to display an I/Q polar vector diagram.

Key Path	View/Display, I/Q Measured Polar Graph, I/Q Polar Vec/Constl
Example	:DISPlay:EVM:IQPTtype VECTor :DISPlay:EVM:IQPTtype?
Instrument S/W Revision	A.01.60 or later

Constellation

Sets the view to display the constellation diagram.

Key Path	View/Display, I/Q Measured Polar Graph, I/Q Polar Vec/Constl
Example	:DISPlay:EVM:IQPTtype CONSTln :DISPlay:EVM:IQPTtype?
Instrument S/W Revision	A.01.60 or later

I/Q Points

This key specifies the total number of I/Q points displayed during each measurement interval in the I/Q measured Polar Vector Graph.

Remote Command	:DISPlay:EVM:IQPoints <integer> :DISPlay:EVM:IQPoints?
-----------------------	---

Modulation Accuracy (Composite EVM) Measurement
View/Display

Dependencies/Couplings	See Notes.
Example	:DISP:EVM:IQP 80 :DISP:EVM:IQP?
Key Path	View/Display, I/Q Measured Polar Graph, I/Q Points
Mode	TD-SCDMA
Notes	I/Q Points + I/Q Points Offset \leq 848. If the I/Q Points defined is larger than the 848, the I/Q Points will be set 848.
Preset	848
State Saved	Saved in instrument state.
Min	1
Max	848
Test MIN/MAX/DEF	Yes
Test UP/DOWN	10
Instrument S/W Revision	A.01.60 or later

I/Q Points Offset

This key specifies an offset from the first I/Q point in the I/Q Polar diagrams. If you choose to display only a subset of the I/Q points, this subset of displayed points is offset from the first I/Q point.

Remote Command	:DISPlay:EVM:IQPoints:OFFSet <integer> :DISPlay:EVM:IQPoints:OFFSet?
Dependencies/Couplings	See Notes.
Example	:DISP:EVM:IQP:OFFS 14 :DISP:EVM:IQP:OFFS?
Key Path	View/Display, I/Q Measured Polar Graph, I/Q Points Offset
Mode	TD-SCDMA
Notes	I/Q Points + I/Q Points Offset \leq 848. If I/Q Points Offset > (848 – I/Q Points), I/Q Points Offset is set (848 – I/Q Points).
Preset	0 chip
State Saved	Saved in instrument state.
Min	0 chip
Max	847 chips
Test MIN/MAX/DEF	Yes

Test UP/DOWN	10
Instrument S/W Revision	A.01.60 or later

I/Q Rotation

Specifies whether or not the 45 degrees rotation is applied to the I/Q constellation.

Remote Command	:DISPlay:EVM:ROtation OFF ON 0 1 :DISPlay:EVM:ROtation?
Example	:DISP:EVM:ROT ON :DISP:EVM:ROT?
Key Path	View/Display, I/Q Measured Polar Graph, I/Q Rotation
Mode	TD-SCDMA
Preset	OFF
State Saved	Saved in instrument state.
Range	On Off
Test MIN/MAX/DEF	No
Instrument S/W Revision	A.01.60 or later

Interpolation

This key specifies whether the input I/Q data should be interpolated.

Remote Command	:DISPlay:EVM:INTerpolate OFF ON 0 1 :DISPlay:EVM:INTerpolate?
Example	:DISP:EVM:INT ON :DISP:EVM:INT?
Key Path	View/Display, I/Q Measured Polar Graph, Interpolation
Mode	TD-SCDMA
Preset	OFF
State Saved	Saved in instrument state.
Range	On Off
Test MIN/MAX/DEF	No
Instrument S/W Revision	A.01.60 or later

Full Vector (background)

When Full Vector is off, the I/Q data is displayed from (I/Q Offset + 1), with length I/Q Points, in the

Modulation Accuracy (Composite EVM) Measurement
View/Display

selected timeslot and sub-frame. The points before (I/Q Offset + 1) will not be displayed.

When Full Vector is on, the trace will show all the I/Q vector in the selected timeslot and sub-frame, the hidden portion (the points before the I/Q offset) is displayed in gray.

Remote Command	:DISPlay:EVM:FVEctor[:STATe] OFF ON 0 1 :DISPlay:EVM:FVEctor[:STATe]?
Example	:DISP:EVM:FVEC ON :DISP:EVM:FVEC?
Key Path	View/Display, I/Q Measured Polar Graph, Full Vector
Mode	TD-SCDMA
Preset	OFF
State Saved	Saved in instrument state.
Range	On Off
Test MIN/MAX/DEF	No
Instrument S/W Revision	A.01.60 or later

View/Settings menu Code Domain Power Summary Window

If the Code Domain Power Summary window in the Code Domain Power view is active, the View/Display key accesses the menu that enables the following controls to read the active channel list:

- Prev Page - Returns one page back to the previous page of measurement results.
- Next Page - Moves one page forward to the next page of measurement results.
- Scroll Up - Moves one line upward from the current page of measurement results each time the key is pressed.
- Scroll Down - Moves one line downward from the current page of measurement results each time the key is pressed.
- First Page - Moves from the current page to the first page of measurement results.
- Last Page - Moves from the current page to the last page of measurement results.

Key Path	View/Display, CDP Graph & Metics, Composite (Summary window selected) View/Display, CDE Graph & Metics, Composite (Summary window selected) View/Display, Code Domain (Summary window selected) View/Display, Demod Bits
Instrument S/W Revision	A.01.60 or later

Prev Page

Moves one page back to the previous page of the measurement results.

Key Path	View/Display, CDP Graph & Metics, Composite (Summary window selected) View/Display, CDE Graph & Metics, Composite (Summary window selected) View/Display, Code Domain (Summary window selected) View/Display, Demod Bits
Notes	No SCPI
Instrument S/W Revision	A.01.60 or later

Next Page

Moves one page forward to the previous page of the measurement results.

Key Path	View/Display, CDP Graph & Metics, Composite (Summary window selected) View/Display, CDE Graph & Metics, Composite (Summary window selected) View/Display, Code Domain (Summary window selected) View/Display, Demod Bits
Notes	No SCPI
Instrument S/W Revision	A.01.60 or later

Scroll Down

Moves one line downward from the current page of the measurement results by each press.

Key Path	View/Display, CDP Graph & Metics, Composite (Summary window selected) View/Display, CDE Graph & Metics, Composite (Summary window selected) View/Display, Code Domain (Summary window selected) View/Display, Demod Bits
Notes	No SCPI
Instrument S/W Revision	A.01.60 or later

Scroll Up

Modulation Accuracy (Composite EVM) Measurement
View/Display

Moves one line up from the current page of the measurement results by each press.

Key Path	View/Display, CDP Graph & Metics, Composite (Summary window selected) View/Display, CDE Graph & Metics, Composite (Summary window selected) View/Display, Code Domain (Summary window selected) View/Display, Demod Bits
Notes	No SCPI
Instrument S/W Revision	A.01.60 or later

First Page

Moves from the current page to the first page of the measurement results by each press.

Key Path	View/Display, CDP Graph & Metics, Composite (Summary window selected) View/Display, CDE Graph & Metics, Composite (Summary window selected) View/Display, Code Domain (Summary window selected) View/Display, Demod Bits
Notes	No SCPI
Instrument S/W Revision	A.01.60 or later

Last Page

Moves from the current page to the last page of the measurement results by each press.

Key Path	View/Display, CDP Graph & Metics, Composite (Summary window selected) View/Display, CDE Graph & Metics, Composite (Summary window selected) View/Display, Code Domain (Summary window selected) View/Display, Demod Bits
Notes	No SCPI
Instrument S/W Revision	A.01.60 or later

The waveform measurement is a generic measurement for viewing the input signal waveforms in the time domain. This measurement represents how the instrument performs the zero span functionality found in traditional spectrum analyzers. For more details, see [“Waveform Measurement Description” on page 932](#) below.

This topic contains the following sections:

[“Measurement Commands for Waveform” on page 931](#)

[“Remote Command Results for Waveform Measurement” on page 931](#)

Measurement Commands for Waveform

The general functionality of CONFigure, INITiate, FETCh, MEASure, and READ are described at this section.

:CONFigure:WAVeform

:CONFigure:WAVeform:NDEFault

:INITiate:WAVeform

:FETCh:WAVeform[n]

:MEASure:WAVeform[n]

:READ:WAVeform[n]

For more measurement related commands, see the SENSE subsystem, and the section [“Remote Measurement Functions” on page 1127](#).

Remote Command Results for Waveform Measurement

The following table denotes the returned results from the FETCh|MEASure|READ commands:

n	Results Returned
0	Returns unprocessed I/Q trace data, as a series of trace point values, in volts. The I values are listed first in each pair, using the 0 through even-indexed values. The Q values are the odd-indexed values.

- 1 Returns the following scalar results:
 1. Sample Time is a floating point number representing the time between samples when using the trace queries (n=0, 2, and so forth).
 2. Mean Power is the mean power (in dBm). This is the power across the entire trace. If averaging is on, the power is for the latest acquisition.
 3. Mean Power Averaged is the power (in dBm) for N averages, if averaging is on. This is the power across the entire trace. If averaging is on, the power is for the latest acquisition. If averaging is off, the value of the mean power averaged is the same as the value of the mean power.
 4. Number of samples is the number of data points in the captured signal. This number is useful when performing a query on the signal (i.e. when n=0,2,etc.).
 5. Peak-to-mean ratio has units of dB. This is the ratio of the maximum signal level to the mean power. Valid values are only obtained with averaging turned off. If averaging is on, the peak-to-mean ratio is calculated using the highest peak value, rather than the displayed average peak value.
 6. Maximum value is the maximum of the most recently acquired data (in dBm).
 7. Minimum value is the minimum of the most recently acquired data (in dBm).
- 2 Returns trace point values of the entire captured signal envelope trace data. These data points are floating point numbers representing the power of the signal (in dBm). There are N data points, where N is the number of samples. The period between the samples is defined by the sample time.

Waveform Measurement Description

Also available under basic Waveform measurement is an I/Q window, which shows the I and Q signal waveforms in parameters of voltage versus time to disclose the voltages which comprise the complex modulated waveform of a digital signal.

The waveform measurement can also be used to perform general purpose power measurements to a high degree of accuracy.

Key Path	Front-panel key
Instrument S/W Revision	Prior to A.02.00

AMPTD Y Scale

Accesses a menu of functions that enable you to set the vertical scale parameters.

Key Path	Front-panel key
Instrument S/W Revision	Prior to A.02.00

Ref Value

Sets the absolute power reference value. However, since the Auto Scaling is defaulted to On, this value is automatically determined by the measurement result. When you set a value manually, Auto Scaling automatically changes to Off.

Ref Value (RF Envelope View)

Sets the Y Scale reference value (in dBm) when the RF Envelope View is active. By default, the measurement determines the reference value with Auto Scaling. Entering a reference value manually turns Auto Scaling off.

Key Path	AMPTD Y Scale
Mode	BASIC, PN, WCDMA, C2K, GSM, WIMAX OFDMA, TD-SCDMA, 1xEV-DO, DVB-T/H, DTMB
Remote Command	:DISPlay:WAVEform:VIEW[1]:WINDow[1]:TRACe:Y[:SCALE]:RLEV <ampl> :DISPlay:WAVEform:VIEW[1]:WINDow[1]:TRACe:Y[:SCALE]:RLEV?
Example	DISP:WAV:VIEW:WIND:TRAC:Y:RLEV -50 dBm DISP:WAV:VIEW:WIND:TRAC:Y:RLEV?
Notes	You must be in the mode that includes Waveform measurement to use this command. Use INSTRument:SElect to set the mode.
Dependencies/Couplings	When the Auto Scaling is On, this value is automatically determined by the measurement result. When you set a value manually, Auto Scaling automatically changes to Off.
Preset	10.00 dBm
State Saved	Saved in instrument state.
Range	-250.00 dBm to 250.00 dBm
Instrument S/W Revision	Prior to A.02.00

Ref Value (I/Q Waveform View)

Sets the Y Scale reference value (in volts) when the I/Q Waveform View is active. By default, the

Waveform Measurement

AMPTD Y Scale

measurement determines the reference value with Auto Scaling. Entering a reference value manually turns Auto Scaling off.

Key Path	AMPTD Y Scale
Mode	BASIC, PN, WCDMA, C2K, GSM, WIMAX OFDMA, TD-SCDMA, 1xEV-DO, DVB-T/H, DTMB
Remote Command	:DISPlay:WAVeform:VIEW2:WINDow[1]:TRACe:Y[:SCALE]:RLEVe l <voltage> :DISPlay:WAVeform:VIEW2:WINDow[1]:TRACe:Y[:SCALE]:RLEVe l?
Example	DISP:WAV:VIEW2:WIND:TRAC:Y:RLEV 25 V DISP:WAV:VIEW2:WIND:TRAC:Y:RLEV?
Notes	You must be in the mode that includes Waveform measurement to use this command. Use INSTRument:SElect to set the mode.
Dependencies/Couplings	When the Auto Scaling is On, this value is automatically determined by the measurement result. When you set a value manually, Auto Scaling automatically changes to Off.
Preset	0 V
State Saved	Saved in instrument state.
Min	-250 V
Max	250 V
Instrument S/W Revision	Prior to A.02.00

Attenuation

Accesses a menu of functions that enable you to change the attenuation settings. This key has a readback text that describes total attenuator value

This is only available when the selected input is RF.

See AMPTD Y Scale, “Attenuation” on page 1037 in the section “Common Measurement Functions” for more information.

Key Path	AMPTD Y Scale
Instrument S/W Revision	Prior to A.02.00

Range

Accesses the Range menu to change baseband I/Q gain settings. This key has a readback text that describes gain range value. Refer to “Amplitude Y Scale (AMPTD Y Scale)” on page 1037 in the

section “Common Measurement Functions” for more information.

Key Path	AMPTD Y Scale
Instrument S/W Revision	Prior to A.02.00

Scale/Div

Sets the units per division of vertical scale in the logarithmic display. However, since the Auto Scaling is defaulted to On, this value is automatically determined by the measurement result. When you set a value manually, Auto Scaling automatically changes to Off.

Scale/Div (RF Envelope View)

Sets the scale per division for the RF Envelope result waveform (time domain) measurements in the graph window.

Key Path	AMPTD Y Scale
Mode	BASIC, PN, WCDMA, C2K, GSM, WIMAX OFDMA, TD-SCDMA, 1xEV-DO, DVB-T/H, DTMB
Remote Command	:DISPlay:WAVEform:VIEW[1]:WINDow[1]:TRACe:Y[:SCALe]:PDI Vision <rel_ampl> :DISPlay:WAVEform:VIEW[1]:WINDow[1]:TRACe:Y[:SCALe]:PDI Vision?
Example	DISP:WAV:VIEW:WIND:TRAC:Y:PDIV 5 DISP:WAV:VIEW:WIND:TRAC:Y:PDIV?
Notes	You must be in the mode that includes Waveform measurement to use this command. Use INSTRument:SElect to set the mode.
Dependencies/Couplings	When the Auto Scaling is On, this value is automatically determined by the measurement result. When you set a value manually, Auto Scaling automatically changes to Off.
Preset	10.00 dB
State Saved	Saved in instrument state.
Range	0.10 dB to 20.00 dB
Instrument S/W Revision	Prior to A.02.00

Scale/Div (I/Q Waveform View)

Sets the scale per division for the I/ Q signal waveform graph.

Key Path	AMPTD Y Scale
Mode	BASIC, PN, WCDMA, C2K, GSM, WIMAX OFDMA, TD-SCDMA, 1xEV-DO, DVB-T/H, DTMB

Waveform Measurement

AMPTD Y Scale

Remote Command	<code>:DISPlay:WAVEform:VIEW2:WINDow[1]:TRACe:Y[:SCALE]:PDIVi sion <voltage></code> <code>:DISPlay:WAVEform:VIEW2:WINDow[1]:TRACe:Y[:SCALE]:PDIVi sion?</code>
Example	<code>DISP:WAV:VIEW2:WIND:TRAC:Y:PDIV 25mV</code> <code>DISP:WAV:VIEW2:WIND:TRAC:Y:PDIV?</code>
Notes	You must be in the mode that includes Waveform measurement to use this command. Use <code>INSTrument:SELEct</code> to set the mode.
Dependencies/Couplings	When the Auto Scaling is On, this value is automatically determined by the measurement result. When you set a value manually, Auto Scaling automatically changes to Off.
Preset	100.0 mV
State Saved	Saved in instrument state.
Min	1.0 nV
Max	20 V
Instrument S/W Revision	Prior to A.02.00

Presel Center

When this key is pressed, the centering of the preselector filter is adjusted to optimize the amplitude accuracy at the frequency of the selected marker.

See [“Presel Center” on page 1049](#) under AMPTD Y Scale in the section "Common Measurement Functions" for more information.

This key is only available when the selected input is RF.

Key Path	AMPTD/Y Scale
Instrument S/W Revision	Prior to A.02.00

Presel Adjust

Allows you to manually adjust the preselector filter frequency to optimize its response to the signal of interest. This function is only available when Presel Center is available.

See [“Preselector Adjust” on page 1050](#) under AMPTD Y Scale in the section "Common Measurement Functions" for more information.

This key is only available when the selected input is RF.

Key Path	AMPTD/Y Scale
Instrument S/W Revision	Prior to A.02.00

Internal Preamp

Accesses a menu of functions that enable you to control the internal preamplifiers.

See AMPTD Y Scale, “[Internal Preamp](#)” on page 1052 in the section “Common Measurement Functions” for more information.

This key is only available when the selected input is RF.

Key Path	AMPTD Y Scale
Instrument S/W Revision	Prior to A.02.00

Ref Position

Positions the reference level at the top, center or bottom of the Y Scale display. Changing the reference position does not change the reference level value.

Ref Position (RF Envelope View)

Positions the reference level at the top, center or bottom of the Y Scale display. Changing the reference position does not change the reference level value.

Key Path	AMPTD Y Scale
Mode	BASIC, PN, WCDMA, C2K, GSM, WIMAX OFDMA, TD-SCDMA, 1xEV-DO, DVB-T/H, DTMB
Remote Command	:DISPlay:WAVEform:VIEW[1]:WINDow[1]:TRACe:Y[:SCALE]:RPO Sition TOP CENTer BOTTom :DISPlay:WAVEform:VIEW[1]:WINDow[1]:TRACe:Y[:SCALE]:RPO Sition?
Example	DISP:WAV:VIEW:WIND:TRAC:Y:RPOS CENT DISP:WAV:VIEW:WIND:TRAC:Y:RPOS?
Notes	You must be in the mode that includes Waveform measurement to use this command. Use INSTRUMENT:SElect to set the mode.
Preset	TOP
State Saved	Saved in instrument state.
Range	Top Ctr Bot
Instrument S/W Revision	Prior to A.02.00

Ref Position (I/Q Waveform View)

Positions the reference level at the top, center or bottom of the Y Scale display. Changing the reference position does not change the reference level value.

Key Path	AMPTD Y Scale
----------	----------------------

Waveform Measurement

AMPTD Y Scale

Mode	BASIC, PN, WCDMA, C2K, GSM, WIMAX OFDMA, TD-SCDMA, 1xEV-DO, DVB-T/H, DTMB
Remote Command	:DISPlay:WAVeform:VIEW2:WINDow[1]:TRACe:Y[:SCALe]:RPOSi tion TOP CENTer BOTTom :DISPlay:WAVeform:VIEW2:WINDow[1]:TRACe:Y[:SCALe]:RPOSi tion?
Example	DISP:WAV:VIEW2:WIND:TRAC:Y:RPOS CENT DISP:WAV:VIEW2:WIND:TRAC:Y:RPOS?
Notes	You must be in the mode that includes Waveform measurement to use this command. Use INSTRument:SELEct to set the mode.
Preset	CENT
State Saved	Saved in instrument state.
Range	Top Ctr Bot
Instrument S/W Revision	Prior to A.02.00

Auto Scaling

Toggles the Auto Scaling function between On and Off. When the **Restart** front panel key is pressed, this function automatically determines the scale per division and reference values based on the measurement results.

Key Path	AMPTD Y Scale
Mode	BASIC, PN, WCDMA, C2K, GSM, WIMAX OFDMA, TD-SCDMA, 1xEV-DO, DVB-T/H, DTMB
Remote Command	:DISPlay:WAVeform:VIEW[1] 2:WINDow[1]:TRACe:Y[:SCALe]:C OUPle 0 1 OFF ON :DISPlay:WAVeform:VIEW[1] 2:WINDow[1]:TRACe:Y[:SCALe]:C OUPle?
Example	DISP:WAV:VIEW:WIND:TRAC:Y:COUP OFF DISP:WAV:VIEW:WIND:TRAC:Y:COUP?
Notes	You must be in the mode that includes Waveform measurement to use this command. Use INSTRument:SELEct to set the mode.
Dependencies/Couplings	When Auto Scaling is On, upon pressing the Restart front-panel key, this function automatically switches the scale per division and reference values into the defaults. When the user sets a value to either Scale/Div or Ref Value manually, Auto Scaling automatically changes to Off.
Preset	OFF
State Saved	Saved in instrument state.

Range

On|Off

Instrument S/W Revision

Prior to A.02.00

Auto Couple

See “**AUTO COUPLE**” on page 1055 in the section “Common Measurement Functions” for more information.

BW

Accesses a menu that enables you to control the information bandwidth functions of the instrument. You can also select the filter type for the measurement.

Key Path	Front-panel key
Instrument S/W Revision	Prior to A.02.00

Info BW

Enables you to set the information bandwidth (Info BW) of the analyzer.

Key Path	BW
Mode	BASIC, PN, WCDMA, C2K, GSM, WIMAX OFDMA, TD-SCDMA, 1xEV-DO, DVB-T/H, DTMB
Remote Command	[:SENSe]:WAVEform:BANDwidth[:RESolution] <freq> [:SENSe]:WAVEform:BANDwidth[:RESolution]?
Example	WAV:BAND 1kHz WAV:BAND?
Notes	You must be in the mode that includes Waveform measurement to use this command. Use INSTRument:SElect to set the mode.
Preset	All except GSM/EDGE: 100 kHz GSM/EDGE: 510kHz TDSCDMA: 1.3MHZ 1xEVDO: 1.3MHz DVB-T/H: 8.0MHz DTMB: 8.0MHz
State Saved	Saved in instrument state.
Min	10 Hz

Waveform Measurement

BW

Max	Hardware Dependent: RF Input: No Option = 10 MHz Option B25 = 25 MHz I/Q Input: No Option = 10 MHz per channel (20 MHz for I+jQ) Option B25 = 25 MHz per channel (50 MHz for I+jQ) Option S40 = 40 MHz per channel (80 MHz for I+jQ)
Instrument S/W Revision	Prior to A.02.00

IBW Control

Accesses the Filter Type key

Key Path	BW
Instrument S/W Revision	Prior to A.02.00

Filter Type

Selects the type of bandwidth filter that is used. The choices are Gaussian or Flat top.

Key Path	BW, RBW Control
Mode	BASIC, PN, WCDMA, C2K, GSM, WIMAX OFDMA, TD-SCDMA, 1xEV-DO, DVB-T/H, DTMB
Remote Command	[:SENSE]:WAVEform:BANDwidth:SHAPE GAUSSian FLATtop [:SENSE]:WAVEform:BANDwidth:SHAPE?
Example	WAV:BAND:SHAP GAUS WAV:BAND:SHAP?
Notes	You must be in the mode that includes Waveform measurement to use this command. Use INSTRument:SElect to set the mode.
Preset	GAUSSian
State Saved	Saved in instrument state.
Range	Gaussian FlatTop
Instrument S/W Revision	Prior to A.02.00

Gaussian The table in the section [“Gaussian filters”](#) on page 943 lists all 160 Gaussian filter types.

Gaussian filters

Normal (-3 dB)	-6 dB	Noise	Impulse
1.0 Hz	1.41 Hz	1.06 Hz	1.49 Hz
1.1 Hz	1.55 Hz	1.16 Hz	1.63 Hz
1.2 Hz	1.69 Hz	1.27 Hz	1.77 Hz
1.3 Hz	1.83 Hz	1.37 Hz	1.92 Hz
1.5 Hz	2.11 Hz	1.59 Hz	2.22 Hz
1.6 Hz	2.25 Hz	1.69 Hz	2.37 Hz
1.8 Hz	2.53 Hz	1.90 Hz	2.66 Hz
2.0 Hz	2.81 Hz	2.12 Hz	2.96 Hz
2.2 Hz	3.09 Hz	2.33 Hz	3.25 Hz
2.4 Hz	3.38 Hz	2.54 Hz	3.55 Hz
2.7 Hz	3.80 Hz	2.86 Hz	3.99 Hz
3.0 Hz	4.22 Hz	3.17 Hz	4.44 Hz
3.3 Hz	4.64 Hz	3.49 Hz	4.88 Hz
3.6 Hz	5.06 Hz	3.81 Hz	5.32 Hz
3.9 Hz	5.49 Hz	4.12 Hz	5.77 Hz
4.3 Hz	6.05 Hz	4.55 Hz	6.36 Hz
4.7 Hz	6.61 Hz	4.97 Hz	6.95 Hz
5.1 Hz	7.17 Hz	5.39 Hz	7.54 Hz
5.6 Hz	7.87 Hz	5.92 Hz	8.27 Hz
6.2 Hz	8.72 Hz	6.56 Hz	9.17 Hz
6.8 Hz	9.55 Hz	7.18 Hz	10.0 Hz
7.5 Hz	10.5 Hz	7.93 Hz	11.1 Hz
8.2 Hz	11.5 Hz	8.66 Hz	12.1 Hz
9.1 Hz	12.8 Hz	9.64 Hz	13.5 Hz
10 Hz	14.0 Hz	10.6 Hz	14.8 Hz
11 Hz	15.4 Hz	11.6 Hz	16.2 Hz
12 Hz	16.9 Hz	12.7 Hz	17.7 Hz
13 Hz	18.3 Hz	13.7 Hz	19.2 Hz
15 Hz	21.1 Hz	15.9 Hz	22.2 Hz

Waveform Measurement
BW

16 Hz	22.5 Hz	16.9 Hz	23.7 Hz
18 Hz	25.3 Hz	19.1 Hz	26.6 Hz
20 Hz	28.1 Hz	21.1 Hz	29.5 Hz
22 Hz	30.9 Hz	23.2 Hz	32.5 Hz
24 Hz	33.8 Hz	25.4 Hz	35.5 Hz
27 Hz	38.0 Hz	28.6 Hz	40.0 Hz
30 Hz	42.3 Hz	31.8 Hz	44.5 Hz
33 Hz	46.3 Hz	34.8 Hz	48.7 Hz
36 Hz	50.7 Hz	38.1 Hz	53.3 Hz
39 Hz	54.9 Hz	41.3 Hz	57.7 Hz
43 Hz	60.5 Hz	45.5 Hz	63.6 Hz
47 Hz	66.1 Hz	49.7 Hz	69.5 Hz
51 Hz	71.7 Hz	53.9 Hz	75.3 Hz
56 Hz	78.9 Hz	59.3 Hz	83.0 Hz
62 Hz	87.3 Hz	65.6 Hz	91.7 Hz
68 Hz	95.5 Hz	71.8 Hz	100 Hz
75 Hz	106 Hz	79.4 Hz	111 Hz
82 Hz	115 Hz	86.8 Hz	121 Hz
91 Hz	128 Hz	96.4 Hz	135 Hz
100 Hz	141 Hz	106 Hz	148 Hz
110 Hz	154 Hz	116 Hz	162 Hz
120 Hz	169 Hz	127 Hz	178 Hz
130 Hz	183 Hz	137 Hz	192 Hz
150 Hz	211 Hz	159 Hz	222 Hz
160 Hz	225 Hz	169 Hz	237 Hz
180 Hz	253 Hz	190 Hz	266 Hz
200 Hz	281 Hz	211 Hz	295 Hz
220 Hz	309 Hz	232 Hz	325 Hz
240 Hz	337 Hz	254 Hz	355 Hz
270 Hz	380 Hz	286 Hz	400 Hz
300 Hz	422 Hz	317 Hz	444 Hz
330 Hz	463 Hz	348 Hz	487 Hz

360 Hz	507 Hz	381 Hz	533 Hz
390 Hz	550 Hz	413 Hz	578 Hz
430 Hz	605 Hz	455 Hz	636 Hz
470 Hz	662 Hz	498 Hz	696 Hz
510 Hz	718 Hz	540 Hz	755 Hz
560 Hz	789 Hz	593 Hz	829 Hz
620 Hz	872 Hz	655 Hz	916 Hz
680 Hz	958 Hz	720 Hz	1.01 kHz
750 Hz	1.06 kHz	794 Hz	1.11 kHz
820 Hz	1.15 kHz	866 Hz	1.21 kHz
910 Hz	1.28 kHz	964 Hz	1.35 kHz
1.0 kHz	1.41 kHz	1.06 kHz	1.48 kHz
1.1 kHz	1.55 kHz	1.17 kHz	1.63 kHz
1.2 kHz	1.69 kHz	1.27 kHz	1.78 kHz
1.3 kHz	1.83 kHz	1.38 kHz	1.93 kHz
1.5 kHz	2.11 kHz	1.59 kHz	2.22 kHz
1.6 kHz	2.26 kHz	1.70 kHz	2.37 kHz
1.8 kHz	2.54 kHz	1.91 kHz	2.67 kHz
2.0 kHz	2.82 kHz	2.12 kHz	2.96 kHz
2.2 kHz	3.10 kHz	2.33 kHz	3.26 kHz
2.4 kHz	3.38 kHz	2.54 kHz	3.56 kHz
2.7 kHz	3.80 kHz	2.86 kHz	4.00 kHz
3.0 kHz	4.23 kHz	3.18 kHz	4.44 kHz
3.3 kHz	4.65 kHz	3.49 kHz	4.89 kHz
3.6 kHz	5.06 kHz	3.81 kHz	5.32 kHz
3.9 kHz	5.48 kHz	4.12 kHz	5.76 kHz
4.3 kHz	6.07 kHz	4.56 kHz	6.38 kHz
4.7 kHz	6.62 kHz	4.98 kHz	6.96 kHz
5.1 kHz	7.16 kHz	5.38 kHz	7.53 kHz
5.6 kHz	7.87 kHz	5.92 kHz	8.27 kHz
6.2 kHz	8.74 kHz	6.57 kHz	9.18 kHz
6.8 kHz	9.58 kHz	7.20 kHz	10.1 kHz

Waveform Measurement
BW

7.5 kHz	10.5 kHz	7.92 kHz	11.1 kHz
8.2 kHz	11.5 kHz	8.66 kHz	12.1 kHz
9.1 kHz	12.8 kHz	9.64 kHz	13.5 kHz
10 kHz	14.1 kHz	10.6 kHz	14.8 kHz
11 kHz	15.4 kHz	11.6 kHz	16.2 kHz
12 kHz	16.9 kHz	12.7 kHz	17.8 kHz
13 kHz	18.3 kHz	13.7 kHz	19.2 kHz
15 kHz	21.2 kHz	15.9 kHz	22.3 kHz
16 kHz	22.4 kHz	16.8 kHz	23.5 kHz
18 kHz	25.2 kHz	19.0 kHz	26.5 kHz
20 kHz	28.4 kHz	21.3 kHz	29.8 kHz
22 kHz	31.2 kHz	23.4 kHz	32.8 kHz
24 kHz	33.8 kHz	25.4 kHz	35.6 kHz
27 kHz	38.1 kHz	28.7 kHz	40.1 kHz
30 kHz	42.1 kHz	31.7 kHz	44.3 kHz
33 kHz	46.8 kHz	35.2 kHz	49.2 kHz
36 kHz	50.1 kHz	37.7 kHz	52.7 kHz
39 kHz	54.8 kHz	41.2 kHz	57.6 kHz
43 kHz	61.1 kHz	46.0 kHz	64.3 kHz
47 kHz	66.2 kHz	49.8 kHz	69.6 kHz
51 kHz	72.3 kHz	54.3 kHz	76.0 kHz
56 kHz	79.5 kHz	59.8 kHz	83.6 kHz
62 kHz	86.3 kHz	64.9 kHz	90.8 kHz
68 kHz	96.5 kHz	72.6 kHz	101 kHz
75 kHz	106 kHz	79.7 kHz	111 kHz
82 kHz	114 kHz	86.0 kHz	120 kHz
91 kHz	129 kHz	97.3 kHz	136 kHz
100 kHz	140 kHz	105 kHz	147 kHz
110 kHz	154 kHz	116 kHz	162 kHz
120 kHz	169 kHz	127 kHz	178 kHz
130 kHz	182 kHz	137 kHz	192 kHz
150 kHz	210 kHz	158 kHz	221 kHz

160 kHz	223 kHz	168 kHz	235 kHz
180 kHz	253 kHz	190 kHz	266 kHz
200 kHz	280 kHz	211 kHz	295 kHz
220 kHz	308 kHz	232 kHz	324 kHz
240 kHz	336 kHz	253 kHz	353 kHz
270 kHz	380 kHz	286 kHz	400 kHz
300 kHz	420 kHz	316 kHz	441 kHz
330 kHz	467 kHz	352 kHz	491 kHz
360 kHz	506 kHz	380 kHz	532 kHz
390 kHz	550 kHz	414 kHz	578 kHz
430 kHz	599 kHz	451 kHz	629 kHz
470 kHz	660 kHz	497 kHz	693 kHz
510 kHz	715 kHz	538 kHz	750 kHz
560 kHz	786 kHz	592 kHz	826 kHz
620 kHz	867 kHz	653 kHz	912 kHz
680 kHz	952 kHz	717 kHz	1.00 MHz
750 kHz	1.05 MHz	791 kHz	1.10 MHz
820 kHz	1.14 MHz	859 kHz	1.19 MHz
910 kHz	1.27 MHz	960 kHz	1.34 MHz
1.0 MHz	1.40 MHz	1.06 MHz	1.47 MHz
1.1 MHz	1.53 MHz	1.15 MHz	1.61 MHz
1.2 MHz	1.66 MHz	1.26 MHz	1.75 MHz
1.3 MHz	1.80 MHz	1.36 MHz	1.89 MHz
1.5 MHz	2.06 MHz	1.56 MHz	2.17 MHz
1.6 MHz	2.19 MHz	1.66 MHz	2.29 MHz
1.8 MHz	2.51 MHz	1.91 MHz	2.63 MHz
2.0 MHz	2.75 MHz	2.10 MHz	2.88 MHz
2.2 MHz	3.00 MHz	2.30 MHz	3.14 MHz
2.4 MHz	3.30 MHz	2.54 MHz	3.45 MHz
2.7 MHz	3.63 MHz	2.81 MHz	3.78 MHz
3.0 MHz	4.09 MHz	3.18 MHz	4.22 MHz
4 MHz	5.30 MHz	4.23 MHz	5.30 MHz

Waveform Measurement
BW

5 MHz	5.78 MHz	4.81 MHz	5.41 MHz
6 MHz	6.31 MHz	5.50 MHz	5.82 MHz
8 MHz	8.07 MHz	7.21 MHz	6.90 MHz

Flattop The table in the section “[Flattop Filters](#)” on page [949](#) lists all 134 Flattop filter types.

Flattop Filters

3.0 Hz	3.3 Hz	3.6 Hz	3.9 Hz
4.3 Hz	4.7 Hz	5.1 Hz	5.6 Hz
6.2 Hz	6.8 Hz	7.5 Hz	8.2 Hz
9.1 Hz	10 Hz	11 Hz	12 Hz
13 Hz	15 Hz	16 Hz	18 Hz
20 Hz	22 Hz	24 Hz	27 Hz
30 Hz	33 Hz	36 Hz	39 Hz
43 Hz	47 Hz	51 Hz	56 Hz
62 Hz	68 Hz	75 Hz	82 Hz
91 Hz	100 Hz	110 Hz	120 Hz
130 Hz	150 Hz	160 Hz	180 Hz
200 Hz	220 Hz	240 Hz	270 Hz
300 Hz	330 Hz	360 Hz	390 Hz
430 Hz	470 Hz	510 Hz	560 Hz
620 Hz	680 Hz	750 Hz	820 Hz
910 Hz	1.0 kHz	1.1 kHz	1.2 kHz
1.3 kHz	1.5 kHz	1.6 kHz	1.8 kHz
2.0 kHz	2.2 kHz	2.4 kHz	2.7 kHz
3.0 kHz	3.3 kHz	3.6 kHz	3.9 kHz
4.3 kHz	4.7 kHz	5.1 kHz	5.6 kHz
6.2 kHz	6.8 kHz	7.5 kHz	8.2 kHz
9.1 kHz	10 kHz	11 kHz	12 kHz
13 kHz	15 kHz	16 kHz	18 kHz
20 kHz	22 kHz	24 kHz	27 kHz
30 kHz	33 kHz	36 kHz	39 kHz
43 kHz	47 kHz	51 kHz	56 kHz
62 kHz	68 kHz	75 kHz	82 kHz
91 kHz	100 kHz	110 kHz	120 kHz
130 kHz	150 kHz	160 kHz	180 kHz
200 kHz	220 kHz	240 kHz	270 kHz

Waveform Measurement
BW

300 kHz	330 kHz	390 kHz	430 kHz
510 kHz	620 kHz	750 kHz	1.0 MHz
1.5 MHz	3.0 MHz	4 MHz	5 MHz
6 MHz	8 MHz		

Cont

See “[Cont \(Continuous Measurement/Sweep\)](#)” on page 1059 in the section "Common Measurement Functions" for more information.

FREQ Channel

See “[Frequency/Channel](#)” on page 1061 in the section “Common Measurement Functions” for more information.

Input/Output

See “[Input/Output](#)” on page 1065 in the section “Common Measurement Functions” for more information.

Marker

Accesses a menu that enables you to select, set up and control the markers for the current measurement. See “[Marker](#)” on page 1123 in the section "Common Measurement Functions" for more information

Key Path	Front-panel key
Instrument S/W Revision	Prior to A.02.00

Select Marker

Displays 12 markers available for selection.

Key Path	Marker
Instrument S/W Revision	Prior to A.02.00

Marker Type

Sets the marker control mode to **Normal**, **Delta**, **Fixed** or **Off**. All interactions and dependencies detailed under the key description are enforced when the remote command is sent. If the selected marker is Off, pressing Marker sets it to Normal and places it at the center of the screen on the trace determined by the **Marker Trace** rules. At the same time, **Marker X Axis Value** appears on the Active Function area.

The default active function is the active function for the currently selected marker control mode. If the current control mode is Off, there is no active function and the active function is turned off.

Key Path	Marker
Mode	BASIC, PN, WCDMA, C2K, GSM, WIMAX OFDMA, TD-SCDMA, 1xEV-DO, DVB-T/H, DTMB
Remote Command	:CALCulate:WAVeform:MARKer[1] 2 3 4 5 6 7 8 9 10 11 12: MODE POSition DELTA OFF :CALCulate:WAVeform:MARKer[1] 2 3 4 5 6 7 8 9 10 11 12: MODE?
Example	CALC:WAV:MARK:MODE OFF CALC:WAV:MARK:MODE?

Notes	<p>If the selected marker is Off, pressing Marker sets it to Normal and places it at the center of the screen on the trace determined by the Marker Trace rules. At the same time, Marker X Axis Value appears on the Active Function area.</p> <p>Default Active Function: the active function for the selected marker's current control mode. If the current control mode is Off, there is no active function and the active function is turned off.</p> <p>Active Function Display: the marker X axis value entered in the active function area displays the marker value to its full entered precision.</p> <p>You must be in the mode that Waveform measurement is included to use this command. Use INSTRUMENT:SElect to set the mode.</p>
Preset	=OFF
Preset	OFF
State Saved	Saved in instrument state.
Range	Normal Delta Off
Instrument S/W Revision	Prior to A.02.00

Marker X Axis Value (Remote Command only)

Sets the marker X Axis value in the current marker X Axis Scale unit. It has no effect if the control mode is **Off**, but is the SCPI equivalent of entering an X value if the control mode is **Normal** or **Delta**.

Mode	BASIC, PN, WCDMA, C2K, GSM, WIMAX OFDMA, TD-SCDMA, 1xEV-DO, DVB-T/H, DTMB
Remote Command	<pre>:CALCulate:WAVEform:MARKer[1] 2 3 4 5 6 7 8 9 10 11 12: X <time></pre> <pre>:CALCulate:WAVEform:MARKer[1] 2 3 4 5 6 7 8 9 10 11 12: X?</pre>
Example	<pre>CALC:WAV:MARK:X 50 ms</pre> <pre>CALC:WAV:MARK:X?</pre>
Notes	<p>If no suffix is sent, uses the fundamental units for the current marker X Axis Scale. If a suffix is sent that does not match the current marker X Axis Scale unit, an error "Invalid suffix" is generated. If the specified marker is Fixed and a Marker Function is on, error -221 "Settings conflict; cannot adjust Fixed marker while Marker Function is on" is generated.</p> <p>The query returns the marker's absolute X Axis value if the control mode is Normal, or the offset from the marker's reference marker if the control mode is Delta. The query is returned in the fundamental units for the current marker X Axis scale: Hz for Frequency and Inverse Time, seconds for Period and Time. If the marker is Off the response is not a number.</p> <p>You must be in the mode that includes Waveform measurement to use this command. Use INSTRUMENT:SElect to set the mode.</p>
Preset	0

Waveform Measurement Marker

Preset	After a preset, all markers are turned OFF, so Marker X Axis Value query returns a not a number (NAN).
State Saved	No
Min	-9.9E+37
Max	9.9E+37
Instrument S/W Revision	Prior to A.02.00

Marker X Axis Position (Remote Command only)

Sets the marker X position in trace points. It has no effect if the control mode is **Off**, but is the SCPI equivalent of entering a value if the control mode is **Normal** or **Delta**. The entered value is immediately translated into the current X Axis Scale units for setting the value of the marker.

Mode	BASIC, PN, WCDMA, C2K, GSM, WIMAX OFDMA, TD-SCDMA, 1xEV-DO, DVB-T/H, DTMB
Remote Command	:CALCulate:WAVEform:MARKer[1] 2 3 4 5 6 7 8 9 10 11 12: X:POSition <real> :CALCulate:WAVEform:MARKer[1] 2 3 4 5 6 7 8 9 10 11 12: X:POSition?
Example	CALC:WAV:MARK:X:POS 500 CALC:WAV:MARK:X:POS?
Notes	The query returns the marker's absolute X Axis value in trace points if the control mode is Normal or the offset from the marker's reference marker in trace points if the control mode is Delta . The value is returned as a real number, not an integer, corresponding to the translation from X Axis Scale units to trace points. You must be in the mode that includes Waveform measurement to use this command. Use INSTRument:SELEct to set the mode.
Preset	0
Preset	After a preset, all markers are turned OFF, so Marker X Axis Value query returns a not a number (NAN).
State Saved	No
Min	-9.9E+37
Max	9.9E+37
Instrument S/W Revision	Prior to A.02.00

Marker Y Axis Value (Remote Command only)

Queries the marker Y Axis value in the current marker Y Axis unit.

Mode	BASIC, PN, WCDMA, C2K, GSM, WIMAX OFDMA, TD-SCDMA, 1xEV-DO, DVB-T/H, DTMB
Remote Command	:CALCulate:WAVEform:MARKer[1] 2 3 4 5 6 7 8 9 10 11 12:Y?
Example	CALC:WAV:MARK11:Y?
Notes	When the marker is on, IQ waveform returns I and Q values. Case #1 - Trace RF: returns a single double value. >:CALC:WAV:MARK1:Y? -2.402406506109E+001 Case #2 - Trace IQ: returns a double array of two values, the first is X, and the second is Y. >:CALC:WAV:MARK1:Y? -3.006944493834E-003,+9.9870666467354E-004 You must be in the mode that includes Waveform measurement to use this command. Use INSTRument:SElect to set the mode.
Preset	Result dependant on markers setup and signal source
State Saved	No
Instrument S/W Revision	Prior to A.02.00

Properties

Accesses the marker properties menu.

Key Path	Marker
Instrument S/W Revision	Prior to A.02.00

Select Marker

Displays 12 markers available for selection.

Key Path	Marker
Instrument S/W Revision	Prior to A.02.00

Relative To

Selects the marker that the selected marker is relative to (its reference marker).

Key Path	Marker, Properties
----------	---------------------------

Waveform Measurement Marker

Mode	BASIC, PN, WCDMA, C2K, GSM, WIMAX OFDMA, TD-SCDMA, 1xEV-DO, DVB-T/H, DTMB
Remote Command	:CALCulate:WAVeform:MARKer[1] 2 3 4 5 6 7 8 9 10 11 12:REFerence <integer> :CALCulate:WAVeform:MARKer[1] 2 3 4 5 6 7 8 9 10 11 12:REFerence?
Example	CALC:WAV:MARK:REF 8 CALC:WAV:MARK:REF?
Notes	A marker cannot be relative to itself so that choice is grayed out, and if sent from SCPI generates error -221: "Settings conflict; marker cannot be relative to itself." When queried a single value is returned (the specified marker numbers relative marker). You must be in the mode that Waveform measurement is included to use this command. Use INSTRument:SElect to set the mode.
Preset	2 3 4 5 6 7 8 9 10 11 12 1
State Saved	Saved in instrument state.
Min	1
Max	12
Instrument S/W Revision	Prior to A.02.00

Marker Trace

Assigns the specified marker to the designated trace.

Key Path	Marker
Mode	BASIC, PN, WCDMA, C2K, GSM, WIMAX OFDMA, TD-SCDMA, 1xEV-DO, DVB-T/H, DTMB
Remote Command	:CALCulate:WAVeform:MARKer[1] 2 3 4 5 6 7 8 9 10 11 12:TRACe RFENvelope IQ :CALCulate:WAVeform:MARKer[1] 2 3 4 5 6 7 8 9 10 11 12:TRACe?
Example	CALC:WAV:MARK:TRAC RFEN CALC:WAV:MARK:TRAC?
Notes	Assigns the specified marker to the designated trace. You must be in the mode that includes Waveform measurement to use this command. Use INSTRument:SElect to set the mode.
Preset	RFEN
State Saved	Saved in instrument state.

Range	RF Envelope IQ Waveform
Instrument S/W Revision	Prior to A.02.00

Couple Markers

Toggles the state of the markers to be coupled On or Off. When this function is true (On), moving any marker causes an equal X axis movement of every other marker which is not **Off**. “Equal X axis movement” refers to the difference between each marker’s X Axis value (in the fundamental x-axis units of the trace that marker is on) and the X Axis value of the marker being moved (in the same fundamental x-axis units) are preserved.

Key Path	Marker
Mode	BASIC, PN, WCDMA, C2K, GSM, WIMAX OFDMA, TD-SCDMA, 1xEV-DO, DVB-T/H, DTMB
Remote Command	:CALCulate:WAVEform:MARKer:COUple[:STATE] ON OFF 1 0 :CALCulate:WAVEform:MARKer:COUple[:STATE]?
Example	CALC:WAV:MARK:COUP ON CALC:WAV:MARK:COUP ON
Notes	You must be in the mode that includes Waveform measurement to use this command. Use INSTRUMENT:SElect to set the mode.
Preset	OFF
State Saved	Saved in instrument state.
Range	On Off
Instrument S/W Revision	Prior to A.02.00

All Markers Off

Turns off all markers.

Key Path	Marker
Mode	BASIC, PN, WCDMA, C2K, GSM, WIMAX OFDMA, TD-SCDMA, 1xEV-DO, DVB-T/H, DTMB
Remote Command	:CALCulate:WAVEform:MARKer:AOFF
Example	CALC:WAV:MARK:AOFF
Notes	You must be in the mode that includes Waveform measurement to use this command. Use INSTRUMENT:SElect to set the mode.
Instrument S/W Revision	Prior to A.02.00

Marker Function

Accesses a menu of marker functions that perform post-processing operations on markers based on the measurement specifications. Marker functions are distinct from Measurement functions, which automatically perform complex sequences of setup, data acquisition, and display operations in order to measure specified signal characteristics. Marker Functions are specified for each individual marker and may be turned on individually for each marker.

The **Marker Function** menu controls which marker functions are turned on and allows you to adjust the setup parameters for each function. These parameters include the following, but only one parameter can be assigned to a given marker:

- **Marker Noise**
- **Band/Interval Power**
- **Band/Interval Density**
- **Marker Function Off**

Key Path	Front-panel key
Instrument S/W Revision	Prior to A.02.00

Select Marker

Displays 12 markers available for selection.

Key Path	Marker
Instrument S/W Revision	Prior to A.02.00

Marker Function Type

Sets the marker control function type to, Marker Noise, Band/Interval Power, Band Interval Density, or Marker Function Off

Key Path	Marker Function
Mode	BASIC, PN, WCDMA, C2K, GSM, WIMAX OFDMA, TD-SCDMA, 1xEV-DO, DVB-T/H, DTMB
Remote Command	:CALCulate:WAVeform:MARKer[1] 2 3 4 5 6 7 8 9 10 11 12: FUNction BPOwer BDENsity OFF :CALCulate:WAVeform:MARKer[1] 2 3 4 5 6 7 8 9 10 11 12: FUNction?
Example	CALC:WAV:MARK:FUNC BPOW CALC:WAV:MARK:FUNC?

Notes	You must be in the mode that includes Waveform measurement to use this command. Use INSTRUMENT:SElect to set the mode.
Preset	OFF
State Saved	Saved in instrument state.
Range	Band/Interval Power Band Interval Density Marker Function Off
Instrument S/W Revision	Prior to A.02.00

Band Adjust

Accesses a menu that enables you to set the frequency span width and the left and right edge, or time values, for the band or interval of the selected marker.

Key Path	Marker Function
Instrument S/W Revision	Prior to A.02.00

Band/Interval Span for Time Domain

Sets the width of the frequency span for the selected marker.

Key Path	Marker Function
Mode	BASIC, PN, WCDMA, C2K, GSM, WIMAX OFDMA, TD-SCDMA, 1xEV-DO, DVB-T/H, DTMB
Remote Command	:CALCulate:WAVEform:MARKer[1] 2 3 4 5 6 7 8 9 10 11 12:FUNCTION:BAND:SPAN <time> :CALCulate:WAVEform:MARKer[1] 2 3 4 5 6 7 8 9 10 11 12:FUNCTION:BAND:SPAN?
Example	CALC:WAV:MARK:FUNC:BAND:SPAN 20 ms CALC:WAV:MARK:FUNC:BAND:SPAN?
Notes	You must be in the mode that includes Waveform measurement to use this command. Use INSTRUMENT:SElect to set the mode.
Dependencies/Couplings	Changing the Band/Interval Span necessarily changes the Band/Interval Left and Band/Interval Right values
Preset	0
Preset	10% of Meas Time
State Saved	Saved in instrument state.
Min	0
Max	100s
Instrument S/W Revision	Prior to A.02.00

Band/Interval Left for Time Domain

Sets the left edge frequency or time value for the band of the selected marker.

Key Path	Marker Function
Mode	BASIC, PN, WCDMA, C2K, GSM, WIMAX OFDMA, TD-SCDMA, 1xEV-DO, DVB-T/H, DTMB
Remote Command	:CALCulate:WAVEform:MARKer[1] 2 3 4 5 6 7 8 9 10 11 12:FUNction:BAND:LEFT <time> :CALCulate:WAVEform:MARKer[1] 2 3 4 5 6 7 8 9 10 11 12:FUNction:BAND:LEFT?
Example	CALC:WAV:MARK12:FUNC:BAND:LEFT 1 s CALC:WAV:MARK12:FUNC:BAND:LEFT?
Notes	You must be in the mode that includes Waveform measurement to use this command. Use INSTRument:SElect to set the mode.
Dependencies/Couplings	Changing the Band/Interval Left necessarily changes the Band/Interval Span and Band/Interval Right values
Preset	0
Preset	5% of Meas Time
State Saved	Saved in instrument state.
Min	0
Max	100s
Instrument S/W Revision	Prior to A.02.00

Band/Interval Right for Time Domain

Sets the right edge frequency or time value for the band of the selected marker.

Key Path	Marker Function
Mode	BASIC, PN, WCDMA, C2K, GSM, WIMAX OFDMA, TD-SCDMA, 1xEV-DO, DVB-T/H, DTMB
Remote Command	:CALCulate:WAVEform:MARKer[1] 2 3 4 5 6 7 8 9 10 11 12:FUNction:BAND:RIGHT <time> :CALCulate:WAVEform:MARKer[1] 2 3 4 5 6 7 8 9 10 11 12:FUNction:BAND:RIGHT?
Example	CALC:WAV:MARK12:FUNC:BAND:RIGH 1 s CALC:WAV:MARK12:FUNC:BAND:RIGH?
Notes	You must be in the mode that includes Waveform measurement to use this command. Use INSTRument:SElect to set the mode.

Dependencies/Couplings	Changing the Band/Interval Left necessarily changes the Band/Interval Span and Band/Interval Right values
Preset	0
Preset	5% of Meas Time
State Saved	Saved in instrument state.
Min	0
Max	100s
Instrument S/W Revision	Prior to A.02.00

Marker To

There is no 'Marker To' functionality supported in Waveform measurements. The front-panel key displays a blank menu key when pressed.

Key Path	Front-panel key
Instrument S/W Revision	Prior to A.02.00

Meas

See [“Meas” on page 1127](#) in the section "Common Measurement Functions" for more information.

Meas Setup

Displays the setup menu keys that enable you to control the parameters for the current measurement.

Key Path	Front-panel key
Instrument S/W Revision	Prior to A.02.00

Average/Hold Number

Sets the number of sweeps (average counts) that are averaged. After the specified number of sweeps, the averaging mode (terminal control) setting determines the averaging action.

Key Path	Meas Setup
Mode	BASIC, PN, WCDMA, C2K, GSM, WIMAX OFDMA, TD-SCDMA, 1xEV-DO, DVB-T/H, DTMB
Remote Command	[:SENSe] :WAVeform:AVERAge:COUNT <integer> [:SENSe] :WAVeform:AVERAge:COUNT? [:SENSe] :WAVeform:AVERAge[:STATe] OFF ON 0 1 [:SENSe] :WAVeform:AVERAge[:STATe]?
Example	WAV:AVER:COUN 1001 WAV:AVER:COUN? WAV:AVER ON WAV:AVER?
Notes	You must be in the mode that includes Waveform measurement to use this command. Use INSTRument:SELEct to set the mode.
Preset	10 OFF
State Saved	Saved in instrument state.
Min	1
Max	20001
Instrument S/W Revision	Prior to A.02.00

Avg Mode

Enables you to set the averaging mode.

When set to Exponential (Exp) the measurement averaging continues using the specified number of averages to compute each averaged value. The average is displayed at the end of each sweep.

When set to Repeat, the measurement resets the average counter each time the specified number of averages is reached.

Key Path	Meas Setup
Mode	BASIC, PN, WCDMA, C2K, GSM, WIMAX OFDMA, TD-SCDMA, 1xEV-DO, DVB-T/H, DTMB
Remote Command	[:SENSe] :WAVeform:AVERage:TCONtrol EXPonential REPEAT [:SENSe] :WAVeform:AVERage:TCONtrol?
Example	WAV:AVER:TCON REP WAV:AVER:TCON?
Notes	You must be in the mode that includes Waveform measurement to use this command. Use INSTRUMENT:SElect to set the mode.
Preset	EXPonential
State Saved	Saved in instrument state.
Range	Exp Repeat
Instrument S/W Revision	Prior to A.02.00

Avg Type

Selects the type of averaging.

Key Path	Meas Setup
Mode	BASIC, PN, WCDMA, C2K, GSM, WIMAX OFDMA, TD-SCDMA, 1xEV-DO, DVB-T/H, DTMB
Remote Command	[:SENSe] :WAVeform:AVERage:TYPE LOG MAXimum MINimum RMS SCALar [:SENSe] :WAVeform:AVERage:TYPE?
Example	WAV:AVER:TYPE MAX WAV:AVER:TYPE?
Notes	The SCPI selection of MAX and MIN are kept because of BWCC reason, but they are removed from the front panel access because they are not Average. You must be in the mode that includes Waveform measurement to use this command. Use INSTRUMENT:SElect to set the mode.
Preset	RMS
State Saved	Saved in instrument state.
Range	Pwr Avg(RMS) Log-Pwr Avg(Video) Voltage Avg
Instrument S/W Revision	Prior to A.02.00

Meas Time

Sets how long the measurement is performed. X Scale only changes the representation of the display.

Key Path	Meas Setup
Mode	BASIC, PN, WCDMA, C2K, GSM, WIMAX OFDMA, TD-SCDMA, 1xEV-DO, DVB-T/H, DTMB
Remote Command	[:SENSE] :WAVEform:SWEep:TIME <time> [:SENSE] :WAVEform:SWEep:TIME?
Example	WAV:SWE:TIME 50 ms WAV:SWE:TIME?
Notes	Specifies and returns how long the measurement is performed. It is the time record length of the measurement waveform. The Max time may be reduced when the sample frequency is high due to the memory limitation. You must be in the mode that includes Waveform measurement to use this command. Use INSTRument:SElect to set the mode.
Preset	2.000000 ms
State Saved	Saved in instrument state.
Range	1.000 μ s to 100.00 s
Instrument S/W Revision	Prior to A.02.00

Meas Preset

Restores all the measurement parameters to their default values.

Key Path	Meas Setup
Mode	BASIC, PN, WCDMA, C2K, GSM, WIMAX OFDMA, TD-SCDMA, 1xEV-DO, DVB-T/H, DTMB
Remote Command	:CONFIgure:WAVEform
Example	CONF:WAV
Notes	Restore default values of all parameters. You must be in the mode that includes Waveform measurement to use this command. Use INSTRument:SElect to set the mode.
Instrument S/W Revision	Prior to A.02.00

Advanced

Accesses a menu of “advanced” functions that are used for specific applications. These settings should

not be changed for most measurements.

Key Path	Meas Setup
Instrument S/W Revision	Prior to A.02.00

ADC Dither

Accesses the ADC Dither control menu.

Key Path	Meas Setup, Advanced
Instrument S/W Revision	Prior to A.02.00

ADC Dither Auto

Sets ADC dithering to automatically select whether dithering is needed.

Key Path	Meas Setup, Advanced, ADC Dither
Mode	BASIC, PN, WCDMA, C2K, GSM, WIMAX OFDMA, TD-SCDMA, 1xEV-DO, DVB-T/H, DTMB
Remote Command	[:SENSe] :WAVeform:ADC:DITHer:AUTO[:STATe] OFF ON 0 1 [:SENSe] :WAVeform:ADC:DITHer:AUTO[:STATe] ?
Example	WAV:ADC:DITH:AUTO ON WAV:ADC:DITH:AUTO?
Notes	The dither function improves linearity for low level signals, at the expense of a higher noise floor. This table is for SCPI definition purpose only. You must be in the mode that includes Waveform measurement to use this command. Use INSTRument:SElect to set the mode.
Preset	OFF
State Saved	Saved in instrument state.
Range	On Off
Instrument S/W Revision	Prior to A.02.00

ADC Dither

Toggles the dither function On and Off. The dither function improves linearity for low level signals, at the expense of a higher noise floor.

The reduced clipping-to-noise ratio results in higher noise, because the clipping level of the ADC relative to the front terminals remains unchanged with the introduction of dither. The enhanced linearity is mostly improved scale fidelity.

With dither on, the third-order distortions are usually invisible for mixer levels below -35 dBm. With dither off, these distortions can be visible, with typical power levels of -110 dBm referred to the mixer. Detection nonlinearity can reach 1 dB for dither off at mixer levels around -70 dBm and lower, while the

Waveform Measurement Meas Setup

specified nonlinearity is many times smaller with dither on.

Key Path	Meas Setup, Advanced, ADC Dither
Mode	BASIC, PN, WCDMA, C2K, GSM, WIMAX OFDMA, TD-SCDMA, 1xEV-DO, DVB-T/H, DTMB
Remote Command	[:SENSe] :WAVeform:ADC:DITHer [:STATe] OFF ON 0 1 [:SENSe] :WAVeform:ADC:DITHer [:STATe] ?
Example	WAV:ADC:DITH ON WAV:ADC:DITH?
Notes	The dither function improves linearity for low level signals, at the expense of a higher noise floor. . You must be in the mode that includes Waveform measurement to use this command. Use INSTRument:SELEct to set the mode.
Preset	OFF
State Saved	Saved in instrument state.
Range	Auto Man
Instrument S/W Revision	Prior to A.02.00

IF Gain

Sets the IF Gain function to Auto, Low Gain or High Gain. These settings affect sensitivity and IF overloads.

This only applies to the RF input. It does not apply to baseband I/Q input.

Key Path	Meas Setup, Advanced
Instrument S/W Revision	Prior to A.02.00

IF Gain Auto

Activates the auto rules for IF Gain. When Auto is active, the IF Gain is set to High Gain under and of the following conditions:

- The input attenuator is set to 0 dB
- the preamp is turned On and the frequency range is under 3.6 GHz

For other settings, Auto sets the IF Gain to Low Gain.

Key Path	Meas Setup, Advanced, IF Gain
Mode	BASIC, PN, WCDMA, C2K, GSM, WIMAX OFDMA, TD-SCDMA, 1xEV-DO, DVB-T/H, DTMB

Remote Command [:SENSe] :WAVeform :IF :GAIN :AUTO [:STATe] ON | OFF | 1 | 0
[:SENSe] :WAVeform :IF :GAIN :AUTO [:STATe] ?

Example WAV:IF:GAIN:AUTO ON
WAV:IF:GAIN:AUTO?

Notes This only applies to the RF input. It does not apply to baseband I/Q input.
You must be in the mode that includes Waveform measurement to use this command. Use INSTRument:SElect to set the mode.

Preset ON

State Saved Saved in instrument state.

Range On|Off

Instrument S/W Revision Prior to A.02.00

IF Gain State

Selects the range of IF gain.

Key Path **Meas Setup, Advanced, IF Gain**

Mode BASIC, PN, WCDMA, C2K, GSM, WIMAX OFDMA, TD-SCDMA, 1xEV-DO, DVB-T/H, DTMB

Remote Command [:SENSe] :WAVeform :IF :GAIN [:STATe] AUTOrange | LOW | HIGH
[:SENSe] :WAVeform :IF :GAIN [:STATe] ?

Example WAV:IF:GAIN HIGH
WAV:IF:GAIN?

Notes This only applies to the RF input and does not apply to baseband I/Q input.
You must be in the mode that includes Waveform measurement to use this command. Use INSTRument:SElect to set the mode.

Preset AUTO

State Saved Saved in instrument state.

Range Autorange (Slower Follows Signals)|Low (Best for Large Signals)|High (Best Noise Level)

Instrument S/W Revision Prior to A.02.00

Mode

See “[Mode](#)” on page 1145 in the section "Common Measurement Functions" for more information.

Mode Setup

See “[Mode Setup](#)” on page 1159 in the section "Common Measurement Functions" for more information.

Peak Search

Places the selected marker on the trace point with the maximum y-axis value for that marker's trace and accesses a menu that enables you to select to do a minimum peak search.

Key Path	Front-panel key
Mode	BASIC, PN, WCDMA, C2K, GSM, WIMAX OFDMA, TD-SCDMA, 1xEV-DO, DVB-T/H, DTMB
Remote Command	:CALCulate:WAVeform:MARKer[1] 2 3 4 5 6 7 8 9 10 11 12:MAXimum
Example	CALC:WAV:MARK2:MAX
Notes	You must be in the mode that includes Waveform measurement to use this command. Use INSTRument:SElect to set the mode.
Instrument S/W Revision	Prior to A.02.00

Next Peak

Moves the selected marker to the next highest local maximum with a value less than the current marker's.

Key Path	Peak Search
Mode	BASIC
Remote Command	:CALCulate:WAVeform:MARKer[1] 2 3 4 5 6 7 8 9 10 11 12:MAXimum:NEXT
Example	CALC:WAV:MARK:MAX:NEXT
Notes	You must be in the mode that includes Waveform measurement to use this command. Use INSTRument:SElect to set the mode.
Instrument S/W Revision	Prior to A.02.00

Min Search

Moves the selected marker to the minimum y-axis value on the current trace.

Key Path	Peak Search
Mode	BASIC, PN, WCDMA, C2K, GSM, WIMAX OFDMA, TD-SCDMA, 1xEV-DO, DVB-T/H, DTMB
Remote Command	:CALCulate:WAVeform:MARKer[1] 2 3 4 5 6 7 8 9 10 11 12:MINimum
Example	CALC:WAV:MARK:MIN

Notes	You must be in the mode that includes Waveform measurement to use this command. Use INSTRUMENT:SElect to set the mode.
Instrument S/W Revision	Prior to A.02.00

Recall

See “[Recall](#)” on page [1179](#) in the section "Common Measurement Functions" for more information.

Restart

See [“Restart” on page 1201](#) in the section "Common Measurement Functions" for more information.

Save

See “[Save](#)” on page 1203 in the section "Common Measurement Functions" for more information.

Single

See “[Single \(Single Measurement/Sweep\)](#)” on page 1229 in the section "Common Measurement Functions" for more information.

Source

See “[Source](#)” on page 1231 in the section "Common Measurement Functions" for more information.

Span X Scale

Accesses a menu of functions that enable you to set the horizontal scale parameters.

Key Path	Front-panel key
Instrument S/W Revision	Prior to A.02.00

Ref Value

Sets the reference value for time on the horizontal axis. When Auto Scaling is set to On, the displayed plots use a Scale/Div value determined by the analyzer, based on the measurement result.

Key Path	SPAN X Scale
Mode	BASIC, PN, WCDMA, C2K, GSM, WIMAX OFDMA, TD-SCDMA, 1xEV-DO, DVB-T/H, DTMB
Remote Command	:DISPlay:WAVEform:VIEW[1] 2:WINDow[1]:TRACe:X[:SCALE]:RLEVEL <time> :DISPlay:WAVEform:VIEW[1] 2:WINDow[1]:TRACe:X[:SCALE]:RLEVEL?
Example	DISP:WAV:VIEW:WIND:TRAC:X:RLEV 10 ms DISP:WAV:VIEW:WIND:TRAC:X:RLEV?
Notes	You must be in the mode that includes Waveform measurement to use this command. Use INSTRument:SElect to set the mode.
Dependencies/Couplings	If the Auto Scaling is set to On, this value is automatically determined by the measurement result. When you set this value manually, Auto Scaling automatically changes to Off.
Preset	0.00 s
State Saved	Saved in instrument state.
Min	-1.000 s
Max	10.00 s
Instrument S/W Revision	Prior to A.02.00

Scale/Div

Sets the horizontal scale by changing a time value per division.

Key Path	SPAN X Scale
Mode	BASIC, PN, WCDMA, C2K, GSM, WIMAX OFDMA, TD-SCDMA, 1xEV-DO, DVB-T/H, DTMB

Waveform Measurement

Span X Scale

Remote Command	:DISPlay:WAVEform:VIEW[1] 2:WINDow[1]:TRACe:X[:SCALe]:PDIVision <time> :DISPlay:WAVEform:VIEW[1] 2:WINDow[1]:TRACe:X[:SCALe]:PDIVision?
Example	DISP:WAV:VIEW:WIND:TRAC:X:PDIV 500 us DISP:WAV:VIEW:WIND:TRAC:X:PDIV?
Notes	You must be in the mode that includes Waveform measurement to use this command. Use INSTRument:SElect to set the mode.
Dependencies/Couplings	If the Auto Scaling is set to On, this value is automatically determined by the measurement result. When you set this value manually, Auto Scaling automatically changes to Off.
Preset	200.0 us
State Saved	Saved in instrument state.
Min	1.000 ns
Max	1.000 s
Instrument S/W Revision	Prior to A.02.00

Ref Position

Sets the reference position for the X axis to Left, Center or Right.

Key Path	SPAN X Scale
Mode	BASIC, PN, WCDMA, C2K, GSM, WIMAX OFDMA, TD-SCDMA, 1xEV-DO, DVB-T/H, DTMB
Remote Command	:DISPlay:WAVEform:VIEW[1] 2:WINDow[1]:TRACe:X[:SCALe]:RPOSition LEFT CENTer RIGHT :DISPlay:WAVEform:VIEW[1] 2:WINDow[1]:TRACe:X[:SCALe]:RPOSition?
Example	DISP:WAV:VIEW:WIND:TRAC:X:RPOS LEFT DISP:WAV:VIEW:WIND:TRAC:X:RPOS?
Notes	Allows you to set the reference position to Left, Ctr (center) or Right. You must be in the mode that includes Waveform measurement to use this command. Use INSTRument:SElect to set the mode.
Preset	LEFT
State Saved	Saved in instrument state.
Range	Left Ctr Right
Instrument S/W Revision	Prior to A.02.00

Auto Scaling

Toggles the scale coupling function between On and Off.

Key Path	SPAN X Scale
Mode	BASIC, PN, WCDMA, C2K, GSM, WIMAX OFDMA, TD-SCDMA, 1xEV-DO, DVB-T/H, DTMB
Remote Command	:DISPlay:WAVEform:VIEW[1] 2:WINDow[1]:TRACe:X[:SCALE]:COUPle 0 1 OFF ON :DISPlay:WAVEform:VIEW[1] 2:WINDow[1]:TRACe:X[:SCALE]:COUPle?
Example	DISP:WAV:VIEW:WIND:TRAC:X:COUP ON DISP:WAV:VIEW:WIND:TRAC:X:COUP?
Notes	You must be in the mode that includes Waveform measurement to use this command. Use INSTRument:SElect to set the mode.
Dependencies/Couplings	When Auto Scaling is On and the Restart front-panel key is pressed, this function automatically determines the scale per division and reference values based on the measurement results. When you set a value to either Scale/Div or Ref Value manually, Auto Scaling automatically changes to Off.
Preset	1
State Saved	Saved in instrument state.
Range	On Off
Instrument S/W Revision	Prior to A.02.00

Sweep/Control

Accesses the Sweep menu that allows you to pause and restart the measurement.

Key Path	Front-panel key
Instrument S/W Revision	Prior to A.02.00

Pause and Resume

Pauses a measurement after the current data acquisition is complete. When Paused, the label on the key changes to Resume. Pressing the Resume key resumes the measurement at the point it was at when paused.

See “[Sweep / Control](#)” on page 1235 in the section "Common Measurement Functions" for more information.

Key Path	Sweep/Control
Instrument S/W Revision	Prior to A.02.00

Trace/Detector

There is no 'Trace/Detector' functionality supported in the Waveform measurement. The front-panel key displays a blank menu key when pressed.

Key Path	Front-panel key
Instrument S/W Revision	Prior to A.02.00

Trigger

Accesses a menu of functions that enable you to select and control the trigger source for the current measurement

See [“Trigger” on page 1253](#) in the section "Common Measurement Functions" for information about all keys in this menu.

Key Path	Front-panel key
Instrument S/W Revision	Prior to A.02.00

View/Display

Accesses a menu of functions that enable you to set up and control the display parameters for the current measurement.

This topic contains the following sections:

[“View Selection by name \(SCPI only\)” on page 987](#)

[“View Selection by number \(SCPI only\)” on page 987](#)

View Selection by name (SCPI only)

Selects the results view.

Key Path	View/Display
Mode	BASIC, PN, WCDMA, C2K, GSM, WIMAX OFDMA, TD-SCDMA, 1xEV-DO, DVB-T/H, DTMB
Remote Command	:DISPlay:WAVeform:VIEW[:SELEct] RFENvelope IQ :DISPlay:WAVeform:VIEW[:SELEct]?
Example	DISP:WAV:VIEW RFEN DISP:WAV:VIEW?
Notes	You must be in the mode that includes Waveform measurement to use this command. Use INSTRument:SELEct to set the mode.
Preset	RFENvelope
State Saved	Saved in instrument state.
Range	RF Envelope IQ Waveform
Instrument S/W Revision	Prior to A.02.00

View Selection by number (SCPI only)

Displays the numeric values of the measurement results.

Mode	BASIC, PN, WCDMA, C2K, GSM, WIMAX OFDMA, TD-SCDMA, 1xEV-DO, DVB-T/H, DTMB
Remote Command	:DISPlay:WAVeform:VIEW:NSELEct <integer> :DISPlay:WAVeform:VIEW:NSELEct?
Example	DISP:WAV:VIEW:NSEL 1 DISP:WAV:VIEW:NSEL?
Notes	You must be in the mode that includes Waveform measurement to use this command. Use INSTRument:SELEct to set the mode.

Waveform Measurement View/Display

Preset	1
State Saved	Saved in instrument state.
Min	1
Max	2
Instrument S/W Revision	Prior to A.02.00
Key Path	Front-panel key
Instrument S/W Revision	Prior to A.02.00

Display

Accesses a menu of functions that enable you to set the display parameters.

See [“Display” on page 1307](#) in the section "Common Measurement Functions" for more information.

Key Path	View/Display
Instrument S/W Revision	Prior to A.02.00

RF Envelop

The view below shows an example of the RF Envelope result for the waveform (time domain) measurements in the graph window. The measured values for the mean power and peak-to-mean power are shown in the text window.

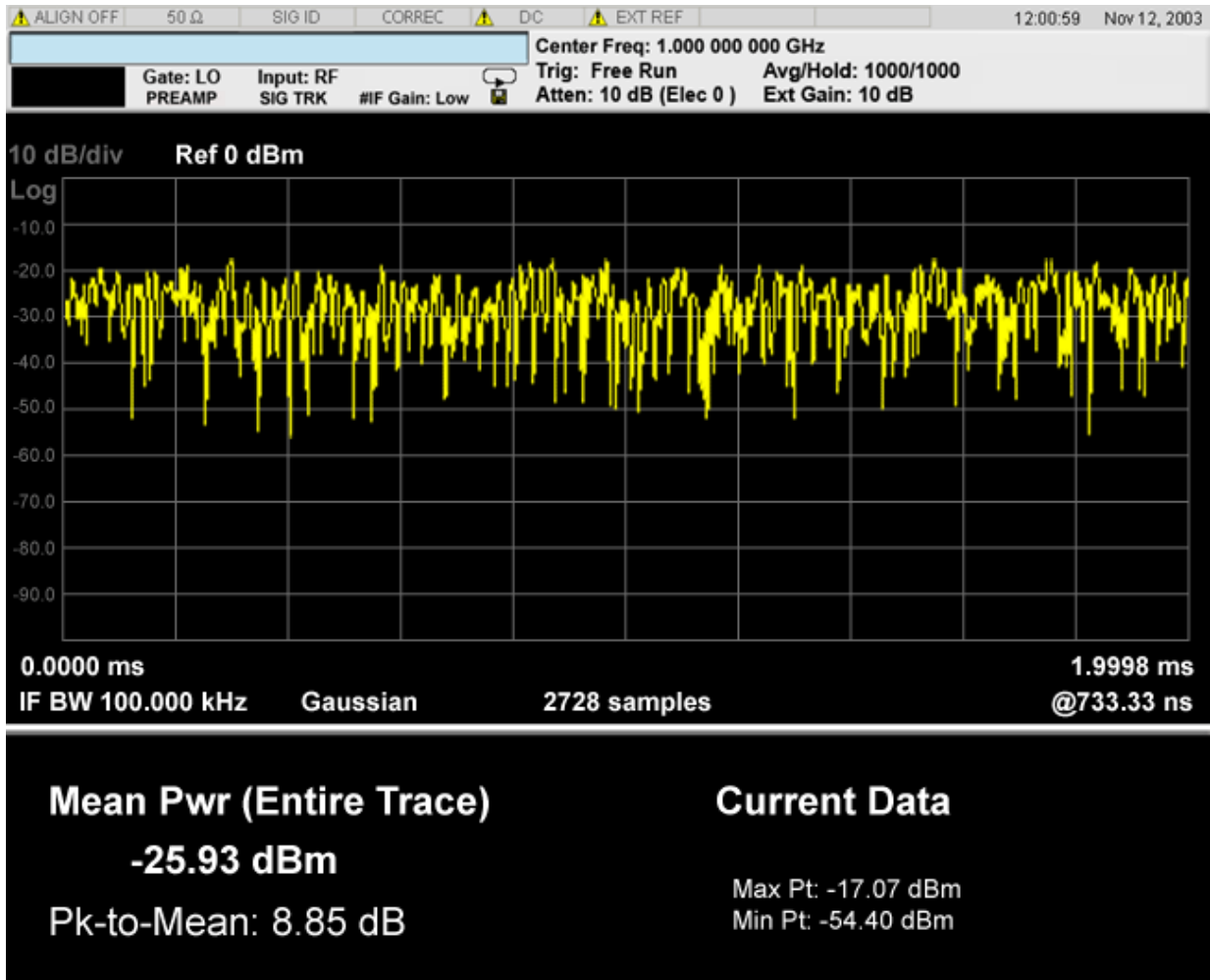

Numeric Results

Name	Type	Description	Unit	Format
Mean Pwr	Float64	The mean power (dBm). This is either the power across the entire trace, or the power between markers if the markers are enabled.	dBm	XX.XX dBm
Pk-to-Mean	Float64	This is the ratio of the maximum signal level to the mean power.	dB	XX.XX dB
Max Pt	Float64	The maximum of the most recently acquired data.	dBm	XX.XX dBm
Min Pt	Float64	The minimum of the most recently acquired data.	dBm	XX.XX dBm

Waveform Measurement
View/Display

Key Path **View/Display**

Instrument S/W Revision Prior to A.02.00

I/Q Waveform

The view below shows the I and Q signal waveforms in parameters of voltage versus time.

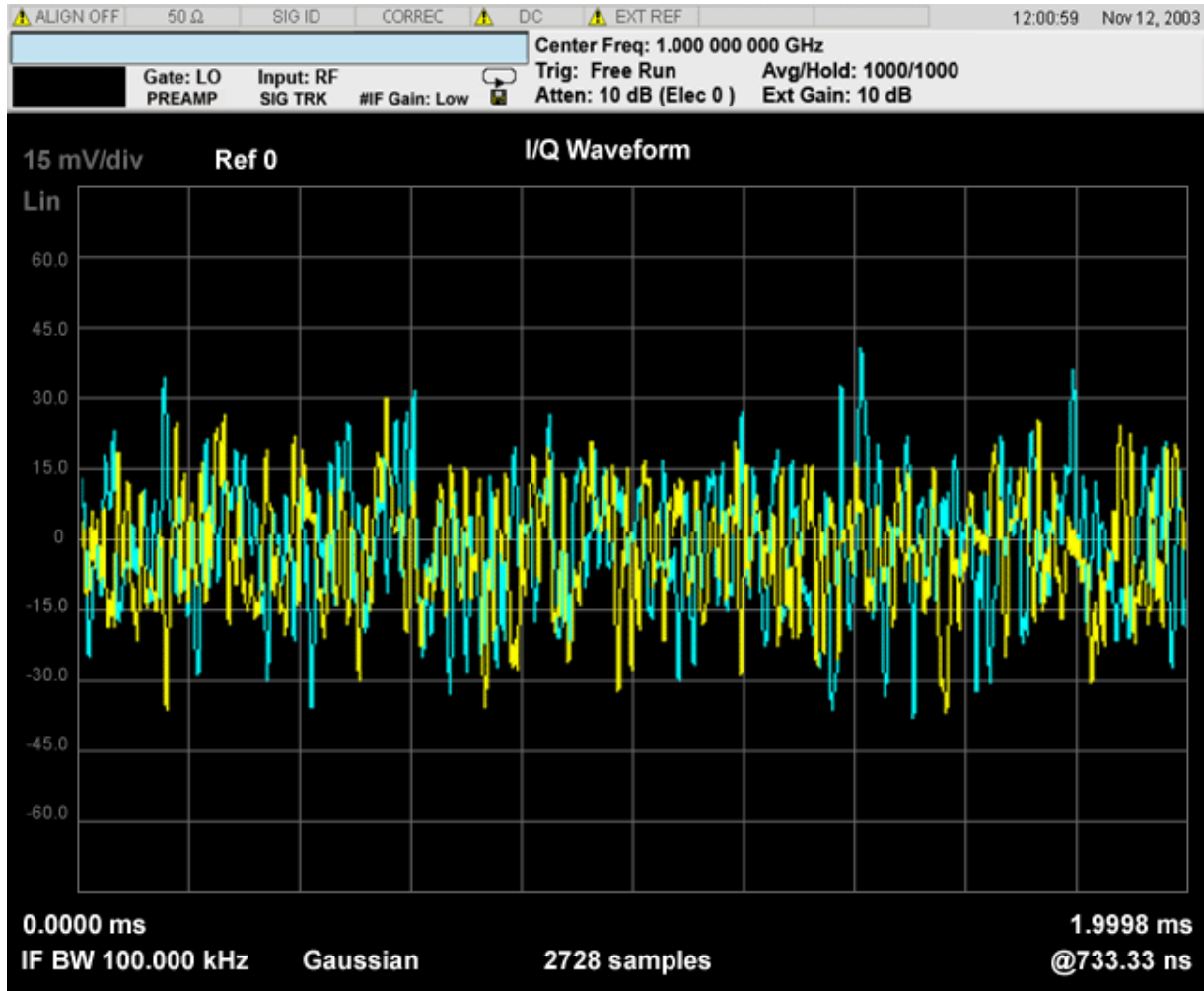

Key Path **View/Display**

Instrument S/W Revision Prior to A.02.00

The monitor spectrum measurement is used as a quick, convenient means of looking at the entire spectrum. While the look and feel are similar to the Spectrum Analyzer mode, the functionality is greatly reduced for easy operation. The main purpose of the measurement is to show the spectrum. The default span should cover an appropriate frequency range of the application. For measurement results and views, see [“View/Display” on page 1033](#).

This topic contains the following sections:

[“Measurement Commands for Monitor Spectrum” on page 991](#)

[“Remote Command Results for Monitor Spectrum Measurement” on page 991](#)

Measurement Commands for Monitor Spectrum

The following commands can be used to retrieve the measurement results:

```
:CONFigure:MONitor
:CONFigure:MONitor:NDEFault
:INITiate:MONitor
:FETCh:MONitor[n]?
:READ:MONitor[n]?
:MEASure:MONitor[n]?
```

For more measurement related commands, see the SENSE subsystem, and the section [“Remote Measurement Functions” on page 1127](#).

Remote Command Results for Monitor Spectrum Measurement

n	Results Returned
n=1 (or not specified)	Returns trace1 data with comma separated floating numbers
n=2	Returns trace2 data with comma separated floating numbers
n=3	Returns trace3 data with comma separated floating numbers

Key Path	Meas
Instrument S/W Revision	Prior to A.02.00

AMPTD Y Scale

Accesses a menu of functions that enable you to set the vertical scale parameters. These functions control how data on the vertical (Y) axis is displayed and control instrument settings that affect the vertical axis.

Key Path	Front-panel key
Instrument S/W Revision	Prior to A.02.00

Ref Value

Sets the absolute power reference value. However, since the Auto Scaling is defaulted to On, this value is automatically determined by the measurement result. When you set a value manually, Auto Scaling automatically changes to Off.

Key Path	AMPTD Y Scale
Mode	All except SA and BASIC
Remote Command	:DISPlay:MONitor:VIEW[1]:WINDow[1]:TRACe:Y[:SCALE]:RLEV el <real> :DISPlay:MONitor:VIEW[1]:WINDow[1]:TRACe:Y[:SCALE]:RLEV el?
Example	DISP:MON:VIEW:WIND:TRAC:Y:RLEV 2.0 DISP:MON:VIEW:WIND:TRAC:Y:RLEV?
Dependencies/Couplings	When the Auto Scaling is On, this value is automatically determined by the measurement result. When you set a value manually, Auto Scaling automatically changes to Off.
Preset	10.00 dBm
State Saved	Saved in instrument state.
Min	-250.00 dBm
Max	250.00 dBm
Instrument S/W Revision	Prior to A.02.00

Attenuation

Accesses a menu of functions that enable you to change the attenuation settings.

See AMPTD Y Scale, “Attenuation” on page 1037 in the “Common Measurement Functions” section for more information.

Key Path	AMPTD Y Scale
----------	----------------------

Instrument S/W Revision Prior to A.02.00

Scale/Div

Sets the logarithmic units per vertical graticule division on the display. However, since the Auto Scaling is defaulted to On, this value is automatically determined by the measurement result. When you set a value manually, Auto Scaling automatically changes to Off.

Key Path	AMPTD Y Scale
Mode	All except SA and BASIC
Remote Command	:DISPlay:MONitor:VIEW[1]:WINDow[1]:TRACe:Y[:SCALe]:PDIV ision <rel_ampl> :DISPlay:MONitor:VIEW[1]:WINDow[1]:TRACe:Y[:SCALe]:PDIV ision?
Example	DISP:MON:VIEW:WIND:TRAC:Y:PDIV 5.0 dB DISP:MON:VIEW:WIND:TRAC:Y:PDIV?
Dependencies/Couplings	When the Auto Scaling is On, this value is automatically determined by the measurement result. When you set a value manually, Auto Scaling automatically changes to Off.
Preset	10.00 dB
State Saved	Saved in instrument state.
Min	0.10 dB
Max	20.00 dB
Instrument S/W Revision	Prior to A.02.00

Presel Center

See AMPTD Y Scale, “[Presel Center](#)” on page 1049 in the “Common Measurement Functions” section for more information.

Presel Adjust

See AMPTD Y Scale, “[Preselector Adjust](#)” on page 1050 in the “Common Measurement Functions” section for more information.

Internal Preamp

Accesses a menu of functions that enable you to control the internal preamplifiers.

See AMPTD Y Scale, “[Internal Preamp](#)” on page 1052 in the “Common Measurement Functions”

Monitor Spectrum Measurement AMPTD Y Scale

section for more information.

Key Path	AMPTD Y Scale
Instrument S/W Revision	Prior to A.02.00

Ref Position

Positions the reference level at the top, center or bottom of the Y Scale display. Changing the reference position does not change the reference level value.

Key Path	AMPTD Y Scale
Mode	All except SA and BASIC
Remote Command	:DISPlay:MONitor:VIEW[1]:WINDow[1]:TRACe:Y[:SCALE]:RPOS ition TOP CENTer BOTTom :DISPlay:MONitor:VIEW[1]:WINDow[1]:TRACe:Y[:SCALE]:RPOS ition?
Example	DISP:MON:VIEW:WIND:TRAC:Y:RPOS CENT DISP:MON:VIEW:WIND:TRAC:Y:RPOS?
Preset	TOP
State Saved	Saved in instrument state.
Range	Top Ctr Bot
Instrument S/W Revision	Prior to A.02.00

Auto Scaling

Toggles the Auto Scaling function between On and Off.

Key Path	AMPTD Y Scale
Mode	All except SA and BASIC
Remote Command	:DISPlay:MONitor:VIEW[1]:WINDow[1]:TRACe:Y[:SCALE]:COUP le 0 1 OFF ON :DISPlay:MONitor:VIEW[1]:WINDow[1]:TRACe:Y[:SCALE]:COUP le?
Example	DISP:MON:VIEW:WIND:TRAC:Y:COUP ON DISP:MON:VIEW:WIND:TRAC:Y:COUP?
Dependencies/Couplings	When Auto Scaling is On, and the Restart front-panel key is pressed, this function automatically determines the scale per division and reference values based on the measurement results. When you set a value to either Scale/Div or Ref Value manually, Auto Scaling automatically changes to Off.

Preset	ON
State Saved	Saved in instrument state.
Range	On Off
Instrument S/W Revision	Prior to A.02.00

Auto Couple

See “**AUTO COUPLE**” on page 1055 in the section “Common Measurement Functions” for more information.

BW

Accesses a menu that enables you to specify the resolution bandwidth functions that control the bandwidth and filter selection.

Key Path	Front-panel key
Instrument S/W Revision	Prior to A.02.00

Res BW

Sets the resolution bandwidth for the current measurement. If an unavailable bandwidth is entered with the numeric keypad, the closest available bandwidth is selected.

Key Path	BW
Mode	All except SA and BASIC
Remote Command	[:SENSE]:MONitor:BANDwidth[:RESolution] <freq> [:SENSE]:MONitor:BANDwidth[:RESolution]? [:SENSE]:MONitor:BANDwidth[:RESolution]:AUTO OFF ON 0 1 [:SENSE]:MONitor:BANDwidth[:RESolution]:AUTO?
Example	MON:BAND 2.4 MHz MON:BAND? MON:BAND:AUTO ON MON:BAND:AUTO?
Preset	WCDMA: Automatically calculated WIMAX OFDMA: 100kHz C2K: Automatically calculated PN: Automatically calculated GSM/EDGE: Automatically calculated TD-SCDMA: Automatically calculated 1xEVDO: 30kHz DVB-T/H: 3.9kHz DTMB: 3.9kHz
State Saved	Saved in instrument state.
Min	1.0 Hz
Max	8.0 MHz
Instrument S/W Revision	Prior to A.02.00

Video BW

Changes the analyzer post-detection filter.

Key Path	BW
Mode	All except SA and BASIC
Remote Command	[:SENSe]:MONitor:BANDwidth:VIDeo <bandwidth> [:SENSe]:MONitor:BANDwidth:VIDeo? [:SENSe]:MONitor:BANDwidth:VIDeo:AUTO ON OFF 1 0 [:SENSe]:MONitor:BANDwidth:VIDeo:AUTO?
Example	MON:BAND:VID 10 MHz MON:BAND:VID? MON:BAND:VID:AUTO OFF MON:BAND:VID:AUTO?
Preset	WCDMA: Automatically calculated WIMAX OFDMA: 1MHz C2K: Automatically calculated PN: Automatically calculated GSM/EDGE: Automatically calculated TD-SCDMA: Automatically calculated 1xEVDO: 300kHz DVB-T/H: 39kHz DTMB: 39kHz
State Saved	Saved in instrument state.
Min	1 Hz
Max	50 MHz
Instrument S/W Revision	Prior to A.02.00

VBW:3dB RBW

Selects the ratio between the video bandwidth and the equivalent 3 dB resolution bandwidth to be used for setting the VBW when VBW is in Auto.

Key Path	BW
Mode	All except SA and BASIC

Remote Command	<pre>[:SENSE]:MONitor:BANDwidth:VIDeo:RATio <real> [:SENSE]:MONitor:BANDwidth:VIDeo:RATio? [:SENSE]:MONitor:BANDwidth:VIDeo:RATio:AUTO OFF ON 0 1 [:SENSE]:MONitor:BANDwidth:VIDeo:RATio:AUTO?</pre>
Example	<pre>MON:BAND:VID:RAT 2 MON:BAND:VID:RAT? MON:BAND:VID:RAT:AUTO 0 MON:BAND:VID:RAT:AUTO?</pre>
Preset	<pre>1 ON</pre>
State Saved	Saved in instrument state.
Min	0.00001
Max	3000000
Instrument S/W Revision	Prior to A.02.00

Span:3dB RBW

Selects the ratio between span and resolution bandwidth.

The default setting is Auto with a Span:3 dB RBW ratio of 106:1. You can manually change this ratio by pressing the key, entering a new value, and pressing Enter.

Key Path	BW
Mode	All except SA and BASIC
Remote Command	<pre>[:SENSE]:MONitor:FREQuency:SPAN:BANDwidth[:RESolution]: RATio <integer> [:SENSE]:MONitor:FREQuency:SPAN:BANDwidth[:RESolution]: RATio? [:SENSE]:MONitor:FREQuency:SPAN:BANDwidth[:RESolution]: RATio:AUTO OFF ON 0 1 [:SENSE]:MONitor:FREQuency:SPAN:BANDwidth[:RESolution]: RATio:AUTO?</pre>
Example	<pre>MON:FREQ:SPAN:BAND:RAT 200 MON:FREQ:SPAN:BAND:RAT? MON:FREQ:SPAN:BAND:RAT:AUTO ON MON:FREQ:SPAN:BAND:RAT:AUTO?</pre>
Preset	<pre>106 ON</pre>

Monitor Spectrum Measurement BW

State Saved	Saved in instrument state.
Min	2
Max	10000
Instrument S/W Revision	Prior to A.02.00

Cont

See “[Cont \(Continuous Measurement/Sweep\)](#)” on page 1059 in the section "Common Measurement Functions" for more information.

FREQ Channel

See “[Frequency/Channel](#)” on page 1061 in the section “Common Measurement Functions” for more information.

Input/Output

See “[Input/Output](#)” on page 1065 in the section "Common Measurement Functions" for more information.

Marker

Accesses a menu that enables you to select, set up and control the markers for the current measurement.

See the "Marker Functions" section for more information

Key Path	Front-panel key
Instrument S/W Revision	Prior to A.02.00

Select Marker

Displays 12 markers available for selection.

Key Path	Marker
Instrument S/W Revision	Prior to A.02.00

Marker Type

Sets the marker control mode to **Normal**, **Delta** or **Off**. If the selected marker is Off, pressing Marker sets it to Normal and places a single marker at the center of the display. At the same time, **Marker X Axis Value** appears on the Active Function area.

Key Path	Marker
Mode	All except SA and BASIC
Remote Command	:CALCulate:MONitor:MARKer[1] 2 3 4 5 6 7 8 9 10 11 12:MODE POSition DELTA OFF :CALCulate:MONitor:MARKer[1] 2 3 4 5 6 7 8 9 10 11 12:MODE?
Example	CALC:MON:MARK:MODE POS CALC:MON:MARK:MODE?
Notes	If the selected marker is Off, pressing Marker sets it to Normal and places it at the center of the screen on the trace determined by the Marker Trace rules. At the same time, Marker X Axis Value appears on the Active Function area. Default Active Function: the active function for the selected marker's current control mode. If the current control mode is Off, there is no active function and the active function is turned off. Active Function Display: the marker X axis value entered in the active function area displays the marker value to its full entered precision.
Preset	OFF
State Saved	Saved in instrument state.

Range	Normal Delta Off
Instrument S/W Revision	Prior to A.02.00

Marker X Axis Value (Remote Command only)

Sets the marker X Axis value in the current marker X Axis Scale unit. It has no effect if the control mode is **Off**, but is the SCPI equivalent of entering an X value if the control mode is **Normal** or **Delta**.

Mode	All except SA and BASIC
Remote Command	:CALCulate:MONitor:MARKer[1] 2 3 4 5 6 7 8 9 10 11 12:X <freq> :CALCulate:MONitor:MARKer[1] 2 3 4 5 6 7 8 9 10 11 12:X ?
Example	CALC:MON:MARK3:X 0 CALC:MON:MARK3:X?
Notes	If no suffix is sent, uses the fundamental units for the current marker X Axis Scale. If a suffix is sent that does not match the current marker X Axis Scale unit, an error “Invalid suffix” is generated. The query returns the marker’s absolute X Axis value if the control mode is Normal , or the offset from the marker’s reference marker if the control mode is Delta . The query is returned in the fundamental units for the current marker X Axis scale: Hz for Frequency and Inverse Time , seconds for Period and Time . If the marker is Off the response is not a number.
Preset	After a preset, all markers are turned OFF, so Marker X Axis Value query returns a not a number (NAN).
State Saved	No
Min	-9.9E+37
Max	9.9E+37
Instrument S/W Revision	Prior to A.02.00

Marker X Axis Position (Remote Command only)

Sets the marker X position in trace points. It has no effect if the control mode is **Off**, but is the SCPI equivalent of entering a value if the control mode is **Normal** or **Delta** – except in trace points rather than X Axis Scale units. The entered value is immediately translated into the current X Axis Scale units for setting the value of the marker.

Mode	All except SA and BASIC
Remote Command	:CALCulate:MONitor:MARKer[1] 2 3 4 5 6 7 8 9 10 11 12:X :POSition <real> :CALCulate:MONitor:MARKer[1] 2 3 4 5 6 7 8 9 10 11 12:X :POSition?

Monitor Spectrum Measurement Marker

Example	CALC:MON:MARK:X:POS 0 CALC:MON:MARK:X:POS?
Notes	The query returns the marker's absolute X Axis value in trace points if the control mode is Normal , or the offset from the marker's reference marker in trace points if the control mode is Delta . The value is returned as a real number, not an integer, corresponding to the translation from X Axis Scale units to trace points. If the marker is Off the response is not a number.
Preset	After a preset, all markers are turned OFF, so Marker X Axis Value query returns a not a number (NAN).
State Saved	No
Min	-9.9E+37
Max	9.9E+37
Instrument S/W Revision	Prior to A.02.00

Marker Y Axis Value (Remote Command only)

Returns the marker Y Axis value in the current marker.

Mode	All except SA and BASIC
Remote Command	:CALCulate:MONitor:MARKer[1] 2 3 4 5 6 7 8 9 10 11 12:Y? ?
Example	CALC:MON:MARK11:Y?
Preset	Result dependant on markers setup and signal source
Instrument S/W Revision	Prior to A.02.00

Properties

Accesses a menu that enables you to select the active marker, the reference marker and the trace for the current measurement.

Key Path	Marker
Instrument S/W Revision	Prior to A.02.00

Select Marker

Displays 12 markers available for selection.

Key Path	Marker
Instrument S/W Revision	Prior to A.02.00

Relative To

Selects the desired marker. The selected marker is relative to its reference marker

Key Path	Marker, Properties
Mode	All except SA and BASIC
Remote Command	:CALCulate:MONitor:MARKer[1] 2 3 4 5 6 7 8 9 10 11 12:REFerence <integer> :CALCulate:MONitor:MARKer[1] 2 3 4 5 6 7 8 9 10 11 12:REFerence?
Example	CALC:MON:MARK:REF 1 CALC:MON:MARK:REF?
Notes	A marker cannot be relative to itself so that choice is grayed out, and if sent from SCPI generates error -221: "Settings conflict; marker cannot be relative to itself." When queried a single value is returned (the specified marker number's relative marker).
Preset	2 3 4 5 6 7 8 9 10 11 12 1
State Saved	Saved in instrument state.
Min	1
Max	12
Instrument S/W Revision	Prior to A.02.00

Marker Trace

Assigns the specified marker to the designated trace.

Key Path	Marker, Properties
Mode	All except SA and BASIC
Remote Command	:CALCulate:MONitor:MARKer[1] 2 3 4 5 6 7 8 9 10 11 12:TRACe <integer> :CALCulate:MONitor:MARKer[1] 2 3 4 5 6 7 8 9 10 11 12:TRACe?
Example	CALC:MON:MARK:TRAC 1 CALC:MON:MARK:TRAC?
Preset	1
State Saved	Saved in instrument state.
Min	1
Max	3

Instrument S/W Revision Prior to A.02.00

Couple Markers

When this function is true, moving any marker causes an equal X Axis movement of every other marker which is not **Off**. By “equal X Axis movement” we mean that we preserve the difference between each marker’s X Axis value (in the fundamental x-axis units of the trace that marker is on) and the X Axis value of the marker being moved (in the same fundamental x-axis units).

Key Path	Marker
Mode	All except SA and BASIC
Remote Command	:CALCulate:MONitor:MARKer:COUPle[:STATe] ON OFF 1 0 :CALCulate:MONitor:MARKer:COUPle[:STATe]?
Example	CALC:MON:MARK:COUP ON CALC:MON:MARK:COUP?
Preset	OFF
State Saved	Saved in instrument state.
Range	On Off
Instrument S/W Revision	Prior to A.02.00

All Markers Off

Turns off all markers on the current measurement.

Key Path	Marker
Mode	All except SA and BASIC
Remote Command	:CALCulate:MONitor:MARKer:AOFF
Example	CALC:MON:MARK:AOFF
Instrument S/W Revision	Prior to A.02.00

Marker Function

Accesses special marker functions such as marker noise, and power in a specified bandwidth or time interval.

Key Path	Front-panel key
Instrument S/W Revision	Prior to A.02.00

Select Marker

Selects one of the 12 available markers.

Key Path	Marker Function
Instrument S/W Revision	Prior to A.02.00

Marker Function Type

Sets the marker control function type to, Marker Noise, Band/Interval Power, Band Interval Density, or Marker Function Off.

Key Path	Marker Function
Mode	All except SA and BASIC
Remote Command	:CALCulate:MONitor:MARKer[1] 2 3 4 5 6 7 8 9 10 11 12:F UNCTION NOISe BPOWer BDENSity OFF :CALCulate:MONitor:MARKer[1] 2 3 4 5 6 7 8 9 10 11 12:F UNCTION?
Example	CALC:MON:MARK:FUNC NOIS CALC:MON:MARK:FUNC?
Preset	OFF
State Saved	Saved in instrument state.
Range	Marker Noise Band/Interval Power Band Interval Density Marker Function Off
Instrument S/W Revision	Prior to A.02.00

Band Adjust

Accesses a menu that enables you to set the frequency span width and the left and right edge, or time values, for the band or interval of the selected marker.

Key Path	Marker Function
----------	------------------------

Monitor Spectrum Measurement Marker Function

Instrument S/W Revision Prior to A.02.00

Band/Interval Span for Frequency Domain

Sets the width of the frequency span for the selected marker.

Key Path	Marker Function
Mode	All except SA and BASIC
Remote Command	:CALCulate:MONitor:MARKer[1] 2 3 4 5 6 7 8 9 10 11 12:F UNcTion:BAND:SPAN <freq> :CALCulate:MONitor:MARKer[1] 2 3 4 5 6 7 8 9 10 11 12:F UNcTion:BAND:SPAN?
Example	CALC:MON:MARK12:FUNC:BAND:SPAN 20 MHz CALC:MON:MARK12:FUNC:BAND:SPAN?
Dependencies/Couplings	Changing the Band/Interval Span necessarily changes the Band/Interval Left and Band/Interval Right values.
Preset	Depends on X axis range of selected Trace.
State Saved	Saved in instrument state.
Min	-9.9E+37
Max	9.9E+37
Instrument S/W Revision	Prior to A.02.00

Band/Interval Left for Frequency Domain

Sets the left edge frequency or time value for the band of the selected marker.

Key Path	Marker Function
Mode	All except SA and BASIC
Remote Command	:CALCulate:MONitor:MARKer[1] 2 3 4 5 6 7 8 9 10 11 12:F UNcTion:BAND:LEFT <freq> :CALCulate:MONitor:MARKer[1] 2 3 4 5 6 7 8 9 10 11 12:F UNcTion:BAND:LEFT?
Example	CALC:MON:MARK12:FUNC:BAND:LEFT 20 GHz CALC:MON:MARK12:FUNC:BAND:LEFT?
Dependencies/Couplings	Changing the Band/Interval Left necessarily changes the Band/Interval Span and Band/Interval Right values.
Preset	Depends on X axis range of selected Trace.
State Saved	Saved in instrument state.
Min	-9.9E+37

Max 9.9E+37
 Instrument S/W Revision Prior to A.02.00

Band/Interval Right for Frequency Domain

Sets the right edge frequency or time value for the band of the selected marker.

Key Path	Marker Function
Mode	All except SA and BASIC
Remote Command	:CALCulate:MONitor:MARKer[1] 2 3 4 5 6 7 8 9 10 11 12:F UNction:BAND:RIGHT <freq> :CALCulate:MONitor:MARKer[1] 2 3 4 5 6 7 8 9 10 11 12:F UNction:BAND:RIGHT?
Example	CALC:MON:MARK12:FUNC:BAND:RIGH 20 GHz CALC:MON:MARK12:FUNC:BAND:RIGH?
Dependencies/Couplings	Changing the Band/Interval Right necessarily changes the Band/Interval Left and Band/Interval Span values
Preset	Depends on X axis range of selected Trace.
State Saved	Saved in instrument state.
Min	-9.9E+37
Max	9.9E+37
Instrument S/W Revision	Prior to A.02.00

Marker To

There is no 'Marker To' functionality supported in Monitor Spectrum. The front-panel key displays a blank menu key when pressed.

Key Path	Front-panel key
Instrument S/W Revision	Prior to A.02.00

Meas

See [“Meas” on page 1127](#) in the section "Common Measurement Functions" for more information.

Meas Setup

Displays the setup menu for the current measurement. The measurement setup parameters include the number of measurement averages used to calculate the measurement result and the averaging mode. The setup menu also includes the option to reset the measurement settings to their factory defaults.

Key Path	Front-panel key
Instrument S/W Revision	Prior to A.02.00

Avg/Hold Num

Specifies the number of measurement averages used when calculating the measurement result. The average is displayed at the end of each sweep.

After the specified number of average counts, the averaging mode (terminal control) setting determines the averaging action.

Key Path	Meas Setup
Mode	All except SA and BASIC
Remote Command	[:SENSE] :MONitor:AVERage:COUNT <integer> [:SENSe] :MONitor:AVERage:COUNT? [:SENSe] :MONitor:AVERage[:STATe] OFF ON 0 1 [:SENSe] :MONitor:AVERage[:STATe] ?
Example	MON:AVER:COUN 25 MON:AVER:COUN? MON:AVER ON MON:AVER?
Preset	10 OFF
State Saved	Saved in instrument state.
Min	1
Max	1000
Instrument S/W Revision	Prior to A.02.00

Avg Mode

Toggles the average mode between exponential (Exp) and Repeat.

Exp- continues measurement averaging, using the specified number of averages to compute each averaged value. The average is displayed at the end of each sweep.

Repeat- causes the measurement to reset the average counter each time the specified number of averages is reached.

Key Path	Meas Setup
Mode	All except SA and BASIC
Remote Command	[:SENSe]:MONitor:AVERage:TCONtrol EXPonential REPEAT [:SENSe]:MONitor:AVERage:TCONtrol?
Example	MON:AVER:TCON EXP MON:AVER:TCON?
Preset	EXPonential
State Saved	Saved in instrument state.
Range	ExpRepeat
Instrument S/W Revision	Prior to A.02.00

Meas Preset

Restores all the measurement parameters to their default values.

Key Path	Meas Setup
Mode	All except SA and BASIC
Remote Command	:CONFigure:MONitor
Example	CONF:MON
Instrument S/W Revision	Prior to A.02.00

Mode

See “[Mode](#)” on page 1145 in the section "Common Measurement Functions" for more information.

Mode Setup

See “[Mode Setup](#)” on page 1159 in the section "Common Measurement Functions" for more information.

Peak Search

There is no 'Peak Search' functionality supported in Monitor Spectrum. The front-panel key displays a blank menu key when pressed.

Key Path	Front-panel key
Instrument S/W Revision	Prior to A.02.00

Recall

See [“Recall” on page 1179](#) in the section "Common Measurement Functions" for more information.

Restart

See “[Restart](#)” on page 1201 in the section "Common Measurement Functions" for more information.

Save

See “[Save](#)” on page 1203 in the section "Common Measurement Functions" for more information.

Single

See “[Single \(Single Measurement/Sweep\)](#)” on page 1229 in the section "Common Measurement Functions" for more information.

Source

See “[Source](#)” on page 1231 in the section "Common Measurement Functions" for more information.

Span X Scale

Accesses a menu of functions that enable you to set the horizontal scale parameters.

Key Path	Front-panel key
Instrument S/W Revision	Prior to A.02.00

Span

Changes the frequency range symmetrically about the center frequency.

Key Path	Span X Scale
Mode	All except SA, BASIC
Remote Command	[:SENSE] :MONitor:FREQuency:SPAN <freq> [:SENSE] :MONitor:FREQuency:SPAN?
Example	MON:FREQ:SPAN 1 MHz MON:FREQ:SPAN?
Dependencies/Couplings	Changing the span causes the resolution bandwidth to change automatically, and affects data acquisition time.
Preset	WCDMA: 10.0 MHz WIMAX OFDMA: 50.0 MHz C2K: 2.5MHz PN: 1.0 MHz GSM/EDGE: 1.0 MHz TD-SCDMA: 3.2 MHz 1xEVDO: 2.0MHz DVB-T/H: 10.0MHz DTMB: 10.0MHz
State Saved	Saved in instrument state.
Min	10 Hz
Max	Hardware Dependent: Option 503 = 3.7 GHz Option 507 = 7.1GHz Option 508 = 8.5 GHz Option 513 = 13.8 GHz Option 526 = 27.0 GHz

Instrument S/W Revision Prior to A.02.00

Full Span

Changes the Span to show the full frequency range of the analyzer.

Key Path	Span X Scale
Mode	All except SA and BASIC
Remote Command	[:SENSE] :MONitor :FREQuency :SPAN :FULL
Example	MON:FREQ:SPAN:FULL
Dependencies/Couplings	Sets the span to the full frequency range, and adjusts the center frequency accordingly.
Instrument S/W Revision	Prior to A.02.00

Last Span

Changes the measurement span to the span setting of the previous measurement. If there is no existing previous span value, then the span remains unchanged.

Key Path	Span X Scale
Mode	All except SA and BASIC
Remote Command	[:SENSE] :MONitor :FREQuency :SPAN :PREVIOUS
Example	MON:FREQ:SPAN:PREV
Dependencies/Couplings	Selecting last span changes the measurement span value.
Instrument S/W Revision	Prior to A.02.00

Sweep/Control

Access a menu of functions that enable you to set up and control the sweep time for the current measurement

Key Path	Front-panel key
Instrument S/W Revision	Prior to A.02.00

Sweep Time

Selects the length of time in which the spectrum analyzer sweeps the displayed frequency span. Additional overhead time is required by the analyzer. It impacts the sweep rate, but is not calculated as part of the sweep time. Reducing the sweep time increases the rate of sweeps.

Key Path	Sweep/Control
Mode	All except SA and BASIC
Remote Command	[:SENSe]:MONitor:SWEep:TIME <time> [:SENSe]:MONitor:SWEep:TIME? [:SENSe]:MONitor:SWEep:TIME:AUTO OFF ON 0 1 [:SENSe]:MONitor:SWEep:TIME:AUTO?
Example	MON:SWE:TIME 100 ms MON:SWE:TIME? MON:SWE:TIME:AUTO ON MON:SWE:TIME:AUTO?
Dependencies/Couplings	When the user manually changes the Sweep Time, this set automatically goes to 'Man'.
Preset	Automatically Calculated
State Saved	Saved in instrument state.
MIN/MAX/DEF Support	Yes
Min	1 ms
Max	4000 s
Instrument S/W Revision	Prior to A.02.00

Pause

Pauses a measurement after the current data acquisition is complete. When Paused, the label on the key changes to Resume. Pressing Resume continues the measurement at the point where it had been paused.

See “Pause/Resume” on page 1236 under Sweep/Control in the "Common Measurement Functions" section for more information.

Key Path	Sweep/Control
Instrument S/W Revision	Prior to A.02.00

Gate

Accesses a menu that enables you to control the gating function .

The Gate functionality is used to view signals best viewed by qualifying them with other events.

See “Gate ” on page 1236 in “common Measurement Functions” for more details.

Key Path	Sweep/Control
Instrument S/W Revision	Prior to A.02.00

Points

Sets the number of points per sweep. The resolution of setting the sweep time depends on the number of points selected. If Preset is selected, the number of points per sweep defaults to 1001. The current value of points is displayed parenthetically, next to the sweep time in the lower right corner of the display.

Key Path	Sweep/Control
Mode	All except SA and BASIC
Remote Command	[:SENSE]:MONitor:SWEep:POINts <integer> [:SENSE]:MONitor:SWEep:POINts?
Example	:MON:SWE:POIN 1000 :MON:SWE:POIN?
Dependencies/Couplings	Whenever the number of sweep points changes, the sweep time is re-quantized.
Preset	1001
State Saved	Saved in instrument state.
Range	1 to 20001
Instrument S/W Revision	Prior to A.02.00

Trace/Detector

Accesses a menu that enables you to control the display, storage, detection and manipulation of trace data. Each trace is comprised of a series of data points in which X and Y axis information is stored. The analyzer updates the information for the active trace with each sweep of the current measurement.

Key Path	Front-panel key
Instrument S/W Revision	Prior to A.02.00

Select Trace

Allows you to select which trace you want to use for the current measurement. You can select one of three traces. Monitor Spectrum supports 3 traces, numbered 1 through 3.

Key Path	Trace/Detector
Mode	All except SA and BASIC
Preset	Trace 1
State Saved	The number of the selected trace is saved in Instrument State
Instrument S/W Revision	Prior to A.02.00

Trace Type

Allows you to select the type of trace you want to you use for the current measurement. You can assign a trace type to one of the three available traces.

The first page of this menu contains a 1-of-N selection of the trace type (**Clear Write, Average, Max Hold, Min Hold**) for the selected trace.

Key Path	Trace/Detector
Mode	All except SA and BASIC
Remote Command	:TRACe[1] 2 3:MONitor:TYPE WRITe AVERAge MAXHold MINHold :TRACe[1] 2 3:MONitor:TYPE?
Example	TRAC:MON:TYPE WRIT TRAC:MON:TYPE?
Notes	WRITe = Clear Write AVERAge = Average MAXHold = Maximum Hold MINHold = Minimum Hold

Preset	WRITE
State Saved	Saved in instrument state.
Range	WRITE AVERage MAXHold MINHold for traces 1 through 3
Instrument S/W Revision	Prior to A.02.00

Update

Toggles a trace state between Update and Off. The Off selection makes the trace inactive (or a stored trace). This does not affect whether the trace is visible or not. Use the Display Show/Blank function to change the trace visibility.

Key Path	Trace/Detector
Mode	All except SA and BASIC
Remote Command	:TRACe[1] 2 3:MONitor:UPDate[:STATE] ON OFF 0 1 :TRACe[1] 2 3:MONitor:UPDate[:STATE]?
Example	TRAC3:MON:UPD OFF TRAC3:MON:UPD?
Preset	ON
State Saved	Saved in instrument state.
Range	On Off(View)
Instrument S/W Revision	Prior to A.02.00

Display

Controls the visibility of a trace. In **Blank**, traces do not display nor appear on printouts but are otherwise unaffected. They may be queried and markers may be placed on them

Key Path	Trace/Detector
Mode	All except SA and BASIC
Remote Command	:TRACe[1] 2 3:MONitor:DISPlay[:STATE] ON OFF 0 1 :TRACe[1] 2 3:MONitor:DISPlay[:STATE]?
Example	TRAC:MON:DISP ON TRAC:MON:DISP?
Preset	ON OFF OFF
State Saved	Saved in instrument state.
Range	Show Blank
Instrument S/W Revision	Prior to A.02.00

Detector

Accesses a menu of functions that enable you to control the detectors for the current measurement. The following choices are available:

Auto — the detector selected depends on marker functions, trace functions, average type, and the trace averaging function.

- Normal — the detector determines the peak of the CW-like signals, and it yields alternating maximums and minimums of noise-like signals. This is also referred to as Rosenfell detection.
- Average — the detector determines the average of the signal within the sweep points. The averaging method depends upon the Average Type selection (voltage, power or log scales).
- Peak — the detector determines the maximum of the signal within the sweep points.
- Sample — the detector indicates the instantaneous level of the signal at the center of the sweep points represented by each display point.
- Negative Peak — the detector determines the minimum of the signal within the sweep points.

In swept analysis, the time interval of the data collection for the display sweep points also represents a frequency interval. In FFT analysis, the sweep points represent just a frequency interval. The detector determines the relationship between the spectrum computed by the FFT and the single data point displayed for the sweep points.

Key Path	Trace/Detector
Mode	All except SA and BASIC
Remote Command	[:SENSe] :MONitor :DETector :TRACe AVERage NEGative NORMal POSitive SAMPlE [:SENSe] :MONitor :DETector :TRACe?
Example	MON:DET:TRAC NORM MON:DET:TRAC?

Notes	The query returns a name that corresponds to the detector type as shown below. String Returned Definition NORM Normal AVER Average POS Peak SAMP Sample NEG Negative Peak
Dependencies/Couplings	When the Detector choice is Auto, the detector selected depends on average type.
Preset	NORMal
State Saved	Saved in instrument state.
Range	Normal Average(RMS) Peak Sample Negative Peak
Instrument S/W Revision	Prior to A.02.00

Auto

Sets the detector for the currently selected trace to Auto. When the detector choice is Auto, the analyzer selects the detector. The selected detector depends on marker functions, trace functions, and trace averaging functions for the current measurement.

Key Path	Trace/Detector Trace/Detector, Detector
Mode	All except SA and BASIC
Remote Command	[:SENSE] :MONitor :DETECTOR :AUTO ON OFF 1 0 [:SENSE] :MONitor :DETECTOR :AUTO ?
Example	MON:DET:AUTO OFF MON:DET:AUTO?
Dependencies/Couplings	When the Detector choice is Auto, the detector selected depends on average state and trace type.
Preset	ON

Monitor Spectrum Measurement Trace/Detector

State Saved	Saved in instrument state.
Range	Auto Man
Instrument S/W Revision	Prior to A.02.00

Clear Trace

Clears the selected trace from the display.

Key Path	Trace/Detector
Mode	All except SA and BASIC
Remote Command	:TRACe:MONitor:CLEAr [TRACE1] TRACE2 TRACE3
Example	TRAC:MON:CLE
Instrument S/W Revision	Prior to A.02.00
Mode	All except SA and BASIC
Remote Command	:DISPlay:MONitor:VIEW:WINDow:TRACe[1] 2 3 :CLEAr
Example	DISP:MON:VIEW:WIND:TRAC:CLE
Instrument S/W Revision	Prior to A.02.00

Clear All Traces

Clears all traces from the display.

Key Path	Trace/Detector
Mode	All except SA and BASIC
Remote Command	:TRACe:MONitor:CLEAr:ALL
Example	TRAC:MON:CLE:ALL
Instrument S/W Revision	Prior to A.02.00

View/Display

Accesses a menu of functions that enable you to control certain functions related to the display of the analyzer.

There is a single trace view for this measurement.

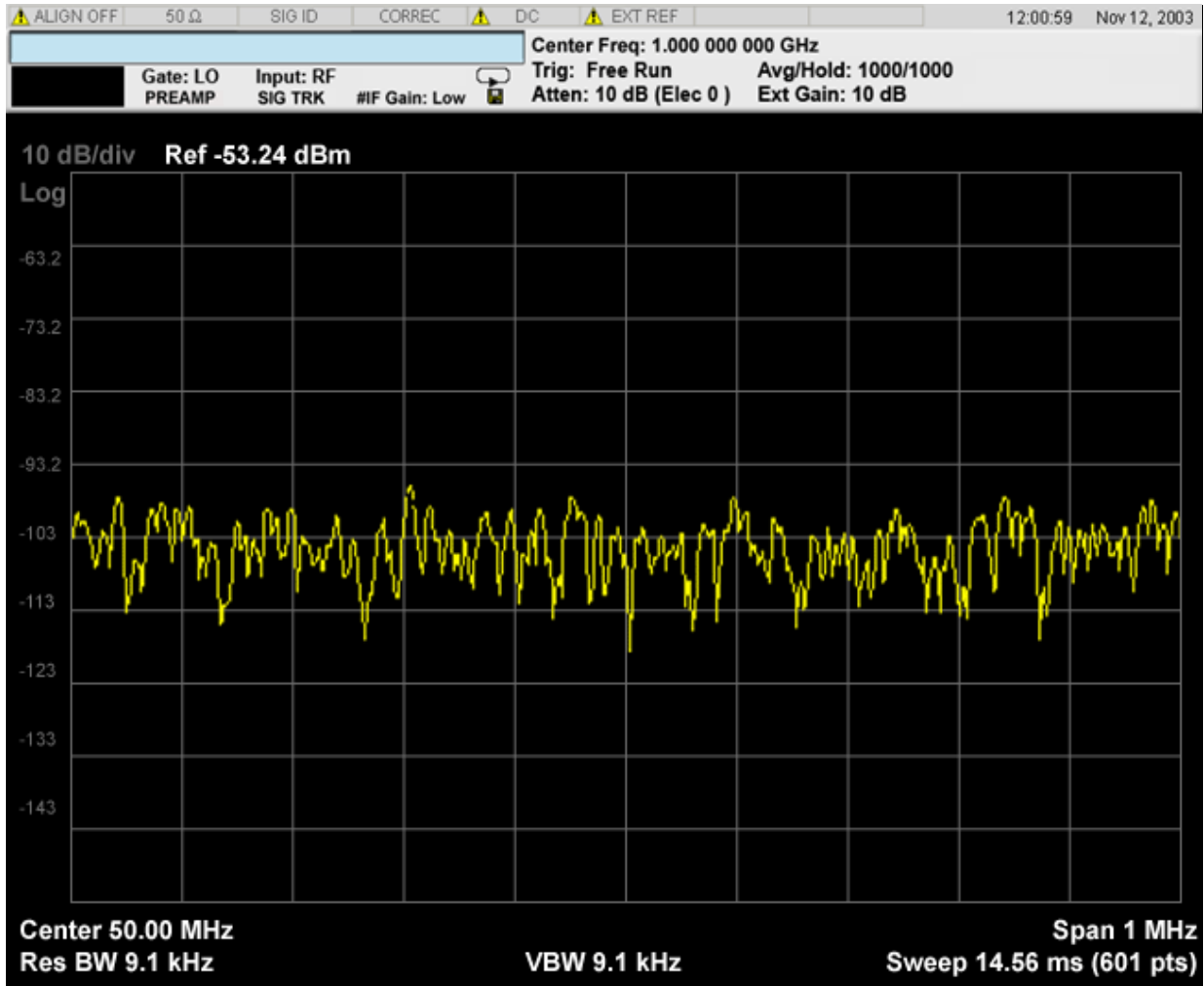

When the mode is CDMA1xEVDO, the view will be like

Monitor Spectrum Measurement View/Display

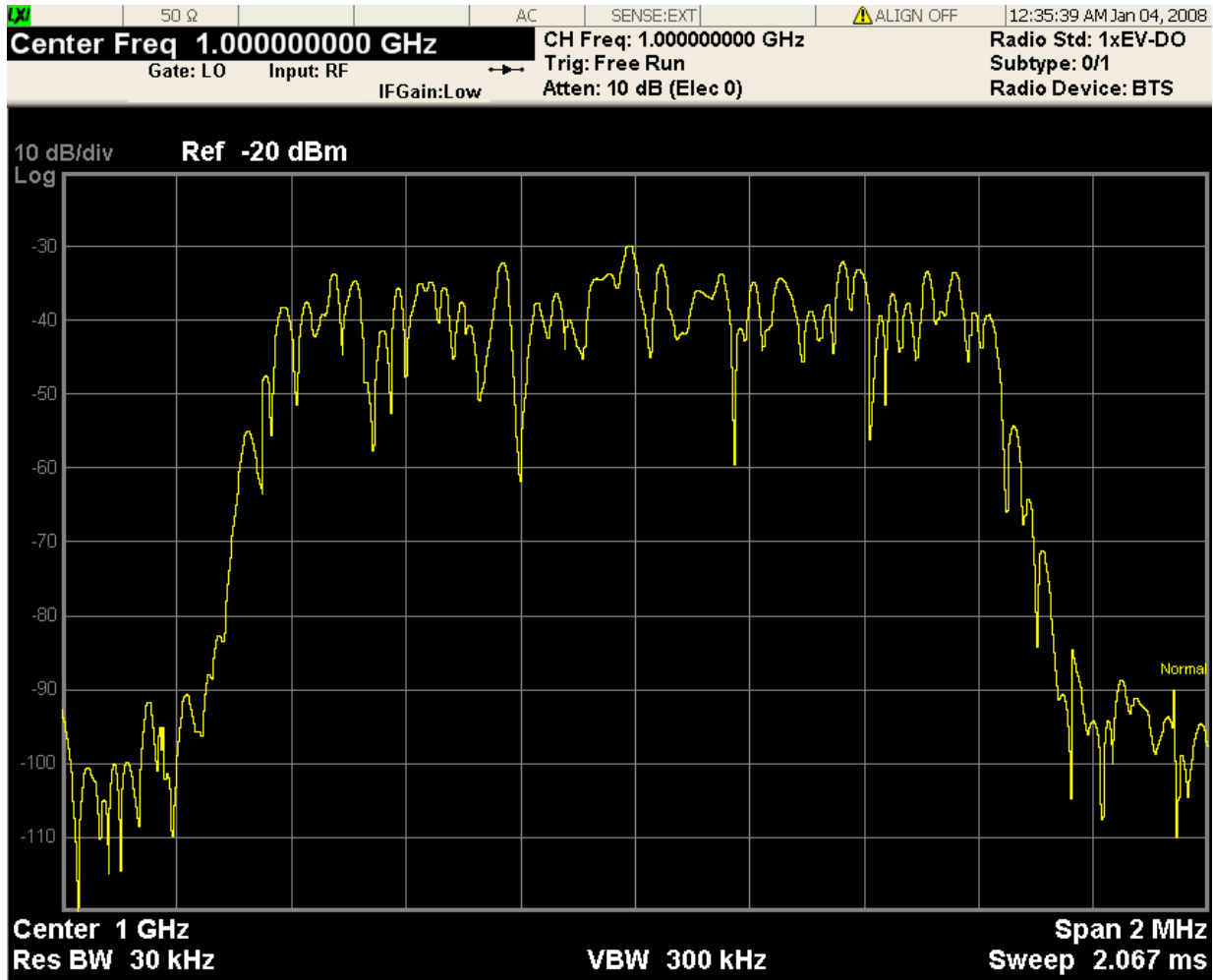

The measurement has no results, but has a number of features that make it flexible and simple to use.

Key Path	Front-panel key
Instrument S/W Revision	Prior to A.02.00

Display

Accesses a menu of functions that enable you to set the display parameters.

See “[Display](#)” on page 1307 in the "Common Measurement Functions" section for more information.

Key Path	View/Display
Instrument S/W Revision	Prior to A.02.00

The key and command descriptions in this section describe functions that operate the same in multiple measurements and/or modes. This section is a library of functions that is referenced by many measurements and modes

To find the exact description and parameters for functions in a specific measurement, always look in the measurement section of this documentation. Pressing the front-panel key or softkey and then pressing the green Help key also provides the correct information.

NOTE

If you want to print the documentation, be sure to select this section and the measurement of interest to ensure having all the information you need. See [“Printing Acrobat Files” on page 111](#) for further instructions about printing.

Amplitude Y Scale (AMPTD Y Scale)

Some Amplitude features are common across multiple Modes and Measurements. These common features are described in this section. See the Measurement description for information on features that are specific to that measurement.

The Amplitude key activates the Amplitude menu and selects Reference Level as the active function.

Key Path	Front-panel key
Instrument S/W Revision	Prior to A.02.00

Attenuation

This menu controls both the electrical and mechanical attenuators and their interactions. All parameters in the Attenuation menus are Meas Global, meaning they are common to all the measurements and are unaffected by Meas Preset.

Dependencies/Couplings	In measurements which support the I/Q inputs, this key is unavailable when I/Q is the selected input, and is replaced by the Range key in that case.
Key Path	AMPTD Y Scale
Readback Line	Contains a summary in [] brackets of the total attenuation from the menu below, which is the current Total (Elec + Mech) attenuation. Note that when in "Pre-Adjust for Min Clip" this value can change at the start of every measurement.
Instrument S/W Revision	Prior to A.02.00

Mech Atten Auto/Man

You can modify the mechanical attenuation applied to the RF input signal path. This value is normally auto coupled to the Ref Level, the Internal Preamplifier Gain, any External Gain that is entered, and the Max Mixer Level, as described in the table below. However, when the electrical attenuator is enabled, there is no Auto/Man functionality for the mechanical attenuator, and the third line of the key disappears. The Auto/Man state of the key is remembered and restored when the electrical attenuator is once again disabled.

Some measurement applications have functionality that can pre-adjust the input signal for minimum clipping. That is, it attenuates the input so it does not over-drive the analyzer. When this functionality is available, the Auto/Man selection is not available.

Remote Command:	[:SENSE]:POWER[:RF]:ATTenuation <rel_ampl>
	[:SENSE]:POWER[:RF]:ATTenuation?
	[:SENSE]:POWER[:RF]:ATTenuation:AUTO OFF ON 0 1
	[:SENSE]:POWER[:RF]:ATTenuation:AUTO?

Amplitude Y Scale (AMPTD Y Scale)

Example:	POW:ATT 20 Sets the attenuator to manual mode, and sets the value to 20 dB.
Dependencies/Couplings:	<p>When the electrical attenuator is enabled, the mechanical attenuator has no auto setting and Auto/Man line on the key disappears. The state of Auto/Man is remembered and restored when the electrical attenuator is once again disabled. If it is restored to man, the mechanical attenuation is set to the sum of the current values of mechanical and electrical attenuation, but if it is restored to Auto it recouples according to the Couplings, below.</p> <p>When the Input Attenuator is in 'auto', it uses the following algorithm to determine a value:</p> $\text{Atten} = \text{ReferenceLevel} + \text{PreAmpGain} + \text{ExternalGain} - \text{RefLevelOffset} - \text{MaxMixerLevel} + \text{IF Gain}.$ <p>Limit this value to be between 6 and 70 dB for MXA (or 60 dB for EXA). No value below 6 dB can ever be chosen by Auto.</p> <p>The resulting value should be rounded up to the largest value possible given the attenuation step setting. That is, 50.01 dB would change to 60 dB (for a 10 dB attenuation step).</p> <p>The "IF Gain" term in the equation above is either 0 dB or +10 dB, depending in a fairly complex fashion on the settings of FFT IF Gain, Swept IF Gain, max Ref Level and the Auto/Man setting of Mech Atten.</p>
Preset:	Auto
State Saved:	Saved in State
Min:	0 dB The mechanical attenuation cannot be decreased below 6 dB with the knob or step keys. To get to a value below 6 dB it has to be directly entered from the keypad or via SCPI. This protects from adjusting the attenuation to a dangerously small value which can put the instrument at risk of damage to input circuitry. However, if the current mechanical attenuation is below 6 dB it can be increased with the knob and step keys, but not decreased.
Max:	EXA: 60 dB MXA: 70 dB
Key Path:	AMPTD Y Scale, Attenuation
Instrument S/W Revision:	Prior to A.02.00

Enable Elec Atten

You can enable or disable the Electrical Attenuator. The Electrical Attenuator offers no significant advantage over the Mechanical Attenuator for front-panel operation. Therefore it is assumed you will use the Mechanical Attenuator when operating the analyzer from the front-panel.

The electronic attenuator is unavailable above 3.6 GHz. Therefore, if the Stop Frequency of the analyzer is > 3.6 GHz then Enable Elec Atten is grayed out. If the Elec Atten is enabled, then the Stop Freq of the analyzer is limited to 3.6 GHz, which is to say the UI start, stop, center frequency and span values are all

limited to a maximum of 3.6 GHz + Frequency Offset.

Remote Command: [:SENSE] :POWER [:RF] :EATTenuation :STATE OFF | ON | 0 | 1
 [:SENSE] :POWER [:RF] :EATTenuation :STATE?

Example: POW:EATT:STAT ON

Dependencies/Couplings: The electronic attenuator is unavailable above 3.6 GHz. Therefore, if the Stop Frequency of the analyzer is > 3.6 GHz then the Elec Atten is grayed out.

If the Internal Preamp is on, meaning it is set to Low Band or Full, the electronic attenuator is unavailable. In this case the Enable Elec Atten key will be OFF and grayed out.

If either of the above is true, if the SCPI command is sent, a generic error indicating that the electronic attenuator is unavailable will be sent.

If the Electronic Attenuator is enabled, then the Stop Freq of the analyzer is limited to 3.6 GHz and the Internal Preamp is unavailable.

Preset: OFF
 State Saved: Saved in instrument state.
 Key Path: **AMPTD Y Scale, Attenuation**
 Instrument S/W Revision: Prior to A.02.00

When the Electrical Attenuator is enabled, the Mechanical Attenuator transitions to a state in which it has no Auto function. Here are the rules for transitioning the Mechanical Attenuator:

When the Electrical Attenuator is enabled:

- The Mechanical Attenuator is initialized to 10 dB (this is its optimal performance setting). You can then set it as desired with SCPI, numeric keypad, step keys, or knob, and it behaves as it normally would in manual mode
- The Auto/Man state of Mech Atten is saved
- The Auto/Man line on the Mech Atten key disappears and the auto rules are disabled
- The Electrical Attenuator is set to 10 dB less than the previous value of the Mechanical Attenuator, within the limitation that it must stay within the range of 0 to 24 dB of attenuation.

Examples:

- Mech Atten at 20 dB. Elec Atten enabled, Mech Atten set to 10 dB, and Elect Atten set to 10 dB. New total attenuation equals value before Elec Atten enabled.
- Mech Atten at 0 dB. Elec Atten enabled, Mech Atten set to 10 dB, and Elect Atten set to 0 dB. New total attenuation does not equal value before Elec Atten enabled.

Amplitude Y Scale (AMPTD Y Scale)

- Mech Atten at 40 dB. Elec Atten enabled, Mech Atten set to 10 dB, and Elect Atten set to 24 dB. New total attenuation does not equal value before Elec Atten enabled.

When the Electrical Attenuator is disabled:

- The Elec Atten key is grayed out
- The Auto/Man state of Mech Atten is restored
- If now in Auto, Mech Atten recouples
- If now in man, Mech Atten sets to the value of total atten that existed before the Elec Atten was disabled. The resulting value should be rounded up to the smallest value possible given the Mech Atten Step setting - (That is, 57 dB would change to 58 dB when Mech Atten Step is 2 dB.)

Elec Atten

You can modify the electrical attenuation using this function

Remote Command:	<code>[:SENSe]:POWer[:RF]:EATTenuation <rel_amp></code> <code>[:SENSe]:POWer[:RF]:EATTenuation?</code>
Restriction and Notes:	Electrical Attenuation's spec is defined only when Mechanical Attenuation is 6 dB.
Dependencies/Couplings:	When Enable Elec Atten is off, Elec Atten key is grayed out.
Preset:	0 dB
State Saved:	Saved in instrument state.
Min:	0 dB
Max:	24 dB
Key Path:	AMPTD Y Scale, Attenuation
Instrument S/W Revision:	Prior to A.02.00

Adjust Atten for Min Clip

This function is similar to the "Optimize Ref Level" function in some measurements in the Agilent PSA and ESA analyzers. Its purpose is to set the combination of mechanical and electrical attenuation based on the current measured signal level so that clipping will be at a minimum.

This is a "one-time" function, that is, it executes once, when the key is pressed.

This key is grayed out in measurements that do not support this functionality. The spectrum analyzer measurement, Swept SA, does not support this functionality.

Remote Command:	<code>[:SENSe]:POWer[:RF]:RANGe:OPTimize IMMEDIATE</code>
Key Path:	AMPTD Y Scale, Attenuation
Instrument S/W Revision:	Prior to A.02.00

The algorithm to be used is as follows:

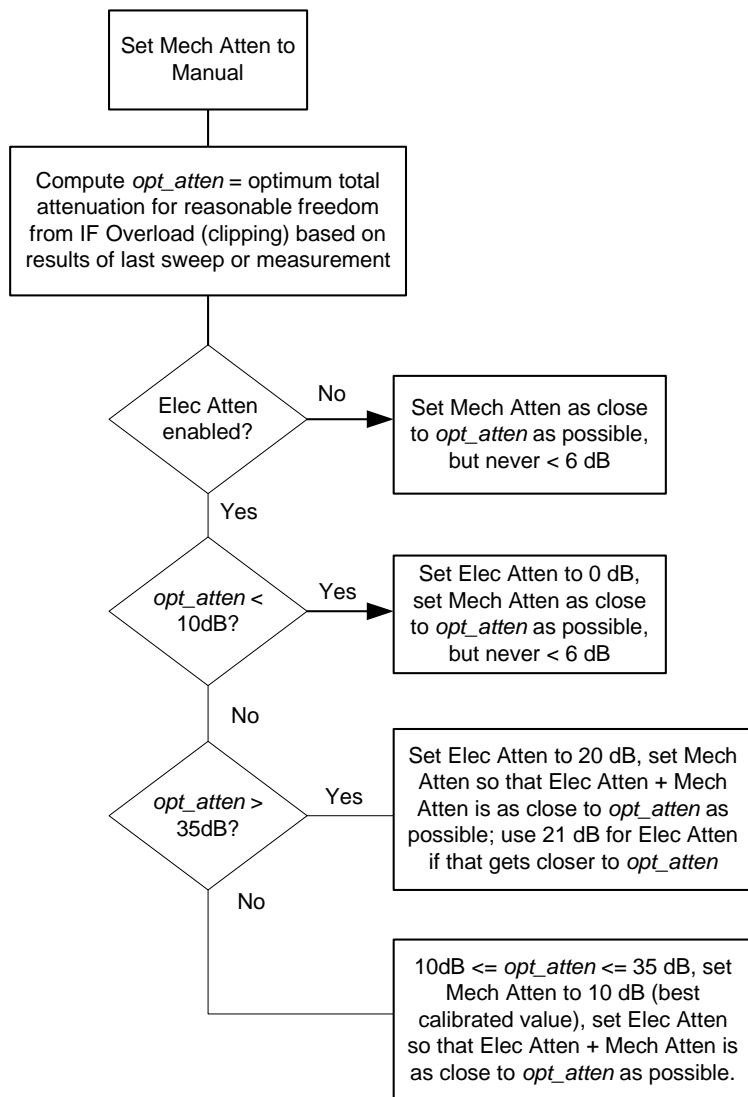

vsd04

Pre-Adjust for Min Clip

This adjustment executes each time a measurement restarts. Therefore, in Continuous, it only executes before the first measurement.

This key is grayed out in measurements that do not support this functionality. The spectrum analyzer measurement, Swept SA, does not support this functionality.

Remote Command: `[:SENSE] :POWER [:RF] :RANGE :OPTimize :ATTenuation
OFF | ELECTrical | COMBined
[:SENSe] :POWER [:RF] :RANGE :OPTimize :ATTenuation?`

State Saved: Saved in State

Key Path: **AMPTD Y Scale, Attenuation**

Amplitude Y Scale (AMPTD Y Scale)

Instrument S/W Revision: Prior to A.02.00

Remote Command: [:SENSe] :POWer [:RF] :RANGe:AUTO ON|OFF|1|0
[:SENSe] :POWer [:RF] :RANGe:AUTO?

Remote Command Notes: ON aliases to "Elec Atten Only"
OFF aliases to "Off"
The query returns true if not "Off"

Instrument S/W Revision: Prior to A.02.00

Off

Example: :POW:RANGe:OPT:ATT OFF

Key Path: **AMPTD Y Scale, Attenuation, Pre-Adjust for Min Clip**

Instrument S/W Revision: Prior to A.02.00

Elec Atten Only

Example: :POW:RANGe:OPT:ATT ELEC

Key Path: **AMPTD Y Scale, Attenuation, Pre-Adjust for Min Clip**

Instrument S/W Revision: Prior to A.02.00

Mech + Elec Atten

Example: :POW:RANGe:OPT:ATT COMB

Key Path: **AMPTD Y Scale, Attenuation, Pre-Adjust for Min Clip**

Instrument S/W Revision: Prior to A.02.00

Mech Atten Step

This controls what step size is used when making adjustments to the Input Attenuation.

Remote Command: [:SENSe] :POWer [:RF] :ATTenuation:STEP [:INCRement] 10 dB |
2 dB
[:SENSe] :POWer [:RF] :ATTenuation:STEP [:INCRement] ?

Example: POW:ATT:STEP 2

Dependencies/Couplings:	Blanked in EXA if option FSA (2 dB steps) is not present. Attempts to set it via SCPI will yield the "Option not present" error. When the attenuation step size changes, the current mechanical attenuation value is adjusted (if necessary) to be quantized to the new step size. That is, if step is set to 10 dB, mech atten is increased if necessary so it is a multiple of 10 dB
Remote Command Notes:	Note this feature works like a 1-N choice from the front panel, but it takes a specific value (in dB) when used remotely. The only valid values are 2 and 10.
Preset:	MXA: 2 dB EXA: 10 dB (2 dB with option FSA)
State Saved:	Saved in State
Key Path:	AMPTD Y Scale, Attenuation
Instrument S/W Revision:	Prior to A.02.00

Max Mixer Level

The Max Mixer Level controls the limitation on the Ref Level for a given attenuation setting, and therefore also interacts with the Auto rules for selecting the attenuation as a coupling from the reference level.

Remote Command:	[:SENSe] :POWER[:RF] :MIXer :RANGe[:UPPer] <real> [:SENSe] :POWER[:RF] :MIXer :RANGe[:UPPer] ?
Example:	POW:MIX:RANG -15 dBm
Preset:	-10 dBm
State Saved:	Saved in State
Min:	-50 dBm
Max:	-10 dBm
Key Path:	AMPTD Y Scale, Attenuation
Default Unit:	Depends on the current selected Y axis unit, see Swept SA discussion of Y Axis Unit
Instrument S/W Revision:	Prior to A.02.00

Range

This key is only available when I/Q is the selected input. It replaces the Attenuation key in that case.

Each input channel (I and Q) has four internal gain ranges. The maximum allowed voltage in each gain range is slightly more than the nominal value, so the break point between ranges is a couple millivolts

Amplitude Y Scale (AMPTD Y Scale)

higher than the nominal (setting a peak voltage of 0.502 mV will still map to the 0.5 V Peak range).

Gain Setting	Volts RMS	Volts Peak	Volts Peak - Peak	dBm (50Ω)	Break Point
0 dB	0.7071	1.0	2.0	10	n/a
6 dB	0.3536	0.5	1.0	4	0.502 V Peak
12 dB	0.1768	0.25	0.5	-2	0.252 V Peak
18 dB	0.0884	0.125	0.25	-8	0.127 V Peak

Restriction and Notes Visible only when the selected input is I/Q.

Key Path **AMPTD Y Scale**

State Saved No

Readback Text When Range is Auto, "[Auto]"
 When Range is Man and I & Q are the same, "[<range value>]"
 When Range is Man and I & Q are different:
 "[I: <I range value>
 Q: <Q range value>]"
 See I Range and Q Range for the <range value> enumeration definition.

Instrument S/W Revision Prior to A.02.00

Range Auto/Man

The Auto setting for Range will cause the range to be set based on the Y Scale settings. When Range is “Auto”, the I & Q Range are set based on the top of the Y Scale when the Y scale is in dB units (for example, power), or to the max(abs(top), abs(bottom)) when the Y scale reference is not at top of screen.

Not all measurements support Range Auto/Man. If Auto is not supported in the current measurement, this key is grayed out and shows “Man” and MAN is returned to a SCPI query; but this does NOT change the Meas Global Auto/Man for Range, so when you go to a measurement that supports Auto, it goes back to Auto if it was previously in Auto.

Remote Command [:SENSe]:VOLTage:IQ:RANGe:AUTO OFF|ON|0|1
 [:SENSe]:VOLTage:IQ:RANGe:AUTO?

Dependencies/Couplings When in Auto, both I Range and Q Range are set to the same value, computed as follows:
 Maximum absolute value is computed for the Y Scale. The top and bottom of the graph are computed based on Ref Value, Scale/Div, and Ref Position.
 Formula: YMax = max(abs(top), abs(bottom)).
 The I Range and Q Range are then set to YMax.
 If Auto is not supported, sending the SCPI command will generate an error.

Example	Put the I Range and Q Range in manual. VOLT:IQ:RANG:AUTO OFF
Key Path	AMPTD Y Scale, Range
Preset	ON
State Saved	Saved in instrument state.
Range	Auto Man
Instrument S/W Revision	Prior to A.02.00

This is an alternate form of the SCPI command to match the POWER form of the I Range and Q Range SCPI.

Remote Command:	[:SENSE] :POWER : IQ :RANGE :AUTO OFF ON 0 1 [:SENSE] :POWER : IQ :RANGE :AUTO ?
Preset:	ON
Range:	Auto Man
Remote Command Notes:	The POW:IQ:RANG:AUTO is an alternate form of the VOLT:IQ:RANG:AUTO command. This is to maintain consistency with I Range and Q Range, which support both the POWER and VOLTage forms of the command.
Example:	Put the I Range and Q Range in manual. POW:IQ:RANG:AUTO OFF
Instrument S/W Revision:	Prior to A.02.00

I Range

This is the internal gain range for the I channel when Input Path is I Only or Ind I/Q, and it is used for both the I and Q channels when Input Path is I+jQ. See [“I/Q Gain Ranges” on page 1048](#).

Remote Command	[:SENSE] :VOLTage : IQ [: I] :RANGE [:UPPER] <voltage> [:SENSE] :VOLTage : IQ [: I] :RANGE [:UPPER] ?
Dependencies/Couplings	When Q Same as I is On, the I Range value will be copied to the Q Range. Changing the value will also set Range = Man.
Remote Command Notes	The numeric entries are mapped to the smallest gain range whose break point is greater than or equal to the value, or 1 V Peak if the value is greater than 1 V.
Example	Set the I Range to 0.5 V Peak VOLT:IQ:RANG 0.5 V
Key Path	AMPTD Y Scale, Range

Amplitude Y Scale (AMPTD Y Scale)

Preset	1 V Peak
State Saved	Saved in instrument state.
Range	1 V Peak 0.5 V Peak 0.25 V Peak 0.125 V Peak
Instrument S/W Revision	Prior to A.02.00

This is an alternate form of the SCPI command to allow entry as a power.

Remote Command:	<code>[:SENSe] :POWer :IQ [: I] :RANGe [:UPPer] <amp;gt;</code> <code>[:SENSe] :POWer :IQ [: I] :RANGe [:UPPer] ?</code>
Preset:	10.0 dBm
Range:	-20 dBm to 10 dBm
Min:	-20 dBm
Max:	10 dBm
Remote Command Notes:	The POWer form of the command is provided for convenience. It maps to the same underlying gain range parameter as the VOLTage form of the command. The Reference Z (not the I channel Input Z) is used to convert the power to peak voltage, which is then used to set the I Range as with the VOLTage form of the command. The power values of the 4 range states (1V Peak, 0.5V Peak, 0.25V Peak, and 0.125V Peak) will vary with Reference Z. Here are some examples: 50Ω: 10, 4, -2, -8 75Ω: 8.2, 2.2, -3.8, -9.8 600Ω: -0.8, -6.8, -12.8, -18.9
Example:	Set the I Range to 0.5 V Peak when Reference Z is 50Ω, and to 1.0 V Peak when Reference Z is 75Ω POW:IQ:RANG 4 dBm
Instrument S/W Revision:	Prior to A.02.00

Q Range

Bring up the Q Range menu.

Key Path	AMPTD Y Scale, Range
Readback Text	Q Same as I 1 V Peak 0.5 V Peak 0.25 V Peak 0.125 V Peak When Q Same as I is On, the readback is "Q Same as I", otherwise it is the Q Range value.
Instrument S/W Revision	Prior to A.02.00

Q Same as I Many, but not all, usages require the I and Q channels have an identical setup. To simplify channel setup, the Q Same as I will cause the Q channel range to be mirrored from the I channel. That

way you only need to set up one channel (the I channel). The I channel values are copied to the Q channel, so at the time Q Same as I is "Off" the I and Q channel setups will be identical.

Remote Command	[:SENSe] :VOLTage POWer: IQ: MIRRored OFF ON 0 1 [:SENSe] :VOLTage POWer: IQ: MIRRored?
Dependencies/Couplings	When On, the I Range value is mirrored (copied) to the Q Range.
Example	Turn off the mirroring of I Range to Q Range. VOLT:IQ:MIRR OFF POW:IQ:MIRR OFF
Key Path	AMPTD Y Scale, Range, Q Range
Preset	On
State Saved	Saved in instrument state.
Range	On Off
Readback Text	"Q Same as I" when On, otherwise none.
Instrument S/W Revision	Prior to A.02.00

Q Range Value This is the internal gain range for the Q channel. See [“I/Q Gain Ranges” on page 1048](#). The Q Range only applies to Input Path Q Only and Ind I/Q. For input I+jQ the I Range determines both I and Q channel range settings.

Remote Command	[:SENSe] :VOLTage: IQ: Q: RANGE [:UPPer] <voltage> [:SENSe] :VOLTage: IQ: Q: RANGE [:UPPer]?
Dependencies/Couplings	When Q Same as I is On, the I Range value will be copied to the Q Range and the range value keys are disabled. Changing the value will also set Range = Man.
Remote Command Notes	The numeric entries are mapped to the smallest gain range whose break point is greater than or equal to the value, or 1 V Peak if the value is greater than 1 V. The Q Range is only used for Input Path Q Only and Ind I/Q. For input I+jQ the I Range determines both I and Q channel range settings.
Example	Set the Q Range to 0.5 V Peak VOLT:IQ:Q:RANG 0.5 V
Key Path	AMPTD Y Scale, Range
Preset	1 V Peak
State Saved	Saved in instrument state.
Range	1 V Peak 0.5 V Peak 0.25 V Peak 0.125 V Peak
Instrument S/W Revision	Prior to A.02.00

Amplitude Y Scale (AMPTD Y Scale)

This is an alternate form of the SCPI command to allow entry as a power.

Remote Command:	<code>[:SENSe] :POWer :IQ :Q :RANGe [:UPPer] <ampl></code> <code>[:SENSe] :POWer :IQ :Q :RANGe [:UPPer] ?</code>
Preset:	10.0 dBm
Range:	-20 dBm to 10 dBm
Min:	-20 dBm
Max:	10 dBm
Remote Command Notes:	The POWer form of the command is provided for convenience. It maps to the same underlying gain range parameter as the VOLTage form of the command. The Reference Z (not the Q channel Input Z) is used to convert the power to peak voltage, which is then used to set the Q Range as with the VOLTage form of the command. The power values of the 4 range states (1 V Peak, 0.5 V Peak, 0.25 V Peak, and 0.125 V Peak) will vary with Reference Z. Here are some examples: 50Ω: 10, 4, -2, -8 75Ω: 8.2, 2.2, -3.8, -9.8 600Ω: -0.8, -6.8, -12.8, -18.9
Example:	Will set the Q Range to 0.5 V Peak when Reference Z is 50Ω, and to 1.0 V Peak when Reference Z is 75Ω POW:IQ:Q:RANG 4 dBm
Instrument S/W Revision:	Prior to A.02.00

I/Q Gain Ranges

1 V Peak Set the channel gain state to 1 Volt Peak.

Key Path	AMPTD Y Scale, I Range Q Range
Instrument S/W Revision	Prior to A.02.00

0.5 V Peak Set the channel gain state to 1 Volt Peak.

Key Path	AMPTD Y Scale, I Range Q Range
Instrument S/W Revision	Prior to A.02.00

0.25 V Peak Set the channel gain state to 1 Volt Peak.

Key Path	AMPTD Y Scale, I Range Q Range
Instrument S/W Revision	Prior to A.02.00

0.125 V Peak Set the channel gain state to 1 Volt Peak.

Key Path	AMPTD Y Scale, I Range Q Range
Instrument S/W Revision	Prior to A.02.00

Presel Center

When this key is pressed, the centering of the preselector filter is adjusted to optimize the amplitude accuracy at the frequency of the selected marker. If the selected marker is not on when Presel Center is pressed, the analyzer will turn on the selected marker, perform a peak search, and then perform centering on the marker's center frequency. If the selected marker is already on and between the start and stop frequencies of the analyzer, the analyzer performs the preselector calibration on that marker's frequency. If the selected marker is already on, but outside the frequency range between Start Freq and Stop Freq, the analyzer will first perform a peak search, then perform centering on the marker's center frequency.

The value displayed on the **Presel Adjust** key will change to reflect the new preselector tuning (see **Presel Adjust**, below).

A number of considerations should be observed to ensure proper operation:

If the selected marker is off, the analyzer will turn on a marker, perform a peak search, and adjust the preselector using the selected marker's frequency. It uses the "highest peak" peak search method unqualified by threshold or excursion, so that there is no chance of a 'no peak found' error. It continues with that peak, even if it is the peak of just noise. Therefore, for this operation to work properly, there should be a signal on screen in a preselected range for the peak search to find.

If the selected marker is already on, the analyzer will attempt the centering at that marker's frequency. There is no preselector for signals below about 3.6 GHz, therefore if the marker is on a signal below 3.6 GHz, no centering will be attempted and an advisory message generated

When centering the preselector, *OPC will not return true until the process is complete and a subsequent measurement has completed, nor will results be returned to a READ or MEASure command. Note further that if the analyzer is in a measurement such as averaging when this happens, the act of centering the preselector will restart averaging but the first average trace will not be taken until the centering is completed.

Remote Command: [:SENSe] :POWer [:RF] :PCENter

Example: POW:PCEN

Amplitude Y Scale (AMPTD Y Scale)

- Dependencies/Couplings:
- Grayed out if microwave preselector is off (see **Input/Output, Microwave Preselector On/Off**)
 - If the selected marker's frequency is below Band 1, advisory 0.5001 is generated and no action is taken.
 - Grayed out if entirely in Band 0.
 - Blank in models that do not include a preselector, such as option 503. If the SCPI is sent in such models, it generates an error.
 - Active marker position determines where the centering will be attempted.

Remote Command Notes: Note that the rules outlined above under the key description apply for the remote command as well as the key. Hence, the result of the command is dependent on marker position, etc. Any message shown by the key press is also shown in response to the remote command.

Key Path:

AMPTD Y Scale

SCPI Status Bits/OPC
Dependencies:

The Measuring bit should remain set while this command is operating and should not go false until the subsequent sweep/measurement has completed.

Instrument S/W Revision: Prior to A.02.00

Preselector Adjust

Allows you to manually adjust the preselector filter frequency to optimize its response to the signal of interest. This function is only available when **Presel Center** is available (see **Presel Center**, above), that is, the same gray-out rules apply.

For general purpose signal analysis, using Presel Center is recommended. Centering the filter minimizes the impact of long-term preselector drift. Presel Adjust can be used instead to manually optimize the preselector. One application of manual optimization would be to peak the preselector response, which both optimizes the signal-to-noise ratio and minimizes amplitude variations due to small (short-term) preselector drifting.

Preselector Adjust is a Meas Global parameter.

Remote Command: `[:SENSe] :POWer [:RF] :PADJust <freq>`
`[:SENSe] :POWer [:RF] :PADJust?`

Example:	POW:PADJ 100KHz POW:PADJ?
Dependencies/Couplings:	<ul style="list-style-type: none"> • Grayed out if microwave preselector is off (see Input/Output, Microwave Preselector On/Off) • Grayed out if entirely in Band 0. • Blank in models that do not include a preselector, such as option 503. If the SCPI is sent in these instruments, it generates an error.
Preset:	0 MHz
State Saved:	The Presel Adjust value set by Presel Center , or by manually adjusting Presel Adjust , is not saved in Instrument State, and does not survive Preset or power cycle.
Min:	-500 MHz
Max:	500 MHz
Key Path:	AMPTD Y Scale
Default Unit:	Hz
Instrument S/W Revision:	Prior to A.02.00
Remote Command:	<pre>[:SENSE] : POWER [:RF] : PADJust : PRESelector MWAVE MMWave EXTernal [:SENSe] : POWER [:RF] : PADJust : PRESelector?</pre>
Remote Command Notes:	<pre>[:SENSe] : POWER [:RF] : PADJust : PRESelector MWAVE MMWave EXTernal</pre> <p>where: MWAVE = 3–26 GHz MMWave = 26–50 GHz EXTernal = External</p> <p>Preselector Selection - PSA had multiple preselectors, and you could select which preselector to center. Since MXA will have only one preselector, the preselector selection key will no longer be available. However, in order to provide backward compatibility, we will support the remote command.</p> <p>The command form is a NOP</p> <p>The query will return MWAVE</p>

Amplitude Y Scale (AMPTD Y Scale)

Instrument S/W Revision: Prior to A.02.00

Internal Preamp

Accesses keys that control the internal preamps. Turning on the preamp gives a better noise figure, but a poorer TOI to noise floor dynamic range. You can optimize this setting for your particular measurement.

Preamp on/off and Preamp Band are Meas Global parameters.

Remote Command: [:SENSe] :POWer [:RF] :GAIN [:STATe] OFF | ON | 0 | 1
[:SENSe] :POWer [:RF] :GAIN [:STATe] ?

Dependencies/Couplings: Preamp is not available on all hardware platforms. If the preamp is not present or is unlicensed, the key is not shown.
The preamp is not available when the electronic attenuator is enabled.

Preset: OFF

State Saved: Saved in state

Key Path: **AMPTD Y Scale**

Instrument S/W Revision: Prior to A.02.00

Remote Command: [:SENSe] :POWer [:RF] :GAIN :BAND LOW | FULL
[:SENSe] :POWer [:RF] :GAIN :BAND ?

Dependencies/Couplings: Preamp is not available on all hardware platforms. If the preamp is not present or is unlicensed, the key is not shown.
If a POW:GAIN:BAND FULL command is sent when a low band preamp is available, the preamp band parameter is to LOW instead of FULL, and an "Option not installed" message is generated.

Preset: LOW

State Saved: Saved in state

Key Path: **AMPTD Y Scale, Internal Preamp**

Instrument S/W Revision: Prior to A.02.00

Off

Turns the internal preamp off

Example: :POW:GAIN OFF

Key Path: **AMPTD Y Scale, Internal Preamp**
Readback: Off
Instrument S/W Revision: Prior to A.02.00

Low Band

Sets the internal preamp to use only the low band (0–3.6 GHz)

Example: :POW:GAIN ON
:POW:GAIN:BAND LOW

Key Path: **AMPTD Y Scale, Internal Preamp**
Readback: Low Band
Instrument S/W Revision: Prior to A.02.00

Full Range

Sets the internal preamp to use its full range. The low band (0–3.6 GHz) is supplied by the low band preamp and the frequencies above 3.6 GHz are supplied by the high band preamp.

The instrument compensates for the preamp gain(s) as it sweeps. For the value of "Int Preamp Gain" in the Ref Level equations, we assume a preamp gain of 20 dB in Low Band Preamp mode and 35 dB in Full Range preamp mode. These gain rules are not dependent on start and stop frequencies. These gains are the maximum gain of the preamp hardware; we will always have the same or less actual gain, providing clipping margin.

The frequency range of the installed (optional) preamp is displayed in square brackets on the key label. If the high band option is not installed the Full Range key does not appear.

Example: :POW:GAIN ON
:POW:GAIN:BAND FULL

Key Path: **AMPTD Y Scale, Internal Preamp**
Readback: Full Range
Instrument S/W Revision: Prior to A.02.00

Amplitude Y Scale (AMPTD Y Scale)

AUTO COUPLE

The Auto Couple feature provides a quick and convenient way to automatically couple multiple instrument settings. This helps ensure accurate measurements and optimum dynamic range. When the Auto Couple feature is activated, either from the front panel or remotely, all parameters of the current measurement which have an Auto/Manual mode are set to Auto mode and all measurement settings dependent on (or coupled to) the Auto/Man parameters are automatically adjusted for optimal performance.

However, the Auto Couple key is meas local key, so its actions are confined to the current measurement only. It does not affect other measurements in the mode, and it does not affect markers, marker functions, or trace or display attributes.

Remote Command: :COUPle ALL|NONE

Example: :COUP ALL

Remote Command Notes: :COUPle ALL puts all Auto/Man parameters in Auto mode (equivalent to pressing the **Auto Couple** key).

:COUPLE NONE puts all Auto/Man parameters in manual mode. It decouples all the coupled instrument parameters and is not recommended for making measurements.

Key Path: **Front-panel key**

Instrument S/W Revision: Prior to A.02.00

AUTO COUPLE

BW

Bandwidth features are unique to each Measurement. See the specific Measurement for more information.

The front panel key accesses keys to control measurement bandwidth settings.

Key Path	Front panel key
Instrument S/W Revision	Prior to A.02.00

BW

Cont (Continuous Measurement/Sweep)

Cont Sets the analyzer for Continuous measurement operation. The single/continuous state is Meas Global so the setting will affect all measurements. If you are Paused, pressing Cont does a Resume.

Remote Command:	:INITiate:CONTinuous OFF ON 0 1 :INITiate:CONTinuous?
Example:	:INIT:CONT 0 puts analyzer in Single measurement operation. :INIT:CONT 1 puts analyzer in Continuous measurement operation
Preset:	ON (Note that SYST:PRESet sets INIT:CONT to ON but *RST sets INIT:CONT to OFF)
State Saved:	Saved in Instrument State
Key Path:	Front-panel key
Instrument S/W Revision:	Prior to A.02.00

In Swept SA Measurement (Spectrum Analysis Mode):

The analyzer takes repetitive sweeps, averages, measurements, etc. when in Continuous mode. When the average count reaches the **Average/Hold Number** the count stops incrementing but the analyzer keeps sweeping. See the Trace/Detector section for the averaging formula used both before and after the **Average/Hold Number** is reached. The trigger condition must be met prior to each sweep. The type of trace processing for multiple sweeps, is set under the Trace/Detector key, with choices of **Trace Average, Max Hold, or Min Hold**.

In Other Measurements/Modes:

With **Avg Number** (in **Meas Setup** menu) set to **Off** or set to **On** with a value of 1, a sweep is taken after the trigger condition is met; and the analyzer continues to take new sweeps after the current sweep has completed and the trigger condition is again met. However, with **Avg Number** set to On with a value >1, multiple sweeps (data acquisitions) are taken for the measurement. The trigger condition must be met prior to each sweep. The sweep is not stopped when the average count k equals the number N set for Avg Number is reached, but the number k stops incrementing. A measurement average usually applies to all traces, marker results, and numeric results. But sometimes it only applies to the numeric results.

If the analyzer is in Single measurement, pressing the **Continuous** key does not change k and does not cause the sweep to be reset; the only action is to put the analyzer into Continuous measurement operation.

If it's already in continuous sweep:

the INIT:CONT 1 command has no effect

the INIT:CONT 0 command will place the analyzer in Single Sweep but will have no effect on the current sequence until k = N, at which point the current sequence will stop and the instrument will go to

Cont (Continuous Measurement/Sweep)

the idle state.

Frequency/Channel

The key accesses a menu allowing you to set Frequency parameters for the current measurement. All measurements in TD-SCDMA mode have the same menu structure under **FREQ/Channel**.

Key Path **Front-panel key**

Center Freq

Allows you to specify the center frequency of the analyzer.

See also:

RF Center Freq

I/Q Center Freq

Mode	TD-SCDMA
Remote Command	[:SENSe] :FREQuency:CENTer <freq> [:SENSe] :FREQuency:CENTer?
Example	:FREQ:CENT 30 MHZ :FREQ:CENT?
Notes	This command sets either the RF or I/Q Center Frequency depending on the selected input. For RF input it is equivalent to FREQ:RF:CENT For I/Q input it is equivalent to FREQ:IQ:CENT
Preset	Varies with selected input (see RF Center Freq and I/Q Center Freq)
State Saved	Varies with selected input (see RF Center Freq and I/Q Center Freq)
Min	Varies with selected input (see RF Center Freq and I/Q Center Freq)
Max	Varies with selected input (see RF Center Freq and I/Q Center Freq)
Test MIN/MAX/DEF	Yes
Test UP/DOWN	CF Step value
Key Path	FREQ/Channel
Instrument S/W Revision	A.01.60 or later

RF Center Freq

Specifies the RF Center Frequency. This will always access the RF value, even when the selected input is

Frequency/Channel

not RF. The front panel always uses the Freq Center (Selected Input).

Mode	TD-SCDMA
Remote Command	[:SENSE] :FREQUENCY:RF:CENTer <freq> [:SENSE] :FREQUENCY:RF:CENTer?
Example	FREQ:RF:CENt 30 MHz
Notes	This command is the same in all modes, but the parameter is Measurement Global. So the value is independent in each mode and common across all the measurements in the mode.
Preset	1.0 GHz
State Saved	Saved in instrument state.
Min	-79.999995 MHz
Max	Hardware dependent, see Table 17-1 on page 1062
Test MIN/MAX/DEF	Yes
Test UP/DOWN	CF Step value
Instrument S/W Revision	A.01.60 or later

Table 17-1 **Center Frequency**

Option Number	Max Frequency
503	3.699999995 GHz
508	8.499999995 GHz
513	13.799999995 GHz
526	26.999999995 GHz

I/Q Center Freq

Specifies the I/Q Center Frequency. This will always access the I/Q value, even when the selected input is not I/Q. The front panel always uses the Freq Center (Selected Input).

Mode	TD-SCDMA
Remote Command	[:SENSE] :FREQUENCY:IQ:CENTer <freq> [:SENSE] :FREQUENCY:IQ:CENTer?
Example	FREQ:IQ:CENt: 30 MHz
Notes	This command is the same in all modes, but the parameter is Measurement Global. So the value is independent in each mode and common across all the measurements in the mode.
Preset	0 Hz

State Saved	Saved in instrument state.
Min	-39.999995 MHz
Max	39.999995 MHz
Test MIN/MAX/DEF	Yes
Test UP/DOWN	CF Step value
Instrument S/W Revision	A.01.60 or later

CF Step

CF Step changes the step size for the center frequency. Sets and gets the step value for center frequency.

- When the CF Step State is manual, the STEP values for Center Frequency is the same value as that of the CF Step.
- When the CF Step State is auto, the value will be changed to 1.6 MHz automatically.

Mode TD-SCDMA

Remote Command [:SENSe]:FREQuency:CENTer:STEP[:INCRement] <freq>
[:SENSe]:FREQuency:CENTer:STEP[:INCRement]?
[:SENSe]:FREQuency:CENTer:STEP:AUTO ON|OFF|1|0
[:SENSe]:FREQuency:CENTer:STEP:AUTO?

Example
:FREQ:CENT:STEP 100KHZ
:FREQ:CENT:STEP?
:FREQ:CENT:STEP:AUTO OFF
:FREQ:CENT:STEP:AUTO?

Preset 1.6MHz
ON

State Saved Saved in instrument state.

Min 1.0 kHz

Max 1 GHz

Key Path **FREQ/Channel**

Frequency/Channel

Input/Output

The Input/Output features are common across multiple Modes and Measurements. These common features are described in this section. See the Measurement description for information on features that are unique.

The Input/Output key accesses the keys that control the Input/Output parameters of the instrument. In general, these are functions associated with external connections to the analyzer, either to the inputs or the outputs. Since these connections tend to be fairly stable within a given setup, in general the input/output settings do not change when you Preset the analyzer.

Other functions related to the input/output connections, but which tend to change on a measurement by measurement basis, can be found under **Trig** and **Amplitude**. In addition, some of the digital I/O bus configurations can be found under **System**.

NOTE The functions in the Input/Output menu are "global" (common) to all Modes (applications). But individual Input/Output functions only appear in a Mode if they apply to that Mode. Functions that apply to a Mode but not to all measurements in the Mode may be grayed out in some measurements.

The Input Port selection is the first menu under Input/Output:

Remote Command:	[:SENSe] :FEED RF AIQ IQ IONLY QONLY AREFERENCE [:SENSe] :FEED?
Remote Command Notes:	The parameter EXTMixer is for future use and is not supported at this time; sending it generates an error.
Preset:	This setting is unaffected by a Preset or power cycle. It survives Mode Preset and mode changes. It is set to RF on a "Restore Input/Output Defaults" or "Restore System Defaults->All"
State Saved:	Saved in state
Key Path:	Front-panel key
Instrument S/W Revision:	Prior to A.02.00

Input/Output variables - Preset behavior

Virtually all the input/output settings are NOT a part of mode preset. They can be set to their default value by one of the three ways - by using the Restore Input/Output Defaults key on the first page of the input/output menu, by using the System->Restore System Defaults->Input/Output Settings or by using the System -> Restore System Defaults->All. Also, they survive Preset and Power cycle.

A very few of the Input/Output settings do respond to a Mode Preset; for example, if the Calibrator is on it turns off on a Preset, and if DC coupling is in effect it switches to AC on a Preset. These exceptions are

Input/Output

made in the interest of reliability and usability, which overrides the need for absolute consistency. Exceptions are noted in the SCPI table for the excepted functions.

RF Input

Selects the front panel RF input port to be the analyzer signal input. If RF is already selected, pressing this key accesses the RF input setup functions.

Example:	[:SENSe]:FEED RF
Key Path:	Input/Output
Readback:	The current input impedance settings are Readback to this key i.e. "XX, ZZ" where XX is AC or DC and ZZ is 50 or 75
Instrument S/W Revision:	Prior to A.02.00

Input Z Correction

Sets the input impedance for unit conversions. This affects the results when the y axis unit is voltage or current units (dBmV, dB μ V, dB μ A, V, A) but not when it is power units (dBm, W). The impedance you select is for computational purposes only, since the actual impedance is set by internal hardware to 50 ohm. Setting the computational input impedance to 75 ohm is useful when using a 75 ohm to 50 ohm adapter to measure a 75 ohm device on an analyzer with 50 ohm input impedance.

There are a variety ways to make 50 to 75 ohm transitions, such as impedance transformers or minimum loss pads. The choice of the solution that is best for your measurement situation requires balancing the amount of loss that you can tolerate with the amount of measurement frequency range that you need. If you are using one of these pads/adaptors with the **Input Z Corr** function, you might also want to use the **Ext Gain** key. This function is used to set a correction value to compensate for the gain (loss) through your pad. This correction factor is applied to the displayed measurement values.

Remote Command:	[:SENSe]:CORRection:IMPedance[:INPut][:MAGNitude] 50 75 [:SENSe]:CORRection:IMPedance[:INPut][:MAGNitude]?
Example:	CORR:IMP 75 sets the input impedance correction to 75 ohms. CORR:IMP?
Preset:	This is unaffected by Preset but is set to 50 ohms on a "Restore Input/Output Defaults" or "Restore System Defaults->All" Some instruments/options may have 75 ohms available.
State Saved:	Saved in State
Key Path:	Input/Output, RF Input
Readback:	50 or 75. Current setting reads back to the RF key.
Instrument S/W Revision:	Prior to A.02.00

RF Coupling

Specifies alternating current (AC) or direct current (DC) coupling at the analyzer RF input port. Selecting AC coupling switches in a blocking capacitor that blocks any DC voltage present at the analyzer input. This decreases the input frequency range of the analyzer, but prevents damage to the input circuitry of the analyzer if there is a DC voltage present at the RF input.

In AC coupling mode, you can view signals less than 10 MHz but the amplitude accuracy is not specified. To accurately see a signal of less than 10 MHz, you must switch to DC coupling.

Some amplitude specifications apply only when coupling is set to DC. Refer to the appropriate amplitude specifications and characteristics for your analyzer.

When operating in DC coupled mode, ensure protection of the analyzer input circuitry by limiting the DC part of the input level to within 200 mV of 0 Vdc. In AC or DC coupling, limit the input RF power to +30 dBm (1 Watt).

Selecting Input Coupling

X-Series Option	AC Frequency Range	N9010A DC Frequency Range	N9020A DC Frequency Range
Option 503	10 MHz to 3.6 GHz	9 kHz to 3.6 GHz	3 Hz to 3.6 GHz
Option 507	10 MHz to 7.0 GHz	9 kHz to 7.0 GHz	
Option 508	10 MHz to 8.4 GHz		3 Hz to 8.4 GHz
Option 513	10 MHz to 13.6 GHz	9 kHz to 13.6 GHz	3 Hz to 13.6 GHz
Option 526	10 MHz to 26.5 GHz	9 kHz to 26.5 GHz	3 Hz to 26.5 GHz

Remote Command: :INPut:COUPling AC|DC
 :INPut:COUPling?

Example: INP:COUP DC

Preset: AC

State Saved: Saved in State

Key Path: **Input/Output, RF Input**

Instrument S/W Revision: Prior to A.02.00

I/Q

This feature is not available unless the Baseband I/Q option (BBA) is installed.

Selects the front panel I/Q input ports to be the analyzer signal input. If I/Q is already selected, pressing this key accesses the I/Q setup menu.

Restriction and Notes Not all measurements support the use of the I/Q signal input. When I/Q is selected in a measurement that does not support it, the "Meas invalid with I/Q inputs" error condition occurs.

Input/Output

Remote Command Notes	<p>The parameters IQ IONLy QONLy are only supported for backwards compatibility. The E44406 SCPI has the following that corresponds to FEED:IQ:TYPE for MXA.</p> <p>[[:SENSe]:FEED IQ IONLy QONLy</p> <p>[[:SENSe]:FEED?</p> <p>[[:SENSe]:FEED IQ will set the I/Q path to IQ</p> <p>[[:SENSe]:FEED IONLy will set the I/Q path to I Only</p> <p>[[:SENSe]:FEED QONLy will set the I/Q path to QOnly</p> <p>Note [[:SENSe]:FEED? will not be backward compatible.</p> <p>The query [[:SENSe]:FEED? will always returns AIQ whatever the type of legacy parameters IQ IONLy QONLy has been used.</p>
Example	FEED AIQ
Key Path	Input/Output
Mode	BASIC, CDMA2K, EDGE GSM, TDSCDMA, VSA89601, WIMAX OFDMA
Instrument S/W Revision	Prior to A.02.00

The Baseband I/Q functionality is a hardware option. It is option BBA. If the option is not installed, none of the I/Q functionality is enabled.

The Baseband I/Q has four input ports and one output port. The input ports are I, I-bar, Q, and Q-bar. The I and I-bar together compose the I channel and the Q and Q-bar together compose the Q channel. Each channel has two modes of operation, Single-Ended (also called "unbalanced") and Differential Input (also called "balanced"). When in Single-Ended operation, only the main port (I or Q) is used and the complementary port (I-bar or Q-bar) is ignored. When in Differential Input mode, both main and complementary ports are used.

The input settings (range, attenuation, skew, impedance, external gain) apply to the channels, not the individual ports.

The system supports a variety of 1 M Ω input passive probes as well as the Agilent 113x Series active differential probes using the Infinimax probe interface.

The Agilent 113x Series active probes can be used for both single ended and differential measurements. In either case a single connection is made for each channel (on either the I or Q input). The input is automatically configured to 50 Ω single ended and the probe power is supplied through the Infinimax interface. The probe can be configured for a variety of input coupling and low frequency rejection modes. In addition, a wide range of offset voltages and probe attenuation accessories are supported at the probe interface. The active probe has the advantage that it does not significantly load the circuit under test, even with unity gain probing.

With passive 1 M Ω probes, the probe will introduce a capacitive load on the circuit, unless higher attenuation is used at the probe interface. Higher attenuation reduces the signal level and degrades the signal-to-noise-ratio of the measurement. Passive probes are available with a variety of attenuation values for a moderate cost. Most Agilent passive probes can be automatically identified by the system, setting the input impedance setting required as well as the nominal attenuation. For single ended

measurements a single probe is used for each channel. Other passive probes can be used, with the attenuation and impedance settings configured manually.

For full differential measurements, the system supports probes on each of the four inputs. The attenuation of the probes should be the same for good common mode rejection and channel match.

Both active and passive probes in single ended and differential configurations can be calibrated. This calibration uses the Cal Out BNC connection and a probe connection accessory. The calibration achieves excellent absolute gain flatness in a probed measurement. It matches both the gain and frequency response of the I and Q channels as well as any delay skew, resulting in high accuracy in derived measurements such as Error Vector Magnitude (EVM).

When a probe is connected a status message will be displayed. The message will indicate if calibration data is available or not. Calibration data is saved for each type of probe (including "none") for each port and will be reapplied whenever that type of probe is re-connected to the same port. For probes with EEPROM identification, the calibration data will be stored based on the unique probe identifier and will reapply data for that particular probe if it is available. The data will not follow a probe from one port to another. For probes without EEPROM identification, the instrument cannot distinguish between different probes of the same type and it will use the data from the last calibration for that probe type on that port.

When in differential mode, both the main and complementary probes are expected to be of the same type.

In some situations, the I and Q channels should be configured identically. In other situations it is convenient to control them independently. Some menus have a "Q Same as I" setting that will cause the Q channel configuration to mirror the I channel configuration, avoiding the overhead of double data entry when the channels should be the same.

The output port is for calibrating the I/Q input ports, although it can also be manually controlled.

There are two types of calibrations available: cable calibration and probe calibration. The cable calibration will guide you through connecting each input port in turn. All ports must be calibrated together. The probe calibration is done for a specific channel (I or Q). If in Single-Ended mode, only the main port is calibrated. When in Differential Input mode, you are guided through calibrating both main and complementary ports.

The front panel I/Q port LEDs indicate the current state of that port. On (green) indicates it is active, and off (dark) indicates it is not in use. For example, the Cal Out port LED is on if and only if there is signal coming out of that port.

The input is a context and some parameters have separate values for each context. The SCPI for these parameters has an optional "[:RF|IQ]" node. If the specific context is omitted, the command acts on the current input context's value. Here are the parameters that are input context sensitive:

- Center Frequency
- Trigger Source

It is important to distinguish between the I and Q input ports and the displayed I and Q data values. The I and Q input ports feed into a digital receiver that does digital tuning and filtering. The I and Q data seen by you (either on the display or through SCPI) corresponds to the real ("I") and the imaginary ("Q") output from the digital receiver. When the input path is $I+jQ$ or I Only and the center frequency is 0 Hz the I input ends up in as the real output from the receiver and appears as "I" data. Likewise, when the input path is $I-jQ$ and the center frequency is 0 Hz, the Q input ends up as the imaginary output from the

Input/Output

receiver and appears as "Q" data. However, when the input path is Q Only, the Q input is sent to the receiver as $Q+j0$, so the receiver output has the Q input coming out on the real output, and so in Q Only, the signal from the Q input port appears as the "I" data. Another situation where the I and Q data do not necessarily correspond directly to the I and Q inputs is when the center frequency is non-zero. The digital processing involved in the tuning is a complex operation. This will result in I Only data appearing as both "I" and "Q" data, the same as that signal would appear if seen through the RF input port.

I/Q Path

Select which I/Q input channels are active. The LED next to each I/Q input port will be on when that port is active.

The analysis bandwidth for each channel is the same as that of the instrument. So, for example, the base N9020A has a bandwidth of 10 MHz. With I/Q input the I and Q channels would each have an analysis bandwidth of 10 MHz, giving 20 MHz of bandwidth when the I/Q Path is I+jQ. With option B25, the available bandwidth becomes 25 MHz, giving 25 MHz each to I and Q and 50 MHz to I+jQ. With option S40, the available bandwidth becomes 40 MHz, giving 40 MHz each to I and Q, that is 80 MHz to I+jQ.

I/Q voltage to power conversion processing is dependent on the I/Q Path selected.

- With I+jQ input we know that the input signal may not be symmetrical about 0 Hz, because it has a complex component. Therefore, above 0 Hz only the positive frequency information is displayed, and below 0 Hz only the negative frequency information is displayed.
- With all other Input Path selections, the input signal has no complex component and therefore is always symmetrical about 0 Hz. In this case, by convention, the power conversion shows the combined voltage for both the positive and negative frequencies. The information displayed below 0 Hz is the mirror of the information displayed above 0 Hz. This results in a power reading 6.02 dB higher (for both) than would be seen with only the positive frequency voltage. Note also that, in this case the real signal may have complex modulation embedded in it, but that must be recovered by further signal processing.

Remote Command	<code>[:SENSe] :FEED:IQ:TYPE IQ IONLY QONLY</code> <code>[:SENSe] :FEED:IQ:TYPE?</code>
Example	Set the input to be both the I and Q channels, combined as $I + j * Q$. <code>FEED:IQ:TYPE IQ</code>
Key Path	Input/Output, I/Q
Preset	IQ
State Saved	Yes
	This is unaffected by Preset but is set to the default value on a "Restore Input/Output Defaults" or "Restore System Defaults->All"
Range	I+jQ I Only Q Only
Readback Text	I+jQ I Only Q Only
Instrument S/W Revision	Prior to A.02.00

Remote Command: :INPut[1]:IQ:TYPE IQ|I|Q
 :INPut[1]:IQ:TYPE?
 Preset: IQ
 Instrument S/W Revision: Prior to A.02.00

I+jQ Set the signal input to be both the I and Q channels. The I and Q channel data will be combined as $I + j * Q$.

Example Set the input to be both the I and Q channels, combined as $I + j * Q$.
 FEED:IQ:TYPE IQ
 Key Path **Input/Output, I/Q, I/Q Path**
 Instrument S/W Revision Prior to A.02.00

I Only Set the signal input to be only the I channel. The Q channel will be ignored. The data collected is still complex. When the center frequency is 0 the imaginary part will always be zero, but for any other center frequency both the real and imaginary parts will be significant.

Example Set the input to be only the I channel.
 FEED:IQ:TYPE IONL
 Key Path **Input/Output, I/Q, I/Q Path**
 Instrument S/W Revision Prior to A.02.00

Q Only Set the signal input to be only the Q channel. The I channel will be ignored. The Q channel will be sent to the digital receiver block as $Q+j0$. The receiver's output is still complex. When the center frequency is 0 the imaginary part will always be zero, but for any other center frequency both the real and imaginary parts will be significant. Note that since the receiver's real output is displayed as the "I" data, when the center frequency is 0, the Q Only input appears as the "I" data.

Example Set the input to be only the Q channel.
 FEED:IQ:TYPE QONL
 Key Path **Input/Output, I/Q, I/Q Path**
 Instrument S/W Revision Prior to A.02.00

I Setup

Access the channel setup parameters for the I channel.

Key Path **Input/Output, I/Q**
 Instrument S/W Revision Prior to A.02.00

I Differential Input Select differential input on or off for the I channel. For differential input (also

Input/Output

called balanced input), the analyzer uses both main and complementary ports. When differential input is off (also called single-ended or unbalanced input), the analyzer uses only the main port.

Remote Command	<code>:INPut:IQ[:I]:DIFFerential OFF ON 0 1</code> <code>:INPut:IQ[:I]:DIFFerential?</code>
Dependencies/Couplings	Some active probes include built-in differential capability. When one of these probes is sensed, this key is disabled. Since the differential capability is handled in the probe, the Analyzer will use only the main port and the key will show that the Analyzer's Differential Input mode is Off (indicating that the complementary port not in use). When Q Same as I is On, the value set for I will also be copied to Q.
Restriction and Notes	When Differential Input = On, the analyzer will check for attenuation mismatches between the I and I-bar ports. If the difference in attenuation values exceeds 0.5 dB an error condition will be set.
Example	Put the I channel in Differential Input mode <code>INP:IQ:DIFF ON</code>
Key Path	Input/Output, I/Q, I Setup
Preset	Off
State Saved	Yes This is unaffected by Preset but is set to the default value on a "Restore Input/Output Defaults" or "Restore System Defaults->All"
Range	Off On
Instrument S/W Revision	Prior to A.02.00
Remote Command:	<code>:INPut[1]:IQ:BALanced[:STATe] OFF ON 0 1</code> <code>:INPut[1]:IQ:BALanced[:STATe]?</code>
Preset:	OFF
Remote Command Notes:	This backwards compatibility SCPI command was for an instrument without independent settings for the I and Q channels. Therefore, it is tied only to the I channel and does not provide an equivalent for the Q channel. For proper operation of the backwards compatibility command Q Same as I should be set to On.
Instrument S/W Revision:	Prior to A.02.00

I Input Z Select the input impedance for the I channel. The impedance applies to both the I and I-bar ports.

The input impedance controls the hardware signal path impedance match. It is not used for converting voltage to power. The voltage to power conversion always uses the Reference Z parameter. The

Reference Z parameter applies to both I and Q channels.

Remote Command	:INPut [1]:IQ[:I]:IMPedance LOW HIGH :INPut [1]:IQ[:I]:IMPedance?
Dependencies/Couplings	Input impedance is a built-in characteristic of a probe. Therefore, whenever a probe is sensed, this key is disabled and the value is set to match the probe. When no probe is sensed on Q and Q Same as I is On, the value set for I will also be copied to Q.
Remote Command Notes	LOW = 50 Ω , HIGH = 1 M Ω
Example	Set the I channel input impedance to 1 M Ω INP:IQ:IMP HIGH
Key Path	Input/Output, I/Q, I Setup
Preset	LOW
State Saved	Yes This is unaffected by Preset but is set to the default value on a "Restore Input/Output Defaults" or "Restore System Defaults->All"
Range	50 Ω 1 M Ω
Instrument S/W Revision	Prior to A.02.00

I Skew This command sets the skew factor for the I channel. The skew will shift the channel's data in time. Use this to compensate for differences in the electrical lengths of the input paths due to cabling.

Remote Command	[:SENSE]:CORRection:IQ[:I]:SKEW <seconds> [:SENSE]:CORRection:IQ[:I]:SKEW?
Example	Delay the data for the I channel by 10 ns. CORR:IQ:SKEW 10 ns
Key Path	Input/Output, I/Q, I Setup
Preset	0
State Saved	Yes This is unaffected by Preset but is set to the default value on a "Restore Input/Output Defaults" or "Restore System Defaults->All"
Range	0 s to 100 ns
Instrument S/W Revision	Prior to A.02.00

I Probe Access the probe setup parameters for the I channel. See [“I/Q Probe Setup” on page 1077](#).

Key Path	Input/Output, I/Q, I Setup
----------	-----------------------------------

Input/Output

State Saved	No
Readback Text	[<I port probe id> This is reporting the type of probe sensed on the I port. There is no parameter for overriding what is sensed.
Instrument S/W Revision	Prior to A.02.00

Combined Differential/Input Z This is SCPI only (no front panel) and is for backwards compatibility only. It combines the Differential Input and Input Z selections into a single SCPI command.

Remote Command: :INPut:IMPedance:IQ U50|B50|U1M|B1M
:INPut:IMPedance:IQ?

Preset: U50

Remote Command Notes: The enum values translate as follows:
U50: Differential Input = Off, Input Z = 50 Ω
B50: Differential Input = On, Input Z = 50 Ω
U1M: Differential Input = Off, Input Z = 1 M Ω
B1M: Differential Input = On, Input Z = 1 M Ω

This command is for backwards compatibility. It combines the Input Z (50 Ω or 1 M Ω) parameter with the Differential Input (Off = "Unbalanced", On = "Balanced") parameter into a single enumeration.

This backwards compatibility SCPI command was for an instrument without independent settings for the I and Q channels. Therefore, it is tied only to the I channel and does not provide an equivalent for the Q channel. For proper operation of the backwards compatibility command Q Same as I should be set to On.

Also, note the subtle difference between this SCPI command and the backwards compatibility command for Input Z. The Input Z SCPI has "IQ" before "IMP" while this command has that order reversed.

Dependencies/Couplings: This command does not have an independent parameter, but instead is tied to the Differential Input and Input Z parameters. The coupling for those parameters apply to this command too.

Example: :INPut:IMPedance:IQ U50
This is equivalent to the following two SCPI commands:
:INP:IQ:DIFF OFF
:INP:IQ:IMP 50

Instrument S/W Revision: Prior to A.02.00

Q Setup

Access the channel setup parameters for the Q channel.

Key Path	Input/Output, I/Q
Readback Text	When Q Same as I is On the readback is "Q Same as I".
Instrument S/W Revision	Prior to A.02.00

Q Same as I Many, but not all, usages require the I and Q channels have an identical setup. To simplify channel setup, the Q Same as I will cause the Q channel parameters to be mirrored from the I channel. That way you only need to set up one channel (the I channel). The I channel values are copied to the Q channel, so at the time Q Same as I is turned off the I and Q channel setups will be identical. This does not apply to Probe settings or to parameters that determined by the probe.

Remote Command	:INPut:IQ:MIRROred OFF ON 0 1 :INPut:IQ:MIRROred?
Dependencies/Couplings	Only displayed for the Q channel. When Yes, the I channel values for some parameters are mirrored (copied) to the Q channel. However, when a parameter is determined by the type of probe and a probe is sensed, the probe setting is always used and the I channel setting is ignored. The following parameters are mirrored: Differential Input (when not determined by probe) Input Z (when not determined by probe)
Example	Turn off the mirroring of parameters from I to Q. INP:IQ:MIRR OFF
Key Path	Input/Output, I/Q, Q Setup
Preset	This is unaffected by Preset but is set to the default value (Q Same as I set to "On") on a "Restore Input/Output Defaults" or "Restore System Defaults->All"
State Saved	Saved in instrument state.
Range	On Off
Readback Text	"Q Same as I" when On, otherwise none.
Instrument S/W Revision	Prior to A.02.00

Q Differential Input Select differential input on or off for the Q channel. For differential input (also called balanced input), the analyzer uses both the Q and Q-bar ports. When differential input is off (also called single-ended or unbalanced input), the analyzer uses only the Q port.

Remote Command	:INPut:IQ:Q:DIFFerential OFF ON 0 1 :INPut:IQ:Q:DIFFerential?
-----------------------	--

Input/Output

Dependencies/Couplings	<p>Some active probes include built-in differential capability. When one of these probes is sensed, this key is disabled. Since the differential capability is handled in the probe, the Analyzer will use only the main port and the key will show that the Analyzer's Differential Input mode is Off (indicating that the complementary port not in use).</p> <p>When a differential probe is not sensed and Q Same as I is On, the value set for I will be copied to Q. This key is disabled when Q Same as I is On.</p>
Restriction and Notes	<p>When Differential Input = On, the analyzer will check for attenuation mismatches between the Q and Q-bar ports. If the difference in attenuation values exceeds 0.5 dB an error condition will be set.</p>
Example	<p>Put the Q channel in Differential Input mode</p> <p>INP:IQ:Q:DIFF ON</p>
Key Path	Input/Output, I/Q, Q Setup
Preset	Off
State Saved	On
	<p>This is unaffected by Preset but is set to the default value on a "Restore Input/Output Defaults" or "Restore System Defaults->All"</p>
Range	Off On
Instrument S/W Revision	Prior to A.02.00

Q Input Z Select the input impedance for the Q channel. The impedance applies to both the Q and Q-bar ports.

The input impedance controls the hardware signal path impedance match. It is not used for converting voltage to power. The voltage to power conversion always uses the Reference Z parameter. The Reference Z parameter applies to both I and Q channels.

Remote Command	<pre>:INPut [1] : IQ : Q : IMPedance LOW HIGH :INPut [1] : IQ : Q : IMPedance?</pre>
Dependencies/Couplings	<p>Input impedance is a built-in characteristic of a probe. Therefore, whenever a probe is sensed, this key is disabled and the value is set to match the probe.</p> <p>When no probe is sensed and Q Same as I is On, the value set for I will also be copied to Q. This key is disabled when Q Same as I is On.</p>
Remote Command Notes	LOW = 50 Ω , HIGH = 1 M Ω
Example	<p>Set the Q channel input impedance to 1 MΩ</p> <p>INP:IQ:Q:IMP HIGH</p>
Key Path	Input/Output, I/Q, Q Setup
Preset	LOW

State Saved	On
	This is unaffected by Preset but is set to the default value on a "Restore Input/Output Defaults" or "Restore System Defaults->All"
Range	50 Ω 1 M Ω
Instrument S/W Revision	Prior to A.02.00

Q Skew This command sets the skew factor for the Q channel. The skew will shift the channel's data in time. Use this to compensate for differences in the electrical lengths of the input paths due to cabling and probes.

Remote Command	[:SENSE]:CORREction:IQ:Q:SKEW <seconds> [:SENSE]:CORREction:IQ:Q:SKEW?
Example	Delay the data for the Q channel by 10 ns. CORR:IQ:Q:SKEW 10 ns
Key Path	Input/Output, I/Q, Q Setup
Preset	0
State Saved	Yes
	This is unaffected by Preset but is set to the default value on a "Restore Input/Output Defaults" or "Restore System Defaults->All"
Range	0 s to 100 ns
Instrument S/W Revision	Prior to A.02.00

Q Probe Access the probe setup parameters for the Q channel. See [“I/Q Probe Setup” on page 1077](#).

Key Path	Input/Output, I/Q, Q Setup
State Saved	No
Readback Text	[<Q port probe id>] This is reporting the type of probe sensed on the Q port. There is no parameter for overriding what is sensed.
Instrument S/W Revision	Prior to A.02.00

I/Q Probe Setup

The set of I/Q probe setup parameters will change based on the type of probe that is sensed. All probe types have the Attenuation parameter, and all probe types can be calibrated. The remaining parameters are only available for some probe types and will not be shown when not available. The probe type is determined by and reported for only for the I and Q ports, never the I-bar or Q-bar ports. The menu title will be "<ch>: <probe id>", where "<ch>" is either "I" or "Q" and "<probe id>" is the type of probe. For example, for the I Probe setup with an Agilent 1130A probe connected to the I port, the title will be "I: 1130A".

Input/Output

Probe calibration data is stored for each probe type for each channel. When no probe is sensed, the probe type "Unknown" is used, and this is also treated like a probe type with its own calibration data. When a probe is changed, the calibration data for that probe type for that port is restored. An advisory message will be displayed showing the new probe type and the calibration status. The calibration data is stored permanently (survives power cycle) and is not affected by Preset or any of the Restore commands. When the probe has EEPROM identification (most newer Agilent probes have this), the calibration data is stored by probe serial number and port, so if you have two probes of the same type, the correct calibration data will be used for each. For probes that do not have EEPROM identification, the calibration data is stored by probe type and port and the instrument cannot distinguish between different probes of the same type. In all cases (with or without EEPROM identification), the calibration data is port specific, so it will not follow a specific probe from port to port if the probe is moved.

The "Unknown" probe type is used whenever no probe is sensed. When no calibration data exists for "Unknown" the latest cable calibration data is used (see [“I/Q Guided Calibration” on page 1109](#)).

Attenuation The attenuation is part of the calibration data stored with the probe type and is initially the value that was returned by the last calibration. You are able to modify this value and any changes will be stored with the calibration data and will survive power cycles and presets. When a probe calibration is performed the attenuation value will be overwritten by the calibration.

Remote Command	<code>[:SENSe]:CORRection:IQ:I Q:ATTenuation:RATio <real></code> <code>[:SENSe]:CORRection:IQ:I Q:ATTenuation:RATio?</code>
Restriction and Notes	Each probe type has its own attenuation setting. As probes are changed the attenuation value will reflect the new probe's setting. Changing the attenuation affects only the current probe type's setting and leaves all others unchanged.
Example	Set the attenuation for the current I probe to 100.00:1. <code>CORR:IQ:I:ATT:RAT 100</code>
Key Path	Input/Output, I/Q, I Setup Q Setup, I Probe Q Probe
Preset	Each probe type has its own default. The default for the "Unknown" probe type is 1:1.
State Saved	Saved with probe calibration data. It survives power cycle and is not affected by Preset or Restore.
Range	0.001 to 10000
Instrument S/W Revision	Prior to A.02.00

This is an alternate form of the SCPI that allows input as a power instead of a ratio.

Remote Command:	<code>[:SENSe]:CORRection:IQ:I Q:ATTenuation <rel_amp></code> <code>[:SENSe]:CORRection:IQ:I Q:ATTenuation?</code>
Range:	-60 dB to +80 dB
Example:	Set the attenuation for the current I probe type to 100.00:1. <code>CORR:IQ:I:ATT 20 dB</code>

Instrument S/W Revision: Prior to A.02.00

Offset Some active probes have DC offset capability. When one of these probes is connected this control will be visible. The signal is will be adjusted for the DC offset before entering the analyzer's port. This allows for removal of a DC offset before hitting the analyzer's input port voltage limits. For example, a signal that varies 1 V peak-to-peak with a DC offset equal to the analyzer's max input voltage would exceed the input limits of the analyzer for half its cycle. Removing the DC offset allows the analyzer to correctly process the entire signal.

Remote Command	: INPut:OFFSet:I Q <voltage> : INPut:OFFSet:I Q?
Restriction and Notes	Only some probe types support Offset. For those that do, each probe type has its own Offset setting. As probes are changed the Offset value will reflect the new probe's setting. Changing the Offset affects only the current probe type's setting and leaves all others unchanged.
Example	Remove a DC offset of -0.5 V from the I channel input. INP:OFFS:I -0.5
Key Path	Input/Output, I/Q, I Setup Q Setup, I Probe Q Probe
Preset	0 V
State Saved	Saved with probe calibration data. It survives power cycle and is not affected by Preset or Restore.
Range	-18 V to +18 V
Instrument S/W Revision	Prior to A.02.00

Coupling Some probe types allow coupling to reject low frequencies. This will filter out the DC component of a signal that is composed of a DC bias plus some AC signal. This control is visible only for probe types that have this capability.

Remote Command	: INPut:COUPling:I Q DC LFR1 LFR2 : INPut:COUPling:I Q?
Restriction and Notes	Only some probe types support Coupling. For those that do, each probe type has its own Coupling setting. As probes are changed the Coupling value will reflect the new probe's setting. Changing the Coupling affects only the current probe type's setting and leaves all others unchanged.
Example	Set the probe to low frequency rejection below 1.7 Hz. INP:COUP:I LFR1
Key Path	Input/Output, I/Q, I Setup Q Setup, I Probe Q Probe
Preset	DC
State Saved	Saved with probe calibration data. It survives power cycle and is not affected by Preset or Restore.

Input/Output

Range	DC AC 1.7 Hz LFR1 AC 0.14 Hz LFR2
Readback Text	DC LFR1 LFR2
Instrument S/W Revision	Prior to A.02.00

DC Turn off low frequency rejection, allowing signals down to DC.

Example	Turn off low frequency rejection on the I channel INP:COUP:I DC
Key Path	Input/Output, I/Q, I Setup Q Setup, I Probe Q Probe, Coupling
Instrument S/W Revision	Prior to A.02.00

LFR1 Turn on low frequency rejection, rejecting signal component lower than 1.7 Hz.

Example	Turn on low frequency rejection on the I channel for frequencies lower than 1.7 Hz INP:COUP:I LFR1
Key Path	Input/Output, I/Q, I Setup Q Setup, I Probe Q Probe, Coupling
Instrument S/W Revision	Prior to A.02.00

LFR2 Turn on low frequency rejection, rejecting signal component lower than 0.14 Hz.

Example	Turn on low frequency rejection on the I channel for frequencies lower than 0.14 Hz INP:COUP:I LFR2
Key Path	Input/Output, I/Q, I Setup Q Setup, I Probe Q Probe, Coupling
Instrument S/W Revision	Prior to A.02.00

Calibrate Invoke the guided probe calibration. The guided probe calibration is context sensitive and depends on the channel (I or Q) and the Differential Input state. The calibration is only performed on the selected channel. When Differential Input is on, both the probe attached to the main port and the probe attached to the complementary port are calibrated. When Differential Input is off, only the probe attached to the main port is calibrated. See [“I/Q Guided Calibration” on page 1109](#).

Key Path	Input/Output, I/Q, I Setup Q Setup, I Probe Q Probe, Coupling
----------	--

Readback Text	The last calibration date, or if no calibration exists, "(empty)". Last: <cal date> <cal time> Example: Last: 8/22/2007 1:02:49 PM
Instrument S/W Revision	Prior to A.02.00

Clear Calibration Clear the calibration data for the current port and probe. It does not clear the data for other probe types or other ports. If the sensed probe has EEPROM identification, only the data for that specific probe is cleared. After this command has completed, the probe calibration state will be the same as if no probe calibration had ever been performed for the specified channel and probe; the probe attenuation will be the default value for that probe type and the Cable Calibration frequency response corrections will be used. This command is dependent on the Differential Input state. When Differential Input is on, both the data for the probe attached to the main port and the data for the probe attached to the complementary port are cleared. When Differential Input is off, only data for the probe attached to the main port is cleared.

Remote Command	:CALibration:IQ:PROBe:I Q:CLEAr
Example	Clear the calibration data for the I channel and the current probe (with EEPROM identification) or probe type (without EEPROM identification). :CAL:IQ:PROBe:I:CLE
Key Path	Input/Output, I/Q, I Setup Q Setup, I Probe Q Probe
Instrument S/W Revision	Prior to A.02.00

Reference Z

Set the value of the impedance to be used in converting voltage to power for the I and Q channels. This does not change the hardware's path impedance (see "I Input Z" on page 1072).

Remote Command	:INPut:IMPedance:REFErence <integer> :INPut:IMPedance:REFErence?
Example	Set the I/Q reference impedance to 50 Ω INP:IMP:REF 50
Key Path	Input/Output, I/Q
Preset	50 Ω
State Saved	Yes This is unaffected by Preset but is set to the default value on a "Restore Input/Output Defaults" or "Restore System Defaults->All"
Range	1 Ω to 1 M Ω

Input/Output

Instrument S/W Revision Prior to A.02.00

RF Calibrator

Lets you choose a calibrator signal to look at or turns the calibrator "off" (meaning switches back to the selected input). When one of the calibrator signals is selected, the analyzer routes that signal (an internal amplitude reference) to the analyzer, while leaving the main input selection menu (RF or I/Q) unchanged.

This function presets to OFF on a Mode Preset, which causes the internal circuitry to switch back to the selected input (RF, Ext Mix or I/Q).

Remote Command: [:SENSe]:FEED:AREFERENCE REF50|REF4800|COMB|OFF
[:SENSe]:FEED:AREFERENCE?

Example: FEED:AREF REF50 selects the 50 MHz amplitude reference as the signal input.
FEED:AREF REF4800 selects the 4.8 GHz amplitude reference as the signal input
FEED:AREF COMB selects the 300 MHz comb modulated signal as the signal input
FEED:AREF OFF turns the calibrator "off" (meaning switches back to the selected input – RF, ExtMix or I/Q)

Dependencies/Couplings: Selecting an input (RF, Ext Mix or I/Q) turns the Calibrator OFF. This is true whether the input is selected by the keys or with the [:SENSe]:FEED command.

The 4.8 GHz internal reference is only available in some models, and only with options 507, 508, 513, and 526.

Preset: OFF

State Saved: Saved in State

Key Path: **Input/Output**

Readback: Off, 50 MHz, 4.8 GHz or Comb

Instrument S/W Revision: Prior to A.02.00

50 MHz

Key Path **Input/Output, RF Calibrator**

Readback 50 MHz

Instrument S/W Revision Prior to A.02.00

4.8 GHz

Selects the 4.8 GHz internal reference as the input signal.

Dependencies/Couplings:	This key is blank (unavailable) in MXA with frequency option 503, and in EXA
Key Path:	Input/Output, RF Calibrator
Readback:	4.8 GHz
Instrument S/W Revision:	Prior to A.02.00

Comb

Key Path	Input/Output, RF Calibrator
Readback	Comb
Instrument S/W Revision	Prior to A.02.00

Off

Switches the input back to the selected input (RF, Ext Mix or I/Q)

Key Path	Input/Output, RF Calibrator
Readback	Off
Instrument S/W Revision	Prior to A.02.00

External Gain

Compensates for gain/loss in the measurement system outside the spectrum analyzer. The External Gain is subtracted from the amplitude readout (or the loss is added to the amplitude readout). So, the displayed signal level represents the signal level at the output of the device-under-test, which can be the input of an external device that provides gain/loss.

Entering an External Gain value does not affect the Reference Level, therefore the trace position on screen changes, as do all of values represented by the trace data. Thus, the values of exported trace data, queried trace data, marker amplitudes, trace data used in calculations such as N dB points, trace math, peak threshold, etc., are all affected by External Gain. Changing the External Gain, even on a trace which is not updating, will immediately change all of the above, without new data needing to be taken.

NOTE	Changing the External Gain causes the analyzer to immediately stop the current sweep and prepare to begin a new sweep, but the data will not change until the trace data updates, because the offset is applied to the data as it is taken. If a trace is exported with a nonzero External Gain, the exported data will contain the trace data with the offset applied.
-------------	---

Input/Output

In the Spectrum Analyzer mode, a Preamp is the common external device providing gain/loss. In a measurement application mode like GSM or W-CDMA, the gain/loss could be from a BTS (Base Transceiver Station) or an MS (Mobile Station). So in the Spectrum Analyzer mode MS and BTS would be grayed out and the only choice would be Ext Preamp. Similarly in some of the digital communications applications, Ext Preamp will be grayed out and you would have a choice of MS or BTS.

Dependencies/Couplings: The Ext Preamp, MS, and BS keys may be grayed out depending on which measurement is currently selected. If any of the grayed out keys are pressed, or the equivalent SCPI command is sent, an advisory message is generated.

Key Path: **Input/Output**

Readback: 1-of-N selection | [variable]

Instrument S/W Revision: Prior to A.02.00

Ext Preamp

This function is similar to the reference level offset function. Both affect the displayed signal level. Ref Lvl Offset is a mathematical offset only, no analyzer configuration is affected. Ext Preamp gain is used when determining the auto-coupled value of the Attenuator. The External Gain value and the Maximum Mixer Level settings are both part of the automatic setting equation for the RF attenuation setting. (10 dB of Attenuation is added for every 10 dB of External Gain.)

Please note that the Ref Lvl Offset and Maximum Mixer Level are described in the Amplitude section. They are reset by the instrument Preset. The External Preamp Gain is reset by the "Restore Input/Output Defaults" or "Restore System Defaults->All functions. The External Gain is subtracted from the amplitude readout so that the displayed signal level represents the signal level at the output of the device-under-test, which is the input of the external device that is providing gain/loss.

Remote Command: [:SENSe]:CORRection:SA[:RF]:GAIN <rel_amp>

[:SENSe]:CORRection:SA[:RF]:GAIN?

Example: CORR:SA:GAIN 10 sets the Ext Gain value to 10 dB

CORR:SA:GAIN -10 sets the Ext Gain value to -10 dB (that is, an attenuation of 10 dB)

Dependencies/Couplings: The reference level limits are determined in part by the External Gain/Atten, Max Mixer Level, and RF Atten.

This key is grayed out in many application Modes.

Preset: This is unaffected by Preset but is set to 0 dB on a "Restore Input/Output Defaults" or "Restore System Defaults->All"

State Saved: Saved in State

Min: -81.90 dB

Max:	81.90 dB
Key Path:	Input/Output, External Gain
Readback:	Preamp Gain, <Ext Gain value> dB
Instrument S/W Revision:	Prior to A.02.00

MS

Sets an external gain/attenuation value for MS (Mobile Station) tests.

Remote Command:	[:SENSe]:CORRection:MS[:RF]:GAIN <rel_amp1> [:SENSe]:CORRection:MS[:RF]:GAIN?
Example:	CORR:MS:GAIN 10 sets the Ext Gain value to 10 dB CORR:MS:GAIN -10 sets the Ext Gain value to -10 dB (that is, a loss of 10 dB.)
Dependencies/Couplings:	The reference level limits are determined in part by the External Gain, Max Mixer Level, RF Atten This key is grayed out in the SA Mode.
Preset:	This is unaffected by Preset but is set to 0 dB on a "Restore Input/Output Defaults" or "Restore System Defaults->All"
State Saved:	Saved in State
Min:	-100 dB
Max:	100 dB
Key Path:	Input/Output, External Gain
Readback:	MS, <Ext Gain value> dB
Instrument S/W Revision:	Prior to A.02.00

BTS

Sets an external attenuation value for BTS (Base Transceiver Station) tests.

Remote Command:	[:SENSe]:CORRection:BTS[:RF]:GAIN <rel_amp1> [:SENSe]:CORRection:BTS[:RF]:GAIN?
Example:	CORR:BTS:GAIN 10 sets the Ext Gain value to 10 dB CORR:BTS:GAIN -10 sets the Ext Gain value to -10 dB (that is, a loss of 10 dB.)
Dependencies/Couplings:	The reference level limits are determined in part by the External Gain, Max Mixer Level, RF Atten This key is grayed out in the SA Mode.

Input/Output

Preset:	This is unaffected by Preset but is set to 0 dB on a "Restore Input/Output Defaults" or "Restore System Defaults->All"
State Saved:	Saved in State
Min:	-100 dB
Max:	100 dB
Key Path:	Input/Output, External Gain
Readback:	BTS, <Ext Gain value> dB
Instrument S/W Revision:	Prior to A.02.00

I Ext Gain

This function affects only the I channel input, except when the Input Path is I+jQ. In I+jQ this setting is applied to both I and Q channel inputs. It is not available unless the Baseband I/Q option (BBA) is installed.

Remote Command	<code>[:SENSE]:CORRection:IQ:I:GAIN <rel_ampl></code> <code>[:SENSE]:CORRection:IQ:I:GAIN?</code>
Restriction and Notes	Not available unless option BBA is installed
Example	Set the I Ext Gain to 10 dB <code>CORR:IQ:I:GAIN 10</code> Set the I Ext Gain to -10 dB (that is, a loss of 10 dB.) <code>CORR:IQ:I:GAIN -10</code>
Key Path	Input/Output, External Gain
Preset	0 dB This is unaffected by Preset but is set to 0 dB on a "Restore Input/Output Defaults" or "Restore System Defaults->All"
State Saved	Saved in instrument state.
Min	-100 dB
Max	100 dB
Readback Text	I Gain, <I Ext Gain> dB
Instrument S/W Revision	Prior to A.02.00

Q Ext Gain

This function affects only the Q channel input and only when the Input Path is not I+jQ. It is not

available unless the Baseband I/Q option (BBA) is installed.

Remote Command	[:SENSe]:CORRection:IQ:Q:GAIN <rel_ampl> [:SENSe]:CORRection:IQ:Q:GAIN?
Restriction and Notes	Not available unless option BBA is installed
Example	Set the Q Ext Gain to 10 dB CORR:IQ:Q:GAIN 10 Set the Q Ext Gain to -10 dB (that is, a loss of 10 dB.) CORR:IQ:Q:GAIN -10
Key Path	Input/Output, External Gain
Preset	0 dB This is unaffected by Preset but is set to 0 dB on a "Restore Input/Output Defaults" or "Restore System Defaults->All"
State Saved	Saved in instrument state.
Min	-100 dB
Max	100 dB
Readback Text	Q Gain, <I Ext Gain> dB
Instrument S/W Revision	Prior to A.02.00

Restore Input/Output Defaults

This selection causes the group of settings and data associated with **Input/Output** key to be a reset to their default values. This level of Restore System Defaults does not affect any other system settings or mode settings and does not cause a mode switch. All the features described in this section are reset using this key, including Input Corrections and Data (described in the Corrections section).

Example:	:SYST:DEF INP presets all the Input/Output variables to their factory default values.
Remote Command Notes:	Please refer to the Utility Functions for information about Restore System Defaults and the complete description of the :SYSTem:DEFAult INPut: command.
Key Path:	Input/Output
Instrument S/W Revision:	Prior to A.02.00

Data Source

Gives you the choice of either using a hardware input signal as the input or raw data stored in a data storage buffer from an earlier acquisition. You can also share raw data across certain measurements that support this feature. The measurements must be capable of storing raw data. There are three choices under this menu. You can select "Inputs" which is the same as selecting one of the inputs from the input

Input/Output

port, for example RF, AREF, I/Q, EXTMixer, or IFALign. Selecting "Capture Buffer" allows you to use data that has been stored earlier in the same measurement or from a previous measurement using the "Current Meas -> Capture Buffer" feature. Selecting "Recorded Data" allows you to playback long data capture records stored in the record buffer.

When you make a recording (see **Record Data Now** below) or when you recall a recording (see the Recall section) the data source is automatically set to Recorded Data. You can toggle the data source between Inputs and the current Recording (if there is one). That is, the recording remains in memory until it is replaced by a new recording, or the application is closed.

Remote Command: [:SENSe] :FEED:DATA INPut | STORed | RECorded
[:SENSe] :FEED:DATA?

Example: FEED:DATA REC
FEED:DATA?

Dependencies/Couplings: Not all inputs are available in all modes. Unavailable keys are grayed out.

Remote Command Notes: INPutS = Inputs
STORed = Capture Buffer
RECorded = Record Data Buffer

Preset: This is unaffected by Preset but is set to INPut on a "Restore Input/Output Defaults" or "Restore System Defaults->All"

State Saved: Saved in state

Key Path: **Input/Output**

Readback: Variable

Instrument S/W Revision: Prior to A.02.00

Inputs

Sets the measurement to use the input selections (RF, AREF, EXTMix, I/Q)

Example: FEED:DATA INP causes the measurement to look at the input selection

Key Path: **Input/Output, Data Source**

Readback: Inputs

Instrument S/W Revision: Prior to A.02.00

Capture Buffer

Some WCDMA and demod measurements support this feature. This allows sharing of the raw data across certain measurements. If you want to make another measurement on the same signal, you would store that raw data using the "Current Meas -> Capture Buffer" key. Then the data is available for the next measurement to use. You must have raw data stored in the instrument memory before the Capture Buffer choice is available for use.

If you switch to a measurement that does not support this feature, then the instrument switches to use "Inputs" and grays out this key. If the grayed out key is pressed, it generates a message.

Example: FEED:DATA STOR causes stored measurement data to be used with a different measurement that supports this.

Dependencies/Couplings: Grayed out in the SA measurement.

Key Path: **Input/Output, Data Source**

Readback: Stored Data

Instrument S/W Revision: Prior to A.02.00

Recorded Data

Directs the instrument to get data from the record data buffer in the measurement, rather than from the RF Input Signal.

Example: FEED:DATA REC causes the measurement to extract data from the record data buffer

Dependencies/Couplings: Grayed out in the SA measurement.

Key Path: **Input/Output, Data Source**

Readback: Recorded Data

Instrument S/W Revision: Prior to A.02.00

Current Meas -> Capture Buffer

Pressing this key stores the raw data of one measurement in the internal memory of the instrument where it can then be used by a different measurement by pressing "Stored Data". When raw data is stored, then data source selection switch automatically changes to "Stored Data". Stored raw data cannot be directly accessed by a user. There is no save/recall function to save the raw data in an external media. However if you want to get the stored raw data, you must first perform a measurement using the stored raw data. Now you can access the used raw data, which is the same as stored raw data, using the FETch or READ commands.

Remote Command: [:SENSE] :FEED:DATA:STORe

Example: FEED:DATA:STOR stores recorded data

Input/Output

Dependencies/Couplings:	Grayed out in the SA measurement.
Remote Command Notes:	This is command only, there is no query
Key Path:	Input/Output, Data Source
Instrument S/W Revision:	Prior to A.02.00

Record Data Now

This causes the data source to change to Inputs (if it is not already set) and a recording is made with the current instrument setup. The length of the recording must be specified in advance.

This key changes to **Abort Recording** once the recording process has started. It changes back when the recording is complete.

The following dialogs show the progress of the recording:

This key is also available in the Sweep/Control menu.

Remote Command	[:SENSe] :RECOrding :INITiate [:IMMediate]
Example	REC:INIT
Dependencies/Couplings	Changes Data source to Recorded Data. Grayed out in the SA measurement.
Remote Command Notes	This is command only, there is no query. See the Recall functionality to access previously saved data.
Key Path	Input/Output, Data Source
Mode	VSA
Instrument S/W Revision	Prior to A.02.00

Remote Command:	[:SENSe] :RECOrding :ABORt
Example:	REC:ABOR
Key Path:	Input/Output, Data Source
Remote Command Notes:	This is command only, there is no query. The command does nothing if it is sent when there is no recording in progress.
Instrument S/W Revision:	Prior to A.02.00

Record Length

This specifies the length of the next recording. (You cannot use this to modify the length of the current recording.) The length defaults to seconds, but you can also specify it in points at the current sample rate,

or in time records at the current time record length.

Remote Command [:SENSE]:RECORDing:LENGth <real>,SECOnds|RECOrds|POINts
 [:SENSE]:RECORDing:LENGth:STATe MAX|MANual
 [:SENSE]:RECORDing:LENGth:STATe?

Example REC:LENG 20,REC
 REC:LENG 4.1E-4,SEC
 REC:LENG:STAT MAX
 REC:LENG:STAT?

Remote Command Notes There is no default unit. The unit must be specified.
 The length command does not have a query form. Length information is queried using the two commands following this table.
 If set to MAX, all of the available "recording memory" is used.

Key Path **Input/Output, Data Source**
 Mode VSA
 Preset 50 Records, Manual
 State Saved No
 Min 0
 Max Depends on memory available
 Readback <value><Seconds|Points|Records>
 Instrument S/W Revision Prior to A.02.00

Remote Command [:SENSE]:RECORDing:LENGth:VALue?

Example REC:LENG:VAL?

Remote Command Notes Query Only
 Returns the first (numeric) parameter of the most recent [:SENSE]:RECORDing:LENGth command.

Mode VSA
 Preset 50 Records
 Instrument S/W Revision Prior to A.02.00

Remote Command [:SENSE]:RECORDing:LENGth:UNIT?

Example REC:LENG:UNIT?

Input/Output

Remote Command Notes	Query Only Returns the second parameter of the most recent [:SENSe]:RECORDing:LENGth command. Possible values are SEC REC POIN. If no second parameter was sent, then the return value is SEC.
Mode	VSA
Preset	RECORDs
Instrument S/W Revision	Prior to A.02.00

Corrections

This key accesses the Amplitude Corrections menu.

Amplitude Corrections arrays can be entered by you, sent over SCPI, or loaded from a file. They allow a user to correct the response of the analyzer for various use cases. The X-series supports four separate Corrections arrays, each of which can contain up to 2000 points. They can be turned on and off individually and any or all can be on at the same time.

Trace data is in absolute units and corrections data is in relative units, but we want to be able to display trace data at the same time as corrections data. Therefore we establish a reference line to be used while building or editing a Corrections table. The reference line is halfway up the display and represents 0 dB of correction. It is labeled "0 dB CORREC". It is drawn in blue (0,0,255) and is three pixels high.

Corrections data is always in dB. Whatever dB value appears in the correction table represents the correction to be applied to that trace at that frequency. So if a table entry shows 30 dB that means we ADD 30 dB to each trace to correct it before displaying it.

In zero span, where the frequency is always the center frequency of the analyzer, we apply the (interpolated) correction for the center frequency to all points in the trace. In the event where there are two correction amplitudes at the center frequency, we apply the first one in the table.

Note that the corrections are applied as the data is taken; therefore, a trace in **View** (Update Off) will not be affected by changes made to the corrections table after the trace is put in **View**.

Key Path	Input/Output, Corrections
Mode	SA, DVB-T/H, DTMB
Measurement	Swept SA
Preset	Corrections arrays are reset (deleted) by Restore Input/Output Defaults. They survive shutdown and restarting of the analyzer application, which means they will survive a power cycle.
Dependencies/Couplings	Amplitude correction may not be available in all modes; if a mode does not support amplitude correction, the Corrections key should be blanked while in that mode. If an application supports corrections but the current measurement does not, then the key should be grayed out in that measurement
Instrument S/W Revision	A.02.00

Select Correction

Specifies the selected correction. The term "selected correction" is used throughout this document to specify which correction will be affected by the functions.

Key Path	Input/Output, Corrections
Mode	SA
Preset	Set to Correction 1 by Restore Input/Output Defaults
Readback	Correction 1 Correction 2 Correction 3 Correction 4
Instrument S/W Revision	A.02.00

Correction On/Off

Turning the Selected Correction on allows the values in it to be applied to the data. This also automatically turns on "Apply Corrections" (sets it to ON), otherwise the correction would not take effect.

A new sweep is initiated if an amplitude correction is switched on or off. Note that changing, sending or loading corrections data does NOT directly initiate a sweep, however in general these operations will turn corrections on, which DOES initiate a sweep.

Remote Command:	[:SENSe] :CORRection :CSET [1] 2 3 4 [:STATe] ON OFF 1 0 [:SENSe] :CORRection :CSET [1] 2 3 4 [:STATe] ?
Example:	SENS:CORR:CSET1 ON
Dependencies/Couplings:	Turning this on automatically turns on "Apply Corrections" Only the first correction array (Correction 1) supports antenna units. When this array is turned on, and it contains an Antenna Unit other than "None", the Y Axis Unit of the analyzer is forced to that Antenna Unit. All other Y Axis Unit choices are grayed out. Note that this means that a correction file with an Antenna Unit can only be loaded into the Corrections 1 register. Consequently only for Correction 1 does the dropdown in the Recall dialog include .ant, and if an attempt is made to load a correction file into any other Correction register which DOES contain an antenna unit, a Mass Storage error is generated.
Preset:	Not affected by Preset. Set to OFF by Restore Input/Output Defaults
State Saved:	Saved in State
Key Path:	Input/Output, Corrections
Instrument S/W Revision:	A.02.00

Input/Output

Properties

Accesses a menu that lets you set the properties of the selected correction.

Key Path	Input/Output, Corrections
Instrument S/W Revision	A.02.00

Select Correction Specifies the selected correction. The term "selected correction" is used throughout this document to specify which correction will be affected by the functions.

Key Path	Input/Output, Corrections, Properties
Preset	Set to Correction 1 by Restore Input/Output Defaults
Readback	Correction 1 Correction 2 Correction 3 Correction 4
Instrument S/W Revision	A.02.00

Antenna Unit For devices (like antennae) which make measurements of field strength or flux density, the correction array should contain within its values the appropriate conversion factors such that, when the data on the analyzer is presented in dB μ V, the display is calibrated in the appropriate units. The "Antenna Unit" used for the conversion is contained within the corrections array database. It may be specified by you or loaded in from an external file or SCPI.

When an array with an Antenna Unit other than "None" is turned on, the Y Axis Unit of the analyzer is forced to that unit. When this array is turned on, and it contains an Antenna Unit other than "None", the Y Axis Unit of the analyzer is forced to that Antenna Unit., and all other Y Axis Unit choices are grayed out.

Antenna Unit does not appear in all Modes that support Corrections. Only the modes listed in the Mode row of the table below support Antenna Units.

Remote Command	<code>[:SENSe]:CORRection:CSET[1] 2 3 4:ANTenna[:UNIT] GAUSS PTESla UVM UAM NOConversion [:SENSe]:CORRection:CSET[1] 2 3 4:ANTenna[:UNIT]?</code>
-----------------------	--

Example	CORR:CSET:ANT GAUS
---------	--------------------

Dependencies/Couplings	Only the first correction array (Correction 1) supports antenna units. Note that this means that a correction file with an Antenna Unit can only be loaded into the Corrections 1 register. Consequently only for Correction 1 does the dropdown in the Recall dialog include.ant, and if an attempt is made to load a correction file into any other Correction register which DOES contain an antenna unit, a Mass Storage error is generated.
------------------------	---

Key Path	Input/Output, Corrections, Properties
Mode	SA
Preset	Unaffected by Preset. Set to NOC by Restore Input/Output Defaults

Input/Output

None Selects no antenna unit for this Correction set. Thus no Y Axis unit will be forced.

Example: :CORR:CSET4:ANT NOC
Key Path: **Input/Output, Corrections, Properties, Antenna Unit**
Readback: "None"
Instrument S/W Revision: A.02.00

Frequency Interpolation This setting controls how the correction values per-bucket are calculated. We interpolate between frequencies in either the logarithmic or linear scale.

This setting is handled and stored individually per correction set.

Remote Command: [:SENSe]:CORRection:CSET[1]|2|3|4:X:SPACing
LINear|LOGarithmic
[:SENSe]:CORRection:CSET[1]|2|3|4:X:SPACing?
Example: CORR:CSET:X:SPAC LIN
Preset: Unaffected by Preset. Set to Linear by Restore Input/Output Defaults
State Saved: Saved in State
Key Path: **Input/Output, Corrections, Properties**
Instrument S/W Revision: A.02.00

Description Sets an ASCII description field which will be stored in an exported file. Can be displayed in the active function area by selecting as the active function, if desired to be in a screen dump.

Remote Command: [:SENSe]:CORRection:CSET[1]|2|3|4:DESCription "text"
[:SENSe]:CORRection:CSET[1]|2|3|4:DESCription?
Example: :CORR:CSET1:DESC "11941A Antenna correction"
Remote Command Notes: 45 chars max; may not fit on display if max chars used
Preset: Unaffected by Preset. Set to empty by **Restore Input/Output Defaults**
State Saved: Saved in State
Key Path: **Input/Output, Corrections, Properties**
Instrument S/W Revision: A.02.00

Comment Sets an ASCII comment field which will be stored in an exported file. Can be displayed in

the active function area by selecting as the active function, if desired to be in a screen dump.

Remote Command:	[:SENSE] :CORRection:CSET[1] 2 3 4 :COMMeNt "text" [:SENSE] :CORRection:CSET[1] 2 3 4 :COMMeNt?
Example:	:CORR:CSET1:COMM "this is a comment"
Remote Command Notes:	45 chars max; may not fit on display if max chars used
Preset:	Unaffected by Preset. Set to empty by Restore Input/Output Defaults
State Saved:	Saved in State
Key Path:	Input/Output, Corrections, Properties
Instrument S/W Revision:	A.02.00

Edit

Invokes the integrated editing facility for this correction set.

When entering the menu, the editor window turns on, the selected correction is turned **On**, **Apply Corrections** is set to **On**, the amplitude scale is set to **Log**, and the Amplitude Correction (“Ampcor”) trace is displayed. The actual, interpolated correction trace is shown in green for the selected correction. Note that since the actual interpolated correction is shown, the correction trace may have some curvature to it. This trace represents only the correction currently being edited, rather than the total, accumulated amplitude correction for all amplitude corrections which are currently on, although the total, accumulated correction for all corrections which are turned on is still applied to the data traces.

Because corrections data is always in dB, but the Y-axis of the analyzer is in absolute units, it is necessary to establish a reference line for display of the Corrections data. The reference line is halfway up the display and represents 0 dB of correction. It is labeled “0 dB CORREC”. It is drawn in blue.

Corrections data is always in dB. Whatever dB value appears in the correction table represents the correction to be applied to that trace at that frequency. So if a table entry shows 30 dB that means we ADD 30 dB to each trace to correct it before displaying it. By definition all points are connected. If a gap is desired for corrections data, enter 0 dB.

Note that a well-designed Corrections array should start at 0 dB and end at 0 dB. This is because whatever the high end point is will be extended to the top frequency of the instrument, and whatever the low end point is will be extended down to 0 Hz. So for a Corrections array to have no effect outside its range, you should start and end the array at 0 dB.

NOTE The table editor will only operate properly if the analyzer is sweeping, because its updates are tied to the sweep system. Thus, you should not try to use the editor in single sweep, and it will be sluggish during compute-intensive operations like narrow-span FFT sweeps.

When exiting the edit menu (by using the **Return** key or by pressing an instrument front-panel key), the editor window turns off and the Ampcor trace is no longer displayed; however, **Apply Corrections** remains **On**, any correction that was on while in the editor remains on, and the amplitude scale returns to

Input/Output

its previous setting.

Corrections arrays are not affected by Preset, because they are in the Input/Output system. They also survive shutdown and restarting of the analyzer application, which means they will survive a power cycle.

Key Path	Input/Output, Corrections
Instrument S/W Revision	A.02.00

Navigate Lets you move through the table to edit the desired point

Key Path	Input/Output, Corrections, Edit
Notes	There is no value readback on the key
Instrument S/W Revision	A.02.00

Frequency Lets you edit the frequency of the current row.

Key Path	Input/Output, Corrections, Edit
Notes	There is no value readback on the key
Instrument S/W Revision	A.02.00

Amplitude Lets you edit the Amplitude of the current row.

Key Path	Input/Output, Corrections, Edit
Notes	There is no value readback on the key
Instrument S/W Revision	A.02.00

Insert Point Below Pressing this key inserts a point below the current point. The new point is a copy of the current point. And becomes the current point. The new point is not yet entered into the underlying table, and the data in the row is displayed in Light Gray.

Key Path	Input/Output, Corrections, Edit
Instrument S/W Revision	A.02.00

Delete Point This is an immediate action key. It will immediately delete the currently-selected point, whether or not that point is being edited, and select Navigate. The point following the currently-selected point (or the point preceding if there is none) will be selected.

Key Path	Input/Output, Corrections, Edit
Instrument S/W Revision	A.02.00

Scale X Axis Matches the X Axis to the selected Correction, as well as possible. Sets the Start and Stop

Frequency to contain the minimum and maximum Frequency of the selected Correction. The range between Start Frequency and Stop Frequency is 12.5% above the range between the minimum and maximum Frequency so that span exceeds this range by one graticule division on either side. If in zero-span, or there is no data in the Ampcor table, or the frequency range represented by the table is zero, no action is taken. Standard clipping rules apply, if the value in the table is outside the allowable range for the X axis.

Key Path **Input/Output, Corrections, Edit**
Instrument S/W Revision A.02.00

Delete Correction

Deletes the correction values for this set. When this key is pressed a prompt is placed on the screen that says “Please press Enter or OK key to delete correction. Press ESC or Cancel to close this dialog.” The deletion is only performed if you press OK or Enter; if so, after the deletion, the informational message “Correction deleted” appears in the MSG line.

Remote Command: [:SENSE]:CORRection:CSET[1|2|3|4]:DELeTe

Example: CORR:CSET:DEL
CORR:CSET1:DEL
CORR:CSET4:DEL

Key Path: **Input/Output, Corrections**

Instrument S/W Revision: A.02.00

Apply Corrections

Applies amplitude corrections which are marked as ON to the measured data. If this is set to NO, then no amplitude correction sets will be used, regardless of their individual on/off settings. If set to YES, then the corrections that are marked as ON (see [“Correction On/Off” on page 1093](#)) will be used.

Remote Command: [:SENSE]:CORRection:CSET:ALL[:STATe] ON|OFF|1|0
[:SENSE]:CORRection:CSET:ALL[:STATe]?

Example: SENS:CORR:CSET:ALL OFF
This command makes sure that no amplitude corrections are applied, regardless of their individual on/off settings.

Preset: Not affected by Preset. Set to OFF by Restore Input/Output Defaults

State Saved: Saved in state

Key Path: **Input/Output, Corrections**

Instrument S/W Revision: A.02.00

Input/Output

Delete All Corrections

Erases all correction values for all 4 Amplitude Correction sets.

When this key is pressed a prompt is placed on the screen that says “Please press Enter or OK key to delete all corrections. Press ESC or Cancel to close this dialog.” The deletion is only performed if you press OK or Enter; if so, after the deletion, the informational message “All Corrections deleted” appears in the MSG line.

Remote Command: [:SENSe]:CORRection:CSET:ALL:DELeTe

Example: CORR:CSET:ALL:DEL

Key Path: **Input/Output, Corrections**

Instrument S/W Revision: A.02.00

Remote Correction Data Set Commands

Set (Replace) Data (Remote Command Only) The command takes an ASCII series of alternating frequency and amplitude points, each value separated by commas.

The values sent in the command will totally replace all existing correction points in the specified set. An Ampcor array can contain 2000 points maximum.

Remote Command: [:SENSe]:CORRection:CSET[1]|2|3|4:DATA <freq>, <ampl>, .
. . .
[:SENSe]:CORRection:CSET[1]|2|3|4:DATA?

Example: CORR:CSET1:DATA 10000000,-1.0,20000000,1.0

This defines two correction points at (10 MHz, -1.0 dB) and (20 MHz, 1.0 dB) for correction set 1.

Preset: Empty after Restore Input/Output Defaults. Survives shutdown/restart of analyzer application (including power cycle)

State Saved: Saved in state

Min: Freq: 0 Hz
Amptd: -1000 dBm

Max: Freq: 1 THz
Amptd: +1000 dBm

Instrument S/W Revision: A.02.00

Merge Correction Data (Remote Command Only) The command takes an ASCII series of alternating frequency and amplitude points, each value separated by commas. The difference between this command and Set Data is that this merges new correction points into an existing set.

Any new point with the same frequency as an existing correction point will replace the existing point's amplitude with that of the new point.

An Ampcor array can contain 2000 total points, maximum.

Remote Command:	<code>[:SENSe]:CORRection:CSET[1] 2 3 4:DATA:MERGe <freq>, <ampl>, ...</code>
Example:	<code>CORR:CSET1:DATA:MERGE 15000000,-5.0,25000000,5.0</code> This adds two correction points at (15 MHz, -5.0 dB) and (25 MHz, 5.0 dB) to whatever values already exist in correction set 1.
Preset:	Empty after Restore Input/Output Defaults. Survives shutdown/restart of analyzer application (including power cycle)
Min:	Freq: 0 Hz Amptd: -1000 dBm
Max:	Freq: 1 THz Amptd: +1000 dBm
Instrument S/W Revision:	A.02.00

Freq Ref In

Specifies the frequency reference as being the internal reference, external reference or sensing the presence of an external reference.

When the frequency reference is set to internal, the internal 10 MHz reference is used even if an external reference is connected.

When the frequency reference is set to external, the instrument will use the external reference. However, if there is no external signal present, or it is not within the proper amplitude range, an error condition detected message is generated. When the external signal becomes valid, the error is cleared.

If Sense is selected, the instrument checks whether a signal is present at the external reference connector and will automatically switch to the external reference when a signal is detected. When no signal is present, it automatically switches to the internal reference. No message is generated as the reference switches between external and internal. The monitoring of the external reference occurs approximately on 1 millisecond intervals, and never occurs in the middle of a measurement acquisition, only at the end of the measurement (end of the request).

If for any reason the instrument's frequency reference is not able to obtain lock, Status bit 2 in the Questionable Frequency register will be true and an error condition detected message is generated. When lock is regained, Status bit 2 in the Questionable Frequency register will be cleared and an error message is cleared will be sent.

If an external frequency reference is being used, you must enter the frequency of the external reference if it is not exactly 10 MHz. The External Ref Freq key is provided for this purpose.

Remote Command:	<code>[:SENSe]:ROSCillator:SOURce:TYPE INTernal EXTernal SENSe [:SENSe]:ROSCillator:SOURce:TYPE?</code>
------------------------	---

Input/Output

Preset: This is unaffected by Preset but is set to SENSE on a "Restore Input/Output Defaults" or "Restore System Defaults->All".

State Saved: Saved in State.

Key Path: **Input/Output**

SCPI Status Bits/OPC Dependencies: STATus:QUESTionable:FREQuency bit 2 set if unlocked.

Instrument S/W Revision: Prior to A.02.00

Remote Command: [:SENSE]:ROSCillator:SOURce?

Remote Command Notes: The query [SENSE]:ROSCillator:SOURce? returns the current switch setting. This means:

1. If it was set to SENSE but there is no external reference so the instrument is actually using the internal reference, then this query returns INTERNAL and not SENSE.
2. If it was set to SENSE and there is an external reference present, the query returns EXTERNAL and not SENSE.
3. If it was set to EXTERNAL, then the query returns "EXTERNAL"
4. If it was set to INTERNAL, then the query returns INTERNAL

Preset: SENSE

Instrument S/W Revision: Prior to A.02.00

Remote Command: [:SENSE]:ROSCillator:SOURce INTERNAL|EXTERNAL

Instrument S/W Revision: Prior to A.02.00

Sense

The external reference is used if a valid signal is sensed at the Ext Ref input. Otherwise the internal reference is used.

Example: :ROSC:SOUR:TYPE SENS

Key Path: **Input/Output, Freq Ref In**

Readback: Sense

Instrument S/W Revision: Prior to A.02.00

Internal

The internal reference is used.

Example: :ROSC:SOUR:TYPE INT

Key Path: **Input/Output, Freq Ref In**
 Readback: Internal
 Instrument S/W Revision: Prior to A.02.00

External

The external reference is used.

Example: :ROSC:SOUR:TYPE EXT
 Key Path: **Input/Output, Freq Ref In**
 Readback: External
 Instrument S/W Revision: Prior to A.02.00

Ext Ref Freq

This key tells the analyzer the frequency of the external reference. When the external reference is in use (either because the reference has been switched to External or because the Reference has been switched to Sense and there is a valid external reference present) this information is used by the analyzer to determine the internal settings needed to lock to that particular external reference signal.

For the instrument to stay locked, the value entered must be within 5 ppm of the actual external reference frequency. So it is important to get it close, or you risk an unlock condition.

Note that this value only affects the instrument's ability to lock. It does not affect any calculations or measurement results. See "Freq Offset" in the Frequency section for information on how to offset frequency values.

Remote Command: [:SENSe]:ROSCillator:EXTErnal:FREQuency <freq>
 [:SENSe]:ROSCillator:EXTErnal:FREQuency?

Example: ROSC:EXT:FREQ 20 MHz sets the external reference frequency to 20 MHz, but does not select the external reference.
 ROSC:SOUR:TYPE EXT selects the external reference.

Preset: This is unaffected by Preset but is set to 10 MHz on a "Restore Input/Output Defaults" or "Restore System Defaults->All"

Min: EXA: 10 MHz
 MXA: 1 MHz

Max: EXA: 10 MHz
 MXA: 50 MHz

Key Path: **Input/Output, Freq Ref In**
 Default Unit: Hz
 Instrument S/W Revision: Prior to A.02.00

External Ref Coupling

Only appears with option ERC installed and licensed.

This function lets you couple the sweep system of the analyzer to the state of the External Reference. If **Normal** is selected, data acquisition proceeds regardless of the state of the External Reference. When you select **Ext Ref Out Of Range Stops Acquisition**, the data acquisition (sweep or measurement) stops when either the "521, External ref out of range" or the "503, Frequency Reference unlocked" error is asserted. Note that this will only take place if the **Freq Ref In** selection is **External**.

With the acquisition stopped, the data display will stop updating (even if this occurs in the middle of a sweep or measurement) and no data will be returned to a READ? or MEASure? query; that is to say, these queries will not complete because the analyzer will not respond to them. Furthermore, no response will be generated to a *WAI? or *OPC? query.

Proper SCPI sequences are shown below, which will always fail to return if the acquisition stops during the requested sweep or measurement. Note that, for predictable operation of this function, it is best to operate the analyzer in single measurement mode (INIT:CONT OFF), because if operating in continuous mode, the analyzer may respond to the above queries even after the acquisition stops, with data left over from the previous acquisition.

```
:INIT:CONT OFF
```

```
:INIT:IMM;*OPC?
```

```
--
```

```
:INIT:CONT OFF
```

```
:INIT:IMM;*WAI?
```

```
--
```

```
:INIT:CONT OFF
```

```
:READ?
```

```
--
```

```
:INIT:CONT OFF
```

```
:MEASure?
```

When the acquisition ceases, in addition to the error condition(s) described above, an error message will be generated informing you that the acquisition has ceased due to an invalid external reference. This message will stay on the screen while the acquisition is suspended.

External reference problem.
 Data acquisition suspended.
 To resume data acquisition, fix the
 problem and press the Restart key
 OR
 Press the following keys:
 Input/Output, More 1 of 2, Freq Ref In,
 External Ref Coupling, Normal
 OR
 Input/Output, More 1 of 2,
 Freq Ref In, Internal

If you press the Restart key this message will be taken off the screen and a new acquisition will be attempted; if the External Reference problem persists the message will go right back up. You can also take the message down by changing back to the **Normal** setting of Sweep/Ext Ref Coupling, or by pressing **Freq Ref In, Internal**, or **Freq Ref In, Sense**, or **Restore Input/Output Defaults**.

The setting of **External Ref Coupling** is persistent across power-cycling and is not reset with **Preset**. It is reset to the default state (**Normal**) when **Restore Input/Output Defaults** is invoked, which will also restart normal data acquisition.

The detection of invalid external reference is under interrupt processing. If the external reference becomes invalid then returns to valid in too short a time, no error condition will be detected or reported and therefore the acquisition will not be stopped.

Remote Command	[:SENSE]:ROSCillator:COUpling NORMal NACquisition [:SENSe]:ROSCillator:COUpling?
Mode	All
Preset	This setting is persistent: it survives power-cycling or Preset and is reset with Restore Input/Output defaults.
State Saved	Not saved in State
Readback	Normal Stop Acq
Key Path:	Input/Output, Freq Ref In
Instrument S/W Revision	A.02.00

Output Config

Accesses keys that configure various output settings, like the frequency reference output, trigger output and analog output.

Key Path	Input/Output
Instrument S/W Revision	Prior to A.02.00

Input/Output

Trig Out (1 and 2)

Select the type of output signal that will be output from the rear panel Trig 1 Out or Trig 2 Out connectors.

Remote Command: :TRIGger | TRIGger1 | TRIGger2[:SEquence] :OUTPut
HSWP | MEASuring | MAIN | GATE | GTRigger | OEVEN
:TRIGger | TRIGger1 | TRIGger2[:SEquence] :OUTPut?

Example: TRIG:OUTP HSWP

Preset: Trigger 1: Sweeping (HSWP)
 Trigger 2: Gate

This is unaffected by Preset but is preset to the above values on a "Restore Input/Output Defaults" or "Restore System Defaults->All"

State Saved: Saved in instrument state

Key Path: **Input/Output, Output Config**

Instrument S/W Revision: Prior to A.02.00

Polarity Sets the output to the Trig 1 Out connector to trigger on either the positive or negative polarity.

Remote Command: :TRIGger | TRIGger1 | TRIGger2[:SEquence] :OUTPut :POLarity
POSitive | NEGative
:TRIGger | TRIGger1 | TRIGger2[:SEquence] :OUTPut :POLarity?

Example: TRIG1:OUTP:POL POS

Preset: This is unaffected by Preset but is set to POSitive on a "Restore Input/Output Defaults" or "Restore System Defaults->All"

State Saved: Saved in state

Key Path: **Input/Output, Output Config, Trig 1 Output**

Instrument S/W Revision: Prior to A.02.00

Sweeping (HSWP) Selects the Sweeping trigger signal to be output to the Trig 1 Out connector. This signal has historically been known as "HSWP" but care should be taken to understand that in this analyzer, its function does not exactly match other products behavior.

Example: TRIG1:OUTP HSWP

Key Path: **Input/Output, Output Config, Trig 1 Output**

Readback: Sweeping

Instrument S/W Revision: Prior to A.02.00

Measuring Selects the Measuring trigger signal to be output to the Trig 1 Out connector. This signal is true while the Measuring status bit is true.

Example: TRIG1:OUTP MEAS
 Key Path: **Input/Output, Output Config, Trig 1 Output**
 Readback: Measuring
 Instrument S/W Revision: Prior to A.02.00

Main Trigger Selects the current instrument trigger signal to be output to the Trig 1 Out connector.

Example: TRIG1:OUTP MAIN
 Key Path: **Input/Output, Output Config, Trig 1 Output**
 Readback: Main Trigger
 Instrument S/W Revision: Prior to A.02.00

Gate Trigger Selects the gate trigger signal to be output to the Trig 1 Out connector. This is the source of the gate timing, not the actual gate signal.

Example: TRIG1:OUTP GTR
 Key Path: **Input/Output, Output Config, Trig 1 Output**
 Readback: Gate Trigger
 Instrument S/W Revision: Prior to A.02.00

Gate Selects the gate signal to be output to the Trig 1 Out connector. The gate signal has been delayed and its length determined by delay and length settings. When the polarity is positive, a high on the Trig 1 Out represents the time the gate is configured to pass the signal.

Example: TRIG1:OUTP GATE
 Key Path: **Input/Output, Output Config, Trig 1 Output**
 Readback: Gate
 Instrument S/W Revision: Prior to A.02.00

Odd/Even Trace Point Selects either the odd or even trace points as the signal to be output to the Trig 1 Out connector when performing swept spectrum analysis. When the polarity is positive, this output goes high during the time the analyzer is sweeping past the first point (Point 0) and every other following trace point. The opposite is true if the polarity is negative.

Example: TRIG1:OUTP OEV
 Key Path: **Input/Output, Output Config, Trig 1 Output**

Input/Output

Readback: Odd/Even
Instrument S/W Revision: Prior to A.02.00

Off Selects no signal to be output to the Trig 1 Out connector.

Example: TRIG1:OUTP OFF
Key Path: **Input/Output, Output Config, Trig 1 Output**
Readback: Off
Instrument S/W Revision: Prior to A.02.00

Digital Bus

Opens a menu that allows you to select options for configuring the digital bus output(s) of the analyzer.

Key Path **Input/Output, Output Config**
Instrument S/W Revision Prior to A.02.00

Bus Out The Digital Bus is a connector located on the rear panel of the instrument. It is a unidirectional link of real time raw ADC data at a 90 MHz rate. No corrections are applied. The ADC is sampling a 22.5 MHz IF. When Bus Out is on, all acquisitions are streamed to the output port including acquisitions for internal purposes such as Alignment; internal processing and routing of acquisitions continues as usual and is unaffected by the state of Bus Out. This port is intended for use with the Agilent N5105 and N5106 products only. It is not available for general purpose use.

Remote Command :OUTPut:DBUS[1][:STATE] ON|OFF|1|0
:OUTPut:DBUS[1][:STATE]?

Example OUTP:DBUS ON

Key Path **Input/Output, Output Config, Digital Bus**

Scope Mode Global

Preset This is unaffected by Preset but is set to Off on a "Restore Input/Output Defaults" or "Restore System Defaults -> All"

State Saved Saved in instrument state.

Instrument S/W Revision Prior to A.02.00

I/Q Cal Out

The Baseband I/Q "Cal Out" port can be turned on with either a 1 kHz or a 250 kHz square wave. This can be turned on independent of the input selection. A Preset will reset this to Off.

Remote Command :OUTPut:IQ:OUTPut IQ1|IQ250|OFF
:OUTPut:IQ:OUTPut?

Dependencies/Couplings	An I/Q Cable Calibration or an I/Q Probe Calibration will change the state of the Cal Out port as needed by the calibration routine. When the calibration is finished the I/Q Cal Out is restored to the pre-calibration state.
Example	OUTP:IQ:OUTP IQ1
Key Path	Input/Output, Output Config
Preset	Off
State Saved	Saved in instrument state.
Range	1 kHz Square Wave 250 kHz Square Wave Off
Readback Text	1 kHz 250 kHz Off
Instrument S/W Revision	Prior to A.02.00

1 kHz Square Wave Turn on the 1 kHz square wave signal at the Cal Out port. This choice is only available with option BBA.

Key Path	Input/Output, Output Config, I/Q Cal Out
Readback	I/Q 1kHz
Instrument S/W Revision	Prior to A.02.00

250 kHz Square Wave Turn on the 250 kHz square wave signal at the Cal Out port. This choice is only available with option BBA.

Key Path	Input/Output, Output Config, I/Q Cal Out
Readback	I/Q 250kHz
Instrument S/W Revision	Prior to A.02.00

Off Turn off the signal at the Cal Out port. This choice is only available with option BBA.

Key Path	Input/Output, Output Config, I/Q Cal Out
Readback	Off
Instrument S/W Revision	Prior to A.02.00

I/Q Guided Calibration

Calibrating the Baseband I/Q ports requires several steps and manual connections. The Guided Calibration will interactively step a user through the required steps, displaying diagrams to help with the connections. The steps will vary depending on the setup.

In the Guided Calibration windows, the date and time of the last calibration are displayed. If any of the items listed are displayed in yellow, this indicates that the calibration for that item is inconsistent with the latest calibration, and you should complete the entire calibration process before you exit the calibration.

Input/Output

I/Q Isolation Calibration

The I/Q Isolation Calibration must be run before calibrating any port with either the I/Q Cable Calibration or I/Q Probe Calibration. This calibration is performed with nothing connected to any of the front panel I/Q ports. This is the first step in both the I/Q Cable Calibration and the I/Q Probe Calibration.

Next Perform the I/Q Isolation calibration.

Remote Command	:CALibration:IQ:ISOLation
Restriction and Notes	All front panel I/Q ports must not be connected to anything.
Remote Command Notes	All cables and probes should be disconnected from the I/Q ports before issuing the SCPI command.
Example	CAL:IQ:ISOL
Key Path	Input/Output, I/Q, I/Q Cable Calibration
State Saved	No.
Instrument S/W Revision	Prior to A.02.00

Exit Exit the calibration procedure. All ports calibrated before pressing Exit will use the newly acquired calibration data.

Restriction and Notes	Using the Exit button will not restore the calibration data to the state prior to entering the guided calibration. Once a port is calibrated the data is stored immediately and the only way to change it is to redo the calibration step. When the calibration may be left in an inconsistent state, a confirmation dialog will be displayed (see “Exit Confirmation” on page 1120).
Key Path	Input/Output, I/Q, I/Q Cable Calibration
Instrument S/W Revision	Prior to A.02.00

I/Q Isolation Calibration Time (Remote Only)

Return the last date and time that the I/Q Isolation Calibration was performed. This is a remote query command only.

Remote Command:	:CALibration:IQ:ISOLation:TIME?
Example:	:CAL:IQ:ISOL:TIME?
Restriction and Notes:	This returns 6 integer values: year, month, day, hour, minute, second. When no calibration has been performed, all values will be 0.
Instrument S/W Revision:	A.02.00

I/Q Cable Calibration

The I/Q cable calibration creates correction data for each of the front panel I/Q ports. This calibration

data is used whenever no probe specific calibration data is available. It is important that all ports are calibrated using the same short BNC cable so that the data is comparable from port to port.

The guided calibration (front panel only) will show connection diagrams and guide you through the isolation calibration and calibrating each port. The calibration data for each port is stored separately, so as soon as a port is calibrated that data is saved and will be used. If a user presses "Exit" to exit the calibration process, the data for the ports already completed will still be used. It is recommended that a calibration be completed once started, or if exited, that it be properly done before the next use of the I/Q ports. The "Next" button will perform the calibration for the current port and then proceed to the next step in the calibration procedure. The "Back" button will return to the prior port in the procedure. Both keys and dialog buttons are supplied for ease of use. The dialog buttons are for mouse use and the keys for front panel use.

The calibration can also be done via SCPI, but no connection diagrams will be shown. You will have to make the correct connections before issuing each port calibration command. Again, it is recommended that all ports be calibrated at the same time.

The instrument state remains as it was prior to entering the calibration procedure except while a port is actually being calibrated. Once a port is calibrated it returns to the prior state. A port calibration is in process only from the time the "Next" button is pressed until the next screen is shown. For SCPI, this corresponds to the time from issuing the CAL:IQ:FLAT:I|IB|Q|QB command until the operation is complete.

For example, if the prior instrument state is Cal Out = Off, Input = I+jQ, and Differential = Off, then up until the time the "Next" button is pressed the I Input and Q Input LEDs are on and the Cal Out, I-bar Input and Q-bar Input LEDs are off. Once the "Next" button is pressed for the I port calibration, only the Cal Out and I Input LEDs will be on and the others will be off. When the screen progresses to the next step ("Next" button again enabled), the prior state is restored and only the I Input and Q Input LEDs are on (Cal Out is off again).

The last calibration date and time for each port will be displayed. Any calibrations that are more than a day older than the most recent calibration will be displayed with the color amber.

I Port The I port calibration is performed with the front panel's I port connected via a short BNC cable to the Cal Out port. The guided calibration will show a diagram of the required connections.

Back Return to the prior step in the calibration procedure.

Key Path	Input/Output, I/Q, Q Setup, Q Probe, Calibrate
Instrument S/W Revision	Prior to A.02.00

Next Perform the I port calibration.

Remote Command	:CALibration:IQ:FLATness:I
Restriction and Notes	The recommended procedure is to use the same BNC cable to calibrate all I/Q ports. All I/Q ports should be calibrated sequentially during the procedure. The calibration data is saved as soon as the port is calibrated and will survive power cycles. It is not reset by any preset or restore data commands.

Input/Output

Remote Command Notes	The I port must be connected to the Cal Out port before issuing the SCPI command.
Example	CAL:IQ:FLAT:I
Key Path	Input/Output, I/Q, I/Q Cable Calibration
State Saved	No.
Instrument S/W Revision	Prior to A.02.00

Exit Exit the calibration procedure. All ports calibrated before pressing Exit will use the newly acquired calibration data.

Restriction and Notes	Using the Exit button will not restore the calibration data to the state prior to entering the guided calibration. Once a port is calibrated the data is stored immediately and the only way to change it is to redo the calibration step. When the calibration may be left in an inconsistent state, a confirmation dialog will be displayed (see “Exit Confirmation” on page 1120).
Key Path	Input/Output, I/Q, I/Q Cable Calibration
Instrument S/W Revision	Prior to A.02.00

I-bar Port The I-bar port calibration is performed with the front panel's I-bar port connected via a short BNC cable to the Cal Out port. The guided calibration will show a diagram of the required connections.

Back Return to the prior step in the calibration procedure.

Restriction and Notes	Using the Back button will not restore the calibration data to a prior state. Once a port is calibrated the data is stored immediately and the only way to change it is to redo the calibration step. The Back button allows you to go back to a prior step to redo that calibration step.
Key Path	Input/Output, I/Q, I/Q Cable Calibration
Instrument S/W Revision	Prior to A.02.00

Next Perform the I-bar port calibration.

Remote Command	:CALibration:IQ:FLATness:IBAR
Restriction and Notes	The recommended procedure is to use the same BNC cable to calibrate all I/Q ports. All I/Q ports should be calibrated sequentially during the procedure. The calibration data is saved as soon as the port is calibrated and will survive power cycles. It is not reset by any preset or restore data commands.
Remote Command Notes	The I-bar port must be connected to the Cal Out port before issuing the SCPI command.
Example	CAL:IQ:FLAT:IBAR

Key Path	Input/Output, I/Q, I/Q Cable Calibration
State Saved	No
Instrument S/W Revision	Prior to A.02.00

Exit Exit the calibration procedure. All ports calibrated before pressing Exit will use the newly acquired calibration data.

Restriction and Notes	Using the Exit button will not restore the calibration data to the state prior to entering the guided calibration. Once a port is calibrated the data is stored immediately and the only way to change it is to redo the calibration step. When the calibration may be left in an inconsistent state, a confirmation dialog will be displayed (see “Exit Confirmation” on page 1120).
-----------------------	---

Key Path	Input/Output, I/Q, I/Q Cable Calibration
Instrument S/W Revision	Prior to A.02.00

Q Port The Q port calibration is performed with the front panel's Q port connected via a short BNC cable to the Cal Out port. The guided calibration will show a diagram of the required connections.

Back Return to the prior step in the calibration procedure.

Restriction and Notes	Using the Back button will not restore the calibration data to a prior state. Once a port is calibrated the data is stored immediately and the only way to change it is to redo the calibration step. The Back button allows you to go back to a prior step to redo that calibration step.
-----------------------	--

Key Path	Input/Output, I/Q, I/Q Cable Calibration
Instrument S/W Revision	Prior to A.02.00

Next Perform the Q port calibration.

Remote Command :CALibration:IQ:FLATness:Q

Restriction and Notes	The recommended procedure is to use the same BNC cable to calibrate all I/Q ports. All I/Q ports should be calibrated sequentially during the procedure. The calibration data is saved as soon as the port is calibrated and will survive power cycles. It is not reset by any preset or restore data commands.
-----------------------	--

Remote Command Notes The Q port must be connected to the Cal Out port before issuing the SCPI command.

Example CAL:IQ:FLAT:Q

Key Path	Input/Output, I/Q, I/Q Cable Calibration
State Saved	No
Instrument S/W Revision	Prior to A.02.00

Input/Output

Exit Exit the calibration procedure. All ports calibrated before pressing Exit will use the newly acquired calibration data.

Restriction and Notes	Using the Exit button will not restore the calibration data to the state prior to entering the guided calibration. Once a port is calibrated the data is stored immediately and the only way to change it is to redo the calibration step. When the calibration may be left in an inconsistent state, a confirmation dialog will be displayed (see “Exit Confirmation” on page 1120).
Key Path	Input/Output, I/Q, I/Q Cable Calibration
Instrument S/W Revision	Prior to A.02.00

Q-bar Port The Q-bar port calibration is performed with the front panel's Q-bar port connected via a short BNC cable to the Cal Out port. The guided calibration will show a diagram of the required connections.

Back Return to the prior step in the calibration procedure.

Restriction and Notes	Using the Back button will not restore the calibration data to a prior state. Once a port is calibrated the data is stored immediately and the only way to change it is to redo the calibration step. The Back button allows you to go back to a prior step to redo that calibration step.
Key Path	Input/Output, I/Q, I/Q Cable Calibration
Instrument S/W Revision	Prior to A.02.00

Next Perform the Q-bar port calibration.

Remote Command	<code>:CALibration:IQ:FLATness:QBAR</code>
Restriction and Notes	The recommended procedure is to use the same BNC cable to calibrate all I/Q ports. All I/Q ports should be calibrated sequentially during the procedure. The calibration data is saved as soon as the port is calibrated and will survive power cycles. It is not reset by any preset or restore data commands.
Remote Command Notes	The Q-bar port must be connected to the Cal Out port before issuing the SCPI command.
Example	<code>CAL:IQ:FLAT:QBAR</code>
Key Path	Input/Output, I/Q, I/Q Cable Calibration
State Saved	No
Instrument S/W Revision	Prior to A.02.00

Exit Exit the calibration procedure. All ports calibrated before pressing Exit will use the newly acquired

calibration data.

Restriction and Notes	Using the Exit button will not restore the calibration data to the state prior to entering the guided calibration. Once a port is calibrated the data is stored immediately and the only way to change it is to redo the calibration step. When the calibration may be left in an inconsistent state, a confirmation dialog will be displayed (see “Exit Confirmation” on page 1120).
Key Path	Input/Output, I/Q, I/Q Cable Calibration
Instrument S/W Revision	Prior to A.02.00

I/Q Cable Calibration Time (Remote Only) Return the last date and time that the I/Q Cable Calibration was performed for a specific port. This is a remote query command only.

Remote Command:	:CALibration:IQ:FLATness:I IBAR Q QBAR:TIME?
Example:	:CAL:IQ:FLAT:I:TIME?
Restriction and Notes:	This returns 6 integer values: year, month, day, hour, minute, second. When no calibration has been performed, all values will be 0.
Instrument S/W Revision:	A.02.00

I/Q Probe Calibration

The I/Q probe calibration creates correction data for one of the front panel I/Q channels. When the probe has EEPROM identification, the data is unique to that specific probe. When the probe does not have EEPROM identification, the data will be used for all probes of the same type. The data is also unique to the channel, so calibration data for the I channel will not be used for the Q channel and vice versa.

The guided calibration (front panel only) will show connection diagrams and guide you through the I/Q Isolation Calibration and through calibrating each port. The calibration data for each port is stored separately, so as soon as a port is calibrated that data is saved and will be used. If a user presses "Exit" to exit the calibration process, the data for the port already completed will still be used. It is recommended that a calibration be completed once started, or if exited, that it be properly done before the next use of the probe. The "Next" button will perform the calibration for the current port and then proceed to the next step in the calibration procedure. The "Back" button will return to the prior port in the procedure. Both keys and dialog buttons are supplied for ease of use. The dialog buttons are for mouse use and the keys for front panel use.

The calibration can also be done via SCPI, but no connection diagrams will be shown. You will have to make the correct connections before issuing each port calibration command. Again, it is recommended that all ports be calibrated at the same time.

For Active probes or when Differential is Off, only the main port is calibrated, otherwise both the main and complementary ports are calibrated.

The instrument state remains as it was prior to entering the calibration procedure except while a port is actually being calibrated. Once a port is calibrated it returns to the prior state. A port calibration is in process only from the time the "Next" button is pressed until the next screen is shown. For SCPI, this corresponds to the time from issuing the CAL:IQ:PROB:I|IB|Q|QB command until the operation is

Input/Output

complete.

For example, if the prior instrument state is Cal Out = Off, Input = I+jQ, and Differential = Off, then up until the time the "Next" button is pressed the I Input and Q Input LEDs are on and the Cal Out, I-bar Input and Q-bar Input LEDs are off. Once the "Next" button is pressed for the I port calibration, only the Cal Out and I Input LEDs will be on and the others will be off. When the screen progresses to the next step ("Next" button again enabled), the prior state is restored and only the I Input and Q Input LEDs are on (Cal Out is off again).

The last calibration date and time for each relevant port will be displayed. For passive probes with Differential On, any calibration that is more than a day older than the most recent calibration will be displayed with the color amber.

I Port The I port calibration is performed with the probe body attached to the front panel's I port and the probe tip connected via an adapter to the Cal Out port. The guided calibration will show a diagram of the required connections.

Show Adapter Show a connection diagram and instructions for the probe and adapter. See ["Show Adapter Screen" on page 1120](#).

Restriction and Notes	Either a passive or an active probe adapter diagram will be shown, depending on the type of probe attached.
Key Path	Input/Output, I/Q, I Setup, I Probe, Calibrate
Instrument S/W Revision	Prior to A.02.00

Back Return to the prior step in the calibration procedure.

Key Path	Input/Output, I/Q, Q Setup, Q Probe, Calibrate
Instrument S/W Revision	Prior to A.02.00

Next Perform the I port calibration.

Remote Command	<code>:CALibration:IQ:PROBe:I</code>
Remote Command Notes	The I port must be connected to the Cal Out port before issuing the SCPI command. The calibration data is saved as soon as the port is calibrated and will survive power cycles. It is not reset by any preset or restore data commands.
Example	<code>CAL:IQ:PROB:I</code>
Key Path	Input/Output, I/Q, I Setup, I Probe, Calibrate
State Saved	No
Instrument S/W Revision	Prior to A.02.00

Exit Exit the calibration procedure. All ports calibrated before pressing Exit will use the newly acquired

calibration data.

Restriction and Notes	Using the Exit button will not restore the calibration data to the state prior to entering the guided calibration. Once a port is calibrated the data is stored immediately and the only way to change it is to redo the calibration step. When the calibration may be left in an inconsistent state, a confirmation dialog will be displayed (see “Exit Confirmation” on page 1120).
Key Path	Input/Output, I/Q, I Setup, I Probe, Calibrate
Instrument S/W Revision	Prior to A.02.00

I-bar Port The I-bar port calibration is performed with the probe body attached to the front panel's I-bar port and the probe tip connected via an adapter to the Cal Out port. The I-bar probe calibration is only available for passive probes with Differential On. The guided calibration will show a diagram of the required connections.

Show Adapter Show a connection diagram and instructions for the probe and adapter. See [“Show Adapter Screen” on page 1120](#).

Restriction and Notes	Either a passive or an active probe adapter diagram will be shown, depending on the type of probe attached.
Key Path	Input/Output, I/Q, I Setup, I Probe, Calibrate
Instrument S/W Revision	Prior to A.02.00

Back Return to the prior step in the calibration procedure.

Restriction and Notes	Using the Back button will not restore the calibration data to a prior state. Once a port is calibrated the data is stored immediately and the only way to change it is to redo the calibration step. The Back button allows you to go back to a prior step to redo that calibration step.
Key Path	Input/Output, I/Q, I Setup, I Probe, Calibrate
Instrument S/W Revision	Prior to A.02.00

Next Perform the I-bar port calibration.

Remote Command	:CALibration:IQ:PROBe:IBar
Remote Command Notes	The I-bar port must be connected to the Cal Out port before issuing the SCPI command. The calibration data is saved as soon as the port is calibrated and will survive power cycles. It is not reset by any preset or restore data commands.
Example	CAL:IQ:PROB:IB
Key Path	Input/Output, I/Q, I Setup, I Probe, Calibrate
State Saved	No

Input/Output

Instrument S/W Revision Prior to A.02.00

Exit Exit the calibration procedure. All ports calibrated before pressing Exit will use the newly acquired calibration data.

Restriction and Notes Using the Exit button will not restore the calibration data to the state prior to entering the guided calibration. Once a port is calibrated the data is stored immediately and the only way to change it is to redo the calibration step.

When the calibration may be left in an inconsistent state, a confirmation dialog will be displayed (see [“Exit Confirmation” on page 1120](#)).

Key Path **Input/Output, I/Q, I Setup, I Probe, Calibrate**

Instrument S/W Revision Prior to A.02.00

Q Port The Q port calibration is performed with the probe body attached to the front panel's Q port and the probe tip connected via an adapter to the Cal Out port. The guided calibration will show a diagram of the required connections.

Show Adapter Show a connection diagram and instructions for the probe and adapter. See [“Show Adapter Screen” on page 1120](#).

Restriction and Notes Either a passive or an active probe adapter diagram will be shown, depending on the type of probe attached.

Key Path **Input/Output, I/Q, Q Setup, Q Probe, Calibrate**

Instrument S/W Revision Prior to A.02.00

Back Return to the prior step in the calibration procedure.

Key Path **Input/Output, I/Q, Q Setup, Q Probe, Calibrate**

Instrument S/W Revision Prior to A.02.00

Next Perform the Q port calibration.

Remote Command :CALibration:IQ:PROBe:Q

Remote Command Notes The Q port must be connected to the Cal Out port before issuing the SCPI command.

The calibration data is saved as soon as the port is calibrated and will survive power cycles. It is not reset by any preset or restore data commands.

Example CAL:IQ:PROB:Q

Key Path **Input/Output, I/Q, Q Setup, Q Probe, Calibrate**

State Saved No

Instrument S/W Revision Prior to A.02.00

Exit Exit the calibration procedure. All ports calibrated before pressing Exit will use the newly acquired calibration data.

Restriction and Notes	Using the Exit button will not restore the calibration data to the state prior to entering the guided calibration. Once a port is calibrated the data is stored immediately and the only way to change it is to redo the calibration step. When the calibration may be left in an inconsistent state, a confirmation dialog will be displayed (see “Exit Confirmation” on page 1120).
Key Path	Input/Output, I/Q, Q Setup, Q Probe, Calibrate
Instrument S/W Revision	Prior to A.02.00

Q-bar Port The Q-bar port calibration is performed with the probe body attached to the front panel's Q-bar port and the probe tip connected via an adapter to the Cal Out port. The Q-bar probe calibration is only available for passive probes with Differential On. The guided calibration will show a diagram of the required connections.

Show Adapter Show a connection diagram and instructions for the probe and adapter. See [“Show Adapter Screen” on page 1120](#).

Restriction and Notes	Either a passive or an active probe adapter diagram will be shown, depending on the type of probe attached.
Key Path	Input/Output, I/Q, Q Setup, Q Probe, Calibrate
Instrument S/W Revision	Prior to A.02.00

Back Return to the prior step in the calibration procedure.

Restriction and Notes	Using the Back button will not restore the calibration data to a prior state. Once a port is calibrated the data is stored immediately and the only way to change it is to redo the calibration step. The Back button allows you to go back to a prior step to redo that calibration step.
Key Path	Input/Output, I/Q, Q Setup, Q Probe, Calibrate
Instrument S/W Revision	Prior to A.02.00

Next Perform the Q-bar port calibration.

Remote Command	<code>:CALibration:IQ:PROBe:QBar</code>
Remote Command Notes	The Q-bar port must be connected to the Cal Out port before issuing the SCPI command. The calibration data is saved as soon as the port is calibrated and will survive power cycles. It is not reset by any preset or restore data commands.
Example	<code>CAL:IQ:PROB:QB</code>
Key Path	Input/Output, I/Q, Q Setup, Q Probe, Calibrate

Input/Output

State Saved	No
Instrument S/W Revision	Prior to A.02.00

Exit Exit the calibration procedure. All ports calibrated before pressing Exit will use the newly acquired calibration data.

Restriction and Notes	Using the Exit button will not restore the calibration data to the state prior to entering the guided calibration. Once a port is calibrated the data is stored immediately and the only way to change it is to redo the calibration step. When the calibration may be left in an inconsistent state, a confirmation dialog will be displayed (see “Exit Confirmation” on page 1120).
Key Path	Input/Output, I/Q, Q Setup, Q Probe, Calibrate
Instrument S/W Revision	Prior to A.02.00

Show Adapter Screen When one of the Probe Calibration Show Adapter buttons is pressed, a diagram of the probe with its adapter will be shown. Depending on the type of probe attached, either the Passive Probe Adapter or the Active Probe Adapter diagram will be shown.

I/Q Probe Calibration Time (Remote Only) Return the last date and time that the I/Q Probe Calibration was performed for a specific port. This is a remote query command only.

Remote Command:	<code>:CALibration:IQ:PROBe:I IBAR Q QBAR:TIME?</code>
Example:	<code>:CAL:IQ:PROB:I:TIME?</code>
Restriction and Notes:	This returns 6 integer values: year, month, day, hour, minute, second. When no calibration has been performed, all values will be 0. The value is specific to both the port and probe, so the value will change as probes are connected or disconnected.
Instrument S/W Revision:	A.02.00

Exit Confirmation

When Exit is pressed on one during one of the calibration routines, the calibration may be in an inconsistent state with some of the ports having newly measured calibration data and others with old data. If this is the case, a dialog box will appear to confirm that you really want to exit. A "Yes" answer will exit the calibration procedure, leaving potentially inconsistent calibration data in place. A "No" answer will return to the calibration procedure.

Marker Function

Some Marker Functions are common across multiple Modes and Measurements. These common features are described in this section. See the Measurement description for information on features that are unique.

The Marker Function key opens up a menu of keys that allow you to control the Marker Functions of the instrument. Marker Functions perform post-processing operations on marker data. Band Functions are Marker Functions that allow you to define a band of frequencies around the marker. The band defines the region of data used for the numerical calculations. These marker functions also allow you to perform mathematical calculations on trace and marker data and report the results of these calculations in place of the normal marker result.

Unlike regular markers, marker function markers are not placed directly on the trace. They are placed at a location which is relative to the result of the function calculation.

Key Path	Front-panel key
Instrument S/W Revision	Prior to A.02.00

Marker Function

Marker

Some Marker operation is common across multiple Modes and Measurements. These common features are described in this section. See the Measurement description for information on features that are unique.

The Marker key accesses the Marker menu. A marker can be placed on a trace to allow the value of the trace at the marker point to be determined precisely. The functions in this menu include a 1-of-N selection of the control mode Normal, Delta, Fixed, or Off for the selected marker. If the selected marker is Off, pressing Marker sets it to Normal and places it at the center of the screen on the trace determined by the Marker Trace rules.

Markers may also be used in pairs to read the difference (or delta) between two data points. They can be used in Marker Functions to do advanced data processing, or to specify operating points in functions like Signal Track and N dB Points.

Key Path	Front-panel key
Instrument S/W Revision	Prior to A.02.00

Marker

Marker To

Some Marker To operation is common across multiple Modes and Measurements. These common features are described in this section. See the Measurement description for information on features that are unique.

Key Path	Front-panel key
Instrument S/W Revision	Prior to A.02.00

Marker To

Measurement Group of Commands

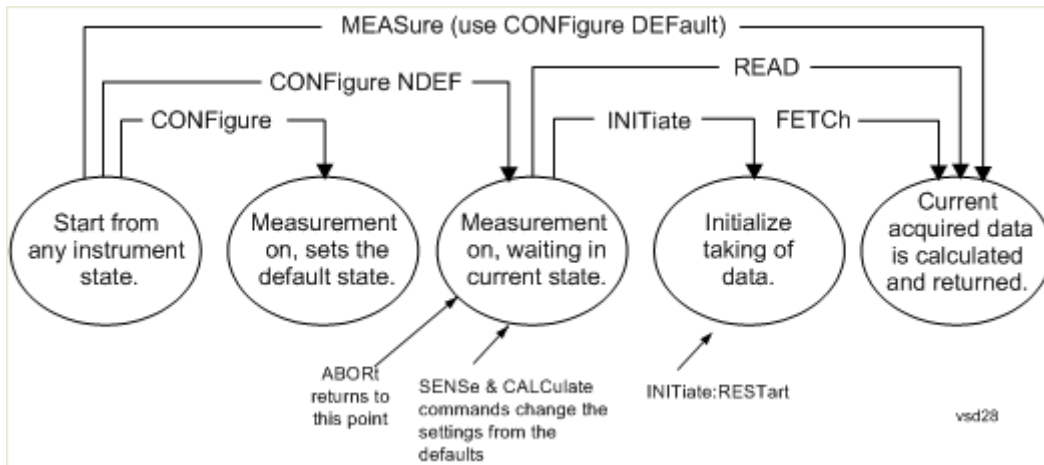

Measure Commands:

:MEASure:<measurement>[n]?

This is a fast single-command way to make a measurement using the factory default instrument settings. These are the settings and units that conform to the Mode Setup settings (e.g. radio standard) that you have currently selected.

- Stops the current measurement (if any) and sets up the instrument for the specified measurement using the factory defaults
- Initiates the data acquisition for the measurement
- Blocks other SCPI communication, waiting until the measurement is complete before returning results.
- If the function does averaging, it is turned on and the number of averages is set to 10.
- After the data is valid it returns the scalar results, or the trace data, for the specified measurement. The type of data returned may be defined by an [n] value that is sent with the command.

The scalar measurement results will be returned if the optional [n] value is not included, or is set to 1. If the [n] value is set to a value other than 1, the selected trace data results will be returned. See each command for details of what types of scalar results or trace data results are available.

ASCII is the default format for the data output. (Older versions of Spectrum Analysis and Phase Noise mode measurements only use ASCII.) The binary data formats should be used for handling large blocks of data since they are smaller and faster than the ASCII format. Refer to the FORMat:DATA command for more information.

If you need to change some of the measurement parameters from the factory default settings you can set up the measurement with the CONFigure command. Use the commands in the SENSE:<measurement> and CALCulate:<measurement> subsystems to change the settings. Then you can use the READ? command to initiate the measurement and query the results.

If you need to repeatedly make a given measurement with settings other than the factory defaults, you can use the commands in the SENSE:<measurement> and CALCulate:<measurement> subsystems to set up the measurement. Then use the READ? command to initiate the measurement and query results.

Measurement settings persist if you initiate a different measurement and then return to a previous one. Use READ:<measurement>? if you want to use those persistent settings. If you want to go back to the default settings, use MEASure:<measurement>?.

Configure Commands:**:CONFigure:<measurement>**

This command stops the current measurement (if any) and sets up the instrument for the specified measurement using the factory default instrument settings. It does not initiate the taking of measurement data unless INIT:CONTinuous is ON. If you change any measurement settings after using the CONFigure command, the READ command can be used to initiate a measurement without changing the settings back to their defaults.

In the Swept SA measurement in Spectrum Analyzer mode the CONFigure command also turns the averaging function on and sets the number of averages to 10 for all measurements.

:CONFigure:NDEFault<measurement> stops the current measurement and changes to the specified measurement. It does not change the settings to the defaults. It does not initiate the taking of measurement data unless INIT:CONTinuous is ON.

The **CONFigure?** query returns the current measurement name.

The **CONFigure:CATalog?** query returns a quoted string of all measurement names in the current mode. For example, "SAN, CHP, OBW, ACP, PST, TXP, SPUR, SEM, LIST".

Fetch Commands:

:FETCh:<measurement>[n]?

This command puts selected data from the most recent measurement into the output buffer. Use FETCh if you have already made a good measurement and you want to return several types of data (different [n] values, for example, both scalars and trace data) from a single measurement. FETCh saves you the time of re-making the measurement. You can only FETCh results from the measurement that is currently active, it will not change to a different measurement. An error is reported if a measurement other than the current one, is specified.

If you need to get new measurement data, use the READ command, which is equivalent to an INITiate followed by a FETCh.

The scalar measurement results will be returned if the optional [n] value is not included, or is set to 1. If the [n] value is set to a value other than 1, the selected trace data results will be returned. See each command for details of what types of scalar results or trace data results are available. The binary data formats should be used for handling large blocks of data since they are smaller and transfer faster than the ASCII format. (FORMat:DATA)

FETCh may be used to return results other than those specified with the original READ or MEASure command that you sent.

INITiate Commands:

:INITiate:<measurement>

This command is not available for measurements in all the instrument modes:

- Initiates a trigger cycle for the specified measurement, but does not output any data. You must then use the FETCh<meas> command to return data. If a measurement other than the current one is specified, the instrument will switch to that measurement and then initiate it.
- For example, suppose you have previously initiated the ACP measurement, but now you are running the channel power measurement. If you send INIT:ACP? it will change from channel power to ACP and will initiate an ACP measurement.
- Does not change any of the measurement settings. For example, if you have previously started the ACP measurement and you send INIT:ACP? it will initiate a new ACP measurement using the same instrument settings as the last time ACP was run.
- If your selected measurement is currently active (in the idle state) it triggers the measurement, assuming the trigger conditions are met. Then it completes one trigger cycle. Depending upon the measurement and the number of averages, there may be multiple data acquisitions, with multiple trigger events, for one full trigger cycle. It also holds off additional commands on GPIB until the acquisition is complete.

READ Commands:

:READ:<measurement>[n]?

- Does not preset the measurement to the factory default settings. For example, if you have previously initiated the ACP measurement and you send READ:ACP? it will initiate a new measurement using the same instrument settings.
- Initiates the measurement and puts valid data into the output buffer. If a measurement other than the current one is specified, the instrument will switch to that measurement before it initiates the measurement and returns results.

For example, suppose you have previously initiated the ACP measurement, but now you are running the channel power measurement. Then you send READ:ACP? It will change from channel power back to ACP and, using the previous ACP settings, will initiate the measurement and return results.

- Blocks other SCPI communication, waiting until the measurement is complete before returning the results

If the optional [n] value is not included, or is set to 1, the scalar measurement results will be returned. If the [n] value is set to a value other than 1, the selected trace data results will be returned. See each command for details of what types of scalar results or trace data results are available. The binary data formats should be used when handling large blocks of data since they are smaller and faster than the ASCII format.
(FORMat:DATA)

Instrument S/W Revision Prior to A.02.00

Current Measurement Query (Remote Command Only)

This command returns the name of the measurement that is currently running.

Remote Command: :CONFigure?

Example: CONF?
 Instrument S/W Revision: Prior to A.02.00

Limit Test Current Results (Remote Command Only)

Queries the status of the current measurement limit testing. It returns a 0 if the measured results pass when compared with the current limits. It returns a 1 if the measured results fail any limit tests.

Remote Command: :CALCulate:CLIMits:FAIL?

Example: CALC:CLIM:FAIL? queries the current measurement to see if it fails the defined limits.

Returns a 0 or 1: 0 it passes, 1 it fails.

Instrument S/W Revision: Prior to A.02.00

Data Query (Remote Command Only)

Returns the designated measurement data for the currently selected measurement and subopcode.

n = any valid subopcode for the current measurement. See the measurement command results table for your current measurement, for information about what data is returned for the subopcodes.

This command uses the data setting specified by the FORMat:BORDER and FORMat:DATA commands and can return real or ASCII data. (See the format command descriptions under Input/Output in the Analyzer Setup section.)

Remote Command: :CALCulate:DATA[n]?

Notes: The return trace depends on the measurement.

In CALCulate:<meas>:DATA[n], n is any valid subopcode for the current measurement. It returns the same data as the FETCh:<measurement>? query where <measurement> is the current measurement.

Instrument S/W Revision: Prior to A.02.00

Calculate/Compress Trace Data Query (Remote Command Only)

Returns compressed data for the currently selected measurement and sub-opcode [n].

n = any valid sub-opcode for that measurement. See the MEASure:<measurement>? command description of your specific measurement for information on the data that can be returned.

The data is returned in the current Y Axis Unit of the analyzer. The command is used with a sub-opcode <n> (default=1) to specify the trace. With trace queries, it is best if the analyzer is not sweeping during the query. Therefore, it is generally advisable to be in Single Sweep, or Update=Off.

This command is used to compress or decimate a long trace to extract and return only the desired data. A typical example would be to acquire N frames of GSM data and return the mean power of the first burst

Meas

in each frame. The command can also be used to identify the best curve fit for the data.

Remote Command: `:CALCulate:DATA<n>:COMPRESS?
BLOCK|CFIT|MAXimum|MINimum|MEAN|DMEan|RMS|RMSCubed|SAMPLE
|SDEVIation|PPHase
[,<soffset>[,<length>[,<roffset>[,<rlimit>]]]]`

Remote Command Notes: The command supports 5 parameters. Note that the last 4 (<soffset>, <length>, <roffset>, <rlimit>) are optional. But these optional parameters must be entered in the specified order. For example, if you want to specify <length>, then you must also specify <soffset>. See details below for a definition of each of these parameters.

This command uses the data in the format specified by `FORMAT:DATA`, returning either binary or ASCII data.

Example: To query the mean power of a set of GSM bursts:
Supply a signal that is a set of GSM bursts.
Select the IQ Waveform measurement (in IQ Analyzer Mode).
Set the sweep time to acquire at least one burst.
Set the triggers such that acquisition happens at a known position relative to a burst.
Then query the mean burst levels using, `CALC:DATA2:COMP?
MEAN,24e-6,526e-6` (These parameter values correspond to GSM signals, where 526e-6 is the length of the burst in the slot and you just want 1 burst.)

Instrument S/W Revision: Prior to A.02.00

- **BLOCK** or block data - returns all the data points from the region of the trace data that you specify. For example, it could be used to return the data points of an input signal over several timeslots, excluding the portions of the trace data that you do not want. (This is x,y pairs for trace data and I,Q pairs for complex data.)
- **CFIT** or curve fit - applies curve fitting routines to the data. <soffset> and <length> are required to define the data that you want. <roffset> is an optional parameter for the desired order of the curve equation. The query will return the following values: the x-offset (in seconds) and the curve coefficients ((order + 1) values).

MIN, **MAX**, **MEAN**, **DME**, **RMS**, **RMSC**, **SAMP**, **SDEV** and **PPH** return one data value for each specified region (or <length>) of trace data, for as many regions as possible until you run out of trace data (using <roffset> to specify regions). Or they return the number of regions you specify (using <rlimit>) ignoring any data beyond that.

- **MINimum** - returns the minimum data point (x,y pair) for the specified region(s) of trace data. For I/Q trace data, the minimum magnitude of the I/Q pairs is returned.
- **MAXimum** - returns the maximum data point (x,y pair) for the specified region(s) of trace data. For I/Q trace data, the maximum magnitude of the I/Q pairs is returned.

MEAN - returns a single value that is the arithmetic mean of the data point values (in dB/ dBm) for the specified region(s) of trace data. For I/Q trace data, the mean of the magnitudes of the I/Q pairs is

returned. See the following equations.

NOTE If the original trace data is in dB, this function returns the arithmetic mean of those log values, not log of the mean power which is a more useful value. The mean of the log is the better measurement technique when measuring CW signals in the presence of noise. The mean of the power, expressed in dB, is useful in power measurements such as Channel Power. To achieve the mean of the power, use the RMS option.

Equation 1
Mean Value of Data Points for Specified Region(s)

$$\text{MEAN} = \frac{1}{n} \sum_{X_i \in \text{region}(s)} X_i \quad \text{vsd27-1}$$

where X_i is a data point value, and n is the number of data points in the specified region(s).

Equation 2
Mean Value of I/Q Data Pairs for Specified Region(s)

$$\text{MEAN} = \frac{1}{n} \sum_{X_i \in \text{region}(s)} |X_i| \quad \text{vsd27-2}$$

where $|X_i|$ is the magnitude of an I/Q pair, and n is the number of I/Q pairs in the specified region(s).

- DMEan - returns a single value that is the mean power (in dB/ dBm) of the data point values for the specified region(s) of trace data. See the following equation:

Equation 3
DMEan Value of Data Points for Specified Region(s)

$$\text{DME} = 10 \times \log_{10} \left(\frac{1}{n} \sum_{X_i \in \text{region}(s)} \frac{X_i}{10} \right) \quad \text{vsd27-3}$$

- RMS - returns a single value that is the average power on a root-mean-squared voltage scale (arithmetic rms) of the data point values for the specified region(s) of trace data. See the following equation.

For I/Q trace data, the rms of the magnitudes of the I/Q pairs is returned. See the following equation.

NOTE This function is very useful for I/Q trace data. However, if the original trace data is

in dB, this function returns the rms of the log values which is not usually needed.

Equation 4**RMS Value of Data Points for Specified Region(s)**

$$\text{RMS} = \sqrt{\frac{1}{n} \sum_{X_i \in \text{region}(s)} X_i^2} \quad \text{vsd27-4}$$

where X_i is a data point value, and n is the number of data points in the specified region(s).

Equation 5**RMS Value of I/Q Data Pairs for Specified Region(s)**

$$\text{RMS} = \sqrt{\frac{1}{n} \sum_{X_i \in \text{region}(s)} X_i X_i^*} \quad \text{vsd27-5}$$

where X_i is the complex value representation of an I/Q pair, X_i^* its conjugate complex number, and n is the number of I/Q pairs in the specified region(s).

Once you have the rms value for a region of trace data (linear or I/Q), you may want to calculate the mean power. You must convert this rms value (peak volts) to power in dBm:

$$10 \times \log[10 \times (\text{rms value})^2]$$

- **SAMPLE** - returns the first data value (x,y pair) for the specified region(s) of trace data. For I/Q trace data, the first I/Q pair is returned.
- **SDEViation** - returns a single value that is the arithmetic standard deviation for the data point values for the specified region(s) of trace data. See the following equation.

For I/Q trace data, the standard deviation of the magnitudes of the I/Q pairs is returned. See the following equation.

Equation 6**Standard Deviation of Data Point Values for Specified Region(s)**

$$\text{SDEV} = \sqrt{\frac{1}{n} \sum_{X_i \in \text{region}(s)} (X_i - \bar{X})^2} \quad \text{vsd27-7}$$

where X_i is a data point value, \bar{X} is the arithmetic mean of the data point values for the specified region(s), and n is the number of data points in the specified region(s).

$$\text{SDEV} = \sqrt{\frac{1}{n} \sum_{X_i \in \text{region}(s)} (|X_i| - \bar{X})^2} \quad \text{vsd27-8}$$

where $|X_i|$ is the magnitude of an I/Q pair, X is the mean of the magnitudes for the specified region(s), and n is the number of data points in the specified region(s).

- PPHase - returns the x,y pairs of both rms power (dBm) and arithmetic mean phase (radian) for every specified region and frequency offset (Hz). The number of pairs is defined by the specified number of regions. This parameter can be used for I/Q vector (n=0) in Waveform (time domain) measurement and all parameters are specified by data point in PPHase.

The rms power of the specified region may be expressed as:

$$\text{Power} = 10 \times \log [10 \times (\text{RMS I/Q value})] + 10.$$

The RMS I/Q value (peak volts) is:

$$\sqrt{\frac{1}{n} \sum_{X_i \in \text{region}} X_i X_i^*}$$

vsd27-9

where X_i is the complex value representation of an I/Q pair, X_i^* its conjugate complex number, and n is the number of I/Q pairs in the specified region.

The arithmetic mean phase of the specified region may be expressed as:

$$\frac{1}{n} \sum_{Y_i \in \text{region}} Y_i$$

vsd27-10

where Y_i is the unwrapped phase of I/Q pair with applying frequency correction and n is the number of I/Q pairs in the specified region.

The frequency correction is made by the frequency offset calculated by the arithmetic mean of every specified region's frequency offset. Each frequency offset is calculated by the least square method against the unwrapped phase of I/Q pair.

Sample Trace Data - Constant Envelope

(See below for explanation of variables.)

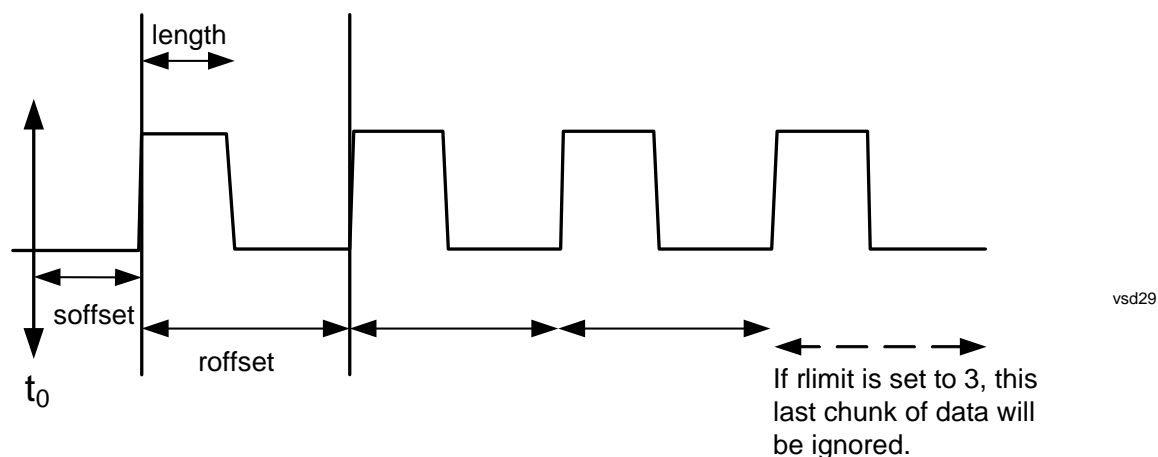

Sample Trace Data - Not Constant Envelope

(See below for explanation of variables.)

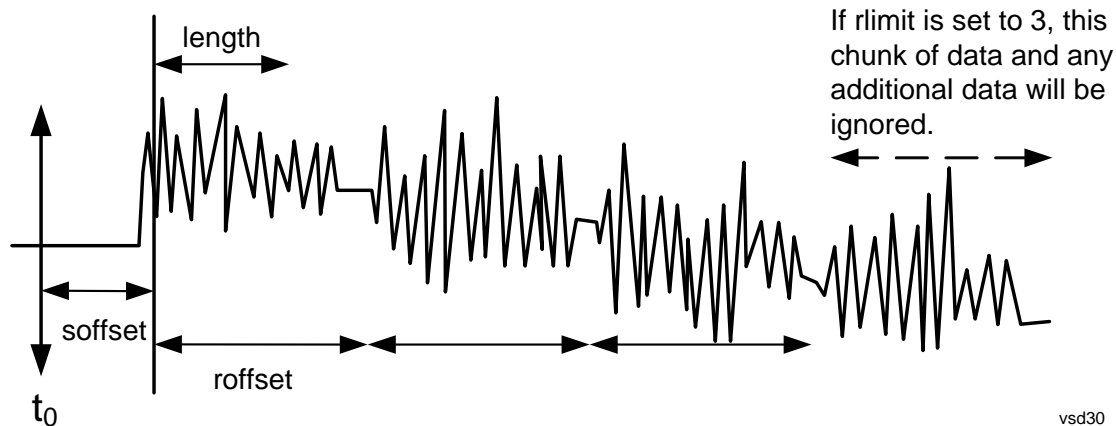

<offset> - start offset is an optional real number. (It is in seconds for time-domain traces, and is a dimensionless index 0 to Npoints - 1, for frequency-domain traces). It specifies the amount of data at the beginning of the trace that will be ignored before the decimation process starts. It is the time or frequency change from the start of the trace to the point where you want to start using the data. The default value is zero.

<length> - is an optional real number. (It is in seconds for time-domain traces, and is a dimensionless index 0 to Npoints - 1, for frequency-domain traces). It defines how much data will be compressed into one value. This parameter has a default value equal to the current trace length.

<roffset> - repeat offset is an optional real number. (It is in seconds for time-domain traces, and is a dimensionless index 0 to Npoints - 1, for frequency-domain traces). It defines the beginning of the next field of trace elements to be compressed. This is relative to the beginning of the previous field. This parameter has a default value equal to the <length> variable. Note that this parameter is used for a completely different purpose when curve fitting (see CFIT above).

<rlimit> - repeat limit is an optional integer. It specifies the number of data items that you want returned. It will ignore any additional items beyond that number. You can use the Start offset and the Repeat limit to pick out exactly what part of the data you want to use. The default value is all the data.

Calculate Peaks of Trace Data (Remote Command Only)

Returns a list of all the peaks for the currently selected measurement and sub-opcode [n]. The peaks must meet the requirements of the peak threshold and excursion values.

n = any valid sub-opcode for the current measurement. See the MEASure:<measurement> command description of your specific measurement for information on the data that can be returned.

The command can only be used with specific sub-opcodes with measurement results that are trace data. Both real and complex traces can be searched, but complex traces are converted to magnitude in dBm. In many measurements the sub-opcode n=0, is the raw trace data which cannot be searched for peaks. And Sub-opcode n=1, is often calculated results values which also cannot be searched for peaks.

This command uses the data setting specified by the FORMat:BORDER and FORMat:DATA commands and can return real or ASCII data. If the format is set to INT,32, it returns REAL,32 data.

The command has four types of parameters:

- Threshold (in dBm)
- Excursion (in dB)
- Sorting order (amplitude, frequency, time)
- Optional in some measurements: Display line use (all, > display line, < display line)

Remote Command:

For Swept SA measurement:

```
:CALCulate:DATA[1] | 2 | 3 | 4 | 5 | 6 : PEAKs?
<threshold>, <excursion>[ , AMPLitude | FREQuency | TIME[ , ALL |
GTDLine | LTDLine ]]
```

For most other measurements:

```
:CALCulate:DATA[1] | 2 | 3 | 4 | 5 | 6 : PEAKs?
<threshold>, <excursion>[ , AMPLitude | FREQuency | TIME]
```

Example:

Example for Swept SA measurement in Spectrum Analyzer Mode:

CALC:DATA4:PEAK? -40,10,FREQ,GTDL This will identify the peaks of trace 4 that are above -40 dBm, with excursions of at least 10 dB. The peaks are returned in order of increasing frequency, starting with the lowest frequency. Only the peaks that are above the display line are returned.

Query Results 1:

With FORMat:DATA REAL,32 selected, it returns a list of floating-point numbers. The first value in the list is the number of peak points that are in the following list. A peak point consists of two values: a peak amplitude followed by its corresponding frequency (or time).

If no peaks are found the peak list will consist of only the number of peaks, (0).

Dependencies/Couplings:

Values must be provided for threshold and excursion. The sorting and display line parameters are optional (defaults are AMPLitude and ALL).

Note that there is always a Y-axis value for the display line, regardless of whether the display line state is on or off. It is the current Y-axis value of the display line which is used by this command to determine whether a peak should be reported.

Meas

Notes:

<n> - is the trace that will be used

<threshold> - is the level below which trace data peaks are ignored. Note that the threshold value is required and is always used as a peak criterion. To effectively disable the threshold criterion for this command, provide a substantially low threshold value such as -200 dBm. Also note that the threshold value used in this command is independent of and has no effect on the threshold value stored under the Peak Criteria menu.

<excursion> - is the minimum amplitude variation (rise and fall) required for a signal to be identified as peak. Note that the excursion value is required and is always used as a peak criterion. To effectively disable the excursion criterion for this command, provide the minimum value of 0.0 dB. Also note that the excursion value used in this command is independent of and has no effect on the excursion value stored under the Peak Criteria menu.

Sorting order:

AMPLitude - lists the peaks in order of descending amplitude, with the highest peak first (default if optional parameter not sent)

FREQuency - lists the peaks in order of occurrence, left to right across the x-axis.

TIME - lists the peaks in order of occurrence, left to right across the x-axis.

Peaks vs. Display Line:

ALL - lists all of the peaks found (default if optional parameter not sent).

GTDLIne (greater than display line) - lists all of the peaks found above the display line.

LTDLine (less than display line) - lists all of the peaks found below the display line.

Instrument S/W Revision: Prior to A.02.00

Format Data: Numeric Data (Remote Command Only)

This command specifies the format of the trace data input and output. It specifies the formats used for trace data during data transfer across any remote port. It affects only the data format for setting and querying trace data for the :TRACe[:DATA], TRACe[:DATA]?, :CALCulate:DATA[n]? and FETCh:SANalyzer[n]? commands and queries.

Remote Command: :FORMat[:TRACe][[:DATA] ASCii|INTeger,32|REAL,32 |REAL,64
:FORMat[:TRACe][[:DATA]?]

Remote Command Notes:	<p>The query response is:</p> <p>ASCIi: ASC,8</p> <p>REAL,32: REAL,32</p> <p>REAL,64: REAL,64</p> <p>INTeger,32: INT,32</p> <p>When the numeric data format is REAL or ASCII, data is output in the current Y Axis unit. When the data format is INTeger, data is output in units of m dBm (.001 dBm).</p> <p>Note that the INT,32 format is only applicable to the command, TRACe:DATA. This preserves backwards compatibility for the Swept SA measurement. For all other commands/queries which honor FORMat:DATA, if INT,32 is sent the analyzer will behave as though it were set to REAL,32.</p> <p>The INT,32 format returns binary 32-bit integer values in internal units (m dBm), in a definite length block.</p>
Dependencies/Couplings:	<p>Sending a data format spec with an invalid number (for example, INT,48) generates no error. The analyzer simply uses the default (8 for ASCII, 32 for INTeger, 32 for REAL).</p> <p>Sending data to the analyzer which does not conform to the current FORMat specified, results in an error.</p>
Preset:	ASCIi
Instrument S/W Revision:	Prior to A.02.00

The specs for each output type follow:

ASCIi - Amplitude values are in ASCII, in the current Y Axis Unit, one ASCII character per digit, values separated by commas, each value in the form:

SX.YYYYYYEsZZ

Where:

S = sign (+ or -)

X = one digit to left of decimal point

Y = 5 digits to right of decimal point

E = E, exponent header

s = sign of exponent (+ or -)

ZZ = two digit exponent

REAL,32 - Binary 32-bit real values in the current Y Axis Unit, in a definite length block.

REAL,64 - Binary 64-bit real values in the current Y Axis Unit, in a definite length block.

Format Data: Byte Order (Remote Command Only)

This command selects the binary data byte order for data transfer and other queries. It controls whether binary data is transferred in normal or swapped mode. This command affects only the byte order for setting and querying trace data for the :TRACe[:DATA], TRACe[:DATA]?, :CALCulate:DATA[n]? and FETCh:SANalyzer[n]? commands and queries.

By definition any command that says it uses FORMat:DATA uses any format supported by FORMat:DATA.

The NORMal order is a byte sequence that begins with the most significant byte (MSB) first, and ends with the least significant byte (LSB) last in the sequence: 1|2|3|4. SWAPped order is when the byte sequence begins with the LSB first, and ends with the MSB last in the sequence: 4|3|2|1.

Remote Command: :FORMat:BORDER NORMAL|SWAPped
:FORMat:BORDER?
Preset: NORMal
Instrument S/W Revision: Prior to A.02.00

Meas Setup

Meas Control features are unique to each Measurement. See the specific Measurement for more information.

Key Path	Front-panel key
Instrument S/W Revision	Prior to A.02.00

Meas Setup

Mode

The Mode key allows you to select the available measurement applications. The application software must be licensed in order for it to be available. Measurement applications are a collection of measurement capabilities packaged together to provide an instrument personality that is specific to your measurement needs. Each application software product is ordered separately by Model Number.

NOTE Key operation can be different between modes. The information displayed in Help is about the current mode.

To access Help for a different Mode you must first exit Help (by pressing the Cancel (Esc) key). Then select the desired mode and re-access Help.

Once an instrument mode is selected, only the commands that are valid for that mode can be executed. A list of the valid mode choices is returned with the INST:CAT? Query.

It is possible to specify the order in which the Modes appear in the Mode menu, using the Configure Applications utility (**System, Power On, Configure Applications**). It is also possible, using the same utility, to specify a subset of the available applications to load at startup time, which can significantly decrease the startup time of the analyzer. If this is done, then during runtime, if an application which is not loaded into memory is selected by you using the Mode menu or by sending SCPI commands, there will be a significant pause while the Application is loaded. During this pause a message box which says “Loading application ...” is displayed.

Remote Command	:INSTrument [:SElect] SA BASIC ADEMOD NFIGURE PNOISE CDMA2K TDSCDMA VSA VSA89 601 WCDMA WIMAXOFDMA EDGE GSM CDMA1XEV RLC :INSTrument [:SElect]?
Example	:INST SA
Remote Command Notes	The available parameters are dependent upon installed and licensed applications resident in the instrument. Parameters given here are an example, specific parameters are in the individual Application. Once an instrument mode is selected, only the commands that are valid for that mode can be executed.
Key Path	Front-panel key
Preset	Not affected by Preset. Set to SA following Restore System Defaults, if SA is the default mode.
State Saved	Saved in state
Instrument S/W Revision	Prior to A.02.00

Mode

Application Mode Number Selection (Remote Command only)

Select the measurement mode by its mode number. The actual available choices depend upon which applications are installed in your instrument. The modes appear in this table by NSEL number, which is not the same as their order in the Mode menu (see “Detailed List of Modes” on page 1150 for the mode order).

Mode	:INSTrument:NSElect <integer>	:INSTrument[:SElect] <parameter>
Spectrum Analyzer	1	SA
I/Q Analyzer (Basic)	8	BASIC
WCDMA with HSDPA/HSUPA	9	WCDMA
cdma2000	10	CDMA2K
GSM/EDGE/EDGE Evo	13	EDGE GSM
Phase Noise	14	PNOISE
1xEV-DO	15	CDMA1XEV
Combined WLAN	19	CWLAN
802.16 OFDMA (WiMAX/WiBro)	75	WIMAXOFDMA
Combined Fixed WiMAX	81	CWIMAXOFDM
Vector Signal Analyzer (VXA)	100	VSA
89601 VSA	101	VSA89601
LTE	102	LTE
iDEN/WiDEN/MotoTalk	103	IDEN
802.16 OFDM (Fixed WiMAX)	104	WIMAXFIXED
TD-SCDMA with HSPA/8PSK	211	TDSCDMA
Noise Figure	219	NFIGURE
Analog Demod	234	ADEMODO
DVB-T/H	235	DVB
DTMB	236	DTMB
Remote Language Compatibility	266	RLC

Remote Command: :INSTrument:NSElect <integer>
:INSTrument:NSElect?

Example: :INST:NSEL 1

Remote Command Notes:	SA mode is 1 The command must be sequential: i.e. continued parsing of commands cannot proceed until the instrument select is complete and the resultant SCPI trees are available.
Preset:	Not affected by Preset. Set to default mode (1 for SA mode) following Restore System Defaults.
State Saved:	Saved in state
Instrument S/W Revision:	Prior to A.02.00

Application Mode Catalog Query (Remote Command only)

Returns a string containing a comma separated list of names of all the installed and licensed measurement modes (applications). These names can only be used with the :INSTRument[:SElect] command.

Remote Command:	:INSTRument:CATalog?
Example:	:INST:CAT?
Remote Command Notes:	Query returns a quoted string of the installed and licensed modes separated with a comma. Example: "SA,PNOISE,WCDMA"
Instrument S/W Revision:	Prior to A.02.00

Application Identification (Remote Commands only)

Each entry in the Mode Menu will have a Model Number and associated information: Version, and Options.

This information is displayed in the Show System screen. The corresponding SCPI remote commands are defined here.

Current Application Model

Returns a string which is the Model Number of the currently selected application (mode).

Remote Command:	:SYSTem:APPLication[:CURRent][:NAME]?
Example:	:SYST:APPL?
Remote Command Notes:	Query returns a quoted string which is the Model Number of the currently selected application (Mode). Example: "N9060A" String length is 6 characters.
Preset:	Not affected by Preset

Mode

State Saved: Not saved in state, the value will be the selected application when Save is done.

Instrument S/W Revision: Prior to A.02.00

Current Application Revision

Returns a string which is the Revision of the currently selected application (mode).

Remote Command: :SYSTem:APPLication[:CURRent]:REVision?

Example: :SYST:APPL:REV?

Remote Command Notes: Query returns a quoted string which is the Revision of the currently selected application (Mode). Example:

"1.0.0.0"

String length is a maximum of 23 characters. (each numeral can be an integer + 3 decimal points)

Preset: Not affected by Preset

State Saved: Not saved in state, the value will be the selected application when Save is done.

Instrument S/W Revision: Prior to A.02.00

Current Application Options

Returns a string which is the Options list of the currently selected application (mode).

Remote Command: :SYSTem:APPLication[:CURRent]:OPTion?

Remote Command Notes: Query returns a quoted string which is the Option list of the currently selected application (Mode). The format is the name as the *OPT? or SYSTem:OPTion command: a comma separated list of option identifiers. Example:

"1FP,2FP"

String length is a maximum of 255 characters.

Preset: Not affected by Preset

State Saved: Not saved in state per se, value will be the selected application when Save is invoked

Example: :SYST:APPL:OPT?

Instrument S/W Revision: Prior to A.02.00

Application Identification Catalog (Remote Commands only)

A catalog of the installed and licensed applications (Modes) can be queried for their identification.

Application Catalog number of entries

Returns the number of installed and licensed applications (Modes).

Remote Command: :SYSTem:APPLication:CATalog[:NAME]:COUNT?

Example: :SYST:APPL:CAT:COUN?

Preset: Not affected by Preset

State Saved: Not saved in state.

Instrument S/W Revision: Prior to A.02.00

Application Catalog Model Numbers

Returns a list of Model Numbers for the installed and licensed applications (Modes).

Remote Command: :SYSTem:APPLication:CATalog[:NAME]?

Example: :SYST:APPL:CAT?

Remote Command Notes: Returned value is a quoted string of a comma separated list of Model Numbers. Example, if SAMS and Phase Noise are installed and licensed:

"N9060A,N9068A"

String length is COUNT * 7 - 1. (7 = Model Number length + 1 for comma. -1 = no comma for the 1st entry.)

Preset: Not affected by Preset

State Saved: Not saved in state.

Instrument S/W Revision: Prior to A.02.00

Application Catalog Revision

Returns the Revision of the provided Model Number.

Remote Command: :SYSTem:APPLication:CATalog:REVision? <model>

Example: :SYST:APPL:CAT:REV? 'N9060A'

Remote Command Notes: Returned value is a quoted string of revision for the provided Model Number. The revision will be a null-string ("") if the provided Model Number is not installed and licensed. Example, if SAMS is installed and licensed:

"1.0.0.0"

Mode

Preset:	Not affected by Preset
State Saved:	Not saved in state.
Instrument S/W Revision:	Prior to A.02.00

Application Catalog Options

Returns a list of Options for the provided Model Number

Remote Command:	:SYSTem:APPLication:CATalog:OPTion? <model>
Example:	:SYST:APPL:CAT:OPT? 'N9060A'
Remote Command Notes:	Returned value is a quoted string of a comma separated list of Options, in the same format as *OPT? or :SYSTem:OPTion?. If the provided Model Number is not installed and licensed a null-string ("") will be returned. Example, if SAMS is installed and licensed: "2FP" String length is a maximum of 255 characters.
Preset:	Not affected by Preset
State Saved:	Not saved in state.
Instrument S/W Revision:	Prior to A.02.00

Detailed List of Modes

Spectrum Analyzer

Selects the Spectrum Analyzer mode for general purpose measurements. There are several measurements available in this mode. General spectrum analysis measurements, in swept and zero span, can be done using the first key in the Meas menu, labeled Swept SA. Other measurements in the Meas Menu are designed to perform specialized measurement tasks, including power and demod measurements.

If you are using the Help feature, this mode must be currently active to access its detailed information. If it is not active, exit the Help feature (Esc key), select the mode, and re-access Help.

Example	INST:SEL SA INST:NSEL 1
Key Path	Mode
Instrument S/W Revision	Prior to A.02.00

IQ Analyzer (Basic)

The IQ Analyzer Mode makes general purpose frequency domain and time domain measurements. These measurements often use alternate hardware signal paths when compared with a similar measurement in the Signal Analysis Mode using the Swept SA measurement. These frequency domain and time domain

measurements can be used to output I/Q data results when measuring complex modulated digital signals. If you are using the Help feature, this mode must be currently active to access its detailed information. If it is not active, exit the Help feature (Esc key), select the mode, and re-access Help.

Example	INST:SEL BASIC INST:NSEL 8
Key Path	Mode
Instrument S/W Revision	Prior to A.02.00

W-CDMA with HSDPA/HSUPA

Selects the W-CDMA with HSDPA/HSUPA mode for general purpose measurements of signals following this standard. There are several measurements available in this mode.

If you are using the Help feature, this mode must be currently active to access its detailed information. If it is not active, exit the Help feature (Esc key), select the mode, and re-access Help.

Example	INST:SEL WCDMA INST:NSEL 9
Key Path	Mode
Instrument S/W Revision	Prior to A.02.00

GSM/EDGE/EDGE Evo

Selects the GSM with EDGE mode for general purpose measurements of signals following this standard. There are several measurements available in this mode.

If you are using the Help feature, this mode must be currently active to access its detailed information. If it is not active, exit the Help feature (Esc key), select the mode, and re-access Help.

Example	INST:SEL EDGEGSM INST:NSEL 13
Key Path	Mode
Instrument S/W Revision	Prior to A.02.00
Modified at S/W Revision	A.02.00

802.16 OFDMA (WiMAX/WiBro)

Selects the OFDMA mode for general purpose measurements of WiMAX signals. There are several measurements available in this mode.

If you are using the Help feature, this mode must be currently active to access its detailed information. If

Mode

it is not active, exit the Help feature (Esc key), select the mode, and re-access Help.

Example	INST:SEL WIMAXOFDMA INST:NSEL 75
Key Path	Mode
Instrument S/W Revision	Prior to A.02.00

Vector Signal Analyzer (VXA)

The 89601X Vector Signal Analyzer provides vector-signal analysis measurement capability. It provides 3 main measurements that allow you to measure the signal quality of all varieties of RF modulation:

- Digital Demodulation
- Analog Demodulation
- Vector Signal Analysis

There are advanced modulation analysis and troubleshooting capabilities including the following communications formats: AM, FM, PM, WiMAX, W-CDMA, 2G, 3G, 3.5G, WLAN, digital video, and more. It also provides standard-specific measurements for analysis of iDEN, WiDEN, and MotoTalk signals with Option H09.

If you are using the Help feature, this mode must be currently active to access its detailed information. If it is not active, exit the Help feature (Esc key), select the mode, and re-access Help.

Example	INST:SEL VSA INST:NSEL 100
Key Path	Mode
Instrument S/W Revision	Prior to A.02.00

Phase Noise

The Phase Noise mode provides pre-configured measurements for making general purpose measurements of device phase noise.

If you are using the Help feature, this mode must be currently active to access its detailed information. If it is not active, exit the Help feature (Esc key), select the mode, and re-access Help.

Example	INST:SEL PNOISE or INST:NSEL 14
Key Path	Mode
Instrument S/W Revision	Prior to A.02.00

Noise Figure

The Noise Figure mode provides pre-configured measurements for making general purpose measurements of device noise figure.

If you are using the Help feature, this mode must be currently active to access its detailed information. If it is not active, exit the Help feature (Esc key), select the mode, and re-access Help.

Example	INST:SEL NFIGURE Or INST:NSEL 219
Key Path	Mode
Instrument S/W Revision	Prior to A.02.00

Analog Demod

Selects the Analog Demod mode for making measurements of AM, FM and phase modulated signals.

If you are using the Help feature, this mode must be currently active to access its detailed information. If it is not active, exit the Help feature (Esc key), select the mode, and re-access Help.

Example	INST:SEL ADEMOM INST:NSEL 234
Key Path	Mode
Instrument S/W Revision	Prior to A.02.00

TD-SCDMA with HSPA/8PSK

Selects the TD-SCDMA mode for general purpose measurements of signals following this standard. There are several measurements available in this mode.

If you are using the Help feature, this mode must be currently active to access its detailed information. If it is not active, exit the Help feature (Esc key), select the mode, and re-access Help.

Example	INST:SEL TDSCDMA INST:NSEL 211
Key Path	Mode
Instrument S/W Revision	Prior to A.02.00

cdma2000

Selects the cdma2000 mode for general purpose measurements of signals following this standard. There are several measurements available in this mode.

If you are using the Help feature, this mode must be currently active to access its detailed information. If

Mode

it is not active, exit the Help feature (Esc key), select the mode, and re-access Help.

Example	INST:SEL CDMA2K INST:NSEL 10
Key Path	Mode
Instrument S/W Revision	Prior to A.02.00

1xEV-DO

Selects the 1xEV-DO mode for general purpose measurements of signals following this standard. There are several measurements available in this mode.

If you are using the Help feature, this mode must be currently active to access its detailed information. If it is not active, exit the Help feature (Esc key), select the mode, and re-access Help.

Example	INST:SEL CDMA1XEV INST:NSEL 15
Key Path	Mode
Instrument S/W Revision	Prior to A.02.00

LTE

Selects the LTE mode for general purpose measurements of signals following this standard. There are several measurements available in this mode.

If you are using the Help feature, this mode must be currently active to access its detailed information. If it is not active, exit the Help feature (Esc key), select the mode, and re-access Help.

Example	INST:SEL LTE INST:NSEL 102
Key Path	Mode
Instrument S/W Revision	Prior to A.02.00

DVB-T/H

Selects the DVB-T/H mode for measurements of digital video signals using this format. There are several power and demod measurements available in this mode.

If you are using the Help feature, this mode must be currently active to access its detailed information. If it is not active, exit the Help feature (Esc key), select the mode, and re-access Help.

Example	INST:SEL DVB INST:NSEL 235
Key Path	Mode

Instrument S/W Revision A.02.00

DTMB

Selects the DTMB mode for measurements of digital video signals using this format. There are several power and demod measurements available in this mode.

If you are using the Help feature, this mode must be currently active to access its detailed information. If it is not active, exit the Help feature (Esc key), select the mode, and re-access Help.

Example INST:SEL DTMB

INST:NSEL 236

Key Path **Mode**

Instrument S/W Revision A.02.00

Combined WLAN

Selects the CWLAN mode for general purpose measurements of signals following this standard. There are several measurements available in this mode.

If you are using the Help feature, this mode must be currently active to access its detailed information. If it is not active, exit the Help feature (Esc key), select the mode, and re-access Help.

Example INST:SEL CWLAN

INST:NSEL 19

Key Path **Mode**

Instrument S/W Revision A.02.00

Combined Fixed WiMAX

Selects the Combined Fixed WiMAX mode for general purpose measurements of signals following this standard. There are several measurements available in this mode.

If you are using the Help feature, this mode must be currently active to access its detailed information. If it is not active, exit the Help feature (Esc key), select the mode, and re-access Help.

Example INST:SEL CWIMAXOFDM

INST:NSEL 81

Key Path **Mode**

Instrument S/W Revision A.02.00

802.16 OFDM (Fixed WiMAX)

Selects the 802.16 OFDM (Fixed WiMAX) mode. This mode allows modulation quality measurements of signals that comply with IEEE 802.16a–2003 and IEEE 802.16–2004 standards, with flexibility to measure nonstandard OFDM formats. Along with the typical digital demodulation measurement results,

Mode

several additional 802.16 OFDM unique trace data formats and numeric error data results provide enhanced data analysis.

If you are using the Help feature, this mode must be currently active to access its detailed information. If it is not active, exit the Help feature (Esc key), select the mode, and re-access Help.

Key Path	Mode
Example	INST:SEL WIMAXFIXED INST:NSEL 104
Instrument S/W Revision	A.02.00

iDEN/WiDEN/MOTOTalk

Selects the iDEN/WiDEN/MOTOTalk mode for general purpose measurements of iDEN and iDEN-related signals. There are several measurements available in this mode.

If you are using the Help feature, this mode must be currently active to access its detailed information. If it is not active, exit the Help feature (Esc key), select the mode, and re-access Help.

Example	INST:SEL IDEN INST:NSEL 103
Key Path	Mode
Instrument S/W Revision	A.02.00

Remote Language Compatibility

The Remote Language Compatibility (RLC) mode provides remote command backwards compatibility for the 8560 series of spectrum analyzers, known as legacy spectrum analyzers.

NOTE After changing into or out of RLC mode, allow a 1 second delay before sending any subsequent commands.

If you are using the Help feature, this mode must be currently active to access its detailed information. If it is not active, exit the Help feature (Esc key), select the mode, and re-access Help.

Example	INST:SEL RLC Or INST:NSEL 266
Key Path	Mode
Instrument S/W Revision	Prior to A.02.00

89601 VSA

Selecting the 89601 VSA mode will start the 89600-Series VSA software application. The 89600 VSA

software is powerful, PC-based software, offering the industry's most sophisticated general purpose and standards specific signal evaluation and troubleshooting tools for the R&D engineer. Reach deeper into signals, gather more data on signal problems, and gain greater insight.

- Over 30 general-purpose analog and digital demodulators ranging from 2FSK to 1024QAM
- Standards specific modulation analysis including:
 - Cell: GSM, cdma2000, WCDMA, TD-SCDMA and more
 - Wireless networking: 802.11a/b/g, 802.11n, 802.16 WiMAX (fixed/mobile), UWB
 - RFID
 - Digital satellite video and other satellite signals, radar, LMDS
- Up to 400K bin FFT, for the highest resolution spectrum analysis
- A full suite of time domain analysis tools, including signal capture and playback, time gating, and CCDF measurements
- Six simultaneous trace displays and the industry's most complete set of marker functions
- Easy-to-use Microsoft ® Windows ® graphical user interface

For more information see the Agilent 89600 Series VSA web site at www.agilent.com/find/89600

To learn more about how to use the 89600 VSA running in the MXA, after the 89600 VSA application is running, open the 89600 VSA Help and open the "About Agilent X-Series Signal Analyzers (MXA/EXA) with 89600-Series Software" help topic.

Example	INST:SEL VSA89601 INST:NSEL 101
Key Path	Mode
Instrument S/W Revision	Prior to A.02.00

Mode

Mode Setup

Sub-frame, is used for analysis and trace data measurement results. The available selections include timeslots 0 through 6, the DwPTS and the UpPTS timeslots.

Mode	TD-SCDMA
Remote Command	[:SENSe] :SLOT TS0 TS1 TS2 TS3 TS4 TS5 TS6 UPTS DPTS [:SENSe] :SLOT?
Example	:SLOT TS0 :SLOT?
Dependencies/Couplings	For all the measurements which adopt the gate sweep, the parameters Gate Delay and Gate Length are coupled with the Analysis Timeslot and the Gate Source. When changing the Analysis Timeslot or the Gate Source, the Gate Delay and Gate Length will be coupled according to Table 17-3 on page 1160 .
Preset	TS0
State Saved	Saved in instrument state.
Range	TS0 TS1 TS2 TS3 TS4 TS5 TS6 DwPTS UpPTS
Key Path	Mode Setup

Table 17-3 Gate Source = EXternal[1] or EXternal[2]

Timeslot	Gate Delay (μ s)	Gate Length (μ s)
TS0	0.0 + time offset ^a	662.5 ^b
DwPTS	700.0 + time offset ^a	50.0 ^b
UpPTS	825.0 + time offset ^a	100.0 ^b
TS1	950.0 + time offset ^a	662.5 ^b
TS2	1625.0 + time offset ^a	662.5 ^b
TS3	2300.0 + time offset ^a	662.5 ^b
TS4	2975.0 + time offset ^a	662.5 ^b
TS5	3650.0 + time offset ^a	662.5 ^b
TS6	4325.0 + time offset ^a	662.5 ^b

Table 17-4 Gate Source = RFBurst

Timeslot	Gate Delay (μ s)	Gate Length (μ s)
TS0	0.0 + time offset ^a	662.5 ^b
DwPTS	700.0 + time offset ^a	50.0 ^b

Table 17-4 Gate Source = RFBurst

Timeslot	Gate Delay (μ s)	Gate Length (μ s)
UpPTS	825.0 + time offset ^a	100.0 ^b
TS1	950.0 + time offset ^a	662.5 ^b
TS2	1625.0 + time offset ^a	662.5 ^b
TS3	2300.0 + time offset ^a	662.5 ^b
TS4	2975.0 + time offset ^a	662.5 ^b
TS5	3650.0 + time offset ^a	662.5 ^b
TS6	4325.0 + time offset ^a	662.5 ^b

- a. A time offset is introduced to compensate for the time delay caused by the RBW.
- b. The Gate Length is calculated as follows:
 - For Traffic slots, $675\mu\text{s} - \text{Guard period}(16\text{chips}) = 675\mu\text{s} - 12.5\mu\text{s} = 662.5\mu\text{s}$
 - For Downlink Pilot, $75\mu\text{s} - \text{Guard period}(32\text{chips}) = 75\mu\text{s} - 25\mu\text{s} = 50\mu\text{s}$
 - For Uplink Pilot, $125\mu\text{s} - \text{Guard period}(32\text{chips}) = 125\mu\text{s} - 25\mu\text{s} = 100\mu\text{s}$

HSPA/8PSK Enable

You can disable the HSPA/8PSK (Option2FP) functionality by pressing the key or sending the SCPI command, without actually un-installing the HSPA/8PSK option.

NOTE When the HSPA/8PSK Option (Option 2FP) is not installed or is disabled, the state is set to Off.

If this key is set to OFF, the Modulation Scheme will be switched to AUTO and both the Modulation Scheme key and the Mod Format key should be unavailable (grayed out).

Mode	TD-SCDMA
Remote Command	[:SENSE] :RADio:CONFigure:HSDPa [:STATe] 0 1 OFF ON [:SENSE] :RADio:CONFigure:HSDPa [:STATe] ?
Example	:RAD:CONF:HSDP:STAT OFF :RAD:CONF:HSDP:STAT?
Notes	This key is active if the TD-SCDMA HSPA/8PSK option (Option 2FP) license is installed. If the license is not installed, this key will be unavailable (grayed out).
Preset	OFF
State Saved	Saved in instrument state.

Mode Setup

Range	On Off
Key Path	Mode Setup

Restore Mode Defaults

Restore Mode Defaults resets the state for the currently active mode by resetting the mode persistent settings to their factory default values, clearing mode data, and by performing a Mode Preset.

Key Path	Mode Setup
----------	-------------------

Demod

Allows you to specify the demodulation parameters.

Key Path	Mode Setup
----------	-------------------

Scramble Code

Gets and sets the scramble code.

Mode	TD-SCDMA
Remote Command	[:SENSe] :TDEMod:SCODE <integer> [:SENSe] :TDEMod:SCODE?
Example	:TDEM:SCOD 0 :TDEM:SCOD?
Preset	0
State Saved	Saved in instrument state.
Min	0
Max	127
Key Path	Mode Setup, Demod

Uplink Pilot

Specifies the Uplink Pilot synchronization ID sequence (SYNC-UL).

Mode	TD-SCDMA
Remote Command	[:SENSe] :TDEMod:UPTS <integer> [:SENSe] :TDEMod:UPTS?
Example	:TDEM:UPTS 0 :TDEM:UPTS?

Dependencies/Couplings	Value Range: (floor(Scramble Code/4))*8 ~ (floor(Scramble Code/4)+1)*8-1
Preset	0
State Saved	Saved in instrument state.
Min	0
Max	255
Key Path	Mode Setup, Demod

Sync Type

Sets and gets the sync type of Pilot or Midamble.

See [More Information about Sync Type](#)

Mode	TD-SCDMA
Remote Command	[:SENSE] :TDEMod:SYNC PILot MIDamble [:SENSE] :TDEMod:SYNC?
Example	:TDEM:SYNC PIL :TDEM:SYNC?
Preset	PILot
State Saved	Saved in instrument state.
Range	Pilot Midamble
Key Path	Mode Setup, Demod

More Information about Sync Type

- Pilot synchronization searches for either the Uplink Pilot or Downlink Pilot burst and then uses the location of that burst to position all of the rest of the time slots. Synchronization will fail if neither pilot burst is found or if the incorrect Uplink or Downlink Pilot Code ID is set for the Pilot burst present.
- Midamble synchronization searches for the first Uplink traffic burst, positioning it as timeslot TS1. Synchronization will fail if there are Pilot bursts present, if TS0 is present, if there are no traffic bursts present or if the incorrect Basic Midamble Code ID is set.

Switching Point

Gets and sets the switching point. Switching Point is the timeslot number of the last uplink traffic timeslot. Timeslots from the following (next higher numbered) traffic timeslot through the end of the sub-frame are treated as downlink timeslots.

Mode	TD-SCDMA
------	----------

Mode Setup

Remote Command	<code>[:SENSe] :TDEMod:ULSPoint <integer></code> <code>[:SENSe] :TDEMod:ULSPoint?</code>
Example	<code>:TDEM:ULSP 1</code> <code>:TDEM:ULSP?</code>
Preset	1
State Saved	Saved in instrument state.
Min	1
Max	6
Key Path	Mode Setup, Demod

Max Users for Traffic Timeslots

Gets and sets the max user value for TS0~TS6. Allows you to specify the number of maximum users that will be associated with the timeslots specified by the Traffic Timeslots parameter.

Key Path	Mode Setup, Demod
----------	--------------------------

TS0 Gets and sets the max user value for TS0. Allows you to specify the number of maximum users that will be associated with the timeslots 0.

Mode	TD-SCDMA
Remote Command	<code>[:SENSe] :TDEMod:MXUser:TS0 <integer></code> <code>[:SENSe] :TDEMod:MXUser:TS0?</code>
Example	<code>:TDEM:MXUS:TS0 2</code> <code>:TDEM:MXUS:TS0?</code>
Preset	16
State Saved	Saved in instrument state.
Min	2
Max	16
Key Path	Mode Setup, Demod, Max Users for Traffic Timeslots

TS1 Gets and sets the max user value for TS1. Allows you to specify the number of maximum users that will be associated with the timeslots 1.

Mode	TD-SCDMA
Remote Command	<code>[:SENSe] :TDEMod:MXUser:TS1 <integer></code> <code>[:SENSe] :TDEMod:MXUser:TS1?</code>

Example	:TDEM:MXUS:TS1 2 :TDEM:MXUS:TS1?
Preset	16
State Saved	Saved in instrument state.
Min	2
Max	16
Key Path	Mode Setup, Demod, Max Users for Traffic Timeslots

TS2 Gets and sets the max user value for TS2. Allows you to specify the number of maximum users that will be associated with the timeslots 2.

Mode	TD-SCDMA
Remote Command	[:SENSe] :TDEMod:MXUser:TS2 <integer> [:SENSe] :TDEMod:MXUser:TS2?
Example	:TDEM:MXUS:TS2 2 :TDEM:MXUS:TS2?
Preset	16
State Saved	Saved in instrument state.
Min	2
Max	16
Key Path	Mode Setup, Demod, Max Users for Traffic Timeslots

TS3 Gets and sets the max user value for TS3. Allows you to specify the number of maximum users that will be associated with the timeslots 3.

Mode	TD-SCDMA
Remote Command	[:SENSe] :TDEMod:MXUser:TS3 <integer> [:SENSe] :TDEMod:MXUser:TS3?
Example	:TDEM:MXUS:TS3 2 :TDEM:MXUS:TS3?
Preset	16
State Saved	Saved in instrument state.
Min	2
Max	16
Key Path	Mode Setup, Demod, Max Users for Traffic Timeslots

Mode Setup

TS4 Gets and sets the max user value for TS4. Allows you to specify the number of maximum users that will be associated with the timeslots 4.

Mode	TD-SCDMA
Remote Command	[:SENSe] :TDEMod:MXUSer:TS4 <integer> [:SENSe] :TDEMod:MXUSer:TS4?
Example	:TDEM:MXUS:TS4 2 :TDEM:MXUS:TS4?
Preset	16
State Saved	Saved in instrument state.
Min	2
Max	16
Key Path	Mode Setup, Demod, Max Users for Traffic Timeslots

TS5 Gets and sets the max user value for TS5. Allows you to specify the number of maximum users that will be associated with the timeslots 5.

Mode	TD-SCDMA
Remote Command	[:SENSe] :TDEMod:MXUSer:TS5 <integer> [:SENSe] :TDEMod:MXUSer:TS5?
Example	:TDEM:MXUS:TS5 2 :TDEM:MXUS:TS5?
Preset	16
State Saved	Saved in instrument state.
Min	2
Max	16
Key Path	Mode Setup, Demod, Max Users for Traffic Timeslots

TS6 Gets and sets the max user value for TS6. Allows you to specify the number of maximum users that will be associated with the timeslots 6.

Mode	TD-SCDMA
Remote Command	[:SENSe] :TDEMod:MXUSer:TS6 <integer> [:SENSe] :TDEMod:MXUSer:TS6?
Example	:TDEM:MXUS:TS6 2 :TDEM:MXUS:TS6?

Preset	16
State Saved	Saved in instrument state.
Min	2
Max	16
Key Path	Mode Setup, Demod, Max User for Traffic Timeslots

Slot Frequency Reference

Sets and gets the slot frequency reference. Allows you to specify whether the appropriate pilot timeslot or the midamble section of the timeslot will be used as the frequency and phase reference for an individual traffic timeslot.

Mode	TD-SCDMA
Remote Command	[:SENSe] :TDEMod:SREference PILOt MIDamble [:SENSe] :TDEMod:SREference?
Example	:TDEM:SREF PIL :TDEM:SREF?
Preset	PILOt
State Saved	Saved in instrument state.
Range	Pilot Midamble
Key Path	Mode Setup, Demod

Code Channel Detection

Sets and gets the state of Code Channel Detection. If the current timeslot is DwPTS or UpPTS, this key will be grayed out and the value will be set to AUTO.

Mode	TD-SCDMA
Remote Command	[:SENSe] :TDEMod:CDCHannel:DETection AUTO MAN [:SENSe] :TDEMod:CDCHannel:DETection?
Example	:TDEM:CDCH:DET AUTO :TDEM:CDCH:DET?
Preset	AUTO
State Saved	Saved in instrument state.
Range	Auto Man
Key Path	Mode Setup, Demod, More

Mode Setup

Mod Scheme

Sets and gets the modulation scheme. This key is only available when HSPA/8PSK Option (Option 2FP) is installed and the Enable HSPA/8PSK key is set to ON. Otherwise, it will be grayed out and the value will be set to AUTO.

See [More Information about Mode Scheme](#).

Mode	TD-SCDMA
Remote Command	[:SENSe] :TDEMod:MODScheme:AUTO 1 0 ON OFF [:SENSe] :TDEMod:MODScheme:AUTO?
Example	:TDEM:MODS:AUTO ON :TDEM:MODS:AUTO?
Dependencies/Couplings	When the value is Auto, the Modulation Format Key will be grayed out.
Preset	ON
State Saved	Saved in instrument state.
Range	Auto Man
Key Path	Mode Setup, Demod, More

More Information about Mode Scheme

If the Mod Scheme is MAN, you need to specify the modulation format for each channel. If the Mod Scheme is Auto, the measurement will automatically detect the channel's modulation format.

If the current timeslot is DwPTS or UpPTS, this key will be grayed out and set to AUTO.

NOTE The Auto mode is only applied to QPSK, 8PSK and 16QAM. For 64QAM, it only supports MAN mode.

Channel Configuration

Allows you to specify the parameters for the channel. This key will be grayed if the “Code Channel Detection” is “AUTO” and the “Mod Scheme” is “AUTO”.

Key Path	Mode Setup, Demod, More
----------	--------------------------------

Select Code Length Gets and sets the select code length.

Mode	TD-SCDMA
Remote Command	[:SENSe] :TDEMod:SCLength <integer> [:SENSe] :TDEMod:SCLength?

Example	:TDEM:SCL 1 :TDEM:SCL?
Notes	This key is grayed out when “Code Channel Detection” and “Mod Scheme” are both AUTO.
Dependencies/Couplings	Only 1,2,4,8,16 are valid and any number will be clipped to the nearest valid number.
Preset	16
State Saved	Saved in instrument state.
Min	1
Max	16
Key Path	Mode Setup, Demod, More, Channel Configuration

Select All Code Channels Gets and sets the selection mode for the code channel. If the Select All Code Channels is ON, by modifying the modulation format or the midamble shift, the user can change the values of all code channels which have the same code length and at the same time, the Select Code Channel key will be grayed out.

Mode	TD-SCDMA
Remote Command	[:SENSe] :TDEMod:CDCHannel :SALL 1 0 ON OFF [:SENSe] :TDEMod:CDCHannel :SALL? [:SENSe] :TDEMod:CDCHannel :SElect SINGLE ALL [:SENSe] :TDEMod:CDCHannel :SElect ?
Example	:TDEM:CDCH:SALL ON :TDEM:CDCH:SALL?
Preset	ON
State Saved	Saved in instrument state.
Range	On Off
Key Path	Mode Setup, Demod, More, Channel Configuration

Select Code Channel Gets and sets the code channel. The max value for the code Channel should be (Select Code length – 1). The Dispread Channel Code Channel is used, along with the Dispread Channel Spread Code Length, to specify the active code channel and layer used for the channel trace data measurement results. If the Select All Code Channel is ON, this key will be grayed out.

Mode	TD-SCDMA
Remote Command	[:SENSe] :TDEMod:CDCHannel <integer> [:SENSe] :TDEMod:CDCHannel ?

Mode Setup

Example	:TDEM:CDCH 0 :TDEM:CDCH?
Notes	This key is grayed out when “Code Channel Detection” and “Mod Scheme” are both AUTO.
Preset	0
State Saved	Saved in instrument state.
Min	0
Max	Equals (Select Code length – 1)
Key Path	Mode Setup, Demod, More, Channel Configuration

Code Channel Status Gets and sets the Code Channel Status.

Mode	TD-SCDMA
Remote Command	[[:SENSE]:TDEMod:CDCHannel:ACTive <spread_code_length>,<code_channel>,0 1 OFF ON [:SENSE]:TDEMod:CDCHannel:ACTive? <spread_code_length>,<code_channel>
Example	:TDEM:CDCH:ACT 1,0,ON :TDEM:CDCH:ACT? 1,0
Notes	This key is grayed out when “Code Channel Detection” is AUTO.
Preset	OFF
State Saved	Saved in instrument state.
Range	On Off
Key Path	Mode Setup, Demod, More, Channel Configuration

Midamble Shift Specifies the Midamble Shift number.

Mode	TD-SCDMA
Remote Command	[[:SENSE]:TDEMod:MSHift <spread_code_length>,<code_channel>,<integer> [:SENSE]:TDEMod:MSHift? <spread_code_length>,<code_channel>
Example	:TDEM:MSH 1,0,1 :TDEM:MSH? 1,0
Preset	0
State Saved	Saved in instrument state.

Min	0
Max	15
Key Path	Mode Setup, Demod, More, Channel Configuration

Modulation Format Sets and gets the modulation format. If Auto is assigned to a code channel with some spread code length, the modulation format on this code channel will be determined by the measurement.

Mode	TD-SCDMA
Remote Command	[:SENSe] :TDEMod:MODFormat <integer>, <integer>, AUTO QPSK PSK8 QAM16 QAM64 [:SENSe] :TDEMod:MODFormat? <integer>, <integer>
Notes	In the remote commands, the first integer stands for spread_code_length and the second integer stands for code_channel.
Example	:TDEM:MODF 1,0,AUTO :TDEM:MODF? 1,0
Dependencies/Couplings	If the “Mod Scheme” is “AUTO”, this key will be grayed.
Preset	AUTO
State Saved	Saved in instrument state.
Range	Auto QPSK 8PSK 16QAM 64QAM
Key Path	Mode Setup, Demod, More, Channel Configuration

Phase Shift Specifies the Phase Shift.

Mode	TD-SCDMA
Remote Command	[:SENSe] :TDEMod:PHASe:SHIFt <integer>, <integer>, <real> [:SENSe] :TDEMod:PHASe:SHIFt? <integer>, <integer>
Notes	In the remote commands, the first integer stands for spread_code_length and the second integer stands for code_channel.
Example	:TDEM:PHAS:SHIF 1,0,0.0 :TDEM:PHAS:SHIF? 1,0
Preset	0.00
State Saved	Saved in instrument state.
Min	-360.00
Max	360.00
Key Path	Mode Setup, Demod, More, Channel Configuration, More

Mode Setup

Show Configuration Setup Shows all values of the Channel Configuration. If any other menu is displayed, this window will exit.

Mode	TD-SCDMA
Notes	This key is grayed out when “Code Channel Detection” and “Mod Scheme” are both AUTO.
Key Path	Mode Setup, Demod, More, Channel Configuration

Timing Reference

Sets and gets the timing reference.

Mode	TD-SCDMA
Remote Command	<code>[:SENSe] :TDEMod:TREFerence DPTS UPTS TRIG</code> <code>[:SENSe] :TDEMod:TREFerence?</code>
Example	<code>:TDEM:TREF DPTS</code> <code>:TDEM:TREF?</code>
Preset	DPTS
State Saved	Saved in instrument state.
Range	DwPTS UpPTS Trigger
Key Path	Mode Setup, Demod, More

Advanced

Allows you to specify the advanced configuration parameters.

Key Path	Mode Setup, Demod, More
----------	--------------------------------

Filter Alpha Sets and gets the filter alpha. You can set the measurement filter (Root-raised Cosine) alpha.

Mode	TD-SCDMA
Remote Command	<code>[:SENSe] :TDEMod:ALPHa <real></code> <code>[:SENSe] :TDEMod:ALPHa?</code>
Example	<code>:TDEM:ALPH 0.22</code> <code>:TDEM:ALPH?</code>
Preset	0.22
State Saved	Saved in instrument state.
Min	0.05

Max 1.0
 Key Path **Mode Setup, Demod, More, Advanced**

Active Slot Threshold Sets and gets the active slot threshold. You can adjust the Active Slot detection threshold, dB below the slot with the largest measured power.

Mode TD-SCDMA
Remote Command [:SENSe]:TDEMod:THReshold:SLOT <real>
 [:SENSe]:TDEMod:THReshold:SLOT?
 Example :TDEM:THR:SLOT -30
 :TDEM:THR:SLOT?
 Preset -30.000dBc
 State Saved Saved in instrument state.
 Min -120.000dBc
 Max 0.000dBc
 Key Path **Mode Setup, Demod, More, Advanced**

Active Channel Threshold Sets and gets the active slot threshold. Active Channel Threshold lets you set the threshold above which a code channel is detected active and included in the Composite Reference waveform. The units are dBc (dB below the total power within the Analysis Timeslot).

Mode TD-SCDMA
Remote Command [:SENSe]:TDEMod:THReshold:CHANnel <real>
 [:SENSe]:TDEMod:THReshold:CHANnel?
 [:SENSe]:TDEMod:THReshold:CHANnel:AUTO ON|OFF|0|1
 [:SENSe]:TDEMod:THReshold:CHANnel:AUTO?
 Example :TDEM:THR:CHAN -30.000
 :TDEM:THR:CHAN?
 :TDEM:THR:CHAN:AUTO OFF
 :TDEM:THR:CHAN:AUTO?
 Preset -30.000dBc
 ON
 State Saved Saved in instrument state.
 Min -120.000dBc
 Max 0.000dBc
 Key Path **Mode Setup, Demod, More, Advanced**

Mode Setup

EVM Result IQ Offset Sets and gets the EVM result IQ offset.

Mode	TD-SCDMA
Remote Command	[[:SENSE]:TDEMod:EVMResult:IQOffset STANard EXclude [:SENSE]:TDEMod:EVMResult:IQOffset?
Example	:TDEM:EVMR:IQOF STAN :TDEM:EVMR:IQOF?
Preset	STAN
State Saved	Saved in instrument state.
Range	Std Exclude
Key Path	Mode Setup, Demod, More, Advanced

Mirror Frequency Spectrum Sets and gets the mirror frequency spectrum value to correctly demodulate frequency spectrums that are mirrored (flipped) about the center frequency.

Mode	TD-SCDMA
Remote Command	[[:SENSE]:TDEMod:SPECTrum:MIRROR Normal INVert [:SENSE]:TDEMod:SPECTrum:MIRROR?
Example	:TDEM:SPEC:MIRR NORM :TDEM:SPEC:MIRR?
Preset	NORMal
State Saved	Saved in instrument state.
Range	Normal Invert
Key Path	Mode Setup, Demod, More, Advanced

Normalize Sets and gets the normalize value. When Normalize is set to ON, the analyzer applies trace data normalization to the trace data results.

Mode	TD-SCDMA
Remote Command	[[:SENSE]:TDEMod:NORMalize 1 0 ON OFF [:SENSE]:TDEMod:NORMalize?
Example	:TDEM:NORM ON :TDEM:NORM?
Preset	ON
State Saved	Saved in instrument state.
Range	On Off

Key Path **Mode Setup, Demod, More, Advanced**

Multi-Carrier Demod

Sets and gets the current status of Multi-Carrier Demod.

Mode	TD-SCDMA
Remote Command	[:SENSe] :TDEMod:MCARrier 1 0 ON OFF [:SENSe] :TDEMod:MCARrier?
Example	:TDEM:MCAR ON :TDEM:MCAR?
Preset	OFF
State Saved	Saved in instrument state.
Range	On Off
Key Path	Mode Setup, Demod, More

Mode Setup

Peak Search

Pressing the Peak Search key displays the Peak Search menu and places the selected marker on the trace point with the maximum y-axis value for that marker's trace. The Peak Search features allow you to define specific search criteria to determine which signals can be considered peaks, excluding unwanted signals from the search.

If **Same as "Next Peak" Criteria** is selected, and either **Pk Excursion** or **Pk Threshold** are on, a signal must meet those criteria. If no valid peak is found, a message is generated and the marker is not moved. When **Highest Peak** is on, or both **Pk Excursion** and **Pk Threshold** are off, the marker is always placed at the point on the trace with the maximum y-axis value, even if that point is on the very edge of the trace (exception: negative frequencies and signals close to the LO are not searched at all).

Pressing Peak Search with the selected marker off causes the selected marker to be set to **Normal** at the center of the screen, then a peak search is immediately performed.

Key Path	Front-panel key
Instrument S/W Revision	Prior to A.02.00

Peak Search

Recall

Recall functionality is common across multiple Modes and Measurements. These common features are described in this section.

The Recall feature prompts you to answer the questions: What do you want to recall? And to where do you want to recall it? Once these questions are answered the recall can occur. The options in this menu answer the question "What do you want to Recall?"

The options are State, Trace and Data. (Screen Image can be saved, but not recalled.) The default paths for Recall are data type dependent and are the same as for Save.

Remote Command Notes	No remote command directly controls the Recall Type that this key controls. The Recall type is a node in the :MMEM:LOAD command. An example is :MMEM:LOAD:STATe <filename>.
Key Path	Front-panel key
Instrument S/W Revision	Prior to A.02.00

State

Accesses a menu that enables you to recall a State that has previously been saved. Recalling a saved state returns the analyzer as close as possible to the mode context and may cause a mode switch if the file selected is not for the current active mode. A State file can be recalled from either a register or a file. Once you pick the source of the recall in the State menu, the recall will occur.

When this key is pressed, you have determined what they want to recall is **State**. Recalling **State** is used to return as close as possible to the mode context of the save. Recalling State may cause a mode switch if the file selected is not for the currently active mode. This menu key will not actually cause the recall, since the recall feature still needs to know from where to recall the state. **State** can be recalled from either a register or a file. Pressing this key will bring up the State menu that provides you with the option of where to retrieve the state. For quick recalls, the State menu lists 6 registers to recall from or you can select a file to recall from.

Example	MMEM:LOAD:STAT "MyStateFile.state" This loads the state file data (on the default file directory path) into the instrument state.
Remote Command Notes	See "Open" on page 1182 .
Key Path	Recall
Mode	All
Instrument S/W Revision	Prior to A.02.00

In measurements that support saving Traces, for example, Swept SA, the Trace data is saved along with

Recall

the State in the State file. When recalling the State, the Trace data is recalled as well. Traces are recalled exactly as they were stored, including the writing mode and update and display modes; so if a Trace was updating and visible when the State was saved, it will come back updating and visible; hence its data will be rewritten right away. So if using State to save and recall traces, any trace whose data must be preserved should be placed in View or Blank before saving.

This creates the following table describing the Trace Save/Recall possibilities:

You want to recall state and one trace's data, leaving other traces unaffected.	Save Trace+State from 1 trace. Make sure that no other traces are updating (they should all be in View or Blank) when the save is performed.	On Recall, specify the trace you want to load the one trace's data into. This trace will load in View. All other traces' data will be unaffected, although their trace mode will be as it was when the state save was performed.
You want to recall all traces	Save Trace+State from ALL traces.	On Recall, all traces will come back in View (or Blank if they were in Blank or Background when saved)
You want all traces to load exactly as they were when saved.	Save State	On recall, all traces' mode and data will be exactly as they were when saved. Any traces that were updating will, of course, have their data immediately overwritten.

Register 1 thru Register 6

Selecting any one of these register keys causes the State of the mode from the specified Register to be recalled. Each of the register keys annotates whether it is empty or at what date and time it was last modified.

Registers are shared by all modes, so recalling from any one of the 6 registers may cause a mode switch to the mode that was active when the save to the Register occurred.

After the recall completes, the message "Register <register number> recalled" appears in the message bar.

Selecting any one of these register menu keys: **Register 1**, **Register 2**, **Register 3**, **Register 4**, **Register 5**, **Register 6** causes the state of the mode from the specified Register to be recalled. The registers are provided for easy saving and recalling, since you do not have to specify a filename or navigate to a specific file. The date will follow the format specified in the Date Format setting under the **Control Panel**. The time will show hours, minutes and seconds.

Example	*RCL 1
Key Path	Recall, State
Readback	Date and time with seconds resolution of the last Save is displayed on the key, or "(empty)" if no prior save operation performed to this register.

Instrument S/W Revision Prior to A.02.00

Example *RCL 2

Key Path **Recall, State**

Readback Date and time with seconds resolution of the last Save is displayed on the key, or "(empty)" if no prior save operation performed to this register.

Instrument S/W Revision Prior to A.02.00

Example *RCL 3

Key Path **Recall, State**

Readback Date and time with seconds resolution of the last Save is displayed on the key, or "(empty)" if no prior save operation performed to this register.

Instrument S/W Revision Prior to A.02.00

Example *RCL 4

Key Path **Recall, State**

Readback Date and time with seconds resolution of the last Save is displayed on the key, or "(empty)" if no prior save operation performed to this register.

Instrument S/W Revision Prior to A.02.00

Example *RCL 5

Key Path **Recall, State**

Readback Date and time with seconds resolution of the last Save is displayed on the key, or "(empty)" if no prior save operation performed to this register.

Instrument S/W Revision Prior to A.02.00

Example *RCL 6

Key Path **Recall, State**

Readback Date and time with seconds resolution of the last Save is displayed on the key, or "(empty)" if no prior save operation performed to this register.

Instrument S/W Revision Prior to A.02.00

From File\ File Open

Brings up the File Open standard Windows® dialog and its corresponding **File Open** key menu.

Recall

When you first enter this dialog, the State File default path is in the Look In: box in this File Open dialog. The File Open dialog is loaded with the file information related to the State Save Type. The first *.state file is highlighted. The only files that are visible are the *.state files and the Files of type is *.state, since .state is the file suffix for the State Save Type. For more details, refer to “File Open Dialog and Menu” on page 1197.

Restriction and Notes	Brings up Open dialog for recalling a State Save Type
Key Path	Recall, State
Instrument S/W Revision	Prior to A.02.00

Open Recalling State function first must verify the file is recallable in the current instrument by checking the software version and model number of the instrument. If everything matches, a full recall proceeds by aborting the currently running measurement, and then loading the State from the saved state file to as close as possible to the context in which the save occurred. You can open state files from any mode, so recalling a State File switches to the mode that was active when the save occurred. After switching to the mode of the saved state file, mode settings and data (if any for the mode) are loaded with values from the saved file. The saved measurement of the mode becomes the newly active measurement and the data relevant to the measurement (if there is any) is recalled.

If there is a mismatch between file version or model number or instrument version or model number, the recall still tries to recall as much as possible and it returns a warning message of what it did.

NOTE No Trace data is loaded when recalling a State File. Measurements that support loading of trace data will include a Trace key in the Recall menu and will load State + Trace data from .trace files under that key.

Remote Command:	:MMEMory:LOAD:STATe <filename>
Example:	:MMEM:LOAD:STAT "myState.state" recalls the file myState.state on the default path
Restriction and Notes:	Auto return to the State menu and the Open dialog goes away. Advisory Event "Recalled File <file name>" after recall is complete.

Remote Command Notes: Although the trace data is included in the .state file it is not recalled; that is left for .trace files only for measurements that support recalling of trace data. Errors are generated if the specified file is empty or does not exist, or there is a file type mismatch.

Key Path: **Recall, State, From File...**

Instrument S/W Revision: Prior to A.02.00

The state of a mode includes all of the variables affected by doing a full preset. It not only recalls Mode Preset settings, but it also recalls all of the mode persistent settings and data if the mode has either. Each mode determines whether data is part of mode state and if the mode has any persistent settings. **Recall State** also recalls all of the **Input/Output** system settings, since they are saved with each State File for each mode.

The Recall State function does the following:

Verifies that the file is recallable on this instrument using the version number and model number.

Aborts the currently running measurement.

Clears any pending operations.

Switches to the mode of the selected Save State file.

Sets mode State and Input/Output system settings to the values in the selected Saved State file.

Limits settings that differ based on model number, licensing or version number.

Makes the saved measurement for the mode the active measurement.

Clears the input and output buffers.

Status Byte is set to 0.

Executes a *CLS

Trace (+State)

When this key is pressed, you have determined what you want to recall is **Trace**. Trace files include the state of the mode they were saved from as well as the trace data, with internal flags to indicate which

Recall

trace you were trying to save which may include ALL traces. They are otherwise identical to State files. Recalling **Trace** may cause a mode switch if the file selected is not for the currently active mode.

Not all modes support saving of trace data with the state; and for modes that do, not all measurements do. The Trace key is grayed out for measurements that do not support trace recall. It is blanked for modes that do not support trace recall.

This key will not actually cause the recall, since the recall feature still needs to know from which file to recall the trace and which trace to recall it into. Pressing this key will bring up the Recall Trace menu that provides you with the option of where to retrieve the trace.

For quick recalls, the Trace menu lists 5 registers to recall from or you can select a file to recall from.

Example	MMEM:LOAD:TRAC TRACE2,"MyTraceFile.trace" !This loads the trace file data (on the default file directory path) into the specified trace. :MMEM:LOAD:TRAC:REG TRACE1,2 ! restores the trace data in register 2 to Trace 1
Key Path	Recall
Mode	SA
Instrument S/W Revision	Prior to A.02.00

Register 1 thru Register 5

Selecting any one of these register keys causes the Traces and State from the specified Register to be recalled. Each of the register keys annotates whether it is empty or at what date and time it was last modified.

Trace registers are shared by all modes, so recalling from any one of the 5 registers may cause a mode switch to the mode that was active when the save to the Register occurred.

After the recall completes, the message "Trace Register <register number> recalled" appears in the message bar.

Selecting any one of these register menu keys: **Register 1, Register 2, Register 3, Register 4, Register 5** causes the traces and state of the mode from the specified Register to be recalled. The registers are provided for easy saving and recalling, since you do not have to specify a filename or navigate to a specific file. The date will follow the format specified in the Date Format setting under the **Control Panel**. The time will show hours, minutes and seconds.

Key Path	Recall, Trace
Readback	Date and time with seconds resolution of the last Save is displayed on the key, or "(empty)" if no prior save operation performed to this register.
Instrument S/W Revision	Prior to A.02.00
Key Path	Recall, Trace

Readback	Date and time with seconds resolution of the last Save is displayed on the key, or "(empty)" if no prior save operation performed to this register.
Instrument S/W Revision	Prior to A.02.00
Key Path	Recall, Trace
Readback	Date and time with seconds resolution of the last Save is displayed on the key, or "(empty)" if no prior save operation performed to this register.
Instrument S/W Revision	Prior to A.02.00
Key Path	Recall, Trace
Readback	Date and time with seconds resolution of the last Save is displayed on the key, or "(empty)" if no prior save operation performed to this register.
Instrument S/W Revision	Prior to A.02.00
Key Path	Recall, Trace
Readback	Date and time with seconds resolution of the last Save is displayed on the key, or "(empty)" if no prior save operation performed to this register.
Instrument S/W Revision	Prior to A.02.00

To Trace

These key selections let you pick which Trace to recall the saved trace into; either 1, 2, 3, 4, 5, or 6. Not all modes have the full 6 traces available. The default is the currently selected trace, selected in this menu or in the Trace/Det, Export Data, Import Data, or Save Trace menus, except if you have chosen All then it remains chosen until you specifically change it to a single trace.

If the .trace file is an "all trace" file, "**To Trace**" is ignored and the traces each go back to the trace they were saved from.

Once selected, the key returns back to the Recall Trace menu and the selected Trace number is annotated on the key. Now you have selected exactly where the trace needs to be recalled. In order to trigger a recall of the selected Trace, you must select the **Open** key in the Recall Trace menu.

Key Path	Save, Data, Trace
Mode	SA
Instrument S/W Revision	Prior to A.02.00

Open...

Pressing **Open** brings up the File Open standard Windows dialog and its corresponding File Open key menu. When you navigate to this selection, they have already determined they are recalling Trace and

Recall

now they want to specify from which file to do the recall.

When you first enter this dialog, the State File default path is in the Look In: box in this File Open dialog. The File Open dialog is loaded with the file information related to the State Save Type. The first *.trace file is highlighted. Also, the only files that are visible are the *.trace files and the Files of type is *.trace, since .trace is the file suffix for the Trace Save Type. For more details, refer to [“File Open Dialog and Menu” on page 1197](#).

Restriction and Notes	Brings up Open dialog for recalling a Trace Save Type
Key Path	Recall, Trace
Mode	SA
Instrument S/W Revision	Prior to A.02.00

Open Recalling Trace first must verify the file is recallable in this instrument by checking instrument software version and model number, since it includes State. If everything matches, a full recall proceeds by aborting the currently running measurement, loads the state from the saved state file to as close as possible to the context in which the save occurred. Users can open .trace files from any mode that supports them, so recalling a Trace File switches to the mode that was active when the save occurred. After switching to the mode of the saved state file, mode settings and data (if any for the mode) are loaded with values from the saved file and the saved measurement of the mode becomes the newly active measurement and the data relevant to the measurement (if there is any) is recalled.

Once the state is loaded the trace data must be loaded. The internal flags are consulted to see which trace to load and the "To Trace" setting to see where to load it. Trace data is always loaded with the specified trace set to View, so that the data is visible and not updating (so as not to wipe out the recalled data). If the file is an "all trace" file, all traces are loaded with the saved data (to the original trace the data was saved from) and set to View. Traces whose data is not loaded are restored to the update state that existed when they were saved.

In every other way a Trace load is identical to a State load. See section [“Open” on page 1182](#) for details.

Restriction and Notes	Auto return to the Trace menu and the Open dialog goes away. Advisory Event "Recalled File <file name>" after recall is complete.
Remote Command	:MMEMory:LOAD:TRACe TRACE1 TRACE2 TRACE3 TRACE4 TRACE5 TRACE6 , <filename> :MMEMory:LOAD:TRACe:REGister TRACE1 TRACE2 TRACE3 TRACE4 TRACE5 TRACE6 , <integer>

Remote Command Notes	<p>Some modes and measurements do not have available all 6 traces. Phase Noise mode command, for example, is: <code>MMEMory:LOAD:TRACe TRACE1 TRACE2 TRACE3,<filename></code></p> <p>The load trace command actually performs a load state, which in the Swept SA measurement includes the trace data. However it looks in the recalled state file to see how it was flagged at save time. The possibilities are:</p> <p>If the trace file was saved using one of the TRACE# enums, it is flagged as a single trace save file. The trace that was flagged as the one that was saved, is loaded to the trace specified. The trace is loaded with update off and display on, and none of the other traces are loaded.</p> <p>If the trace file was saved using one the ALL enum, it is flagged as an "all traces" file. And all traces will be loaded. All of the traces are loaded with Update=Off to keep them from updating, regardless of the setting of "Recall State w/Trace Update".</p>
Example	<p><code>:MMEM:LOAD:TRAC TRACE2,"myState.trace"</code> recalls the file myState.trace on the default path; if it is a "single trace" save file, that trace is loaded to trace 2, and will is set to be not updating.</p> <p><code>:MMEM:LOAD:TRAC:REG TRACE1,2</code> restores the trace data in register 2 to Trace 1</p>
Key Path	Recall, Trace, Open...
Instrument S/W Revision	Prior to A.02.00

Data (Mode Specific)

Importing a data file loads data that was previously saved from the current measurement or from other measurements and/or modes that produce the same type of data. The Import Menu only contains Data Types that are supported by the current measurement.

For any given mode, the Export Data and Import Data menus match, but keys in Import Data are blanked if the data type is supported for Save but not for Recall.

Since the commonly exported data files are in .csv format, the data can be edited by you prior to importing. This allows you to export a data file, manipulate the data in Excel (the most common PC Application for manipulating .csv files) and then import it.

Importing Data loads measurement data from the specified file into the specified or default destination, depending on the data type selected. Selecting an Import Data menu key will not actually cause the importing to occur, since the analyzer still needs to know from where to get the data. Pressing the Open key in this menu brings up the Open dialog and Open menu that provides you with the options from where to recall the data. Once a filename has been selected or entered in the Open menu, the recall will occur as soon as the Open key is pressed. See section [“File Open Dialog and Menu” on page 1197](#) for more details.

Remote Command Notes	No SCPI command directly controls the Data Type that this key controls. The Data Type is included in the MMEM:LOAD commands.
----------------------	--

Recall

Key Path	Recall
Mode	SA VSA
Preset	<mode specific>; Is not affected by Preset, but is reset during Restore Mode Defaults and survives subsequent running of the mode
Readback	SA: Trace 1 Trace 2 Trace 3 Trace 4 Trace 5 Trace 6 VSA: Trace to Data 1 Trace to Data 2 Trace to Data 3 Trace to Data 4 Trace to Data 5 Trace to Data 6
Instrument S/W Revision	Prior to A.02.00

Trace

This key selects the Traces as the data type to be imported with this recall request. It brings up the Trace Menu that lets you select which Trace to import the data into.

This key is grayed out when measurements are running that do not support trace importing.

For Vector Signal Analyzer Mode:

the trace data is loaded into the selected data register. Trace data registers are temporary storage places for trace data. They allow you to view past results next to current measurement results, and are also used in some functions like user defined filters. They are measurement global, so you can import data into a register while in the Digital Demod measurement and view it later while in the Vector measurement. Data registers are cleared when the measurement application is terminated, but not when you change Modes and return.

If the recalled file was saved with header information, the trace will initially be displayed with the same formatting and scaling as it had when it was saved. If headers are not saved, the scaling and format are set to defaults when the trace is recalled.

The following trace data formats may be imported:

- Text and comma-separated variable (CSV)

- Text

- SDF.

Option 200 also allows import of these additional formats:

- Matlab 4

- Matlab 5

- Matlab HDF5

- N5110A compatible binary

Example `MMEM:LOAD:TRAC:DATA TRACE2,"MyTraceFile.csv"`

This loads the trace file data (on the default file directory path) into the specified trace.

Recall

Instrument S/W Revision Prior to A.02.00

Amplitude Correction

Pressing this key selects the Amplitude Corrections as the data type to be imported with this recall request. This key brings up the Amplitude Correction Menu that allows you to select which Amplitude Correction to recall.

A set of preloaded Corrections files can be found in the directory
/My Documents/ EMC Limits and Ampcor.

Under this directory, the directory called Ampcor (Legacy Naming) contains a set of legacy corrections files, generally the same files that were supplied with older Agilent EMI analyzers, that use the legacy suffixes .ant, .oth, .usr, and .cbl, and the old 8-character file names. In the directory called Ampcor, the same files can be found, with the same suffixes, but with longer, more descriptive filenames.

Example	MMEM:LOAD:CORR 2,"MyCorrectionsData.csv" This loads the file of corrections data (on the default file directory path) into the specified correction table of date (2).
Dependencies/Couplings	Correction data is not available from all Measurements. In that case, the key will be grayed out. The key will not show if no measurements in the Mode support it. When a correction is loaded from mass storage, it is automatically turned on. This also turns on the global "Apply Corrections" function. Only the first correction array (Correction 1) supports antenna units. Note that this means that a correction file with an Antenna Unit can only be loaded into the Corrections 1 register. Consequently only for Correction 1 does the dropdown in the Recall dialog include .ant, and if an attempt is made to load a correction file into any other Correction register which DOES contain an antenna unit, a Mass Storage error is generated.
Key Path	Recall, Data
Mode	SA EDGE GSM
Preset	1 It is not part of Preset, but is reset by Restore Input/Output Defaults and survives subsequent running of the mode.
State Saved	Saved in instrument state.
Readback	1 2 3 4
Instrument S/W Revision	A.02.00

Amplitude Correction 1, 2, 3, 4 These menu key selections let you pick which Amplitude Correction to recall; either 1, 2, 3, or 4. The default is 1. Once selected, the key returns back to the Import Data menu and the selected Amplitude Correction number is annotated on the key. Now exactly what needs to be recalled has been selected. To trigger a recall of the selected Amplitude Correction, you must select the File Open key in the Import Data menu.

An example of using this menu is: if you select 4 and then continues on to the File Open menu, the amplitude correction table 4 will be recalled from the file selected or entered in File Name option in the File Open dialog. See “File Open Dialog and Menu” on page 1197 for more details.

Antenna corrections are a particular kind of Amplitude Corrections – they are distinguished by having the Antenna Unit set to a value other than None. See the Input/Output chapter discussion of Amplitude Corrections for details on Antenna Units.

Key Path	Recall, Data, Amplitude Correction
Mode	SA EDGE GSM
Readback	1
Instrument S/W Revision	A.02.00

Key Path	Recall, Data, Amplitude Correction
Mode	SA EDGE GSM
Readback	2
Instrument S/W Revision	A.02.00

Key Path	Recall, Data, Amplitude Correction
Mode	SA EDGE GSM
Readback	3
Instrument S/W Revision	A.02.00

Key Path	Recall, Data, Amplitude Correction
Mode	SA EDGE GSM
Readback	4
Instrument S/W Revision	A.02.00

Limit Line

This key selects the Limit Lines as the data type to be imported with this recall request. It brings up the Limit Line Menu that lets you select which Limit Line to import the data into. This key is grayed out when SA measurements are running that do not support limit line importing.

A set of preloaded Corrections files can be found in the directory

/My Documents/ EMC Limits and Ampcor.

Under this directory, the directory called Limits (Legacy Naming) contains a set of legacy limits, generally the same files that were supplied with older Agilent EMI analyzers, that use the legacy suffix .lim, and the old 8-character file names. In the directory called Limits, the same files can be found, with

Recall

the same suffix, but with longer, more descriptive filenames.

Example	MMEM:LOAD:LIM LLINE1,"MyLimitsFile.csv" This loads the limit line file data (on the default file directory path) into the specified limit line.
Dependencies/Couplings	Some Measurements do not allow the use of limit lines, so the key will be grayed out. The key will not show if no measurements in the Mode support it. When a limit line is loaded from mass storage, it is automatically turned on. This allows you to see it, thus confirming the load.
Key Path	Recall, Data
Mode	SA
Preset	1; not part of Preset, but is reset by Restore Mode Defaults and survives power cycles
State Saved	Saved in State
Readback	selected Limit Line
Readback	1 2 3 4 5 6
Instrument S/W Revision	A.02.00

Limit Line 1, 2, 3, 4, 5, 6 These keys let you pick which Limit Line to import the data into; either 1 or 2. The default is 1. Once selected, the key returns back to the Import Data menu and the selected Limit Line number is annotated on the key. Now you have selected exactly what needs to be imported. In order to trigger an import of the selected Limit Line, you must select the Open key in the Import Data menu.

An example of using this menu is: If you select 2 and continue to the File Open menu, the Limit Line 2 will be imported from the file selected or entered in File Name option in the File Open dialog.

Key Path	Recall, Data, Limit Line
Mode	SA
Instrument S/W Revision	A.02.00

Capture Buffer

Capture Buffer functionality is not available for all measurements. The captured data is raw data (unprocessed).

Example	MMEM:LOAD:CAPT "MyCaptureData.bin" This loads the file of capture data (on the default file directory path) into the instrument.
Dependencies/Couplings	Capture buffer data is not available from all Measurements. In that case, the key will be grayed out. The key will not show if no measurements in the Mode support it.

Key Path	Recall, Data
Mode	WCDMA
Instrument S/W Revision	Prior to A.02.00

Zone map

A map file contains zone definitions that will help simplify making measurements of frequently used signals. The OFDMA frame structure can contain multiple-zone definitions for the uplink and downlink subframes and multiple data burst allocations. You can recall map files in which you have saved complicated OFDMA frame analysis zone definitions; this can save you time and ensure the accuracy of repeat measurements. map files are also useful for recreating measurement settings so they can be used by other users.

Example	MMEM:LOAD:ZMAP "MyZonemapFile.omf" This loads the file of zone map data (on the default file directory path) into the custom map.
Dependencies/Couplings	Zone map data is not available from all Measurements. In that case, the key will be grayed out. The key will not show if no measurements in the Mode support it.

Key Path	Recall, Data
Mode	OFDMA WIMAX
Instrument S/W Revision	Prior to A.02.00

Recorded Data

This allows you to recall previously saved, recorded data for analysis.

This feature is only available with 89601X VSA Option 200 and Option G01.

Example	MMEM:LOAD:REC "MyRecording.sdf"
Key Path	Recall, Data (Import)
Mode	VSA
Notes	Available file types are: <ul style="list-style-type: none"> • CSV (Comma delimited) (*.csv) • MAT-File (*.mat) • MAT-File (Version 4) (*.mat) • MAT-File (HDF5) (*.mat;*.hdf;*.h5) • N5110A Waveform (*.bin) • SDF (Fast) (*.sdf;*.dat) • SDF (Export) (*.sdf;*.dat) • Text (Tab delimited) (*.txt)

Recall

Instrument S/W Revision Prior to A.02.00

Open...

Pressing **File Open** brings up the File Open standard Windows dialog and the File Open key menu. When you navigate to this selection, they have already determined they are recalling a specific Data Type and now they want to specify which file to open.

When you first enter this dialog, the path is in the Look In: field in this File Open dialog depends on which import data type you navigated here from.

The only files that are visible are those specific to the file type being recalled.

Restriction and Notes Brings up Open dialog for recalling a <mode specific> Save Type

Key Path **Recall, Data**

Instrument S/W Revision Prior to A.02.00

Open The import starts by checking for errors. Then the import can start. For all data types, the actual import starts by aborting the currently running measurement. Then the import does data type specific behavior:

Trace Import: A trace cannot be imported if the trace points in the file do not match the sweep points in the mode. If this happens, an error is generated. When a trace is imported, then **Trace Update** is always turned OFF for that trace and **Trace Display** is always turned ON. The trace file has meta data. If the meta data in the file does not match the corresponding SA state, the dirty marker is displayed.

Limit Line Import: The instrument cannot mix Limits domains (X Axis Unit must be Frequency or Time for both Limits). So when a Limits file is loaded, the analyzer will go to the Limits domain (X Axis Unit) of that file. If this changes the Limits domain from what it was before the file was loaded, all Limits data in both Limits sets will be erased before the data loads. There will be no warning if this occurs, so care should be taken to know the domain of the file you are loading.

When a Limit is loaded it will be turned ON. The Margin settings will match those when the limit was saved.

Amplitude Correction Import: When an amplitude correction data file is imported, the selected amplitude correction table is loaded with the data in the imported file. Also, the x axis interpolation value for that corrections table is recalled from the file and the correction table is interpolated across the entire span. Then the selected amplitude correction table is turned on (**Amplitude Correction ON** and **Amplitude Corrections Apply** set to Yes).

When the Amplitude Correction is an Antenna correction and the Antenna Unit in the file is not None, the Y Axis Unit setting will change to match that of the file.

Remote Command :MMEMory:LOAD:TRACe:DATA
TRACE1 | TRACE2 | TRACE3 | TRACE4 | TRACE5 | TRACE6, <filename>

Example :MMEM:LOAD:TRAC DATA TRACE2,"myTrace2.csv" imports the 2nd trace from the file myTrace2.csv in the default path.

Remote Command Notes	Traces cannot be recalled from a trace data file that was saved with ALL traces selected. Errors are reported if the file is empty or missing, or if the file type does not match.
Mode	SA
Instrument S/W Revision	Prior to A.02.00
Remote Command	:MMEMory:LOAD:TRACe:DATA D1 D2 D3 D4 D5 D6 , <filename> [, CSV TXT SDF]
Example	:MMEM:LOAD:TRAC:DATA D1,"TRC1.TXT",TXT
Restriction and Notes	If you are not licensed to recall a particular file type, then an error –203.9010 will be returned. If the file format cannot be determined or the file cannot be recalled successfully, then an error –250.5290 is returned. If the recall is successful, then advisory 0.1600 is shown.
Remote Command Notes	If the file format parameter is not included in the SCPI command, the file format is determined by the file name extension. If this is not sufficient, the file is scanned to determine the format.
Key Path	Recall, Data (Import), Trace (to), Open . . .
Mode	VSA
Instrument S/W Revision	Prior to A.02.00
Remote Command	:MMEMory:LOAD:CORRection 1 2 3 4, <filename>
Example	:MMEM:LOAD:CORR 2 "myAmpcor.csv" recalls the Amplitude Correction data from the file myAmpcor.csv on the default directory to the 2nd Amplitude Correction table, and turns on table 2.
Dependencies/Couplings	Amplitude Correction <number> is ON, Amplitude Corrections Apply is set to Yes, Amplitude Correction <number> interpolation is recalled from the file and the interpolation occurs for that table.

Recall

Remote Command Notes Errors are generated if the specified file is empty or missing, or if there is a file type mismatch.

Mode SA|EDGE|GSM

Instrument S/W Revision Prior to A.02.00

Remote Command :MMEMory:LOAD:LIMit LLINE1|LLINE2,<filename>

Example :MMEM:LOAD:LIM LLINE2,"myLimitLine2.csv" imports the 2nd Limit Line from the file myLimitLine2.csv in the default path.

Remote Command Notes Errors are reported if the file is empty or missing, or if the file type does not match.

SCPI Status Bits/OPC
Dependencies Sequential - aborts the current measurement

Key Path **Recall, Data, File Open**

Mode SA

Readback floppy icon in the settings bar

Instrument S/W Revision Prior to A.02.00

Recall captured data for reuse in demod measurements using the Load Capture Buffer functionality. This function is enabled for 'Code Domain' and 'Modulation Accuracy' measurements only.

Remote Command :MMEMory:LOAD:CAPTured <filename>

Restriction and Notes Errors are reported if the file is empty or missing, or if the file type does not match.

Example :MMEM:LOAD:CAPT "My
Documents\WCDMA\data\IQ\captureBuffer\myCaptureBuffer.bin"

Key Path **Recall, Data, File Open**

Mode WCDMA

Instrument S/W Revision Prior to A.02.00

Remote Command :MMEMory:LOAD:RECORDing <filename>

Example :MMEM:LOAD:REC "MyRecording.sdf"

Remote Command Notes SCPI reflects the action performed when this key is selected and File Open is pressed.

Key Path **Recall, Data (Import), Recorded Data, Open . . .**

Mode VSA

Instrument S/W Revision Prior to A.02.00

Remote Command :MMEMory:LOAD:ZMAP <filename>

Example :MMEM:LOAD:ZMAP "myZoneMap.omf" recalls the Zone map data from the file myZoneMap.omf on the default directory to the Custom map for Modulation Analysis measurement.

Key Path **Recall, Data, Zone map**

Mode WIMAXOFDMA

Instrument S/W Revision Prior to A.02.00

File Open Dialog and Menu

The **File Open** is a standard Windows dialog and has a **File Open** key menu. Each key in this menu corresponds to the selectable items in the **File Open** dialog box. The menu keys can be used for easy navigation between the selections within the dialog or the standard **Tab** and **Arrow** keys can be used for dialog navigation. When you navigate to this selection, you have already limited the file recall type and

Recall

now you want to specify which file to open.

Instrument S/W Revision Prior to A.02.00

Open

This selection and the **Enter** key when a filename has been selected or specified actually cause the load to occur. **Open** loads the specified or selected file to the previously selected recall type of either **State** or a specific import data type.

Restriction and Notes: Advisory Event "File <file name> recalled" after recall is complete.

Instrument S/W Revision: Prior to A.02.00

File/Folder List

This menu key navigates to the center of the dialog that contains the list of files and folders. Once here you can get information about the file.

Restriction and Notes Pressing this key navigates you to the files and folders list in the center of the dialog.

Key Path **Recall, <various>, Open...**

Instrument S/W Revision Prior to A.02.00

Sort

Pressing this key brings up the Sort menu that allows you a way to sort the files within the File Open scope. Only one sorting type can be selected at a time and the sorting happens immediately.

Remote Command Notes No SCPI command directly controls the sorting.

Key Path **Recall, <various>, Open...**

Instrument S/W Revision Prior to A.02.00

By Date This allows you to sort the list of files within the scope of the File Open dialog in ascending or descending data order. The date is the last data modified.

Restriction and Notes Files in File Open dialog are sorted immediately in the selected order

Key Path **Recall, <various>, Open..., Sort**

Instrument S/W Revision Prior to A.02.00

By Name This allows you to sort the list of files within the scope of the File Open dialog in ascending or descending order based on the filename.

Restriction and Notes Files in File Open dialog are sorted immediately in the selected order

Key Path	Recall, <various>, Open..., Sort
Instrument S/W Revision	Prior to A.02.00

By Extension This allows you to sort the list of files within the scope of the File Open dialog in ascending or descending order based on the file extension for each file.

Restriction and Notes	Files in File Open dialog are sorted immediately in the selected order
Key Path	Recall, <various>, Open..., Sort
Instrument S/W Revision	Prior to A.02.00

By Size This allows you to sort the list of files within the scope of the File Open dialog in ascending or descending order based on file size.

Restriction and Notes	Files in File Open dialog are sorted immediately in the selected order
Key Path	Recall, <various>, Open..., Sort
Instrument S/W Revision	Prior to A.02.00

Ascending This causes the display of the file list to be sorted, according to the sort criteria above, in Ascending order.

Restriction and Notes	Files in File Open dialog are sorted immediately in the selected order
Key Path	Recall, <various>, Open..., Sort
Instrument S/W Revision	Prior to A.02.00

Descending This causes the display of the file list to be sorted, according to the sort criteria above, in Descending order.

Restriction and Notes	Files in File Open dialog are sorted immediately in the selected order
Key Path	Recall, <various>, Open..., Sort
Instrument S/W Revision	Prior to A.02.00

Files Of Type

This menu key corresponds to the Files Of Type selection in the dialog. It follows the standard Windows supported Files Of Type behavior. It shows the current file suffix that corresponds to the type of file you have selected to save. If you navigated here from recalling State, "State File (*.state)" is in the dialog selection and is the only type available in the pull down menu. If you navigated here from recalling Trace, "Trace+State File (*.trace)" is in the dialog selection and is the only type available under the pull down menu.

Recall

If you navigated here from importing a data file, the data types available will be dependent on the current measurement and the selection you made under “Import Data”. For example:

Amplitude Corrections: pull down menu shows

Amplitude Corrections (*.csv)
Legacy Cable Corrections (*.cbl)
Legacy User Corrections (*.amp)
Legacy Other Corrections (*.oth)
Legacy Antenna Corrections (*.ant)

Limit: pull down menu shows

Limit Data (*.csv)
Legacy Limit Data (*.lim)

Trace: pull down menu shows "Trace Data (*.csv)"

Restriction and Notes	Pressing this key causes the pull down menu to list all possible file types available in this context.
-----------------------	--

Key Path	Recall, <various>, Open...
----------	---

Instrument S/W Revision	Prior to A.02.00
-------------------------	------------------

Up One Level

This menu key corresponds to the icon of a folder with the up arrow that is in the tool bar of the dialog. It follows the standard Windows supported Up One Level behavior. When pressed, it causes the file and folder list to navigate up one level in the directory structure.

Restriction and Notes	When pressed, the file and folder list is directed up one level of folders and the new list of files and folders is displayed.
-----------------------	--

Key Path	Recall, <various>, Open...
----------	---

Instrument S/W Revision	Prior to A.02.00
-------------------------	------------------

Cancel

This menu key corresponds to the Cancel selection in the dialog. It causes the current File Open request to be cancelled. It follows the standard Windows supported Cancel behavior.

Restriction and Notes	Pressing this key causes the Open dialog to go away and auto return.
-----------------------	--

Key Path	Recall, <various>, Open...
----------	---

Instrument S/W Revision	Prior to A.02.00
-------------------------	------------------

Restart

The Restart function restarts the current sweep, or measurement, or set of averaged/hold sweeps or measurements. If you are Paused, pressing Restart does a Resume.

The Restart function is accessed in several ways:

- Pressing the Restart key
- Sending the remote command INIT:IMMEDIATE
- Sending the remote command INIT:RESTART

Remote Command:	:INITiate[:IMMEDIATE]
Example:	:INIT:IMM
Dependencies/Couplings:	Resets average/hold count k. For the first sweep overwrites all active (update=on) traces with new current data. For application modes, it resets other parameters as required by the measurement.
Remote Command Notes:	:INITiate:RESTART :INITiate:IMMEDIATE Either of the above commands perform exactly the same function.
SCPI Status Bits/OPC Dependencies:	This is an Overlapped command. The STATUS:OPERation register bits 0 through 8 are cleared. The STATUS:QUESTIONable register bit 9 (INTEGRITY sum) is cleared. The SWEEPING bit is set. The MEASURING bit is set.
Instrument S/W Revision:	Prior to A.02.00
Remote Command:	:INITiate:RESTART
Example:	:INIT:REST
Dependencies/Couplings:	Resets average/hold count k. For the first sweep overwrites all active (update=on) traces with new current data. For application modes, it resets other parameters as required by the measurement.
Remote Command Notes:	:INITiate:RESTART :INITiate:IMMEDIATE Either of the above commands perform exactly the same function.

Restart

SCPI Status Bits/OPC Dependencies:	This is an Overlapped command. The STATUS:OPERation register bits 0 through 8 are cleared. The STATUS:QUEStionable register bit 9 (INTEgrity sum) is cleared. The SWEEPING bit is set. The MEASURING bit is set.
Instrument S/W Revision:	Prior to A.02.00

The **Restart** function first aborts the current sweep/measurement as quickly as possible. It then resets the sweep and trigger systems, sets up the measurement and initiates a new data measurement sequence with a new data acquisition (sweep) taken once the trigger condition is met.

If the analyzer is in the process of aligning when **Restart** is executed, the alignment finishes before the restart function is performed.

Even when set for Single operation, multiple sweeps may be taken when Restart is pressed (for example, when averaging/holding is on). Thus when we say that **Restart** "restarts a measurement," we may mean:

- It restarts the current sweep
- It restarts the current measurement
- It restarts the current set of sweeps if any trace is in Trace Average, Max Hold or Min Hold
- It restarts the current set of measurements if Averaging, or Max Hold, or Min Hold is on for the measurement
- depending on the current settings.

With **Average/Hold Number** (in **Meas Setup** menu) set to 1, or Averaging off, or no trace in Trace Average or Hold, a single sweep is equivalent to a single measurement. A single sweep is taken after the trigger condition is met; and the analyzer stops sweeping once that sweep has completed. However, with **Average/Hold Number** >1 and at least one trace set to **Trace Average, Max Hold, or Min Hold (SA Measurement)** or **Averaging on (most other measurements)**, multiple sweeps/data acquisitions are taken for a single measurement. The trigger condition must be met prior to each sweep. The sweep is stopped when the average count k equals the number N set for **Average/Hold Number**. A measurement average usually applies to all traces, marker results, and numeric results; but sometimes it only applies to the numeric results.

Once the full set of sweeps has been taken, the analyzer will go to idle state. To take one more sweep without resetting the average count, increment the average count by 1, by pressing the step up key while **Average/Hold Number** is the active function, or sending the remote command CALC:AVER:TCON UP.

Save

Save functionality is common across multiple Modes and Measurements. These common features are described in this section.

The Save feature prompts you to essentially answer the questions: What do you want to save? And where do you want to save it? Once these questions are answered the save can occur. The options in this menu answer the question, "What do you want to save?"

Accesses a menu that provides the save type options. The **Save Type** options are **State**, **Trace**, **Data**, or a **Screen Image** depending on the active mode.

Remote Command Notes	No remote command for this key specifically.
Key Path	Save
Mode	All
Instrument S/W Revision	Prior to A.02.00

State

Selects **State** as the save type and accesses a menu that provides the options of where to save. You can save either to a register or a file. This menu key will not actually cause the save until the location is chosen.

Saving the state is the only way to save this exact measurement context for the current active mode. The entire state of the active mode is saved in a way that when a recall is requested, the mode will return to as close as possible the context in which the save occurred. This includes all settings and data for only the current active mode.

It should be noted that the Input/Output settings will be saved when saving State, since these settings plus the state of the mode best characterize the current context of the mode, but the mode independent System settings will not be saved.

This key will not actually cause the save, since the save feature still needs to know where to save the state. Pressing this key will bring up the Save State menu that provides you with these options.

For rapid saving, the State menu lists registers to save to, or you can select a file to save to. Once they pick the destination of the save in the State menu, the save will occur.

Example	MMEM:STOR:STATe "MyStateFile.state" This stores the current instrument state data in the file MyStateFile.state in the default directory.
Remote Command Notes	See "Save" on page 1209 .
Key Path	Save
Mode	All
Instrument S/W Revision	Prior to A.02.00

Save

Register 1 thru Register 6

Selecting any one of these register menu keys causes the State of the currently active mode to be saved to the specified Register. The registers are provided for rapid saving and recalling, since you do not need to specify a filename or navigate to a file. Each of the register menu keys annotates whether it is empty or at what date and time it was last modified.

These 6 registers are all that is available from the front panel for all modes in the instrument. There are not 6 registers available for each mode. From remote, 127 Registers are available. Registers are files that are visible to you in the My Documents\System folder.

Example	*SAV 1
Key Path	Save, State
Mode	All
Readback	Date and time with seconds resolution are displayed on the key, or "(empty)" if no prior save operation performed to this register.
Instrument S/W Revision	Prior to A.02.00
Example	*SAV 2
Key Path	Save, State
Mode	All
Readback	Date and time with seconds resolution are displayed on the key, or "(empty)" if no prior save operation performed to this register.
Instrument S/W Revision	Prior to A.02.00
Example	*SAV 3
Key Path	Save, State
Mode	All
Readback	Date and time with seconds resolution are displayed on the key, or "(empty)" if no prior save operation performed to this register.
Instrument S/W Revision	Prior to A.02.00
Example	*SAV 4
Key Path	Save, State
Mode	All
Readback	Date and time with seconds resolution are displayed on the key, or "(empty)" if no prior save operation performed to this register.
Instrument S/W Revision	Prior to A.02.00

Example	*SAV 5
Key Path	Save, State
Mode	All
Readback	Date and time with seconds resolution are displayed on the key, or "(empty)" if no prior save operation performed to this register.
Instrument S/W Revision	Prior to A.02.00

Example	*SAV 6
Key Path	Save, State
Mode	All
Readback	Date and time with seconds resolution are displayed on the key, or "(empty)" if no prior save operation performed to this register.
Instrument S/W Revision	Prior to A.02.00

To File . . .

Accesses a menu that enables you to select the location for saving the State. This menu is similar to a standard Windows® **Save As** dialog.

The default path for all State Files is:

My Documents\<<mode name>\state

where <mode name> is the parameter used to select the mode with the INST:SEL command (for example, SA for the Spectrum Analyzer). This path is the **Save In:** path in the **Save As** dialog for all State Files when they first enter this dialog.

Key Path	Save, State
Mode	All
Instrument S/W Revision	Prior to A.02.00

Save As . . .

This menu lets you select the location where you can save the State. This menu is a standard Windows® dialog with Save As menu keys. The "File Name" field in the Save As dialog is initially loaded with an automatically generated filename specific to the appropriate Save Type. The automatically generated filename is guaranteed not to conflict with any filename currently in the directory. You may replace or modify this filename using the File Name key. See the Quick Save key documentation for more on the automatic file naming algorithm.

The default path for all State Files is:

My Documents\<<mode name>\state

where <mode name> is the parameter used to select the mode with the INST:SEL command (for example, SA for the Spectrum Analyzer).

Save

When you first enter this dialog, the path in the **Save In:** field depends on the data type. The only files that are visible are the *.state files and the Save As type is *.state, since .state is the file suffix for the State Save Type.

Key Path	Save, State
Mode	All
Instrument S/W Revision	Prior to A.02.00

Save Saves all of the State of the currently active mode plus the system level Input/Output settings to the specified file.

While the save is being performed, the floppy icon shows up in the settings bar near the Continuous/Single sweep icon. After the save completes, the Advisory Event "File <register number> saved" is displayed.

Remote Command	:MMEMoRY:STORe:STATe <filename>
Example	:MMEM:STOR:STAT "myState.state" saves the file myState.state on the default path
Restriction and Notes	If the file already exists, the file will be overwritten. Using the C: drive is strongly discouraged, since it runs the risk of being overwritten during a instrument software upgrade. Both single and double quotes are supported for any filename parameter over remote. Auto return to the State menu and the Save As dialog goes away.

Key Path	Save, State, To File...
Mode	All
Instrument S/W Revision	Prior to A.02.00

Trace (+State)

Selects a state file which includes trace data for recalling as the save type and accesses a menu that enables you to select which trace to save. You can save to either a register or a file. Not all modes support saving trace data with the state; and for modes that do, not all measurements do. This key is grayed out for measurements that do not support trace saves. It is blanked for modes that do not support trace saves. Saving **Trace** is identical to saving State except a .trace extension is used on the file instead of .state, and internal flags are set in the file indicating which trace was saved. You may also select to save ALL traces.

This key will not actually cause the save, since the save feature still needs to know which trace to save and where to save it. Pressing this key will bring up the Save Trace menu that provides you with these options.

For rapid saving, the Trace menu lists registers to save to, or you can select a file to save to. Once you

pick the destination of the save in the Trace menu, the save will occur.

Example	MMEM:STOR:STATe TRACE2,"MyTraceFile.trace" This stores trace 2 data in the file MyTraceFile.trace in the default directory. :MMEM:STOR:TRAC:REG TRACE1,2 stores trace 1 data in trace register 2 :MMEM:STOR:TRAC:REG ALL,3 saves the data for all 6 traces in trace register 3
Remote Command Notes	See "Save" on page 1209 .
Key Path	Save
Mode	SA
Instrument S/W Revision	Prior to A.02.00

Register 1 thru Register 5

Selecting any one of these register menu keys causes the Trace(s) specified under From Trace, along with the state of the currently active mode, to be saved to the specified Trace Register. The registers are provided for rapid saving and recalling, since you do not need to specify a filename or navigate to a file. Each of the register menu keys annotates whether it is empty or at what date and time it was last modified.

These 5 trace registers are all that is available for all modes in the instrument. At present, only the Swept SA measurement of the Spectrum Analyzer mode supports saving to Trace+State files. Registers are files that are visible to you in the My Documents\System folder.

Key Path	Save, Trace
Mode	SA
Readback	Date and time with seconds resolution are displayed on the key, or "(empty)" if no prior save operation performed to this register.
Instrument S/W Revision	Prior to A.02.00
Key Path	Save, Trace
Mode	SA
Readback	Date and time with seconds resolution are displayed on the key, or "(empty)" if no prior save operation performed to this register.
Instrument S/W Revision	Prior to A.02.00
Key Path	Save, Trace
Mode	SA

Save

Readback	Date and time with seconds resolution are displayed on the key, or "(empty)" if no prior save operation performed to this register.
Instrument S/W Revision	Prior to A.02.00
Key Path	Save, Trace
Mode	SA
Readback	Date and time with seconds resolution are displayed on the key, or "(empty)" if no prior save operation performed to this register.
Instrument S/W Revision	Prior to A.02.00
Key Path	Save, Trace
Mode	SA
Readback	Date and time with seconds resolution are displayed on the key, or "(empty)" if no prior save operation performed to this register.
Instrument S/W Revision	Prior to A.02.00

From Trace

Accesses a menu that enables you to select the trace to be saved. You can choose either 1, 2, 3, 4, 5, 6 or All. Not all modes have the full six traces. Once a trace is selected, the key returns back to the Save Trace menu and the selected trace number is annotated on the key. The default is the currently selected trace, selected in this menu or in the Trace/Det, Export Data, Import Data or Recall Trace menus, except if you have chosen All then it remains chosen until you specifically change it to a single trace. To save the Trace you must select **Save As**.

These keys let you pick which trace to save. Now you have selected exactly what needs to be saved. In order to trigger a save of the selected **Trace**, you must select the **Save As** key in the Save Trace menu.

Key Path	Save, Trace + State
Mode	SA
Instrument S/W Revision	Prior to A.02.00

Save As . . .

This menu lets you select the location where you can save the Trace. It is a standard Windows® dialog with Save As menu keys.

The "File Name" field in the Save As dialog is initially loaded with an automatically generated filename specific to the appropriate Save Type. The automatically generated filename is guaranteed not to conflict with any filename currently in the directory. You may replace or modify this filename using the File Name key. See the Quick Save key documentation for more on the automatic file naming algorithm.

The default path for all State Files including .trace files is:

My Documents\<<mode name>\state

where <mode name> is the parameter used to select the mode with the INST:SEL command (for example, SA for the Spectrum Analyzer).

When you first enter this dialog, the path in the Save In: field depends on the data type. The only files that are visible are the *.trace files and the Save As type is *.trace, since .trace is the file suffix for the Trace Save Type.

Restriction and Notes	Brings up Save As dialog for saving a Trace Save Type
Key Path	Save, Trace (+State)
Mode	SA
Instrument S/W Revision	Prior to A.02.00

Save This key initiates the save of the .trace file. All of the State of the currently active mode plus the system level Input/Output settings are saved to the specified file as well as all of the trace data, including internal flags set in the file indicating which trace is to be saved.

While the save is being performed, the floppy icon shows up in the settings bar near the Continuous/Single sweep icon. After the save completes, the Advisory Event "File <register number> saved" is displayed.

Remote Command	<pre>:MMEMory:STORe:TRACe TRACE1 TRACE2 TRACE3 TRACE4 TRACE5 TRACE6 ALL, <filename> > :MMEMory:STORe:TRACe:REGister TRACE1 TRACE2 TRACE3 TRACE4 TRACE5 TRACE6 ALL, <integer></pre>
Example	<pre>:MMEM:STOR:TRAC TRACE1,"myState.trace" saves the file myState.trace on the default path and flags it as a "single trace" file with Trace 1 as the single trace (even though all of the traces are in fact stored). :MMEM:STOR:TRAC ALL,"myState.trace" saves the file myState.trace on the default path and flags it as an "all traces" file :MMEM:STOR:TRAC:REG TRACE1,2 stores trace 1 data in trace register 2</pre>
Remote Command Notes	<p>Some modes and measurements do not have available all 6 traces. The Phase Noise mode command, for example, is: MMEMory:STORe:TRACe TRACE1 TRACE2 TRACE3 ALL,<filename></p> <p>This command actually performs a save state, which in the Swept SA measurement includes the trace data. However it flags it (in the file) as a "save trace" file of the specified trace (or all traces).</p> <p>The range for the register parameter is 1–5</p>
Restriction and Notes	<p>If the file already exists, the file will be overwritten. Using the C: drive is strongly discouraged, since it runs the risk of being overwritten during a instrument software upgrade. Both single and double quotes are supported for any filename parameter over remote.</p> <p>Auto return to the State menu and the Save As dialog goes away.</p>
Key Path	Save, Trace, Save As...

Save

Mode	SA
Instrument S/W Revision	Prior to A.02.00

Data (Mode Specific)

Exporting a data file stores data from the current measurement to mass storage files. The Export Menu only contains data types that are supported by the current measurement.

For any given mode, the Export Data and Import Data menus match, but keys in Import Data are blanked if the data type is supported for Save but not for Recall.

Since the commonly exported data files are in .csv format, the data can be edited by you prior to importing. This allows you to export a data file, manipulate the data in Excel (the most common PC Application for manipulating .csv files) and then import it.

Selecting an Export Data menu key will not actually cause the exporting to occur, since the analyzer still needs to know where you wish to save the data. Pressing the Save As key in this menu brings up the Save As dialog and Save As menu that allows you to specify the destination file and directory. Once a filename has been selected or entered in the Open menu, the export will occur as soon as the Save key is pressed. See section [“Save As . . .” on page 1225](#) for more details.

Remote Command Notes	No SCPI command directly controls the Data Type that this key controls. The Data Type is included in the MMEM:STORe commands.
Dependencies/Couplings	If a file type is not used by a certain measurement, that type is grayed out for that measurement. The key for a file type will not show if there are no measurements in Mode that supports it.
Key Path	Save
Mode	All
Preset	<mode specific>; Is not affected by Preset, but is reset during Restore Mode Defaults and survives subsequent running of the mode.
Readback	1-of-N selection
Instrument S/W Revision	Prior to A.02.00

Trace

Pressing this key selects Traces as the data type to be exported with this save request. Pressing this key when it is already selected brings up the Trace Menu, which allows you to select which Trace to save. This is the same as the Select Trace menu under Trace. The trace selected on that menu appears selected here, and selecting a trace here causes the same trace to be selected on the Select Trace menu. (That is, there is only one "selected trace".) This key is grayed out when measurements are running that do not

support trace exporting.

Example	MMEM:STOR:TRAC:DATA TRACE3,"MyTraceFile.csv" This stores the specified trace data in the file MyTraceFile.csv in the default directory. VSA Example: MMEM:STOR:TRAC:DATA TRACE1,"Trc1.txt",TXT,ON
Remote Command Notes	See
Dependencies/Couplings	Trace data is not available from all Measurements. In that case, the key will be grayed out. The key will not show if no measurements in the Mode support it. For SA measurements, traces cannot be recalled from a trace file that was saved with ALL traces selected.
Key Path	Save, Data
Mode	SA Analog Demod VSA
Preset	Not part of Preset, but is reset by Restore Mode Defaults and survives power cycles.
State Saved	Saved in State
Readback	selected Trace table
Readback	Swept SA: 1 2 3 4 5 6 ALL Analog Demod Mode: RF Spectrum Demod Demod Ave Demod Max Demod Min AF Spectrum Vector Signal Analyzer: Trace 1 Trace 2 with header Trace 2 Trace 2 with header Trace 3 Trace 3 with header Trace 4 Trace 4 with header Trace 5 Trace 5 with header Trace 6 Trace 6 with header
Instrument S/W Revision	Prior to A.02.00

Trace selection These keys let you pick which Trace to save. The traces may have names, or they may be labeled 1, 2, 3, 4, 5, or 6, depending on the current mode. Once selected, the key returns back to the Export Data menu and the selected trace name/number is annotated on the key. The default is the currently selected trace, selected in this menu or in the Trace/Det, Import Data, Recall Trace or Save Trace menus, except if you have chosen All then it remains chosen until you specifically change it to a single trace.

In order to trigger a save of the selected trace, you must select the Save As key in the Export Data menu.

Some measurements have an "ALL" selection. This saves all six traces in one .csv file with the x-axis data in the first column and the individual trace data in succeeding columns. The header data and x-axis data in this file reflect the current settings of the measurement. Note that any traces which are in View or Blank may have different x-axis data than the current measurement settings; but this data will not be

Save

output to the file.

Key Path	Save, Data, Trace
Mode	SA Analog Demod VSA
Preset	The first trace key shown.
Instrument S/W Revision	Prior to A.02.00

Include Header The trace header information includes enough state information to display the trace data with the same formatting and scaling when it is recalled. However, no other instrument state information is saved. If headers are not saved, the scaling and format are set to defaults when the trace is recalled.

Example	MMEM:STOR:TRAC:DATA TRACE1,"Trc1.txt",TXT,ON The On/Off setting is the last variable passed in the MMEMory:STORe:TRACe:DATA command.
---------	---

Key Path	Save, Data, Trace
Mode	VSA
Preset	On
Instrument S/W Revision	Prior to A.02.00

Measurement Results

Different types of results are available for each particular measurement. The results that are available are documented under the individual measurements. These measurement results are the same as the results that are returned when using the MEASure:<measurement> command (usually for sub-opcode 1).

Measurement results may not be available for all measurements.

Example	MMEM:STOR:RES "MyResultsFile.xml" This stores the measurement results data in the file MyResultsFile.xml in the default directory.
Remote Command Notes	See “Save” on page 1216
Dependencies/Couplings	The key will not show if no measurements in the Mode support it.
Key Path	Save, Data
Mode	SA ADEMOD BASIC(IQ Analyzer) CDMA2K GSMEDGE PNOISE WCDMA WIMAXOFDMA TDS CDMA
Instrument S/W Revision	Prior to A.02.00

Amplitude Correction

Pressing this key selects the **Amplitude Corrections** as the data type to be exported with this save request. This key brings up the Amplitude Correction Menu that allows you to select which **Amplitude**

Correction to save.

Example:	MMEM:STOR:CORR 3,"MyCorrectionsFile.csv"
	This stores the specified corrections data (3) in the file MyCorrectionsFile.csv in the default directory.
Remote Command Notes:	See
Key Path:	Save, Data
Preset:	1; Is not part of Preset, but is reset by Restore Input/Output Defaults and survives subsequent running of the mode
State Saved:	Saved in instrument state.
Readback:	1 2 3 4
Dependencies/Couplings:	The key will not show if no measurements in the Mode support it.
Instrument S/W Revision:	A.02.00

Amplitude Correction 1, 2, 3, 4 These menu key selections let you pick which Amplitude Correction to save; either 1, 2, 3, or 4. The default is **1**. Once selected, the key returns back to the **Export Data** menu and the selected Amplitude Correction number is annotated on the key. Now exactly what needs to be saved has been selected. In order to trigger a save of the selected **Amplitude Correction**, you must select the **Save As** key in the **Export Data** menu.

An example of using this menu is: if you select 4, the Amplitude Correction table 4 will be saved to the file selected or entered in File Name option in the Save As dialog. See [“Save As . . .” on page 1225](#) for more details.

Key Path	Save, Data, Amplitude Correction
Readback	1
Instrument S/W Revision	A.02.00

Key Path	Save, Data, Amplitude Correction
Readback	2
Instrument S/W Revision	A.02.00

Key Path	Save, Data, Amplitude Correction
Readback	3
Instrument S/W Revision	A.02.00

Key Path	Save, Data, Amplitude Correction
Readback	4
Instrument S/W Revision	A.02.00

Save

Limit Line

Pressing this key selects the Limit Lines as the data type to be exported with this save request. This key brings up the Limit Line Menu that allows you to select which **Limit Line** to save. This key is grayed out when SA measurements are running that do not support limit line exporting.

Example:	MMEM:STOR:LIM LLINE1,"MyLimitsFile.csv" This stores the specified limit line data in the file MyLimitsFile.csv in the default directory.
Remote Command Notes:	See
Dependencies/Couplings:	Some Measurements do not allow the use of limit lines, so the key will be grayed out. The key will not show if no measurements in the Mode support it.
Preset:	1; not part of Preset, but is reset by Restore Mode Defaults and survives power cycles
State Saved:	Saved in State
Key Path:	Save, Data
Readback:	selected Limit Line
Readback:	1 2 3 4 5 6
Instrument S/W Revision:	A.02.00

Limit Line 1, 2, 3, 4, 5, 6 These keys let you pick which Limit Line to save. The default is **1**. Once selected, the key returns back to the **Export Data** menu and the selected Limit Line number is annotated on the key. Now you have selected exactly what needs to be saved. To trigger a save of the selected Limit Line, you must select the Save As key in the Export Data menu.

An example of using this menu is: If you select 2, the Limit Line 2 will be saved in the format described in Section Limit Line Data File to the file selected or entered in **File Name** option in the **Save As** dialog.

Key Path	Save, Data, Limit Line
Instrument S/W Revision	A.02.00

Capture Buffer

Capture Buffer functionality is not available for all measurements. The captured data is raw data (unprocessed).

Example	MMEM:STOR:CAPT "MyCaptureData.bin" This stores the capture data in the file MyCaptureData.bin in the default directory.
Remote Command Notes	See "Save" on page 1216
Dependencies/Couplings	The key will not show if no measurements in the Mode support it.

Key Path	Save, Data
Mode	WCDMA
Instrument S/W Revision	Prior to A.02.00

Zone map

A map file contains zone definitions that will help simplify making measurements of frequently used signals. The OFDMA frame structure can contain multiple-zone definitions for the uplink and downlink subframes and multiple data burst allocations. You can store map files in which you have saved complicated OFDMA frame analysis zone definitions. This can save you time and ensure the accuracy of repeated measurements. map files are also useful for recreating measurement settings so they can be used by other users.

Example	MMEM:STOR:ZMAP "MyZonemapFile.omf" This stores the zone map data in the file MyZonemapFile.omf in the default directory.
Remote Command Notes	See "Save" on page 1216
Dependencies/Couplings	The key will not show if no measurements in the Mode support it.
Key Path	Save, Data
Mode	OFDMA WiMAX
Instrument S/W Revision	Prior to A.02.00

Recorded Data

Saving recorded data is not available for all measurements. Recorded data, and the optional header info, may be recalled later (or transferred to another instrument) for analysis.

This function is available in 89601X VSA Option 200, but not in Option 205.

Example	MMEM:STOR:REC "MyRecording.sdf",SDF,ON,ON,OFF
Restriction and Notes	Grayed out unless there is recorded data in the buffer.
Key Path	Save, Data (Export)
Mode	VSA
Instrument S/W Revision	Prior to A.02.00

Save As . . .

This menu lets you select the location where you can save Data Type files. It is a standard Windows® dialog with Save As menu keys. The "File Name" field in the Save As dialog is initially loaded with an automatically generated filename specific to the appropriate Save Type. The automatically generated filename is guaranteed not to conflict with any filename currently in the directory. You may replace or modify this filename using the File Name key. See the Quick Save key documentation for more on the

Save

automatic file naming algorithm.

When you first enter this dialog, the path in the Save In: field depends on the data type. The only files that are visible are the files with the corresponding data type suffix, and the **Save As** type lists the same suffix.

For example, if the Data Type is **Amplitude Corrections**, the file suffix is .csv and the *.csv files are the only visible files in the **Save As** dialog and .csv is the Save As Type.

The default path for saving files is:

For all of the Trace Data Files:

My Documents\<<mode name>\data\traces

For all of the Limit Data Files:

My Documents\<<mode name>\data\limits

For all of the Measurement Results Data Files:

My Documents\<<mode name>\data\<<measurement name>\results

For all of the Capture Buffer Data Files:

My Documents\<<mode name>\data\captureBuffer

Restriction and Notes	Brings up Save As dialog for saving a <mode specific> Save Type
Key Path	Save, Data
Mode	All
Instrument S/W Revision	Prior to A.02.00

Save Saves the specified Data Type. This section describes any specific save behavior relevant to Data that is common to all modes.

When a Save of a specific Data File is requested, the specified data is saved to the specified or selected file. The save is performed immediately and does not wait until the measurement is complete.

If the file already exists, a dialog will popup that allows you to replace the existing file by selecting an **OK** or you can **Cancel** the request.

While the save is being performed, the floppy icon will show up in the settings bar near the Continuous/Single icon. After a register save completes, the corresponding register key annotation is updated with the date the time and an advisory message that the file was saved appears in the message

bar.

Restriction and Notes If the file already exists, the file will be overwritten. Using the C: drive is strongly discouraged, since it runs the risk of being overwritten during a instrument software upgrade. Both single and double quotes are supported for any filename parameter over remote.

Key Path **Save, Data, Save As...**

Instrument S/W Revision Prior to A.02.00

Remote Command `:MMEMory:STORe:RESults <filename>`

Example `:MMEM:STOR:RES "myResults.csv"` saves the results from the current measurement to the file myResults.csv in the default path.

`:MMEM:STOR:RES`

`"MyDocuments\Basic\data\ComplexSpectrum\results\myResults.xml"` saves the results from the current measurement (Complex Spectrum) to the file myResults.xml in the default path for IQ Analyzer (Basic) Mode.

This command form is not supported for the Swept SA measurement; see below.

Mode SA|ADEMOD|BASIC(IQ Analyzer)|CDMA2K|GSMEDGE|
PNOISE|WCDMA|WIMAXOFDMA|
TDSCDMA

Instrument S/W Revision Prior to A.02.00

Remote Command `:MMEMory:STORe:RESults:MTABle|PTABle <filename>`

Example `:MMEM:STOR:RES:MTAB "myResults.csv"` saves the results from the current marker table to the file myResults.csv in the default path.

`:MMEM:STOR:RES:PTAB "myResults.csv"` saves the results from the current peak table to the file myResults.csv in the default path.

This command form is only supported for the Swept SA measurement; see above.

Dependencies/Couplings If a save of Marker Table results is requested and the Marker Table is not on, no file is saved an error is generated:

Mass Storage error; Mkr Table must be on to save Mkr Table as Meas Results

If a save of Peak Table results is requested and the Peak Table is not on, no file is saved an error is generated:

Mass Storage error; Pk Table must be on to save Pk Table as Meas Results

Mode SA

Save

Preset	Peak Table
State Saved	Saved in State
Range	Peak Table Marker Table
Instrument S/W Revision	Prior to A.02.00

Remote Command :MMEMory:STORe:CORRection 1|2|3|4, <filename>

Example :MMEM:STOR:CORR 2 "myAmpcor.csv" saves just the 2nd Amplitude Correction table to the file myAmpcor.csv on the default path.

Mode	SA
Instrument S/W Revision	A.02.00

Remote Command :MMEMory:STORe:TRACe:DATA
TRACE1|TRACE2|TRACE3|TRACE4|TRACE5|TRACE6|ALL, <filename
>

Example :MMEM:STOR:TRAC:DATA TRACE2,"myTrace2.csv" exports the 2nd trace to the file myTrace2.csv in the default path.

Remote Command Notes Not all measurements have the ALL selection. Traces cannot be recalled from files that were saved using the ALL selection.

If the save is initiated via SCPI, and the file already exists, the file will be overwritten.

Using the C: drive is strongly discouraged, since it runs the risk of being overwritten during an instrument software upgrade. Both single and double quotes are supported for any filename parameter over remote.

Mode	SA Analog Demod
Instrument S/W Revision	Prior to A.02.00

Trace Number	Analog Demod Mode: Trace Names
TRACE1	RF Spectrum
TRACE2	Demod
TRACE3	Demod Ave
TRACE4	Demod Max
TRACE5	Demod Min
TRACE6	AF Spectrum

Remote Command	<code>:MMEMory:STORe:TRACe:DATA TRACE1 TRACE2 TRACE3 TRACE4 TRACE5 TRACE6 , "<filename>" [, CSV TXT SDF [, OFF ON 0 1]]</code>
Example	<code>MMEM:STOR:TRAC:DATA TRACE1,"Trc1.txt",TXT,ON</code>
Restriction and Notes	<p>If you are not licensed to save a particular file type, then an error will be returned. If an invalid file format is specified or the file cannot be saved successfully, then an error is returned.</p> <p>8901X Option 205 allows export in TXT, CSV, and SDF formats.</p> <p>8901X Option 200 allows the Option 205 formats and additionally: Matlab 4, 5 and HDF5, and an N5110A compatible binary format.</p>
Remote Command Notes	<p>File format is selected by the second parameter, but no default extension is appended to the filename. If the second parameter is not supplied, then the filename extension is used to determine the format. *.mat selects Matlab 5 format. *.sdf, or an unrecognized extension chooses the SDF fast format.</p> <p>The optional Boolean determines if the file is saved with headers. By default the headers are saved.</p>
Mode	VSA
Instrument S/W Revision	Prior to A.02.00
Remote Command	<code>:MMEMory:STORe:LIMit LLINE1 LLINE2 , <filename></code>
Example	<code>:MMEM:STOR:LIM LLINE2,"myLimitLine2.csv" saves the 2nd Limit Line to the file myLimitLine2.csv in the default path.</code>
Remote Command Notes	<p>If the save is initiated via SCPI, and the file already exists, the file will be overwritten.</p> <p>Using the C: drive is strongly discouraged, since it runs the risk of being overwritten during an instrument software upgrade. Both single and double quotes are supported for any filename parameter over remote.</p>
SCPI Status Bits/OPC Dependencies	Sequential - waits for previous measurement to complete
Key Path	Save, Data, To File, Save As
Mode	NFIGURE
Instrument S/W Revision	A.02.00
Remote Command	<code>:MMEMory:STORe:CAPTured <filename></code>

Remote Command Notes	<p>Recorded data must be available in the buffer.</p> <p>File format is selected by the second parameter, but no default extension is appended to the filename. If the second parameter is not supplied, then the filename extension is used to determine the format. *.mat selects Matlab 5 format. *.sdf, or an unrecognized extension chooses the SDF fast format.</p> <p>The three optional Booleans determine if:</p> <ol style="list-style-type: none">1. file is saved with headers2. data is resampled to the current span before saving3. player position settings limit the data saved
Mode	VSA
Instrument S/W Revision	Prior to A.02.00

Screen Image

Accesses a menu of functions that enable you to specify a format and location for the saved screen image.

Pressing Screen Image brings up a menu which allows you to specify the color scheme of the Screen Image (Themes) or navigate to the Save As dialog to perform the actual save.

Screen Image files contain an exact representation of the analyzer display. They cannot be loaded back onto the analyzer, but they can be loaded into your PC for use in many popular applications.

The image to be saved is actually captured when the **Save** front-panel key is pressed, and kept in temporary storage to be used if you ask for a Screen Image save. When the Screen Image key is pressed, a "thumbnail" of the captured image is displayed, as shown below:

Save

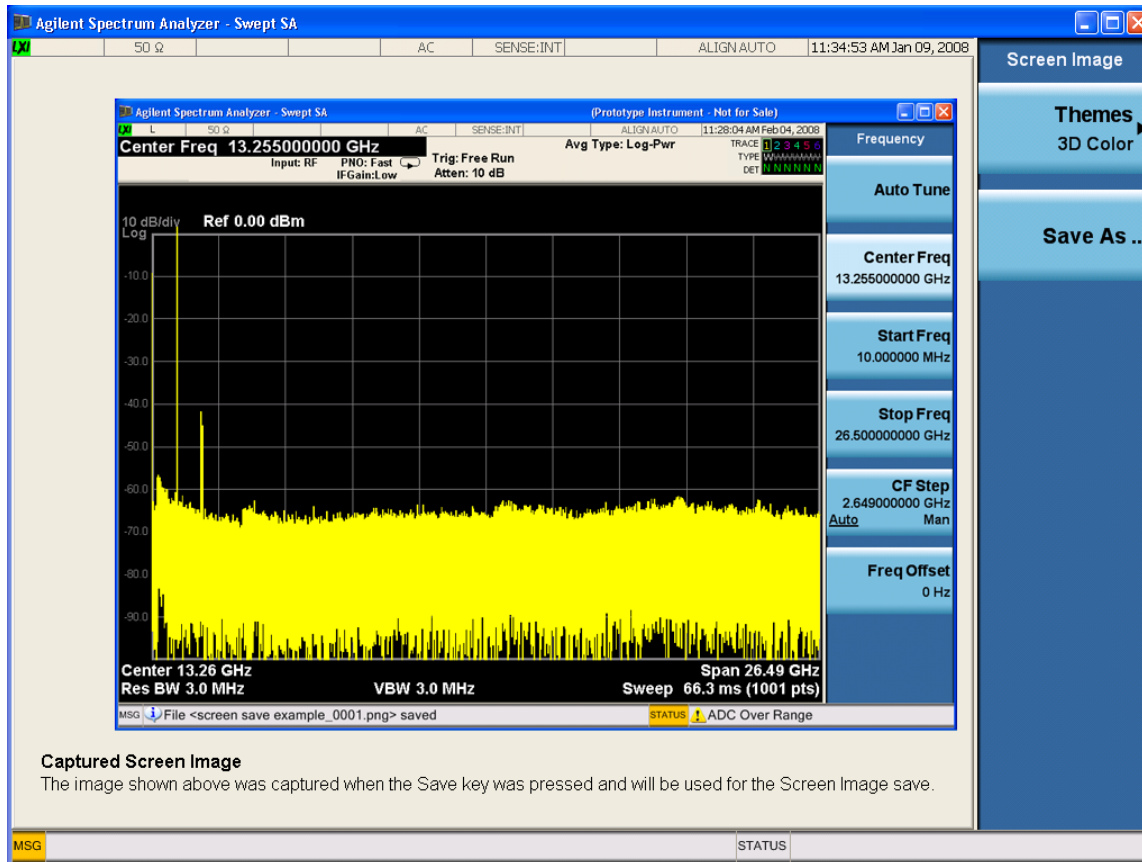

When you continue on into the **Save As** menu and complete the Screen Image save, the image depicted in the thumbnail is the one that gets saved, showing the menus that were on the screen before going into the **Save** menus.

After you have completed the save, the **Quick Save** front-panel key lets you quickly repeat the last save performed, using an auto-named file, with the current screen data.

NOTE For versions previous to A.01.55, if you initiate a screen image save by navigating through the Save menus, the image that is saved will contain the Save menu keys, not the menus and the active function that were on the screen when you first pressed the Save front-panel key.

Example	MMEM:STOR:SCR "MyScreenFile.png"
	This stores the current screen image in the file MyScreenFile.png in the default directory.
Remote Command Notes	See
Key Path	Save
Mode	All

Instrument S/W Revision Prior to A.02.00

Themes

Accesses a menu of function that enable you to choose the theme to be used when saving the screen image.

The **Themes** option is the same as the **Themes** option under the **Display** and **Page Setup** dialogs. It allows you to pick between themes to be used when saving the screen image.

Remote Command	:MMEMory:STORe:SCReem:THEMe TDCoLor TDMonochrome FCoLoR FMONochrome :MMEMory:STORe:SCReem:THEMe?
Example	:MMEM:STOR:SCR:THEM TDM
Key Path	Save, Screen Image
Preset	3D Color; Is not part of Preset, but is reset by Restore Misc Defaults or Restore System Defaults All and survives subsequent running of the modes
Readback	3D Color 3D Mono Flat Color Flat Mono
Instrument S/W Revision	Prior to A.02.00

3D Color Selects a standard color theme with each object filled, shaded and colored as designed.

Example	MMEM:STOR:SCR:THEM TDC
Key Path	Save, Screen Image, Themes
Readback	3D Color
Instrument S/W Revision	Prior to A.02.00

3D Monochrome Selects a format that is like 3D color but shades of gray are used instead of colors.

Example	MMEM:STOR:SCR:THEM TDM
Key Path	Save, Screen Image, Themes
Readback	3D Mono
Instrument S/W Revision	Prior to A.02.00

Flat Color Selects a format that is best when the screen is to be printed on an ink printer.

Example	MMEM:STOR:SCR:THEM FCOL
Key Path	Save, Screen Image, Themes
Readback	Flat Color

Save

Instrument S/W Revision Prior to A.02.00

Flat Monochrome Selects a format that is like Flat Color. But only black is used (no colors, not even gray), and no fill.

Example MMEM:STOR:SCR:THEM FMON

Key Path **Save, Screen Image, Themes**

Readback Flat Mono

Instrument S/W Revision Prior to A.02.00

Save As...

Accesses a menu that enables you to select the location where you can save the Screen Image. This menu is a standard Windows® dialog with Save As menu keys. The **Save As** dialog is loaded with the file information related to the Screen Image Type. The filename is filled in using the auto file naming algorithm for the Screen Image Type and is highlighted. The only files that are visible are the *.png files and the Save As Type is *.png, since .png is the file suffix for the Screen Image Type.

The default path for Screen Images is

My Documents\<<mode name>\screen.

where <mode name> is the parameter used to select the mode with the INST:SEL command (for example, SA for the Spectrum Analyzer).

This path is the **Save In:** path in the **Save As** dialog for all Screen Files when you first enter this dialog.

Restriction and Notes Brings up Save As dialog for saving a Screen Image Save Type

Key Path **Save, Screen Image**

Instrument S/W Revision Prior to A.02.00

Save Saves the screen image to the specified file using the selected theme. The image that is saved is the measurement display prior to when the **Save As** dialog appeared. The save is performed immediately and does not wait until the measurement is complete.

Remote Command: :MMEMory:STORe:SCReen <filename>

Example: :MMEM:STOR:SCR "myScreen.png"

Restriction and Notes: If the file already exists, the file will be overwritten. Using the C: drive is strongly discouraged, since it runs the risk of being overwritten during a instrument software upgrade. Both single and double quotes are supported for any filename parameter over remote.

Auto return to the Screen Image menu and the Save As dialog goes away.

Advisory Event "File <file name> saved" after save is complete.

Key Path: **Save, Screen Image, Save As...**

Instrument S/W Revision: Prior to A.02.00

Save As . . .

The **Save As** is a standard Windows dialog and with the **Save As** key menu. The "File Name" field in the Save As dialog is initially loaded with an automatically generated filename specific to the appropriate Save Type. The automatically generated filename is guaranteed not to conflict with any filename currently in the directory. You may replace or modify this filename using the File Name key. See the Quick Save key documentation for more on the automatic file naming algorithm.

The **Save As** dialog will have the last path loaded in **Save In:** for this particular file type. User specified paths are remembered and persist through subsequent runs of the mode. These remembered paths are mode specific and are reset back to the default using **Restore Mode Defaults**.

Instrument S/W Revision Prior to A.02.00

Save

Performs the actual save to the specified file of the selected type. The act of saving does not affect the currently running measurement and does not require you to be in single measurement mode to request a save. It performs the save as soon as the currently running measurement is in the idle state; when the measurement completes. This ensures the State or Data that is saved includes complete data for the current settings. The save only waits for the measurement to complete when the state or data that depends on the measurement setup is being saved. The save happens immediately when exporting corrections or when saving a screen image.

If the file already exists, a dialog will popup with corresponding menu keys that allows you to replace the existing file with an **OK** or to **Cancel** the request.

While the save is being performed, the floppy icon shows up in the settings bar near the Continuous/Single icon. After the save completes, the corresponding register menu key annotation is updated with the date the time and the message "File <file name> saved" appears in the message bar.

Restriction and Notes: If the file already exists, the File Exist dialog pops up and allows you to replace it or not by selecting the Yes or No menu keys that appear with the dialog. Then the key causes an auto return and Save As dialog goes away.
Advisory Event "File <file name> saved" after save is complete.

Instrument S/W Revision: Prior to A.02.00

File/Folder List

Enables you to navigate to the center of the dialog that contains the list of files and folders. Once here you can get information about the file.

Restriction and Notes Pressing this key navigates you to the files and folders list in the center of the dialog.

Save

Key Path	Save, <various>, Save As...
Instrument S/W Revision	Prior to A.02.00

File Name

Brings up the Alpha Editor as shown in the screen image. Use the knob to choose the letter to add and the Enter front-panel key to add the letter to the file name. In addition to the list of alpha characters, this editor includes a **Space** menu key and a **Done** menu key. The **Done** menu key completes the filename, removes the Alpha Editor and returns back to the **File Open** dialog and menu, but does not cause the save to occur. You can also use **Enter** to complete the file name entry and this will cause the save to occur.

Restriction and Notes	Brings up the Alpha Editor. Editor created file name is loaded in the File name field of the Save As dialog.
Key Path	Save, <various>, Save As...
Instrument S/W Revision	Prior to A.02.00

Save As Type

This key corresponds to the **Save As Type** selection in the dialog. It follows the standard Windows® supported **Save As Type** behavior. It shows the current file suffix that corresponds to the type of file you have selected to save. If you navigated here from saving State, "State File (*.state)" is in the dialog selection and is the only type available under the pull down menu. If you navigated here from saving Trace, "Trace+State File (*.trace)" is in the dialog selection and is the only type available under the pull down menu. If you navigated here from exporting a data file, "Data File (*.csv)" is in the dialog and is available in the pull down menu. Modes can have other data file types and they would also be listed in the pull down menu.

Restriction and Notes	Pressing this key causes the pull down menu to list all possible file types available in this context. All types available are loaded in a 1-of-N menu key for easy navigation.
Key Path	Save, <various>, Save As...
Instrument S/W Revision	Prior to A.02.00

Up One Level

This key corresponds to the icon of a folder with the up arrow that is in the tool bar of the dialog. It follows the standard Windows® supported **Up One Level** behavior. When pressed, it causes the file and folder list to navigate up one level in the directory structure.

Restriction and Notes	When pressed, the file and folder list is directed up one level of folders and the new list of files and folders is displayed
Key Path	Save, <various>, Save As...
Instrument S/W Revision	Prior to A.02.00

Create New Folder

This key corresponds to the icon of a folder with the "*" that is in the tool bar of the dialog. It follows the standard Windows® supported **Create New Folder** behavior. When pressed, a new folder is created in the current directory with the name **New Folder** and allows you to enter a new folder name using the Alpha Editor.

Restriction and Notes	Creates a new folder in the current folder and lets you fill in the folder name using the Alpha Editor.
Key Path	Save, <various>, Save As...
Instrument S/W Revision	Prior to A.02.00

Cancel

This key corresponds to the **Cancel** selection in the dialog. It follows the standard Windows supported **Cancel** behavior. It causes the current **Save As** request to be cancelled.

Restriction and Notes	Pressing this key causes the Save As dialog to go away and auto return.
Key Path	Save, <various>, Save As...
Instrument S/W Revision	Prior to A.02.00

Save

Single (Single Measurement/Sweep)

Single sets the analyzer for Single measurement operation. The single/continuous state is Meas Global, so the setting will affect all the measurements. If you are Paused, pressing **Single** does a Resume.

Example:	:INIT:CONT OFF
Remote Command Notes:	See Cont key description.
Key Path:	Front-panel key
Instrument S/W Revision:	Prior to A.02.00

Single (Single Measurement/Sweep)

Source

This mode does not have any Source control functionality.

Key Path	Front-panel key
Instrument S/W Revision	Prior to A.02.00

Source

SPAN X Scale

Span features are unique to each Measurement. See the specific Measurement for more information.

The front panel key accesses keys to control span (or X-axis) settings.

Key Path	Front-panel key
Instrument S/W Revision	Prior to A.02.00

SPAN X Scale

Sweep / Control

This section describes the keys in the Sweep, Control and Capture menu that are common to multiple Modes and Measurements. See the Measurement descriptions for information on features that are unique.

The Meas Uncal (measurement uncalibrated) warning is given in the Status Bar in the lower right corner of the screen when the manual sweep time entered is too fast to give accurate measurements with the current setting of Res BW. When this happens, increase the Sweep Time or the Res BW.

Key Path	Front-panel key
Instrument S/W Revision	Prior to A.02.00

Abort (Remote Command Only)

This command is used to stop the current measurement. It aborts the current measurement as quickly as possible, resets the sweep and trigger systems, and puts the measurement into an "idle" state. If the analyzer is in the process of aligning when ABORt is sent, the alignment finishes before the abort function is performed. So ABORt does not abort an alignment.

If the analyzer is set for Continuous measurement, it sets up the measurement and initiates a new data measurement sequence with a new data acquisition (sweep) taken once the trigger condition is met.

If the analyzer is set for Single measurement, it remains in the "idle" state until an :INIT:IMM command is received.

Remote Command:	:ABORt
Example:	:ABOR
Dependencies/Couplings:	For continuous measurement, ABORt is equivalent to the Restart key. Not all measurements support the abort command.
Remote Command Notes:	If :INITiate:CONTinuous is ON, then a new continuous measurement will start immediately; with sweep (data acquisition) occurring once the trigger condition has been met. If :INITiate:CONTinuous is OFF, then :INITiate:IMMEDIATE is used to start a single measurement; with sweep (data acquisition) occurring once the trigger condition has been met.
SCPI Status Bits/OPC Dependencies:	The STATus:OPERation register bits 0 through 8 are cleared. The STATus:QUESTionable register bit 9 (INTegrity sum) is cleared. Since all the bits that feed into OPC are cleared by the ABORt, the ABORt will cause the *OPC query to return true.
Instrument S/W Revision:	Prior to A.02.00

Sweep / Control

Pause/Resume

Pauses a measurement after the current data acquisition is complete.

When Paused, the label on the key changes to Resume. Pressing Resume un-pauses the measurement. When you are Paused, pressing **Restart**, **Single** or **Cont** does a Resume.

Remote Command: :INITiate:PAUSE
Dependencies/Couplings: Grayed out in Measurements that don't support Pausing.
Blanked in Modes that don't support Pausing.

Key Path: **Sweep/Control**
Instrument S/W Revision: Prior to A.02.00

Remote Command: :INITiate:RESume
Dependencies/Couplings: Grayed out in Measurements that don't support Pausing.
Blanked in Modes that don't support Pausing.

Key Path: **Sweep/Control**
Instrument S/W Revision: Prior to A.02.00

Gate

The Gate key in the Sweep/Control menu accesses a menu that enables you to control the gating function.

The Gate functionality is used to view signals best viewed by qualifying them with other events. Gate setup parameters are meas global, so the settings will be the same in all the measurements.

Sweep Time autocoupling rules and annotation are changed by Gate being on.

Key Path **Sweep/Control**
Readback The state and method of Gate, as [Off, LO] or [On, Video]. Note that for measurements that only support gated LO, the method is nonetheless read back, but always as LO.
Instrument S/W Revision Prior to A.02.00

Gate On/Off

Turns the gate function on and off.

When the Gate Function is on, the selected Gate Method is used along with the gate settings and the signal at the gate source to control the sweep and video system with the gate signal. Not all measurements allow every type of Gate Methods.

When Gate is on, the annunciation in the Meas Bar reflects that it is on and what method is used, as seen

in the "Gate: LO" annunciator below.

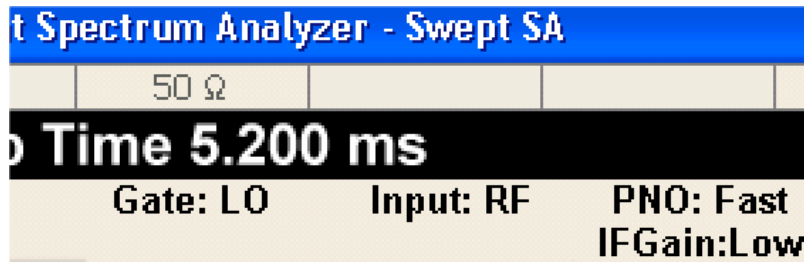

Remote Command:	[:SENSe] :SWEep:EGATe[:STATe] OFF ON 0 1 [:SENSe] :SWEep:EGATe[:STATe] ?
Example:	SWE:EGAT ON SWE:EGAT?
Dependencies/Couplings:	The function is unavailable (grayed out) and Off when: Gate Method is LO or Video and FFT Sweep Type is manually selected. Gate Method is FFT and Swept Sweep Type is manually selected. Marker Count is ON. When Meas Method is RBW or FAST, this function is unavailable and the key is grayed out. Whenever Gate is on, Meas Method, RBW or FAST is unavailable and keys for those are grayed out. When Gate is on, Offset Res BW and Offset Video BW is ignored (if user sets these values) and measurement works like as all Offset Res BW and all Offset Video BW are coupled with Res BW and Video BW under BW menu. When Gate is on, Offset BW key in Offset/Limit menu is grayed out.
Preset:	Off
Range:	On Off
State Saved:	Saved in State
Key Path:	Sweep/Control, Gate
Instrument S/W Revision:	Prior to A.02.00

Gate View On/Off

Turning on Gate View in the Swept SA measurement provides a single-window gate view display.

Turning on Gate View in other measurements shows the split-screen Gate View. In these measurements, when the Gate View is on, the regular view of the current measurement traces and results are reduced vertically to about 70% of the regular height. The Zero Span window showing the positions of the Gate

Sweep / Control

is shown between the Measurement Bar and the reduced measurement window. By reducing the height of the measurement window, some of the annotation on the Data Display may not fit and is not shown.

Remote Command [:SENSe] :SWEep:EGATe:VIEW ON|OFF|1|0
[:SENSe] :SWEep:EGATe:VIEW?

Example SWE:EGAT:VIEW ON turns on the gate view.

Dependencies/Couplings These couplings apply to the Swept SA measurement:

- When Gate View is turned on, the instrument is set to Zero Span.
- Gate View automatically turns off whenever a Span other than Zero is selected.
- Gate View automatically turns off if you press Last Span while in Gate View, and the instrument returns to the Span it was in before entering Gate View (even if that is Zero Span).

When Gate View is turned on, the sweep time used is the gate view sweep time. This is set according to the rules in [“Gate View Sweep Time” on page 1241](#).

- When Gate View is turned off, Sweep Time is set to the normal Swept SA measurement sweep time.
- If Gate View is on and Gate is off, then turning on Gate turns off Gate View.

In the Swept SA measurement:

In Gate View, the regular Sweep Time key is grayed out, to avoid confusing you when you want to set Gate View Sweep Time.

In the other measurements:

When you turn Gate View on, the lower window takes on the current state of the instrument. Upon leaving Gate View, the instrument takes on the state of the lower window.

- When you turn Gate View on, the upper window Sweep Time is set to the gate view sweep time.

Key Path	Sweep/Control, Gate
Preset	OFF
State Saved	Saved in state
Range	On Off
Instrument S/W Revision	Prior to A.02.00

A sample of the Gate View screen in the Swept SA measurement is shown below:

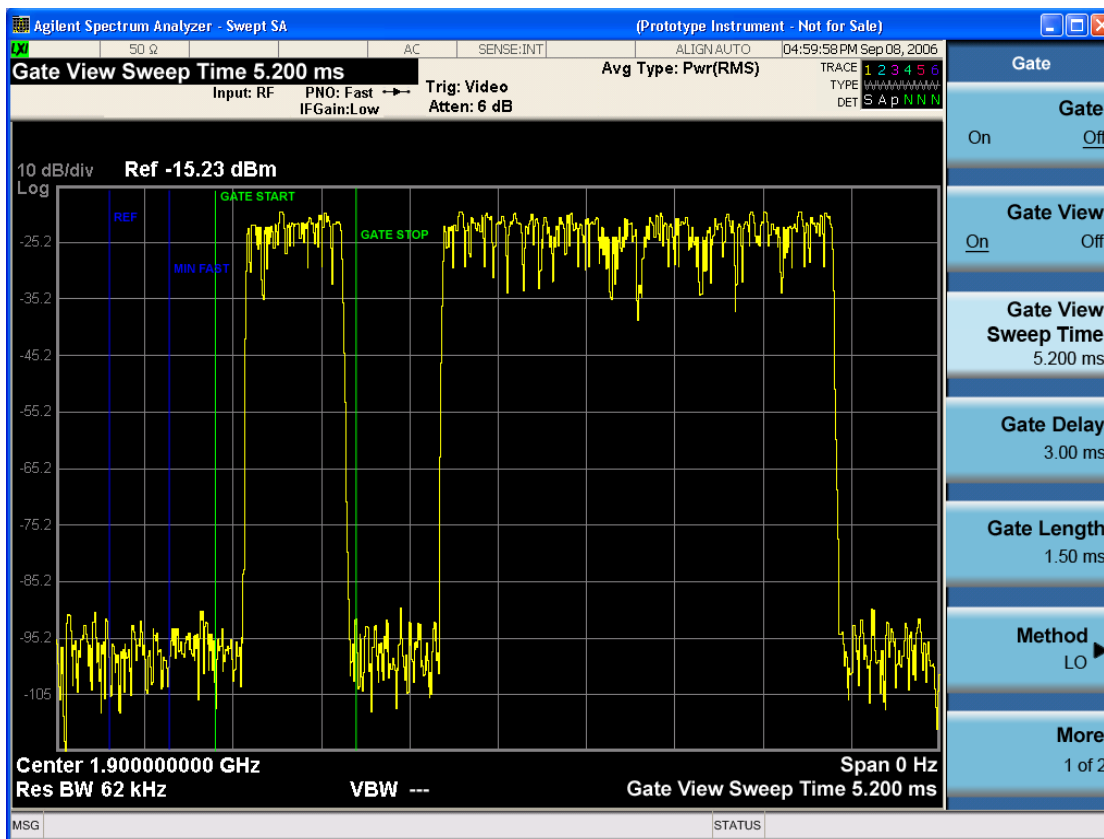

A sample of the Gate View screen in other measurements is shown below. This example is for the ACP measurement:

Sweep / Control

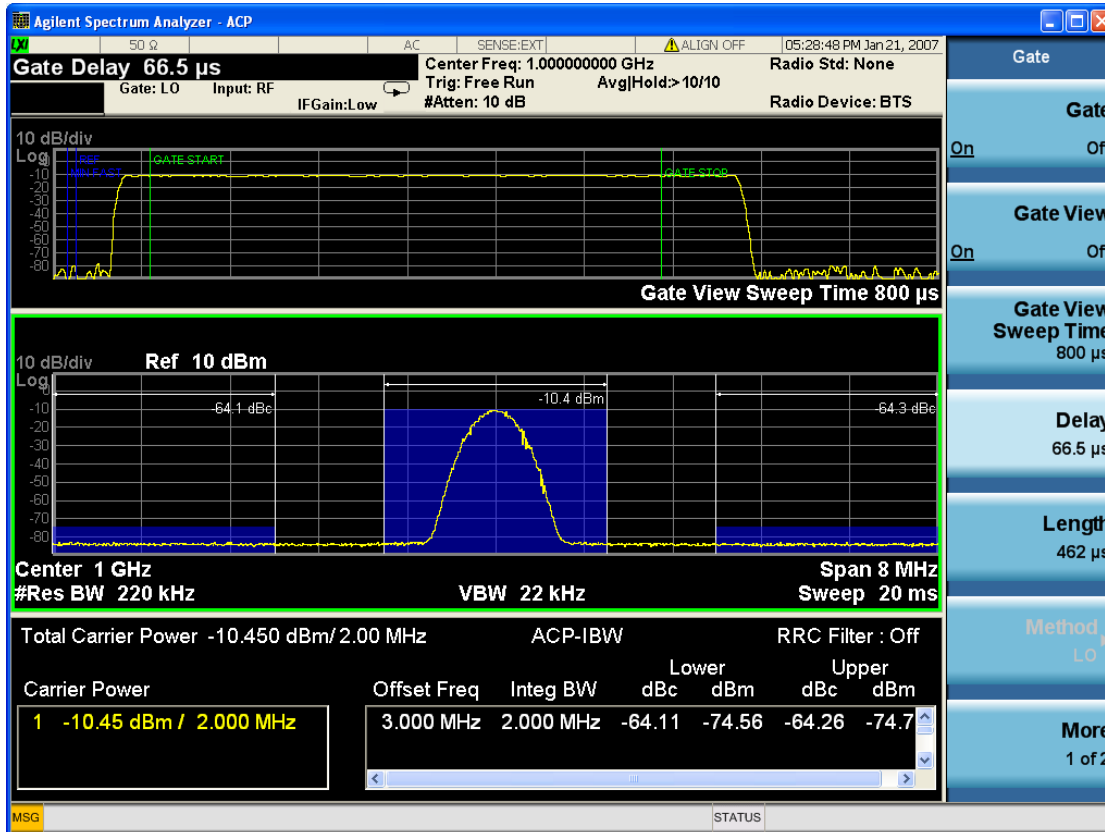

Turning Gate View off returns the analyzer to the Normal measurement view.

In the Swept SA, the normal measurement view is the single-window Swept SA view. When returning to this view, the Swept SA measurement returns to the Span it was in before entering **Gate View** (even if that is Zero Span).

The **Gate View** window is triggered from the Gate Source, with zero trigger delay. Also, when updating the **Gate View** window, the Gate itself must not operate. So it is internally shut off while the gate view window is being updated. For the Swept SA measurement, this means that the Gate is internally shut off whenever the gate view window is displayed. The Meas Bar and keys continue to show the Trigger source for the main sweep window and give no indication that the Gate is shut off or that the Gate View window is triggered from the Gate Source.

When in **Gate View**, vertical lines are displayed in the Gate View window as follows:

- Green lines are displayed at the gate edges as follows: in Edge Gate, a line is shown for Delay and one for the end of the Gate period (defined by Length, even in FFT. In Level Gate a line is shown only for Delay. You can adjust the position of the green lines by adjusting the gate length and the gate delay. These lines update in the Gate View window as the active function changes, even if the window is not being updated. In Gated LO and Gated Video, these lines are positioned relative to the delay reference line (not relative to 0 time). In Gated FFT, their location is relative to the left edge of the screen.
- A blue line is displayed showing the delay reference, that is, the reference point for the Gate Delay within the Zero Span window. The blue line represents where (in time) the effective location of the gate start would be if the gate were programmed to zero delay.

- The second blue line is labeled "MIN FAST" as shown in the figure above because it represents the minimum Gate Delay for fast Gated LO operation. This line is only displayed in Gated LO. You cannot scroll (knob) or decrement (down key) the Gate Delay to less than that represented by the position of this line, it can only be set below this position manually, although once there it can be moved freely with the knob while below the line.
- A yellow line in the Gated Video case only, is displayed at Blength, where Blength is the bucket length for the swept trace, which is given by the sweep time for that trace divided by number of Points – 1. So it is referenced to 0 time, not to the delay reference. This line is labeled NEXT PT (it is not shown in the figure above because the figure above is for Gated LO). The yellow line represents the edge of a display point (bucket). Normally in Gated Video, the bucket length must be selected so that it exceeds the off time of the burst. There is another way to use the analyzer in Gated Video measurements, and that is to set the bucket width much shorter than the off time of the burst. Then use the Max Hold trace function to fill in "missing" buckets more slowly. This allows you to see some of the patterns of the Gated Video results earlier, though seeing a completely filled-in spectrum later.

Gate View Sweep Time

Controls the sweep time in the Gate View window. In order to provide an optimal view of the gate signal, the analyzer initializes Gate View Sweep Time based on the current settings of Gate Delay and Gate Length.

Remote Command: [:SENSe] :SWEep:EGATe:TIME <time>
 [:SENSe] :SWEep:EGATe:TIME?

Example: SWE:EGAT:TIME 500 ms

Sweep / Control

Dependencies/Couplings: Gate View Sweep Time is initialized:
on Preset (after initializing delay and length).
every time the Gate Method is set/changed.

Additionally, in the Swept SA measurement, whenever you do a Preset, or leave Gate View, the analyzer remembers the Gate Delay and Gate Length settings. Then, when returning to Gate View, if the current Gate Delay and/or Gate Length do not match the remembered values Gate View Sweep Time is re-initialized.

1. Compute the location of the "gate stop" line, which you know is at time $t = t_{min} + GateDelay + GateLength$.

Preset: 519.3 μ s
WiMAX OFDMA: 5 ms
GSM/EDGE: 1 ms

State Saved: Saved in state

Min: 1 μ s

Max: 6000 s

Key Path: **Sweep/Control, Gate**

Instrument S/W Revision: Prior to A.02.00

Gate Delay

Controls the length of time from the time the gate condition goes True until the gate is turned on.

Remote Command: [:SENSe]:SWEep:EGATe:DELaY <time>
[:SENSe]:SWEep:EGATe:DELaY?

Example: SWE:EGAT:DELaY 500ms
SWE:EGAT:DELaY?

Remote Command Notes:	Units of time are required or no units; otherwise an invalid suffix error will be generated. See error –131.
Preset:	57.7 us WiMAX OFDMA: 71 us GSM/EDGE: 600 us
State Saved:	Saved in state
Min:	0.0 us
Max:	100 s
Key Path:	Sweep/Control, Gate
Instrument S/W Revision:	Prior to A.02.00

Gate Length

Controls the length of time that the gate is on after it opens.

Remote Command:	[:SENSe] :SWEep :EGATe :LENGth <time> [:SENSe] :SWEep :EGATe :LENGth?
Example:	SWE:EGAT:LENG 1 SWE:EGAT:LENG?
Dependencies/Couplings:	Grayed out when Gate Method is set to FFT in which case the label changes to that shown below.

<p>Gate Length (=1.83/RBW) 2.8 ms</p>
--

vsd 39-1

The key is also grayed out if Gate Control = Level.

Remote Command Notes:	Units of time are required or no units; otherwise an invalid suffix will be generated.
Preset:	461.6 us WiMAX OFDMA: 50 us GSM/EDGE: 200 us
State Saved:	Saved in state
Min:	100 ns
Max:	5 s
Key Path:	Sweep/Control, Gate

Sweep / Control

Instrument S/W Revision: Prior to A.02.00

Method

This lets you choose one of the three different types of gating.

Not all types of gating are available for all measurements.

Remote Command: [:SENSe] :SWEep:EGATe:METhod LO|VIDeo|FFT
[:SENSe] :SWEep:EGATe:METhod?

Example: SWE:EGAT:METH FFT

Preset: LO

State Saved: Saved in state

Key Path: **Sweep/Control, Gate**

Instrument S/W Revision: Prior to A.02.00

LO When set to Gate (On), the LO sweeps whenever the gate conditions as specified in the Gate menu are satisfied by the signal at the Gate Source.

This form of gating is more sophisticated, and results in faster measurements. With Gated LO, the analyzer only sweeps while the gate conditions are satisfied. This means that a sweep could take place over several gate events. It would start when the gate signal goes true and stop when it goes false, then continue when it goes true again. But since the LO is sweeping as long as the gate conditions are satisfied, the sweep typically finishes much more quickly than with Gated Video.

When in zero span, there is no actual sweep performed. But data is only taken while the gate conditions are satisfied. So even though there is no sweep, the gate settings will impact when data is acquired.

Dependencies/Couplings: Key is unavailable when Gate is On and FFT Sweep Type manually selected.
When selected, Sweep Type is forced to Swept and the FFT key in Sweep Type is grayed out.

Key Path: **Sweep/Control, Gate, Method**

Readback: LO

Instrument S/W Revision: Prior to A.02.00

Video When set to Gate (On), the video signal is allowed to pass through whenever the gate conditions as specified in the Gate menu are satisfied by the signal at the Gate Source.

This form of gating may be thought of as a simple switch, which connects the signal to the input of the spectrum analyzer. When the gate conditions are satisfied, the switch is closed, and when the gate conditions are not satisfied, the switch is open. So we only look at the signal while the gate conditions are satisfied.

With this type of gating, you usually set the analyzer to sweep very slowly. In fact, a general rule is to

sweep slowly enough that the gate is guaranteed to be closed at least once per bucket (data measurement interval). Then if the peak detector is used, each bucket will represent the peak signal as it looks with the gate closed.

Dependencies/Couplings:	Key is unavailable when Gate is On and FFT Sweep Type manually selected. When selected, Sweep Type is forced to Swept and the FFT key in Sweep Type is grayed out
Key Path:	Sweep/Control, Gate, Method
Readback:	Video
Instrument S/W Revision:	Prior to A.02.00

FFT When set to Gate (On), the an FFT is performed whenever the gate conditions as specified in the Gate menu are satisfied by the signal at the Gate Source. This is an FFT measurement which begins when the gate conditions are satisfied. Since the time period of an FFT is approximately $1.83/\text{RBW}$, you get a measurement which starts under predefined conditions and takes place over a predefined period. So, in essence, this is a gated measurement. You have limited control over the gate length but it works in FFT sweeps, which the other two methods do not.

Gated FFT cannot be done in zero span since the instrument is not sweeping. So in zero span the Gated LO method is used. Data is still only taken while the gate conditions are satisfied, so the gate settings do impact when data is acquired.

The Gate Length will be $1.83/\text{RBW}$.

This is a convenient way to make a triggered FFT measurement under control of an external gating signal.

Dependencies/Couplings:	Key is unavailable when Gate is On and Swept Sweep Type manually selected. Key is unavailable when gate Control is set to Level. When selected, Sweep Type is forced to FFT and the Swept key in Sweep Type is grayed out Forces Gate Length to $1.83/\text{RBW}$ (see Length key description above)
Key Path:	Sweep/Control, Gate
Readback:	FFT
Instrument S/W Revision:	Prior to A.02.00

Gate Source

The menus under the **Gate Source** key follow the same pattern as those under **Trigger**, with the exception that neither **Free Run** nor **Video** are available as Gate Source selections. Any changes to the settings in the setup menus under each Gate Source selection key (for example: **Trigger Level**) also affect the settings under the Trigger menu keys. Note that the selected Trigger Source does not have to

Sweep / Control

match the Gate Source.

Remote Command:	[:SENSe] :SWEep:EGATe:SOURce EXTernal1 EXTernal2 LINE FRAME RFBurst TV [:SENSe] :SWEep:EGATe:SOURce?
Preset:	EXTernal 1 GSM/EDGE: FRAME
Key Path:	Sweep/Control, Gate
Dependencies/Couplings:	TV triggering is not available yet.
Instrument S/W Revision:	Prior to A.02.00

Control Edge/Level

Sets the method of controlling the gating function from the gating signal.

Edge

In Edge triggering, the gate opens (after the Delay) on the selected edge (for example, positive) of the gate signal and closes on the alternate edge (for example, negative).

Level

In Level triggering, the gate opens (after the Delay) when the gate signal has achieved a certain level and stays open as long as that level is maintained.

Remote Command:	[:SENSe] :SWEep:EGATe:CONTRol EDGE LEVEl [:SENSe] :SWEep:EGATe:CONTRol?
Example:	SWE:EGAT:CONT EDGE
Dependencies/Couplings:	If the Gate Method is FFT the Control key is grayed out and Edge is selected. If the Gate Source is TV, Frame or Line, the Control key is grayed out and Edge is selected.
Preset:	EDGE
State Saved:	Saved in stat
Key Path:	Sweep/Control, Gate
Instrument S/W Revision:	Prior to A.02.00

Gate Holdoff

Lets you increase or decrease the wait time after a gate event ends before the analyzer will respond to the next gate signal.

After any Gate event finishes, the analyzer must wait for the sweep system to settle before it can respond to another Gate signal. The analyzer calculates a "wait time," taking into account a number of factors,

including RBW and Phase Noise Optimization setting. The goal is to achieve the same accuracy when gated as in ungated operation. The figure below illustrates this concept:

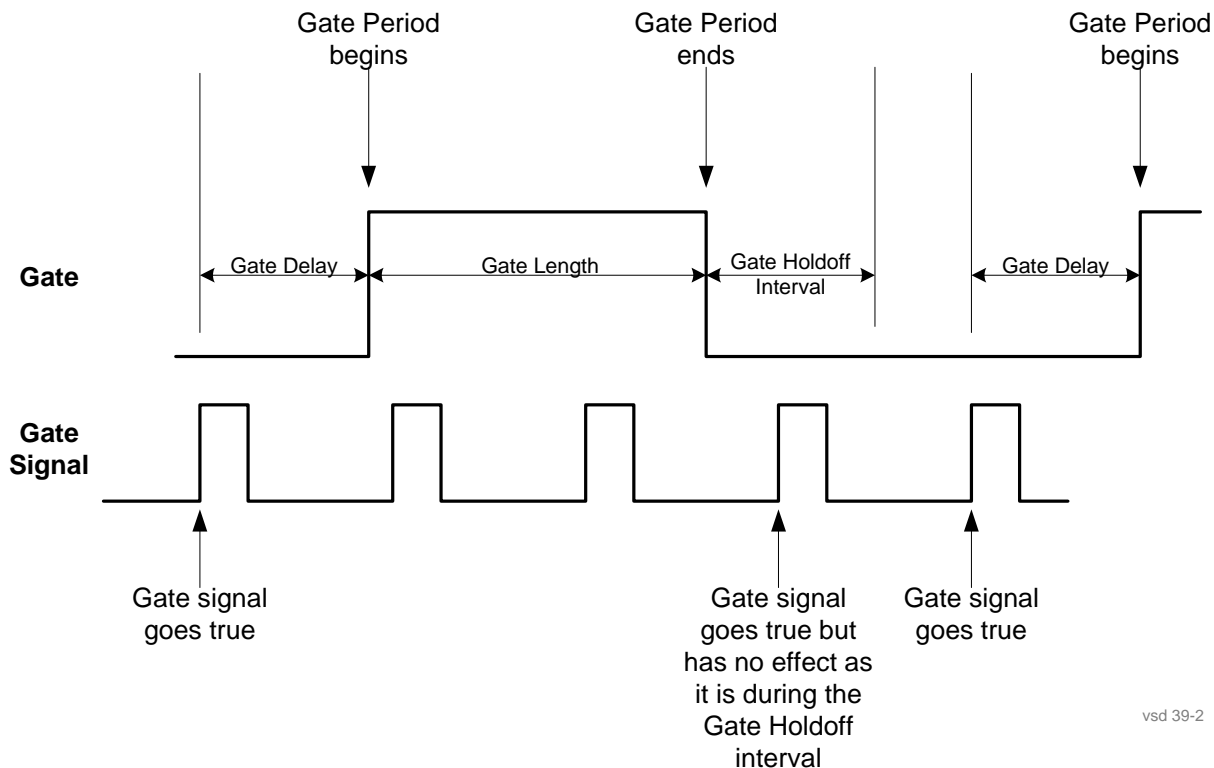

When Gate Holdoff is in Auto, the wait time calculated by the analyzer is used. When Gate Time is in Manual, you may adjust the wait time, usually decreasing it in order to achieve greater speed, but at the risk of decreasing accuracy.

When **Method** is set to **Video** or **FFT**, the **Gate Holdoff** function has no effect.

In measurements that do not support Auto, the value shown when Auto is selected is "---" and the manually set holdoff is returned to a query.

Remote Command

```
[ :SENSe ] :SWEep:EGATe:HOLDoff <time>
[ :SENSe ] :SWEep:EGATe:HOLDoff?
[ :SENSe ] :SWEep:EGATe:HOLDoff:AUTO OFF|ON|0|1
[ :SENSe ] :SWEep:EGATe:HOLDoff:AUTO?
```

Sweep / Control

Dependencies/Couplings	<p>When Gate Holdoff is Auto, the Gate Holdoff key shows the value calculated by the analyzer for the wait time.</p> <p>Pressing the Gate Holdoff key while it is in Auto and not selected, causes the key to become selected and allows you to adjust the value. If the value is adjusted, the setting changes to Man.</p> <p>Pressing the Gate Holdoff key, while it is in Auto and selected, does not change the value of Gate Holdoff, but causes the setting to change to Man. Now you can adjust the value.</p> <p>Pressing the key while it is in Man and selected, cause the value to change back to Auto.</p> <p>Pressing the key while it is in Man and not selected, causes the key to become selected and allows you to adjust the value.</p> <p>When Method is set to Video or FFT, the Gate Holdoff function has no effect.</p> <p>See Coupling, above</p>
Example	<pre>SWE:EGAT:HOLD 0.0002 SWE:EGAT:HOLD? SWE:EGAT:HOLD:AUTO ON SWE:EGAT:HOLD:AUTO?</pre>
Key Path	Sweep/Control, Gate
Mode	SA, WCDMA, C2K, WIMAX OFDMA, TD-SCDMA, 1xEVDO
Preset	Auto Auto/On
State Saved	Saved in instrument state.
Min	1 µsec
Max	1 sec
Instrument S/W Revision	Prior to A.02.00

Gate Delay Compensation

This function allows you to select an RBW-dependent value by which to adjust the gate delay, to compensate for changes in the delay caused by RBW effects. The intent is to make it unnecessary for you to worry about the effects that RBW will have on the gate circuitry, by automatically compensating for them.

You can select between uncompensated operation and two types of compensation, **Delay Until RBW Settled** and **Compensate for RBW Group Delay**.

See “More Information” on page 1249

Remote Command:	[:SENSe] :SWEep :EGATe :DELay :COMPensation :TYPE OFF SETTled GDELay [:SENSe] :SWEep :EGATe :DELay :COMPensation :TYPE?
Example:	SWE:EGAT:DEL:COMP:TYPE SETT SWE:EGAT:DEL:COMP:TYPE?
Scope:	Meas Global
Range:	Uncompensated Delay Until RBW Settled Compensate for RBW Group Delay
Readback text:	Uncompensated Settled Group Delay
Preset:	TD-SCDMA mode: Compensate for RBW Group Delay All other modes: Delay Until RBW Settled
State Saved:	Saved in state
Key Path:	Sweep/Control, Gate
Notes:	Although this function is Meas Global, there are some measurements that do not support this function. In those measurements the operation will be Uncompensated. Going into one of those measurements will not change the Meas Global selection; it will simply display the grayed-out menu key with “Uncompensated” showing as the selection. This is a non-forceful grayout, so the SCPI command is still accepted. If Gate Delay Compensation is not supported at all within a particular mode, the key is not displayed, and if the SCPI command is sent while in a measurement within that mode, an “Undefined Header” error is generated. Measurements that do not support this function include: Swept SA
Instrument S/W Revision:	Prior to A.02.00

More Information

Selecting **Uncompensated** means that the actual gate delay is as you set it.

Selecting **Delay Until RBW Settled** causes the gate delay to be increased above the user setting by an amount equal to $3.06/\text{RBW}$. This compensated delay causes the GATE START and GATE STOP lines on the display to move by the compensation amount, and the actual hardware gate delay to be increased by the same amount. All the other gate lines (for example, MIN FAST) are unaffected. If the RBW subsequently changes, the compensation is readjusted for the new RBW. The value shown on the **Gate Delay** key does NOT change.

Delay Until RBW Settled allows excellent measurements of gated signals, by allowing the IF to settle following any transient that affects the burst. Excellent measurements also require that the analysis region not extend into the region affected by the falling edge of the burst. Thus, excellent measurements can only be made over a width that declines with narrowing RBWs. Therefore, for general purpose

Sweep / Control

compensation, you will still want to change the gate length with changes in RBW even if the gate delay is compensated.

Selecting **Compensate for RBW Group Delay** causes the gate delay to be increased above the user setting by an amount equal to $1.81/\text{RBW}$. This compensated delay causes the GATE START, GATE STOP lines on the display to move by the compensation amount, and the actual hardware gate delay to be increased by the same amount. All the other gate lines (for example, MIN FAST) are unaffected. If the RBW subsequently changes, the compensation is readjusted for the new RBW. The value shown on the **Gate Delay** key does NOT change. **Compensate for RBW Group Delay** also includes gate length compensation; the gate length itself is adjusted as necessary to attempt to compensate for delay effects imposed by the RBW.

Compensate for RBW Group Delay is similar to **Delay Until RBW Settled**, but compensates for the group delay of the RBW filter, rather than the filter settling time. As the RBW gets narrow, this can allow the settling tail of the RBW to affect the beginning part of the gated measurement, and allow the beginning of the RBW settling transient to affect the end of the gated measurement. These two effects are symmetric because the RBW response is symmetric. Because the gate length is not automatically compensated, some users might find this compensation to be more intuitive than compensation for RBW settling.

Min Fast Position Query (Remote Command Only)

This command queries the position of the MIN FAST line, relative to the delay reference (REF) line. See section [“Gate View On/Off” on page 1237](#). If this query is sent while not in gate view, the MinFast calculation is performed based on the current values of the appropriate parameters and the result is returned. Knowing this value lets you to set an optimal gate delay value for the current measurement setup.

Remote Command: [:SENSe] :SWEp:EGATe:MINFast?

Example: SWE:EGAT:MIN?

Instrument S/W Revision: Prior to A.02.00

Trace / Detector

Trace/Detector features are unique to each Measurement. See the specific Measurement for more information.

The front panel key accesses keys to control Trace and Detector settings.

Key Path	Front-panel key
Instrument S/W Revision	Prior to A.02.00

Trigger

The Trig front-panel key accesses a menu of keys to control the selection of the trigger source and the setup of each of the trigger sources. The analyzer is designed to allow triggering from a number of different sources, for example, Free Run, Video, External, RF Burst, etc.

The TRIG:SOURce command (below) will specify the trigger source for the currently selected input (RF or I/Q). If you change inputs, the new input remembers the trigger source it was last programmed to for the current measurement, and uses that trigger source. You can directly set the trigger source for each input using the TRIGger:RF:SOURce and TRIGger:IQ:SOURce commands (later in this section).

Note the inclusion of the <measurement> parameter in the command below. Because each measurement remembers its own Trigger Source, the command must be qualified with the measurement name. Note that for the Swept SA measurement this is not the case; for backwards compatibility, no <measurement> parameter is used when setting the Trigger Source for the Swept SA measurement.

See [“Trigger Source Presets” on page 1255](#)

See [“RF Trigger Source” on page 1257](#)

See [“I/Q Trigger Source” on page 1258](#)

See [“More Information” on page 1259](#)

Remote Command

```
:TRIGger:<measurement>[:SEquence]:SOURce
EXTernal1|EXTernal2|IMMediate|LINE|FRAMe|RFBurst|VIDeo|
IF|ALARm|LAN|IQMag|IDEMod|QDEMod|IINPut|QINPut|AIQMag
:TRIGger:<measurement>[:SEquence]:SOURce?
```

Example

```
TRIG:ACP:SOUR EXT1
```

Selects the external 1 trigger input for the ACP measurement and the selected input

```
TRIG:SOUR VID
```

Selects video triggering for the SANalyzer measurement in the Spectrum Analyzer mode. For SAN, do not use the <measurement> keyword.

Trigger

Remote Command Notes	<p>Not all measurements have all the trigger sources available to them. Check the trigger source documentation for your specific measurement to see what sources are available.</p> <p>Not all trigger sources are available for each input. See the “RF Trigger Source” on page 1257 and “I/Q Trigger Source” on page 1258 commands (below) for detailed information on which trigger sources are available for each input.</p> <p>Other trigger-related commands are found in the INITiate and ABORt SCPI command subsystems.</p> <p>*OPC should be used after requesting data. This will hold off any subsequent changes to the selected trigger source, until after the sweep is completed and the data is returned.</p> <p>Available ranges and presets can vary from mode to mode.</p>
SCPI Status Bits/OPC Dependencies	<p>The Status Operation Register bit 5 "Waiting for Trigger" is set at the same time as the Sweeping or Measuring bit is set. It is cleared when the trigger actually occurs (that is, after the trigger event occurs and all the applicable trigger criteria have been met). A corresponding pop-up message ("Waiting for trigger") is generated if no trigger signal appears after approximately 2 sec. This message goes away when a trigger signal appears.</p>
Key Path	Front-panel key
Preset	See table below
Instrument S/W Revision	Prior to A.02.00

Trigger Source Presets

Here are the Trigger Source Presets for the various measurements:

Meas	Mode	Preset for RF	Preset for IQ	Notes
Swept SA	SA	IMM	IQ not supported	
CHP	SA, WCDMA, C2K, WIMAX OFDMA, 1xEVDO, DVB-T/H, DTMB	IMM	IQ not supported	
OBW	SA, WCDMA, C2K, WIMAX OFDMA, TD-SCDMA, 1xEVDO	1xEVDO: EXT1 others: IMM	IQ not supported	For 1xEVDO mode, the trigger source is coupled with the gate state, as well as the gate source. When the trigger source changes to RFBurst, External1 or External2, the gate state is set to on, and the gate source is set identically with the trigger source. When the trigger source changes to IMMEDIATE, VIDEO, LINE, FRAME or IF, the gate state is set to off.
CCDF	SA, WCDMA, C2K, WIMAX OFDMA, TD-SCDMA, 1xEV-DO, DVB-T/H, DTMB	SA, WCDMA, C2K: IMMEDIATE WIMAX OFDMA: RFBurst TD-SCDMA: BTS: External 1 MS: RFBurst	TD-SCDMA: BTS: External 1 MS: IQMag Others: IMM	For TD-SCDMA: Trigger source is coupled with radio device. When radio device changes to BTS, trigger source will be changed to EXTERNAL1. When radio device changes to MS, trigger source will be set as RFBurst for RF or IQ Mag for BBIQ. When TriggerSource is RFBurst or IQ Mag, Measure Interval is grayed out.
ACP	SA, WCDMA, C2K, WIMAX OFDMA, TD-SCDMA, 1xEVDO, DVB-T/H, DTMB	IMM	IQ not supported	

Trigger

Meas	Mode	Preset for RF	Preset for IQ	Notes
Tx Power	SA, GSM, TD-SCDMA	SA, GSM: RFBurst TD-SCDMA: EXTernal	IMM	TD-SCDMA doesn't support the Line and Periodic Timer parameters. When the mode is TD-SCDMA, if the Radio Device is switched to BTS, the value will be changed to External 1 and if the Radio device is switched to MS, the value will be changed to RFBurst
SPUR	SA, WCDMA, C2K, WIMAX OFDMA, TD-SCDMA, 1xE V-DO, DVB-T/H	IMM	IQ not supported	
SEM	SA, WCDMA, C2K, WIMAX OFDMA, TD-SCDMA, 1xEVDO, DVB-T/H, DTMB	SA, WCDMA, C2K, TD-SCDMA, WIMAX OFDMA: IMMediate 1xEVDO(BTS): EXTernal1	IQ not supported	
CDP	WCDMA	IMM	IMM	
RHO	WCDMA	IMM	IMM	
PCON	WCDMA	IMM	IMM	
QPSK	WCDMA, C2K, 1xEVDO	All except CDMA 1xEVDO: IMMediate CDMA 1xEVDO: EXT1	IMM	
MON	All except SA and BASIC	IMM	IQ not supported	
WAV		All except GSM/EDGE: IMMediate GSM/EDGE: RFBurst	All except GSM/EDGE: IMMediate GSM/EDGE: IQMag	
PVT	WIMAX OFDMA	RFB	IMM	
EVM	WIMAX OFDMA, DVB-T/H, DTMB	IMM	IMM	

Meas	Mode	Preset for RF	Preset for IQ	Notes
SPEC	BASIC	IMM	IMM	
LOG Plot	PN	IMM	IQ not supported	
Spot Freq	PN	IMM	IQ not supported	
GMSK PVT	EDGE/GSM	RFB	IMM	
GMSK PFER	EDGE/GSM	RFB	IQMag	
GMSK ORFS	EDGE/GSM	RFB	IQ not supported	
EDGE PVT	EDGE/GSM	RFB	IMM	
EDGE EVM	EDGE/GSM	RFB	IQMag	
EDGE ORFS	EDGE/GSM	RFB	IQ not supported	
Combined WCDMA	WCDMA	IMM	IQ not supported	
Combined GSM	EDGE/GSM	RFB	IQ not supported	
List Power Step	WCDMA, EDGE/GSM	IMM	IQ not supported	

RF Trigger Source

The **RF Trigger Source** command (below) selects the trigger to be used for the specified measurement when RF is the selected input. The RF trigger source can be queried and changed even while another input is selected, but it is inactive until RF becomes the selected input.

Note the inclusion of the <measurement> parameter in the command below. Because each measurement remembers its own Trigger Source, the command must be qualified with the measurement name. Note that for the Swept SA measurement this is not the case; for backwards compatibility, no <measurement> parameter is used when setting the Trigger Source for the Swept SA measurement.

Remote Command:

```
:TRIGger:<measurement>[:SEquence]:RF:SOURce
EXTernal1|EXTernal2|IMMEDIATE|LINE|FRAME|RFBurst|VIDeo|
IF|ALARM|LAN
:TRIGger:<measurement>[:SEquence]:RF:SOURce?
```

Trigger

Example:	<p>TRIG:ACP:RF:SOUR EXT1</p> <p>Selects the external 1 trigger input for the ACP measurement and the RF input</p> <p>TRIG:RF:SOUR VID</p> <p>Selects video triggering for the SANalyzer measurement and the RF input. For SAN, do not use the <measurement> keyword.</p>
Remote Command Notes:	<p>Not all measurements have all the trigger sources available to them. Check the trigger source documentation for your specific measurement to see what sources are available.</p> <p>Not all trigger sources are available for each input. For the RF Trigger Source, the following trigger sources are available:</p> <ul style="list-style-type: none">— IMMEDIATE - free run triggering— VIDEO - triggers on the video signal level— LINE - triggers on the power line signal— EXTERNAL1 - triggers on an externally connected trigger source on the rear panel— EXTERNAL2 - triggers on an externally connected trigger source on the front panel— RFBURST - triggers on the bursted frame— FRAME - triggers on the periodic timer— IF (video) - same as video, for backwards compatibility only— ALARM – LXI Alarm— LAN – LXI LAN event <p>*OPC should be used after requesting data. This will hold off any subsequent changes to the selected trigger source, until after the sweep is completed and the data is returned.</p> <p>Available ranges, and presets can vary from mode to mode.</p>
SCPI Status Bits/OPC Dependencies:	<p>The Status Operation Register bit 5 "Waiting for Trigger" is set at the same time as the Sweeping or Measuring bit is set. It is cleared when the trigger actually occurs (that is, after the trigger event occurs and all the applicable trigger criteria have been met). A corresponding pop-up message ("Waiting for trigger") is generated if no trigger signal appears after approximately 2 sec. This message goes away when a trigger signal appears.</p>
Instrument S/W Revision:	Prior to A.02.00

I/Q Trigger Source

The **I/Q Trigger Source** command (below) selects the trigger to be used for the specified measurement when I/Q (which requires option BBA) is the selected input. The I/Q trigger source can be queried and

changed even while another input is selected, but it is inactive until I/Q becomes the selected input.

Remote Command: :TRIGger:<measurement>[:SEquence]:IQ:SOURce
EXTernal1|EXTernal2|IMMediate|IQMag|IDEMod|QDEMod|IINPut
t|QINPut|AIQMag

:TRIGger:<measurement>[:SEquence]:IQ:SOURce?

Example: TRIG:WAVEform:SOUR IQM

Selects I/Q magnitude triggering for the IQ Waveform measurement and the I/Q input

Remote Command Notes: Not all measurements have all the trigger sources available to them. Check the trigger source documentation for your specific measurement to see what sources are available.

Not all trigger sources are available for each input. For the **I/Q Trigger Source**, the following trigger sources are available:

- IMMediate - free run triggering
- EXTernal1 - triggers on an externally connected trigger source on the rear panel
- EXTernal2 - triggers on an externally connected trigger source on the front panel
- IQMag - triggers on the magnitude of the I/Q signal
- IDEMod - triggers on the I/Q signal's demodulated I voltage
- QDEMod - triggers on the I/Q signal's demodulated Q voltage
- IINPut - triggers on the I channel's ADC voltage
- QINPut - triggers on the Q channel's ADC voltage
- AIQMag - triggers on the magnitude of the auxiliary receiver channel I/Q signal

*OPC should be used after requesting data. This will hold off any subsequent changes to the selected trigger source, until after the sweep is completed and the data is returned.

Available ranges, and presets can vary from mode to mode.

SCPI Status Bits/OPC
Dependencies: The Status Operation Register bit 5 "Waiting for Trigger" is set at the same time as the Sweeping or Measuring bit is set. It is cleared when the trigger actually occurs (that is, after the trigger event occurs and all the applicable trigger criteria have been met). A corresponding pop-up message ("Waiting for trigger") is generated if no trigger signal appears after approximately 2 sec. This message goes away when a trigger signal appears.

Instrument S/W Revision: Prior to A.02.00

More Information

The trigger menus let you select the trigger source and trigger settings for a sweep or measurement. In triggered operation (basically, any trigger source other than Free Run), the analyzer will begin a sweep or

Trigger

measurement only with the selected trigger conditions are met, generally when your trigger source signal meets the specified trigger level and polarity requirements. (In FFT measurements, the trigger controls when the data acquisition begins for FFT conversion.)

For each of the trigger sources, you may define a set of operational parameters or settings which will be applied when that source is selected as the current trigger source. Examples of these settings are Trigger Level, Trigger Delay, and Trigger Slope. You may apply different settings for each source; so, for example, you could have a Trigger Level of 1v for External 1 trigger and -10 dBm for Video trigger.

Once you have established the settings for a given trigger source, they generally will remain unchanged for that trigger source as you go from measurement to measurement within a Mode (although the settings do change as you go from Mode to Mode). Furthermore, the trigger settings within a Mode are the same for the **Trigger** menu, the **Gate Source** menu, and the **Sync Source** menu that is part of the **Periodic Timer Trigger Setup** menu. That is, if **Ext1** trigger level is set to 1v in the **Trigger** menu, it will appear as 1v in both the **Gate Source** and the **Sync Source** menus. For these reasons the trigger settings commands are not qualified with the measurement name, the way the trigger source commands are.

The settings setup menu can be accessed by pressing the key for the current trigger source a second time. For example, one press of Video selects the Video trigger as the source. The Video key becomes highlighted and the hollow arrow on the key turns black. Now a second press of the key takes you into the Video Trigger Setup menu.

Trigger Setup Parameters:

The following examples show trigger setup parameters using an external trigger source.

Example 1 illustrates the trigger conditions with negative slope and no trigger occurs during trigger Holdoff time.

Example 2 illustrates the trigger conditions with positive slope, trigger delay, and auto trigger time.

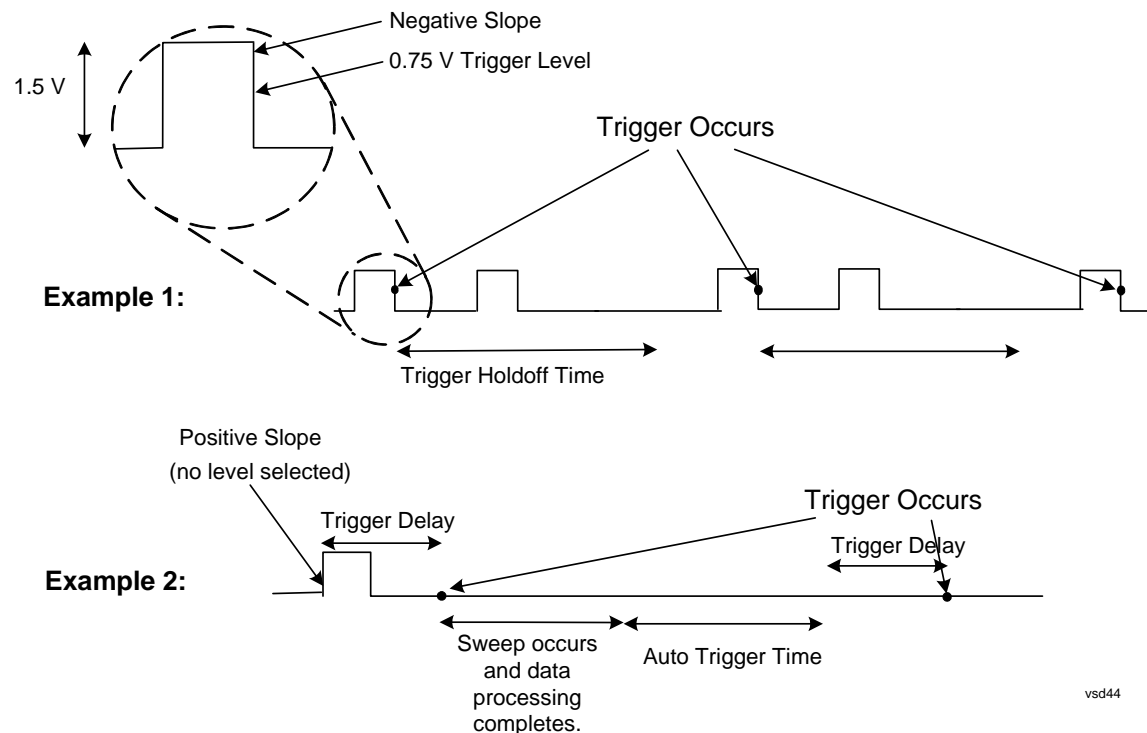

vsd44

Free Run

Pressing this key, when it is not selected, selects free-run triggering. Free run triggering occurs immediately after the sweep/measurement is initiated.

Example:	TRIG:SOUR IMM	Swept SA measurement
	TRIG:<meas>:SOUR IMM	Measurements other than Swept SA
State Saved:	Saved in instrument state.	
Key Path:	Trigger	
SCPI Status Bits/OPC Dependencies:	The Status Operation Register bit 5 "Waiting for Trigger" is set at the same time as the Sweeping or Measuring bit is set. It is cleared when the trigger actually occurs (that is, after the trigger event occurs and all the applicable trigger criteria have been met). A corresponding pop-up message ("Waiting for trigger") is generated if no trigger signal appears after approximately 2 sec. This message goes away when a trigger signal appears.	
Instrument S/W Revision:	Prior to A.02.00	

Video (IF Envelope)

Pressing this key, when it is not selected, selects the video signal as the trigger. The Video trigger condition is met when the video signal (the filtered and detected version of the input signal, including both RBW and VBW filtering) crosses the video trigger level.

NOTE When the detector selected for all active traces is the average detector, the video signal for triggering does not include any VBW filtering.

The video trigger level is shown as a labeled line on the display. The line is displayed as long as video is the selected trigger source.

Pressing this key, when it is already selected, accesses the video trigger setup functions.

Example:	TRIG:SOUR VID	Swept SA measurement
	TRIG:<meas>:SOUR VID	Measurements other than Swept SA
Dependencies/Couplings:	Video trigger is allowed in average detector mode.	
State Saved:	Saved in instrument state.	
Key Path:	Trigger	
Notes:	Log Plot and Spot Frequency measurements do not support Video Trigger	

Trigger

SCPI Status Bits/OPC Dependencies: The Status Operation Register bit 5 "Waiting for Trigger" is set at the same time as the Sweeping or Measuring bit is set. It is cleared when the trigger actually occurs (that is, after the trigger event occurs and all the applicable trigger criteria have been met). A corresponding pop-up message ("Waiting for trigger") is generated if no trigger signal appears after approximately 2 sec. This message goes away when a trigger signal appears.

Instrument S/W Revision: Prior to A.02.00

Trigger Level

Sets a level for the video signal trigger. When the video signal crosses this level, with the chosen slope, the trigger occurs. This level is displayed with a horizontal line only if **Video** is the selected trigger source.

Remote Command: :TRIGger[:SEquence]:VIDeo:LEVel <ampl>
:TRIGger[:SEquence]:VIDeo:LEVel?

Example: TRIG:VID:LEV -40 dBm

Dependencies/Couplings: This same level is used for the Video trigger source in the Trigger menu and for the Video selection in the Gate Source menu.

The range of the Video Trigger Level is dependent on the Reference Level.

Preset: Set the Video Trigger Level -25 dBm on Preset. When the Video Trigger Level becomes the active function, if the value is off screen, set it to either the top or bottom of screen, depending on which direction off screen it was.

State Saved: Saved in instrument state.

Min: Same as reference level

Max: Same as reference level

Key Path: **Trigger, Video**

Default Unit: depends on the current selected Y axis unit

Instrument S/W Revision: Prior to A.02.00

Trig Slope

Controls the trigger polarity. It is set positive to trigger on a rising edge and negative to trigger on a falling edge.

Remote Command: :TRIGger[:SEquence]:VIDeo:SLOPe POSitive|NEGative
:TRIGger[:SEquence]:VIDeo:SLOPe?

Example: TRIG:VID:SLOP NEG

Preset:	POSitive
State Saved:	Saved in instrument state.
Key Path:	Trigger, Video
Instrument S/W Revision:	Prior to A.02.00

Trig Delay

Controls a time delay during which the analyzer will wait to begin a sweep after meeting the trigger criteria. You can use negative delay to pre-trigger the instrument in time domain or FFT, but not in swept spans.

Remote Command:	:TRIGger[:SEquence]:VIDeo:DELAy <time> :TRIGger[:SEquence]:VIDeo:DELAy? :TRIGger[:SEquence]:VIDeo:DELAy:STATe OFF ON 0 1 :TRIGger[:SEquence]:VIDeo:DELAy:STATe?
------------------------	--

Example: TRIG:VID:DEL:STAT ON
TRIG:VID:DEL 100 ms

Preset:	Off, 1 us
State Saved:	Saved in instrument state.
Min:	-150 ms
Max:	+500 ms
Key Path:	Trigger, Video
Default Unit:	s
Instrument S/W Revision:	Prior to A.02.00

Line

Pressing this key, when it is not selected, selects the line signal as the trigger. A new sweep/measurement will start synchronized with the next cycle of the line voltage. Pressing this key, when it is already selected, access the line trigger setup menu.

Example: TRIG:SOUR LINE Swept SA measurement
TRIG:<meas>:SOUR LINE Measurements other than Swept SA

Dependencies/Couplings: Line trigger is not available when operating from a "dc power source", for example, when the instrument is powered from batteries.

State Saved: Saved in instrument state.

Trigger

Key Path: **Trigger**

SCPI Status Bits/OPC Dependencies: The Status Operation Register bit 5 "Waiting for Trigger" is set at the same time as the Sweeping or Measuring bit is set. It is cleared when the trigger actually occurs (that is, after the trigger event occurs and all the applicable trigger criteria have been met). A corresponding pop-up message ("Waiting for trigger") is generated if no trigger signal appears after approximately 2 sec. This message goes away when a trigger signal appears.

Instrument S/W Revision: Prior to A.02.00

Trig Slope

Controls the trigger polarity. It is set positive to trigger on a rising edge and negative to trigger on a falling edge.

Remote Command: `:TRIGger[:SEquence]:LINE:SLOPe POSitive|NEGative`
`:TRIGger[:SEquence]:LINE:SLOPe?`

Example: `TRIG:LINE:SLOP NEG`

Preset: POSitive

State Saved: Saved in instrument state.

Key Path: **Trigger, Line**

Instrument S/W Revision: Prior to A.02.00

Trig Delay

Controls a time delay during which the analyzer will wait to begin a sweep after meeting the trigger criteria. You can use negative delay to pre-trigger the instrument in time domain or FFT, but not in swept spans.

Remote Command: `:TRIGger[:SEquence]:LINE:DELay <time>`
`:TRIGger[:SEquence]:LINE:DELay?`
`:TRIGger[:SEquence]:LINE:DELay:STATe OFF|ON|0|1`
`:TRIGger[:SEquence]:LINE:DELay:STATe?`

Example: `TRIG:LINE:DEL:STAT ON`

`TRIG:LINE:DEL 100 ms`

Preset: Off, 1.000 us

State Saved: Saved in instrument state.

Min: -150 ms

Max: 500 ms

Key Path:	Trigger, Line
Default Unit:	S
Instrument S/W Revision:	Prior to A.02.00

External 1

Pressing this key, when it is not selected, selects an external input signal as the trigger. A new sweep/measurement will start when the external trigger condition is met using the external 1 input connector on the rear panel.

Pressing this key, when it is already selected, accesses the external 1 trigger setup menu.

Example:	TRIG:SOUR EXT1 Swept SA measurement
	TRIG:<meas>:SOUR EXT1 Measurements other than Swept SA
State Saved:	Saved in instrument state.
Key Path:	Trigger
SCPI Status Bits/OPC Dependencies:	The Status Operation Register bit 5 "Waiting for Trigger" is set at the same time as the Sweeping or Measuring bit is set. It is cleared when the trigger actually occurs (that is, after the trigger event occurs and all the applicable trigger criteria have been met). A corresponding pop-up message ("Waiting for trigger") is generated if no trigger signal appears after approximately 2 sec. This message goes away when a trigger signal appears.

Instrument S/W Revision:	Prior to A.02.00
--------------------------	------------------

Trigger Level

Sets the value where the external 1 trigger input will trigger a new sweep/measurement.

Remote Command:	:TRIGger[:SEquence]:EXTernal1:LEVel <level> :TRIGger[:SEquence]:EXTernal1:LEVel?
Example:	TRIG:EXT1:LEV 0.4 V
Dependencies/Couplings:	This same level is used for the Ext1 trigger source in the Trigger menu, for the Ext1 selection in the Periodic Timer sync source (in the Trigger menu and in the Gate Source menu), and also for the Ext1 selection in the Gate Source menu.
Preset:	1.2 V
State Saved:	Saved in instrument state.
Min:	-5 V
Max:	5 V

Trigger

Key Path: **Trigger, External 1**
Default Unit: V
Instrument S/W Revision: Prior to A.02.00

Trig Slope

Controls the trigger polarity. It is set positive to trigger on a rising edge and negative to trigger on a falling edge.

Remote Command: :TRIGger[:SEquence]:EXTernal1:SLOPe POSitive|NEGative
:TRIGger[:SEquence]:EXTernal1:SLOPe?

Example: TRIG:EXT1:SLOP NEG

Dependencies/Couplings: This same slope is used in the Ext1 selection for the trigger source in the Trigger menu and for the period timer sync source (in the Trigger menu and in the Gate Source menu).

Preset: POSitive

State Saved: Saved in instrument state.

Key Path: **Trigger, External 1**

Instrument S/W Revision: Prior to A.02.00

Trig Delay

Controls a time delay during which the analyzer will wait to begin a sweep after meeting the trigger criteria. You can use negative delay to pre-trigger the instrument in time domain or FFT, but not in swept spans.

Remote Command: :TRIGger[:SEquence]:EXTernal1:DELay <time>
:TRIGger[:SEquence]:EXTernal1:DELay?
:TRIGger[:SEquence]:EXTernal1:DELay:STATe OFF|ON|0|1
:TRIGger[:SEquence]:EXTernal1:DELay:STATe?

Example: TRIG:EXT1:DEL:STAT ON
TRIG:EXT1:DEL 100 ms

Preset: Off, 1.000 us

State Saved: Saved in instrument state.

Min: -150 ms

Max: +500 ms

Key Path: **Trigger, External 1**

Default Unit: s

Instrument S/W Revision: Prior to A.02.00

External 2

Pressing this key, when it is not selected, selects an external input signal as the trigger. A new sweep/measurement will start when the external trigger condition is met using the external 2 input connector. The external trigger 2 input connector is on the rear panel.

Pressing this key, when it is already selected, accesses the external 2 trigger setup menu.

Example:	TRIG:SOUR EXT2 Swept SA measurement TRIG:<meas>:SOUR EXT2 Measurements other than Swept SA
State Saved:	Saved in instrument state.
Key Path:	Trigger
SCPI Status Bits/OPC Dependencies:	The Status Operation Register bit 5 "Waiting for Trigger" is set at the same time as the Sweeping or Measuring bit is set. It is cleared when the trigger actually occurs (that is, after the trigger event occurs and all the applicable trigger criteria have been met). A corresponding pop-up message ("Waiting for trigger") is generated if no trigger signal appears after approximately 2 sec. This message goes away when a trigger signal appears.

Instrument S/W Revision: Prior to A.02.00

Trigger Level

Sets the value where the external 2 trigger input will trigger a new sweep/measurement.

Remote Command:	:TRIGger[:SEquence]:EXTernal2:LEVel :TRIGger[:SEquence]:EXTernal2:LEVel?
Example:	TRIG:EXT2:LEV 1.1 V
Dependencies/Couplings:	This same level is used for the Ext2 trigger source in the Trigger menu, for the Ext2 selection in the Periodic Timer sync source (in the Trigger menu and in the Gate Source menu), and also for the Ext2 selection in the Gate Source menu.
Preset:	1.2 V
State Saved:	Saved in instrument state.
Min:	-5 V
Max:	5 V
Key Path:	Trigger, External 2
Default Unit:	V

Trigger

Instrument S/W Revision: Prior to A.02.00

Trig Slope

Controls the trigger polarity. It is set positive to trigger on a rising edge and negative to trigger on a falling edge.

Remote Command: :TRIGger[:SEquence]:EXTernal2:SLOPe POSitive|NEGative
:TRIGger[:SEquence]:EXTernal2:SLOPe?

Example: TRIG:EXT2:SLOP NEG

Dependencies/Couplings: This same slope is used in the Ext2 selection for the trigger source in the Trigger menu and for the period timer sync source (in the Trigger menu and in the Gate Source menu).

Preset: POSitive

State Saved: Saved in instrument state.

Key Path: **Trigger, External 2**

Instrument S/W Revision: Prior to A.02.00

Trig Delay

Controls a time delay during which the analyzer will wait to begin a sweep after meeting the trigger criteria. You can use negative delay to pre-trigger the instrument in time domain or FFT, but not in swept spans.

Remote Command: :TRIGger[:SEquence]:EXTernal2:DELay <time>
:TRIGger[:SEquence]:EXTernal2:DELay?
:TRIGger[:SEquence]:EXTernal2:DELay:STATe OFF|ON|0|1
:TRIGger[:SEquence]:EXTernal2:DELay:STATe?

Example: TRIG:EXT2:DEL:STAT ON
TRIG:EXT2:DEL 100 ms

Preset: Off, 1.000 us

State Saved: Saved in instrument state.

Min: -150 ms

Max: 500 ms

Key Path: **Trigger, External 2**

Default Unit: s

Instrument S/W Revision: Prior to A.02.00

RF Burst (Wideband)

Pressing this key, when it is not selected, selects the RF Burst as the trigger. A new sweep/measurement will start when an RF burst envelope signal is identified from the signal at the RF Input connector. Pressing this key, when it is already selected, accesses the RF Burst trigger setup menu.

Example:	TRIG:SOUR RFB	Swept SA measurement
	TRIG:<meas>:SOUR RFB	Measurements other than Swept SA
Key Path:	Trigger	
State Saved:	Saved in instrument state.	
SCPI Status Bits/OPC Dependencies:	The Status Operation Register bit 5 "Waiting for Trigger" is set at the same time as the Sweeping or Measuring bit is set. It is cleared when the trigger actually occurs (that is, after the trigger event occurs and all the applicable trigger criteria have been met). A corresponding pop-up message ("Waiting for trigger") is generated if no trigger signal appears after approximately 2 sec. This message goes away when a trigger signal appears.	
Instrument S/W Revision:	Prior to A.02.00	

Trigger Level

Sets the trigger level for the RF burst envelope.

In some measurements, both absolute and relative burst trigger functions are available. When Relative is available, this key will display a toggle between **Abs** and **Rel** on the third line. When **Abs** is selected, the value on the key is the absolute trigger level; when **Rel** is selected, the value is the relative trigger level.

If no toggle appears on the key, the measurement only supports absolute trigger level.

The relative RF Burst trigger is implemented as follows:

The measurement starts with the absolute RF Burst trigger setting. If it can not get a trigger with that level, auto trigger fires and the acquisition starts anyway. After the acquisition, the measurement searches for the peak in the acquired waveform and saves it.

Now, in the next cycle of the measurement, the measurement determines a new absolute RF Burst level based on the peak value from the first measurement and the Relative RF Burst Trigger Level (always 0 or negative dB) set by you. The following formula is used:

absolute RF Burst level = peak level of the previous acquisition + relative RF Burst level

If the new absolute RF Burst level differs from the previous by more than 0.5 dB, the new level is sent to the hardware; otherwise it is not updated (to avoid slowing down the acquisition)

Trigger

Steps 2 and 3 repeat for subsequent measurements.

Remote Command: :TRIGger[:SEQuence]:RFBurst:LEVel:ABSolute <ampl>
 :TRIGger[:SEQuence]:RFBurst:LEVel:RELative <ampl>
 :TRIGger[:SEQuence]:RFBurst:LEVel:ABSolute?
 :TRIGger[:SEQuence]:RFBurst:LEVel:RELative?
 :TRIGger[:SEQuence]:RFBurst:LEVel:TYPE
 ABSolute|RELative
 :TRIGger[:SEQuence]:RFBurst:LEVel:TYPE?

Example: TRIG:RFB:LEV:ABS 10 dBm sets the trigger level of the RF burst envelope signal to the absolute level of 10 dBm.

Dependencies/Couplings: This same level is used for the RF Burst trigger source in the Trigger menu, for the RF Burst selection in the Periodic Timer sync source (in the Trigger menu and in the Gate Source menu), and also for the RF Burst selection in the Gate Source menu.

Preset: Absolute: -20 dBm
 Relative: -6 dB
 GSM: -25 dB
 ABSolute

State Saved: Saved in instrument state.

Min: Absolute: -200 dBm
 Relative: -45 dB

Max: Absolute: 100 dBm
 Relative: 0 dB

Key Path: **Trigger, RF Burst**

Default Unit: Absolute: depends on the current selected Y-Axis unit
 Relative: dB or dBc

Instrument S/W Revision: Prior to A.02.00

Trigger Slope

It is set positive to trigger on a rising edge and negative to trigger on a falling edge.

Remote Command: :TRIGger[:SEQuence]:RFBurst:SLOPe POSitive|NEGative
 :TRIGger[:SEQuence]:RFBurst:SLOPe?

Example: TRIG:RFB:SLOP NEG

Dependencies/Couplings:	This same slope is used in the RF Burst selection for the trigger source in the Trigger menu and for the period timer sync source (in the Trigger menu and in the Gate Source menu).
Preset:	POSitive
State Saved:	Saved in instrument state.
Key Path:	Trigger, RF Burst
Instrument S/W Revision:	Prior to A.02.00

Trig Delay

Controls a time delay during which the analyzer will wait to begin a sweep after meeting the trigger criteria. You can use negative delay to pre-trigger the instrument in time domain or FFT, but not in swept spans.

Remote Command:

```
:TRIGger[:SEquence]:RFBurst:DElay <time>
:TRIGger[:SEquence]:RFBurst:DElay?
:TRIGger[:SEquence]:RFBurst:DElay:STATe OFF|ON|0|1
:TRIGger[:SEquence]:RFBurst:DElay:STATe?
```

Example:

```
TRIG:RFB:DEL:STAT ON
TRIG:RFB:DEL 100 ms
```

Preset:	Off, 1.000 us
State Saved:	Saved in instrument state.
Min:	-150 ms
Max:	500 ms
Key Path:	Trigger, RF Burst
Default Unit:	s
Instrument S/W Revision:	Prior to A.02.00

Periodic Timer (Frame Trigger)

Pressing this key, when it is not selected, selects the internal periodic timer signal as the trigger. Triggering occurrences are set by the **Period** parameter, which is modified by the **Sync Source** and **Offset**. Pressing this key, when it is already selected, accesses the periodic timer trigger setup functions.

If you do not have a sync source selected (it is Off), then the internal timer will not be synchronized with any external timing events.

Example:	TRIG:SOUR FRAM	Swept SA measurement
	TRIG:<meas>:SOUR FRAM	Measurements other than Swept SA
State Saved:	Saved in instrument state.	

Trigger

Key Path:	Trigger
Readback:	[Sync: <value of Sync Source>], for example, [Sync: External 1]
SCPI Status Bits/OPC Dependencies:	The Status Operation Register bit 5 "Waiting for Trigger" is set at the same time as the Sweeping or Measuring bit is set. It is cleared when the trigger actually occurs (that is, after the trigger event occurs and all the applicable trigger criteria have been met). A corresponding pop-up message ("Waiting for trigger") is generated if no trigger signal appears after approximately 2 sec. This message goes away when a trigger signal appears.

Instrument S/W Revision: Prior to A.02.00

Periodic Timer Triggering:

This feature selects the internal periodic timer signal as the trigger. Trigger occurrences are set by the **Periodic Timer** parameter, which is modified by the **Sync Source** and **Offset**.

The figure below shows the action of the periodic timer trigger. Before reviewing the figure, we'll explain some uses for the periodic trigger.

A common application is measuring periodic burst RF signals for which a trigger signal is not easily available. For example, we might be measuring a TDMA radio which bursts every 20 ms. Let's assume that the 20 ms period is very consistent. Let's also assume that we do not have an external trigger source available that is synchronized with the period, and that the signal-to-noise ratio of the signal is not high enough to provide a clean RF burst trigger at all of the analysis frequencies. For example, we might want to measure spurious transmissions at an offset from the carrier that is larger than the bandwidth of the RF burst trigger. In this application, we can set the Periodic Timer to a 20.00 ms period and adjust the offset from that timer to position our trigger just where we want it. If we find that the 20.00 ms is not exactly right, we can adjust the period slightly to minimize the drift between the period timer and the signal to be measured.

A second way to use this feature would be to use **Sync Source** temporarily, instead of **Offset**. In this case, we might tune to the signal in a narrow span and use the RF Burst trigger to synchronize the periodic timer. Then we would turn the sync source off so that it would not mis-trigger. Mis-triggering can occur when we are tuned so far away from the RF burst trigger that it is no longer reliable.

A third example would be to synchronize to a signal that has a reference time element of much longer period than the period of interest. In some CDMA applications, it is useful to look at signals with a short periodicity, by synchronizing that periodicity to the "even-second clock" edge that happens every two seconds. Thus, we could connect the even-second clock trigger to Ext1 and use then Ext1 as the sync source for the periodic timer.

The figure below illustrates this third example. The top trace represents the even-second clock. It causes the periodic timer to synchronize with the leading edge shown. The analyzer trigger occurs at a time delayed by the accumulated offset from the period trigger event. The periodic timer continues to run, and triggers continue to occur, with a periodicity determined by the analyzer time base. The timer output (labeled "late event") will drift away from its ideal time due to imperfect matching between the time base of the signal being measured and the time base of the analyzer, and also because of imperfect setting of the period parameter. But the synchronization is restored on the next even-second clock event.

("Accumulated offset" is described in the in the **Offset** function section.)

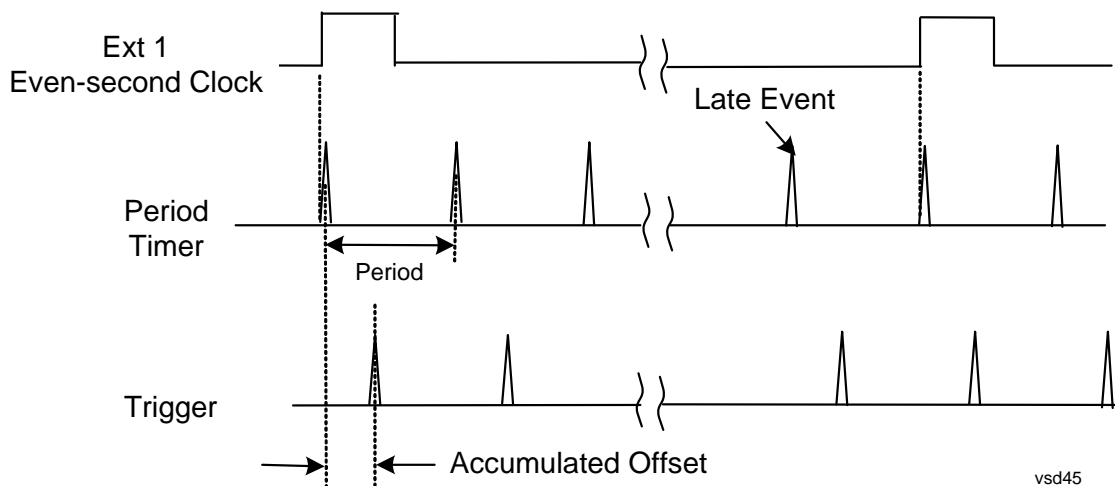

Period

Sets the period of the internal periodic timer clock. For digital communications signals, this is usually set to the frame period of your current input signal. In the case that sync source is not set to OFF, and the external sync source rate is changed for some reason, the periodic timer is synchronized at the every external synchronization pulse by resetting the internal state of the timer circuit.

Remote Command: :TRIGger[:SEquence]:FRAMe:PERiod <time>
 :TRIGger[:SEquence]:FRAMe:PERiod?

Example: TRIG:FRAM:PER 100 ms

Dependencies/Couplings: The invalid data indicator turns on when the period is changed, until the next sweep/measurement completes.

The same period is used in the Gate Source selection of the period timer.

Preset: 20 ms
 GSM: 4.615383

State Saved: Saved in instrument state.

Min: 100.000 ns

Max: 559.0000 ms

Key Path: **Trigger, Periodic Timer**

Default Unit: S

Instrument S/W Revision: Prior to A.02.00

Offset

Adjusts the accumulated offset between the periodic timer events and the trigger event. Adjusting the accumulated offset is different than setting an offset, and requires explanation.

The periodic timer is usually not synchronized with any external events, so the timing of its output events has no absolute meaning. Since the timing relative to external events (RF signals) is important,

Trigger

you need to be able to adjust (offset) it. However, you have no direct way to see when the periodic timer events occur. All that you can see is the trigger timing. When you want to adjust the trigger timing, you will be changing the internal offset between the periodic timer events and the trigger event. Because the absolute value of that internal offset is unknown, we will just call that the accumulated offset. Whenever the Offset parameter is changed, you are changing that accumulated offset. You can reset the displayed offset using Reset Offset Display. Changing the display does not change the value of the accumulated offset, and you can still make additional changes to accumulated offset.

To avoid ambiguity, we define that an increase in the "offset" parameter, either from the knob or the SCPI adjust command, serves to delay the timing of the trigger event.

Remote Command:	<code>:TRIGger[:SEquence]:FRAMe:OFFSet <time></code> <code>:TRIGger[:SEquence]:FRAMe:OFFSet?</code>
Example:	TRIG:FRAM:OFFS 1.2 ms
Dependencies/Couplings:	The invalid data indicator turns on when the offset is changed, until the next sweep/measurement completes. The same offset is used in the Gate Source selection of the period timer.
Remote Command Notes:	When the SCPI command is sent the value shown on the key (and the Active Function, if this happens to be the active function) is updated with the new value. However, the actual amount sent to the hardware is the delta value, that is, the current accumulated offset value minus the previous accumulated offset value. The SCPI query simply returns the value currently showing on the key.
Preset:	0 s
State Saved:	Saved in instrument state.
Min:	-10.000 s
Max:	10.000 s
Key Path:	Trigger, Periodic Timer
Default Unit:	S
Instrument S/W Revision:	Prior to A.02.00

Offset Adjust (Remote Command only) This remote command does not work at all like the related front-panel keys. This command lets you advance the phase of the frame trigger by the amount you specify.

It does not change the period of the trigger waveform. If the command is sent multiple times, it advances the phase of the frame trigger an additional amount each time it is sent. Negative numbers are permitted.

Remote Command:	<code>:TRIGger[:SEquence]:FRAMe:ADJust <time></code>
Example:	TRIG:FRAM:ADJ 1.2 ms

Dependencies/Couplings:	The invalid data indicator turns on when the offset is changed, until the next sweep/measurement completes. The same offset is used in the Gate Source selection of the period timer.
Remote Command Notes:	The front panel interface (for example, the knob) and the :TRIG:FRAM:OFFS command adjust the accumulated offset, which is shown on the active function display. However, the actual amount sent to the hardware is the delta value, that is, the current offset value minus the previous offset value. When the SCPI command is sent the value shown on the key (and the Active Function, if this happens to be the active function) is updated by increasing it (or decreasing it if the value sent is negative) by the amount specified in the SCPI command. This is a "command only" SCPI command, with no query.
Preset:	0 s
State Saved:	Saved in instrument state.
Min:	-10.000 s
Max:	10.000 s
Default Unit:	S
Instrument S/W Revision:	Prior to A.02.00

Reset Offset Display

Resets the value of the periodic trigger offset display setting to 0.0 seconds. The current displayed trigger location may include an offset value defined with the **Offset** key. Pressing this key redefines the currently displayed trigger location as the new trigger point that is 0.0 s offset. The **Offset** key can then be used to add offset relative to this new timing.

Remote Command:	:TRIGger[:SEquence]:FRAMe:OFFSet:DISPlay:RESet
Example:	TRIG:FRAM:OFFS:DISP:RES
Key Path:	Trigger, Periodic Timer
Instrument S/W Revision:	Prior to A.02.00

Sync Source

Selects a signal source for you to synchronize your periodic timer trigger to, otherwise you are triggering at some arbitrary location in the frame. Synchronization reduces the precision requirements on the setting of the period.

For convenience you may adjust the level and slope of the selected sync source in a conditional branch setup menu accessed from the Sync Source menu. Note that these settings match those in the **Trigger** and **Gate Source** menus; that is, each trigger source has only one value of level and slope, regardless of

Trigger

which menu it is accessed from.

Remote Command: :TRIGger[:SEquence]:FRAMe:SYNC
EXTernal1|EXTernal2|RFBurst|OFF
:TRIGger[:SEquence]:FRAMe:SYNC?

Example: TRIG:FRAM:SYNC EXT2

Preset: Off
GSM/EDGE: RFBurst

State Saved: Saved in instrument state.

Key Path: **Trigger, Periodic Timer**

Readback: The current setting is read back to this key and it is also Readback to the previous **Periodic Timer** trigger key.

Instrument S/W Revision: Prior to A.02.00

Off Turns off the sync source for your periodic trigger. With the sync source off, the timing will drift unless the signal source frequency is locked to the analyzer frequency reference.

Example: TRIG:FRAM:SYNC OFF

Key Path: **Trigger, Periodic Timer, Sync Source**

Readback: Off

Instrument S/W Revision: Prior to A.02.00

External 1 Pressing this key, when it is not selected, selects the external input port that you will use for the periodic trigger synchronization. Pressing this key, when it is already selected, accesses the external 1 sync source setup menu.

Example: TRIG:FRAM:SYNC EXT

Dependencies/Couplings: Same as External 1 trigger source.

Key Path: **Trigger, Periodic Timer, Sync Source**

Readback: External 1

Instrument S/W Revision: Prior to A.02.00

External 2 Pressing this key, when it is not selected, selects the external input port that you will use for the periodic frame trigger synchronization.

Pressing this key, when it is already selected, accesses the external 2 sync source setup menu.

Example: TRIG:FRAM:SYNC EXT2

Dependencies/Couplings: Same as External 2 trigger source.

Key Path: **Trigger, Periodic Timer, Sync Source**
 Readback: External 2
 Instrument S/W Revision: Prior to A.02.00

RF Burst (Wideband) Pressing the key once selects the RF burst envelope signal to be used for the periodic timer trigger synchronization.

Press the key a second time to access the RF burst sync source setup menu.

Example: TRIG:FRAM:SYNC RFB
 Dependencies/Couplings: Same as RF Burst trigger source.
 Key Path: **Trigger, Periodic Timer, Sync Source**
 Readback: RF Burst
 Instrument S/W Revision: Prior to A.02.00

Trig Delay

This setting delays the measurement timing relative to the Periodic Timer.

Remote Command: :TRIGger[:SEQuence]:FRAMe:DELay <time>
 :TRIGger[:SEQuence]:FRAMe:DELay?
 :TRIGger[:SEQuence]:FRAMe:DELay:STATe OFF|ON|0|1
 :TRIGger[:SEQuence]:FRAMe:DELay:STATe?

Preset: Off, 1.000 us
 State Saved: Saved in instrument state.
 Min: -150 ms
 Max: +500 ms
 Key Path: **Trigger, Periodic Timer**
 Default Unit: s
 Instrument S/W Revision: Prior to A.02.00

Sync Holdoff

Sync Holdoff specifies the duration that the sync source signal must be kept false before the transition to true to be recognized as the sync timing. The periodic timer phase is aligned when the sync source signal becomes true, after the Holdoff time is satisfied.

A holdoff of 2 ms will work with most WiMAX signals, but there may be cases where the burst off

Trigger

duration is less than 1 ms and this value will need to be changed.

Remote Command:	:TRIGger[:SEquence]:FRAME:SYNC:HOLDoff <time> :TRIGger[:SEquence]:FRAME:SYNC:HOLDoff? :TRIGger[:SEquence]:FRAME:SYNC:HOLDoff:STATE OFF ON 0 1 :TRIGger[:SEquence]:FRAME:SYNC:HOLDoff:STATE?
Preset:	On, 1.000 ms
State Saved:	Saved in instrument state.
Min:	0 ms
Max:	+500 ms
Key Path:	Trigger, Periodic Timer
Default Unit:	s
Instrument S/W Revision:	Prior to A.02.00

LXI Trigger

Pressing this key when it is not selected selects the LXI system as the trigger. Pressing the key when it is already selected accesses the LXI trigger type selection menu, where either LAN Event or Alarm can be chosen. The key is annotated to display which of the two is currently selected.

NOTE	For information about setting up measurements using LXI, refer to the Programmer's Guide located in your analyzer at: C:/Program Files/Agilent/Signal Analysis/Help/Bookfiles/x_series_prog.pdf. It is also available by selecting the "Additional Documentation" page of the Help.
-------------	---

Key Path	Trigger
Mode	SA, IQ(Basic)
Preset	ON
State Saved	Saved in instrument state.
Readback	The LXI trigger source that becomes active when this key is selected is displayed. The possible values are "LAN Event" and "Alarm"
Instrument S/W Revision	Prior to A.02.00

LAN Event

Pressing this key when it is not selected selects the LAN event system as the LXI trigger. A new sweep/measurement starts when the pre-configured LAN message arrives if the LXI trigger is selected (see "[LXI Trigger](#)" on page 1278). Pressing this key when it is already selected accesses the LAN

trigger setup menu.

NOTE Pressing this button causes Enabled LXI Alarm Triggers to be ignored, since the Trigger source is changed to LXI LAN Event

Example	TRIG:SOUR LAN Swept SA measurement TRIG:<meas>:SOUR LAN Measurements other than Swept SA
SCPI Status Bits/OPC Dependencies	The Status Operation Register bit 5 "Waiting for Trigger" is set at the same time as the Sweeping or Measuring bit is set. It is cleared when the trigger actually occurs (that is, after the trigger event occurs and all the applicable trigger criteria have been met). A corresponding pop-up message ("Waiting for trigger") is generated if no trigger signal appears after approximately 2 sec. This message goes away when a trigger signal appears.
Key Path	Trigger, LXI Trigger
Mode	SA, IQ(Basic)
Preset	ON
State Saved	Saved in instrument state.
State Saved	Saved in instrument state.
Instrument S/W Revision	Prior to A.02.00

Disable All Sets the Enable parameter of every member of the LXI LAN Event list to OFF.

Remote Command	:TRIGger[:SEquence]:LXI:LAN:DISable:ALL
Example	:TRIG:LXI:LAN:DIS:ALL
Key Path	Trigger LXI Trigger, LAN Event
Mode	SA, IQ(Basic)
Instrument S/W Revision	Prior to A.02.00

LAN Event List After selecting LAN as the trigger source, you are presented with a list of LXI Trigger LAN Events to be configured. By default, LAN0-LAN7 are available. Using the TRIG:LXI:LAN:ADD and TRIG:LXI:LAN:REM commands, the size of this list can be changed arbitrarily. Pressing a LAN event branches to that event's setup menu.

Remote Command	:TRIGger[:SEquence]:LXI:LAN:LIST?
Example	:TRIG:LXI:LAN:LIST? Returns the complete list of Trigger LAN Events which is, at minimum: "LAN0", "LAN1", "LAN2", "LAN3", "LAN4", "LAN5", "LAN6", "LAN7"

Trigger

Key Path	Trigger LXI Trigger, LAN Event
Mode	SA, IQ(Basic)
Preset	"LAN0", "LAN1", "LAN2", "LAN3", "LAN4", "LAN5", "LAN6", "LAN7"
State Saved	Saved in instrument state.
Readback	Displays the value of the LXI Trigger LAN Event parameter (Enabled Disabled).
Instrument S/W Revision	Prior to A.02.00

Detection Pressing this button brings up the Trigger Detection menu.

Selecting "Rise" causes the instrument to trigger on the receipt of a signal low LAN Event followed by a signal high LAN Event.

Selecting "Fall" caused the instrument to trigger on the receipt of a signal high LAN Event followed by a signal low LAN Event.

Selecting "High" causes the instrument to trigger on every signal high LAN Event.

Selecting "Low" causes the instrument to trigger on every signal low LAN Event.

Remote Command	:TRIGger[:SEQuence]:LXI:LAN[:SET]:DETection "LANEVENT", HIGH LOW RISE FALL
Example	:TRIG:LXI:LAN:DET "LAN0",HIGH
Restriction and Notes	If a non existent LAN event is passed in the lanEvent argument, the command is ignored
Key Path	Trigger LXI Trigger, LAN Event, <lanEvent>
Mode	SA, IQ(Basic)
Preset	HIGH
State Saved	Saved in instrument state.
Range	HIGH LOW RISE FALL
Readback	Currently selected detection type
Instrument S/W Revision	Prior to A.02.00

Remote Command	:TRIGger[:SEQuence]:LXI:LAN[:SET]:DETection? "LANEVENT"
Example	:TRIG:LXI:LAN:DET? "LAN0"?
Restriction and Notes	If a non existent LAN event is passed in the lanEvent argument, the command is ignored
Key Path	Trigger LXI Trigger, LAN Event, <lanEvent>
Mode	SA, IQ(Basic)
Preset	HIGH

State Saved	Saved in instrument state.
Range	HIGH LOW RISE FALL
Readback	Currently selected detection type
Instrument S/W Revision	Prior to A.02.00

Delay Sets the amount of delay that should pass between receiving a LXI Trigger LAN Event Trigger and the trigger action. A Delay of 0.0 s indicates that the instrument will trigger as soon as possible after receiving the proper LXI LAN Event.

Remote Command	:TRIGger[:SEquence]:LXI:LAN[:SET]:DElay "LANEVENT", <time>
Example	:TRIG:LXI:LAN:DEL "LAN0",5S
Key Path	Trigger, LXI Trigger, LAN Event, <lanEvent>
Mode	SA, IQ(Basic)
Preset	0.0 s
State Saved	Saved in instrument state.
Range	0.0 – 1.7976931348623157 x 10308 (Max Double)
Instrument S/W Revision	Prior to A.02.00

Remote Command	:TRIGger[:SEquence]:LXI:LAN[:SET]:DElay? "lanEvent "
Example	:TRIG:LXI:LAN:DEL? "LAN0"
Key Path	Trigger, LXI Trigger, LAN Event, <lanEvent>
Mode	SA, IQ(Basic)
Preset	0.0 s
State Saved	Saved in instrument state.
Range	0.0 – 1.7976931348623157 x 10308 (Max Double)
Instrument S/W Revision	Prior to A.02.00

Enabled/Disabled When the Trigger Source is set to LXI Trigger LAN Event, the instrument triggers upon receiving any event from the LXI Trigger LAN Event List whose Enabled parameter is set to ON.

If the Enabled parameter is set to OFF, the event is ignored.

Remote Command	:TRIGger[:SEquence]:LXI:LAN[:SET]:ENABled "LANEVENT", ON OFF 1 0
Example	:TRIG:LXI:LAN:ENAB "LAN0",ON
Key Path	Trigger, LXI Trigger, LAN Event, <lanEvent>

Trigger

Mode	SA, IQ(Basic)
Preset	OFF
State Saved	Saved in instrument state.
Range	OFF ON 0 1
Instrument S/W Revision	Prior to A.02.00

Remote Command :TRIGger [:SEquence] :LXI :LAN [:SET] :ENABled? "LANEVENT"

Example :TRIG:LXI:LAN:ENAB? "LAN0"

Key Path **Trigger, LXI Trigger, LAN Event, <lanEvent>**

Mode	SA, IQ(Basic)
Preset	OFF
State Saved	Saved in instrument state.
Range	OFF ON 0 1
Instrument S/W Revision	Prior to A.02.00

Add (Remote Only) Adds the provided string to the list of possible LAN events to trigger on. As new LAN events are added, keys are generated in the LAN source menu. New key panels are generated as the number of possible LAN events increases past a multiple of six, and the "More" keys are updated to reflect the new number of key panels in the LAN source menu.

Remote Command :TRIGger [:SEquence] :LXI :LAN :ADD "LANEVENT"

Example :TRIG:LXI:LAN:ADD "LANEVENT"

Restriction and Notes
The maximum length of the string is 16 characters.
Longer strings are concatenated to 16 characters and added.
No event is added if the LAN Event already exists.
This command modifies the LXI Trigger LAN Event List Parameter.

Mode	SA, IQ(Basic)
State Saved	No
Range	Uppercase, Lowercase, Numeric, Symbol except for comma or semicolon
Instrument S/W Revision	Prior to A.02.00

Remove (Remote Only) Removes the provided string from the list of possible LAN events to trigger on. As LAN events are removed, keys are removed from the LAN source menu. Key panels are removed as the number of possible LAN events decreases past a multiple of six, and the "More" keys are updated to reflect the new number of key panels in the LAN source menu. It is not possible to remove the

"LAN0" – "LAN7" events.

Remote Command	:TRIGger [:SEquence] :LXI :LAN :REMove [:EVENT] "LANEVENT"
Example	:TRIG:LXI:LAN:REM "LANEVENT"
Restriction and Notes	The maximum length of the string is 16 characters. Longer strings are concatenated and the corresponding LAN Event is removed. Nothing happens if the LAN event does not exist. This command modifies the LXI Trigger LAN Event List Parameter.
Mode	SA, IQ(Basic)
State Saved	No
Range	Uppercase, Lowercase, Numeric, Symbol except for comma or semicolon
Instrument S/W Revision	Prior to A.02.00

Remove All (Remote Only) Clears the list of customer added LAN events that can cause the instrument to trigger. Events LAN0-LAN7 are not affected. As LAN events are removed, keys are removed from the LAN source menu. Key panels are removed as the number of possible LAN events decreases past a multiple of six, and the "More" keys are updated to reflect the new number of key panels in the LAN source menu.

It is not possible to remove the "LAN0" – "LAN7" events.

Remote Command	:TRIGger [:SEquence] :LXI :LAN :REMove :ALL
Example	:TRIG:LXI:LAN:REM:ALL
Restriction and Notes	This command modifies the LXI Trigger LAN Event List Parameter.
Mode	SA, IQ(Basic)
Instrument S/W Revision	Prior to A.02.00

Event Filter (Remote Only) Only LXI Trigger LAN Events coming from hosts matching the filter string are processed. There is no front panel access to this command

The syntax for specifying a filter is as follows:

Filter == ([host[:port]] | [ALL[:port]]) [,Filter]

Specifying an empty string means that LXI trigger packets are accepted as a Trigger from any port on any host on the network via either TCP or UDP.

Specifying only the port means that any host communicating over that port can send events.

Specifying ALL indicates that UDP multicast packets are accepted if they are directed to the Internet Assigned Numbers Authority (IANA) assigned multicast address on the IANA assigned default port, or the designated port if specified.

Examples:

Trigger

"192.168.0.1:23"

"agilent.com, soco.agilent.com"

"agilent.com:80, 192.168.0.1"

Remote Command :TRIGger[:SEquence]:LXI:LAN[:SET]:FILTer
"LANEVENT", "filterString"
:TRIGger[:SEquence]:LXI:LAN[:SET]:FILTer?

Example :TRIG:LXI:LAN:FILT "LAN0","agilent.com"
:TRIG:LXI:LAN:FILT?

Restriction and Notes The maximum length of the string is 45 characters. Nothing happens if the LAN event does not exist.

Mode SA, IQ(Basic)

Preset "" (empty string)

State Saved Saved in instrument state.

Range Uppercase, Lowercase, Numeric, Symbol

Instrument S/W Revision Prior to A.02.00

Count (Remote Only) Returns the number of items in the LXI Trigger LAN Event List.

Remote Command :TRIGger[:SEquence]:LXI:LAN:COUNT?

Example :TRIG:LXI:LAN:COUN?

Mode SA, IQ(Basic)

Instrument S/W Revision Prior to A.02.00

Identifier (Remote Only) Sets the string that is expected to arrive over the LAN for a given Trigger LAN Event to occur. The Identifier is variable to allow for easier system debugging.

Remote Command :TRIGger[:SEquence]:LXI:LAN[:SET]:IDENtifier
"LANEVENT", "identifier"
:TRIGger[:SEquence]:LXI:LAN[:SET]:IDENtifier?
"LANEVENT"

Example :TRIG:LXI:LAN:IDEN "LAN0","debugstring"

Restriction and Notes The maximum length of the string is 16 characters.

Nothing happens if the LAN event does not exist.

The default value is that the identifier is equivalent to the name of the LAN Event.

Mode SA, IQ(Basic)

State Saved Saved in instrument state.

Range	Uppercase, Lowercase, Numeric, Symbol
Instrument S/W Revision	Prior to A.02.00

Configure (Remote Only) Allows the configuration of some of the above parameters from a single SCPI command.

Remote Command	:TRIGger[:SEquence]:LXI:LAN[:SET]:CONFigure "lanEvent", <enable>, <detection>, <delay>, <filter>, <identifier>
Example	:TRIG:LXI:LAN:CONF "LAN0",1,FALL,0.0,"ALL","debugIdentifier"
Mode	SA, IQ(Basic)
Instrument S/W Revision	Prior to A.02.00

Alarm

Pressing this key when it is not selected selects the alarm system as the LXI trigger. A new sweep/measurement starts when the configured IEEE 1588 time occurs if the LXI trigger is selected as the active trigger (see "[LXI Trigger](#)" on page 1278). Pressing this key when it is already selected accesses the alarm source selection menu.

Example	TRIG:ACP:SOUR ALAR
SCPI Status Bits/OPC Dependencies	The Status Operation Register bit 5 "Waiting for Trigger" is set at the same time as the Sweeping or Measuring bit is set. It is cleared when the trigger actually occurs (that is, after the trigger event occurs and all the applicable trigger criteria have been met). A corresponding pop-up message ("Waiting for trigger") is generated if no trigger signal appears after approximately 2 sec. This message goes away when a trigger signal appears.
Key Path	Trigger LXI Trigger
Mode	SA, IQ(Basic)
Preset	ON
State Saved	Saved in instrument state.
Instrument S/W Revision	Prior to A.02.00

Disable All This key causes all Alarms in the trigger alarm list to go into the disabled state. (Enabled = OFF)

Remote Command	:TRIGger[:SEquence]:LXI:ALARm:DISable:ALL
Example	:TRIG:LXI:ALAR:DIS:ALL
Key Path	Trigger, LXI Trigger, Alarm
Mode	SA, IQ(Basic)
Instrument S/W Revision	Prior to A.02.00

Trigger

Alarm List After selecting Alarm as the trigger source, you are presented with a list of possible alarms. Pressing an alarm (e.g. "ALARM0") branches to the alarm setup menu.

Remote Command	:TRIGger [:SEQuence] :LXI :ALARm :LIST?
Example	:TRIG:LXI:ALAR:LIST? Returns the complete list of Alarm events which is: "ALARM0"
Key Path	Trigger, LXI Trigger, Alarm
Mode	SA, IQ(Basic)
Preset	"ALARM0"
State Saved	Saved in instrument state.
Readback	Displays the value of the LXI Trigger Alarm Enabled parameter (Enabled Disabled).
Instrument S/W Revision	Prior to A.02.00

Date/Time Absolute alarm time sets an alarm for one specific time using the date and time of day (e.g. 12/14/2007 at 11:45:15.3456). The Date and Time are represented in the instrument's local time. This is the only way to set an alarm from the front panel.

Epoch time is another type of absolute alarm time. A specific time is identified by the number of seconds it occurs after January 1, 1970 00:00:00 in International Atomic Time (TAI). Epoch Time is time zone invariant. Epoch time is only set via remote; see ["Epoch Time Value \(Remote Only\)" on page 1289](#).

The date and time the alarm is scheduled to go off is noted on the branch key.

NOTE The Epoch Time Second and Epoch Time Fraction are the ultimate source of alarm information. The Absolute Time and Date may be changed from the front panel without being applied. When querying the Absolute Time and Date parameters from SCPI, if the Absolute Time and Date have not been applied (and therefore do not match the Epoch Time Second and Epoch Time Fraction), the string "(epoch time not set)" is added to the return value.

Key Path	Trigger, LXI Trigger, Alarm, <alarmEvent>
Mode	SA, IQ(Basic)
Readback	Annotated with the date and time the alarm is scheduled to go off.
Instrument S/W Revision	Prior to A.02.00
Remote Command	:TRIGger [:SEQuence] :LXI :ALARm [:SET] :TIME [:VALue] :ABSolu te "alarmEvent", "date", "time"
Example	:TRIG:LXI:ALAR:TIME:ABS "ALARM0", "2007/4/6", "15:45:02.123456"

Remote Command Notes	<p>"date" is a representation of the date the alarm should occur in the form of "YYYY/MM/DD" where:</p> <p>YYYY is the four digit representation of year. (for example, 2007)</p> <p>MM is the two digit representation of month. (for example. 01 to 12)</p> <p>DD is the two digit representation of day. (for example, 01 to 28, 29, 30, or 31 depending on the month and year)</p> <p>"time" is a representation of the time of day the alarm should occur in the form of "HH:MM:SS.SSSSSS" where:</p> <p>HH is the two digit representation of the hour in 24 hour format</p> <p>MM is the two digit representation of minute</p> <p>SS.SSSSSS is a real representing seconds (for example 02.123456)</p>
Key Path	Trigger, LXI Trigger, Alarm, <alarmEvent>,Time
Mode	SA, IQ(Basic)
Preset	Current date at initialization at 00:00:00.000000
State Saved	Saved in instrument state.
Instrument S/W Revision	Prior to A.02.00
Remote Command	:TRIGger[:SEquence]:LXI:ALARm[:SET]:TIME[:VALue]:ABSolute? "alarmEvent"
Example	<p>:TRIG:LXI:ALAR:TIME:ABS? "ALARM0"</p> <p>This query returns data using the following format "YYYY/MM/DD HH:MM:SS.SSSSSS" If the Absolute time has been changed from the front panel, but has not been applied, the return value is of the form "YYYY/MM/DD HH:MM:SS.SSSSSS (epoch time not set)".</p>
Remote Command Notes	<p><date> is a representation of the date the alarm should occur in the form of YYYY/MM/DD where:</p> <p>YYYY is the four digit representation of year. (for example, 2007)</p> <p>MM is the two digit representation of month. (for example. 01 to 12)</p> <p>DD is the two digit representation of day. (for example, 01 to 28, 29, 30, or 31 depending on the month and year)</p> <p><time> is a representation of the time of day the alarm should occur in the form of HH:MM:SS.SSSSSS where:</p> <p>HH is the two digit representation of the hour in 24 hour format</p> <p>MM is the two digit representation of minute</p> <p>SS.SSSSSS is a real representing seconds (for example 02.123456)</p>
Key Path	Trigger, LXI Trigger, Alarm, <alarmEvent>,Time
Mode	SA, IQ(Basic)

Trigger

Preset	Current date at initialization at 00:00:00.000000
State Saved	Saved in instrument state.
Instrument S/W Revision	Prior to A.02.00

Date The date the alarm should occur. All absolute alarm time parameters are set using the same SCPI command; however they each have their own front panel control.

When setting alarm values from the front panel, the new alarm time is not registered with the alarm system until the "Set" key is pressed.

Key Path	Trigger, LXI Trigger, Alarm, <alarmEvent>,Time
Mode	SA, IQ(Basic)
Preset	Current date
State Saved	Saved in instrument state.
Range	current date – 214748/12/31. Values representing a time in the past result in an error.
Instrument S/W Revision	Prior to A.02.00

Time The time of the day, in the instrument's local time (this takes into account time zones and daylight savings time), the alarm should occur. This parameter is based on a 24 hour clock.

All absolute alarm time parameters are set using the same SCPI command; however they each have their own front panel control.

When setting alarm values from the front panel, the new alarm time is not registered with the alarm system until the "Set" key is pressed.

Restriction and Notes	Uses a 24 hour clock. Values representing a time in the past result in an error. Only valid time values are accepted. The <second> field accepts a decimal number, and is valid to the microsecond position. The <year>, <month>, <hour>, and <minute> fields all accept integers.
-----------------------	--

Key Path	Trigger, LXI Trigger, Alarm, <alarmEvent>,Time
Mode	SA, IQ(Basic)
Preset	00:00:00.000000
State Saved	Saved in instrument state.
Range	00:00:00.000000 – 23:59:59.999999
Instrument S/W Revision	Prior to A.02.00

Apply (Front Panel Only) Causes the Absolute Alarm Time values to be converted into an Epoch time (see [“Epoch Time Value \(Remote Only\)” on page 1289](#)), compared to the current time, and sent to the Alarm Trigger

subsystem. This key can only be pressed when the epoch time and the absolute time are out of synch.

Restriction and Notes	Alarm times are settable to microsecond resolution.
Key Path	Trigger, LXI Trigger, Alarm, <alarmEvent>,Time
Mode	SA, IQ(Basic)
Instrument S/W Revision	Prior to A.02.00

Epoch Time Value (Remote Only) Sets the LXI Alarm Time. This represents the number of seconds after January 1, 1970 00:00:00, in TAI time, that the alarm should go off.

Remote Command	:TRIGger[:SEQuence]:LXI:ALARm[:SET]:TIME[:VALue] "alarmEvent", <seconds>, <fractionalSeconds>
Example	:TRIG:LXI:ALAR:TIME "ALARM0",123456.0 S, 0.123456
Restriction and Notes	Values representing a time in the past result in an error.
Mode	SA, IQ(Basic)
Preset	Seconds: The number of whole seconds between Jan 1, 1970 at 00:00:00 (in TAI time) and the current date at initialization at 00:00:00 (in TAI time) FractionalSeconds: 0
State Saved	Saved in instrument state.
Range	Seconds: Epoch time of current date at 00:00:00 (in TAI time) – 253402300800 + number of seconds local time zone offset from UTC FractionalSeconds: 0.0 – 0.999999
Instrument S/W Revision	Prior to A.02.00

Remote Command	:TRIGger[:SEQuence]:LXI:ALARm[:SET]:TIME[:VALue]?
Example	:TRIG:LXI:ALAR:TIME?
Restriction and Notes	Values representing a time in the past result in an error.
Mode	SA, IQ(Basic)
Preset	Seconds: The number of whole seconds between Jan 1, 1970 at 00:00:00 (in TAI time) and the current date at initialization at 00:00:00 (in TAI time) FractionalSeconds: 0
State Saved	Saved in instrument state.
Range	Seconds: Epoch time of current date at 00:00:00 (in TAI time) – 253402300800 + number of seconds local time zone offset from UTC FractionalSeconds: 0.0 – 0.999999
Instrument S/W Revision	Prior to A.02.00

Epoch Time Seconds (Remote only) Sets the seconds portion of the LXI Alarm time. This represents the number

Trigger

of seconds after January 1, 1970 00:00:00 (in TAI time) that the alarm should go off.

Values must be in the form of whole seconds; decimal values result in an error.

Remote Command	:TRIGger[:SEquence]:LXI:ALARm[:SET]:TIME:SEConds "alarmEvent", <seconds>
Example	:TRIG:LXI:ALAR:TIME:SEC "ALARM0",123456.0 S
Restriction and Notes	Values representing a time in the past result in an error. Values containing a decimal portion result in an error.
Mode	SA, IQ(Basic)
Preset	The number of whole seconds between Jan 1, 1970 at 00:00:00 (in TAI time) and the current date at initialization at 00:00:00 (in TAI time)
State Saved	Saved in instrument state.
Range	Epoch time of current date at 00:00:00 (in TAI time) – 253402300800 + number of seconds local time zone offset from UTC
Instrument S/W Revision	Prior to A.02.00

Remote Command	:TRIGger[:SEquence]:LXI:ALARm[:SET]:TIME:SEConds? "alarmEvent "
Example	:TRIG:LXI:ALAR:TIME:SEC "ALARM0"?
Restriction and Notes	Values representing a time in the past result in an error. Values containing a decimal portion result in an error.
Mode	SA, IQ(Basic)
Preset	The number of seconds between Jan 1, 1970 at 00:00:00 (in TAI time) and the current date at initialization at 00:00:00 (in TAI time)
State Saved	Saved in instrument state.
Range	Epoch time of current date at 00:00:00 (in TAI time) – 253402300800 + number of seconds local time zone offset from UTC
Instrument S/W Revision	Prior to A.02.00

Epoch Time Fraction (Remote Only) Sets the sub-second value of the Epoch time.

Remote Command	:TRIGger[:SEquence]:LXI:ALARm[:SET]:TIME[:VALue]:FRACti on "alarmEvent", <fractionalSeconds>
Example	:TRIG:LXI:ALAR:TIME:FRAC "ALARM0",0.123456 S
Restriction and Notes	Values representing a time in the past result in an error.
Mode	SA, IQ(Basic)
Preset	0

State Saved Saved in instrument state.

Range 0.0 – 0.999999

Instrument S/W Revision Prior to A.02.00

Remote Command :TRIGger[:SEquence]:LXI:ALARm[:SET]:TIME[:VALue]:FRACtion? "alarmEvent"

Example :TRIG:LXI:ALAR:TIME:FRAC "ALARM0"?

Restriction and Notes Values representing a time in the past result in an error.

Mode SA, IQ(Basic)

Preset 0

State Saved Saved in instrument state.

Min 0.0

Max 0.999999

Instrument S/W Revision Prior to A.02.00

Relative Time (Remote Only) Sets the values of Epoch Time Seconds and Epoch Time Fraction by adding an offset to the time when the command is issued. For example, if the Relative Time command is issued with an argument of 60s, the alarm will occur 1 minute in the future.

Remote Command :TRIGger[:SEquence]:LXI:ALARm[:SET]:TIME[:VALue]:RELative "alarmEvent", <seconds>

Example :TRIG:LXI:ALAR:TIME:REL "ALARM0",60.0s

Mode SA, IQ(Basic)

Range 0.0 – 1.7976931348623157 x 10308 (Max Double)

Instrument S/W Revision Prior to A.02.00

Remote Command :TRIGger[:SEquence]:LXI:ALARm[:SET]:TIME[:VALue]:RELative? "alarmEvent"

Example :TRIG:LXI:ALAR:TIME:REL "ALARM0"?

Mode SA, IQ(Basic)

Range 0.0 – 1.7976931348623157 x 10308 (Max Double)

Instrument S/W Revision Prior to A.02.00

Period Sets the amount of time that should elapse between alarms in a repeating alarm trigger.

Remote Command :TRIGger[:SEquence]:LXI:ALARm[:SET]:PERiod "alarmEvent", <seconds>

Trigger

Example	:TRIG:LXI:ALAR:PER "ALARM0",1.2345 s
Restriction and Notes	A period of 0.0s effectively causes the trigger to occur only once, since all repetitions are fired simultaneously
Key Path	Trigger, LXI Trigger, Alarm, <alarmEvent>
Mode	SA, IQ(Basic)
Preset	0.0 s
State Saved	Saved in instrument state.
Range	0.0 – 1.7976931348623157 x 10308 (Max Double)
Instrument S/W Revision	Prior to A.02.00

Remote Command :TRIGger[:SEquence]:LXI:ALARm[:SET]:PERiod?
"alarmEvent"

Example	:TRIG:LXI:ALAR:PER "ALARM0"?
Restriction and Notes	A period of 0.0s effectively causes the trigger to occur only once, since all repetitions are fired simultaneously
Key Path	Trigger, LXI Trigger, Alarm, <alarmEvent>
Mode	SA, IQ(Basic)
Preset	0.0 s
State Saved	Saved in instrument state.
Range	0.0 – 1.7976931348623157 x 10308 (Max Double)
Instrument S/W Revision	Prior to A.02.00

Repetitions Sets the number of times a repeating alarm should fire once the initial alarm time has occurred.

Remote Command :TRIGger[:SEquence]:LXI:ALARm[:SET]:REPeat
"alarmEvent", <repetitions>

Example	:TRIG:LXI:ALAR:REP "ALARM0",10
Key Path	Trigger, LXI Trigger, Alarm, <alarmEvent>
Mode	SA, IQ(Basic)
Preset	1
State Saved	Saved in instrument state.
Range	1 – 2,147,483,647
Instrument S/W Revision	Prior to A.02.00

Remote Command :TRIGger[:SEquence]:LXI:ALARm[:SET]:REPeat?
"alarmEvent"

Example	:TRIG:LXI:ALAR:REP "ALARM0",10
Key Path	Trigger, LXI Trigger, Alarm, <alarmEvent>
Mode	SA, IQ(Basic)
Preset	1
State Saved	Saved in instrument state.
Min	1
Max	2,147,483,647
Instrument S/W Revision	Prior to A.02.00

Enabled If Enabled is set to ON and the trigger source is set to ALARm, this alarm causes the instrument to trigger.

If Enabled is set to OFF, this alarm is ignored

Remote Command :TRIGger[:SEQuence]:LXI:ALARm[:SET]:ENABled
"alarmEvent",ON|OFF|1|0

Example	:TRIG:LXI:ALAR:ENAB "ALARM0",ON
Key Path	Trigger, LXI Trigger, Alarm, <alarmEvent>
Mode	SA, IQ(Basic)
Preset	OFF
State Saved	Saved in instrument state.
Range	1 0
Instrument S/W Revision	Prior to A.02.00

Remote Command :TRIGger[:SEQuence]:LXI:ALARm[:SET]:ENABled?
"alarmEvent"

Example	:TRIG:LXI:ALAR:ENAB "ALARM0"?
Key Path	Trigger, LXI Trigger, Alarm, <alarmEvent>
Mode	SA, IQ(Basic)
Preset	OFF
State Saved	Saved in instrument state.
Range	1 0
Instrument S/W Revision	Prior to A.02.00

Configure (Remote Only) Allows the configuration of some of the above parameters from a single SCPI

Trigger

command.

Remote Command	:TRIGger[:SEquence]:LXI:ALARm[:SET]:CONFigure "alarmEvent", <enable>, <epochSeconds>, <epochFraction>, <period>, <repeat>
Example	:TRIG:LXI:ALAR:CONF "ALARM0",1,1000000.0,0.123456,1,2,3
Mode	SA, IQ(Basic)
Instrument S/W Revision	Prior to A.02.00

Count (Remote Only) Returns the number of alarms in the LXI Trigger Alarm List.

Remote Command:	:TRIGger1 TRIGger[:SEquence]:LXI:ALARm:COUNT?
Example:	:TRIG:LXI:ALAR:COUN?
Instrument S/W Revision:	Prior to A.02.00

Baseband I/Q

Pressing this key when it is not selected selects Baseband I/Q as the trigger. Pressing the key when it is already selected accesses the Baseband I/Q trigger type selection menu. The key is annotated to display which of the Baseband I/Q trigger types is currently selected.

Key Path	Trigger
Mode	SA, IQ(Basic)
State Saved	No
Readback	The Baseband I/Q trigger source that becomes active when this key is selected is displayed. The possible values are "I/Q Mag", "I", "Q", "Input I", "Input Q", and "Aux I/Q Mag".
Instrument S/W Revision	Prior to A.02.00

I/Q Mag

Pressing this key, when it is not selected, selects the I/Q magnitude signal as the trigger. The I/Q Magnitude trigger condition is met when the I/Q magnitude crosses the I/Q magnitude trigger level. The magnitude is measured at the output of the main I/Q digital receiver.

Example	TRIG:<meas>:SOUR IQM
Key Path	Trigger, Baseband I/Q
Readback Text	I/Q Mag
Instrument S/W Revision	Prior to A.02.00

Trigger Level Sets a level for the I/Q magnitude trigger. When the signal crosses this level, with the chosen slope, the trigger occurs. If the specific Measurement displays the signal from the chosen

sampling point a green line will be displayed to indicate the trigger level.

Remote Command	:TRIGger[:SEquence]:IQMag:LEVel <ampl > :TRIGger[:SEquence]:IQMag:LEVel?
Remote Command Notes	The I/Q reference impedance is used for converting between power and voltage.
Example	TRIG:IQM:LEV -30 dBm
Key Path	Trigger, Baseband I/Q, I/Q Mag
Preset	-25 dBm
State Saved	Saved in instrument state.
Range	-200 dBm to 100 dBm
Readback Text	<level> dBm
Instrument S/W Revision	Prior to A.02.00

Trig Slope Controls the trigger polarity. It is set positive to trigger on a rising edge and negative to trigger on a falling edge.

Remote Command	:TRIGger[:SEquence]:IQMag:SLOPe POSitive NEGative :TRIGger[:SEquence]:IQMag:SLOPe?
Example	TRIG:IQM:SLOP POS
Key Path	Trigger, Baseband I/Q, I/Q Mag
Preset	POSitive
State Saved	Saved in instrument state.
Instrument S/W Revision	Prior to A.02.00

Trig Delay Controls a time delay during which the analyzer will wait to begin a sweep after meeting the trigger criteria. You can use negative delay to pre-trigger the instrument in time domain or FFT.

Remote Command	:TRIGger[:SEquence]:IQMag:DELAy <time> :TRIGger[:SEquence]:IQMag:DELAy? :TRIGger[:SEquence]:IQMag:DELAy:STATe OFF ON 0 1 :TRIGger[:SEquence]:IQMag:DELAy:STATe?
Example	TRIG:IQM:DEL 10 ms TRIG:IQM:DEL:STAT ON
Key Path	Trigger, Baseband I/Q, I/Q Mag

Trigger

Preset	1 us OFF
State Saved	Saved in instrument state.
Range	-2.5 s to +10 s
Instrument S/W Revision	Prior to A.02.00

I (Demodulated)

Pressing this key, when it is not selected, selects the main receiver's output I voltage as the trigger. The I (Demodulated) trigger condition is met when the I voltage crosses the I voltage trigger level.

Example	TRIG:<meas>:SOUR IDEM
Key Path	Trigger, Baseband I/Q
Readback Text	I
Instrument S/W Revision	Prior to A.02.00

Trigger Level Sets a level for the I (Demodulated) trigger. When the signal crosses this level, with the chosen slope, the trigger occurs. If the specific Measurement displays the signal from the chosen sampling point a green line will be displayed to indicate the trigger level.

Remote Command	:TRIGger[:SEQuence]:IDEMod:LEVel <voltage> :TRIGger[:SEQuence]:IDEMod:LEVel?
Example	TRIG:IDEM:LEV 0.5 V
Key Path	Trigger, Baseband I/Q, I (Demodulated)
Preset	0.25 V
State Saved	Saved in instrument state.
Range	-1 to 1 V
Readback Text	0.1 of displayed unit (V, mV, etc.)
Instrument S/W Revision	Prior to A.02.00

Trig Slope Controls the trigger polarity. It is set positive to trigger on a rising edge and negative to trigger on a falling edge.

Remote Command	:TRIGger[:SEQuence]:IDEMod:SLOPe POSitive NEGative :TRIGger[:SEQuence]:IDEMod:SLOPe?
Example	TRIG:IDEM:SLOP POS
Key Path	Trigger, Baseband I/Q, I (Demodulated)
Preset	POSitive

State Saved	Saved in instrument state.
Instrument S/W Revision	Prior to A.02.00

Trig Delay Controls a time delay during which the analyzer will wait to begin a sweep after meeting the trigger criteria. You can use negative delay to pre-trigger the instrument in time domain or FFT.

Remote Command	:TRIGger[:SEquence]:IDEMod:DELay <time> :TRIGger[:SEquence]:IDEMod:DELay? :TRIGger[:SEquence]:IDEMod:DELay:STATe OFF ON 0 1 :TRIGger[:SEquence]:IDEMod:DELay:STATe?
Example	TRIG:IDEM:DEL 10 ms TRIG:IDEM:DEL:STAT ON
Key Path	Trigger, Baseband I/Q, I (Demodulated)
Preset	1 us OFF
State Saved	Saved in instrument state.
Range	-2.5 s to +10 s
Instrument S/W Revision	Prior to A.02.00

Q (Demodulated)

Pressing this key, when it is not selected, selects the main receiver's output Q voltage as the trigger. The Q (Demodulated) trigger condition is met when the Q voltage crosses the Q voltage trigger level.

Example	TRIG:<meas>:SOUR QDEM
Key Path	Trigger, Baseband I/Q
Readback Text	Q
Instrument S/W Revision	Prior to A.02.00

Trigger Level Sets a level for the Q (Demodulated) trigger. When the signal crosses this level, with the chosen slope, the trigger occurs. If the specific Measurement displays the signal from the chosen sampling point a green line will be displayed to indicate the trigger level.

Remote Command	:TRIGger[:SEquence]:QDEMod:LEVel <voltage> :TRIGger[:SEquence]:QDEMod:LEVel?
Example	TRIG:QDEM:LEV 0.5 V
Key Path	Trigger, Baseband I/Q, Q (Demodulated)
Preset	0.25 V

Trigger

State Saved	Saved in instrument state.
Range	-1 to 1 V
Readback Text	0.1 of displayed unit (V, mV, etc.)
Instrument S/W Revision	Prior to A.02.00

Trig Slope Controls the trigger polarity. It is set positive to trigger on a rising edge and negative to trigger on a falling edge.

Remote Command	:TRIGger[:SEQuence]:QDEMod:SLOPe POSitive NEGative :TRIGger[:SEQuence]:QDEMod:SLOPe?
Example	TRIG:QDEM:SLOP POS
Key Path	Trigger, Baseband I/Q, Q (Demodulated)
Preset	POSitive
State Saved	Saved in instrument state.
Instrument S/W Revision	Prior to A.02.00

Trig Delay Controls a time delay during which the analyzer will wait to begin a sweep after meeting the trigger criteria. You can use negative delay to pre-trigger the instrument in time domain or FFT.

Remote Command	:TRIGger[:SEQuence]:QDEMod:DELay <time> :TRIGger[:SEQuence]:QDEMod:DELay? :TRIGger[:SEQuence]:QDEMod:DELay:STATe OFF ON 0 1 :TRIGger[:SEQuence]:QDEMod:DELay:STATe?
Example	TRIG:QDEM:DEL 10 ms TRIG:QDEM:DEL:STAT ON
Key Path	Trigger, Baseband I/Q, Q (Demodulated)
Preset	1 us OFF
State Saved	Saved in instrument state.
Range	-2.5 s to +10 s
Instrument S/W Revision	Prior to A.02.00

Input I

Pressing this key, when it is not selected, selects the I channel's ADC voltage as the trigger. The Input I trigger condition is met when the voltage crosses the trigger level.

Example	TRIG:<meas>:SOUR IINP
---------	-----------------------

Key Path	Trigger, Baseband I/Q
Readback Text	Input I
Instrument S/W Revision	Prior to A.02.00

Trigger Level Sets a level for the Input I trigger. When the signal crosses this level, with the chosen slope, the trigger occurs.

Remote Command	:TRIGger[:SEquence]:IINPut:LEVel <voltage> :TRIGger[:SEquence]:IINPut:LEVel?
-----------------------	---

Example TRIG:IINP:LEV 0.5 V

Key Path	Trigger, Baseband I/Q, Input I
Preset	0.25 V
State Saved	Saved in instrument state.
Range	-1 to 1 V
Readback Text	0.1 of displayed unit (V, mV, etc.)
Instrument S/W Revision	Prior to A.02.00

Trig Slope Controls the trigger polarity. It is set positive to trigger on a rising edge and negative to trigger on a falling edge.

Remote Command	:TRIGger[:SEquence]:IINPut:SLOPe POSitive NEGative :TRIGger[:SEquence]:IINPut:SLOPe?
-----------------------	---

Example TRIG:IINP:SLOP POS

Key Path	Trigger, Baseband I/Q, Input I
Preset	POSitive
State Saved	Saved in instrument state.
Instrument S/W Revision	Prior to A.02.00

Trig Delay Controls a time delay during which the analyzer will wait to begin a sweep after meeting the trigger criteria. You can use negative delay to pre-trigger the instrument in time domain or FFT.

Remote Command	:TRIGger[:SEquence]:IINPut:DELay <time> :TRIGger[:SEquence]:IINPut:DELay? :TRIGger[:SEquence]:IINPut:DELay:STATe OFF ON 0 1 :TRIGger[:SEquence]:IINPut:DELay:STATe?
-----------------------	--

Example TRIG:IINP:DEL 10 ms
TRIG:IINP:DEL:STAT ON

Trigger

Key Path	Trigger, Baseband I/Q, Input I
Preset	1 us OFF
State Saved	Saved in instrument state.
Range	-2.5 s to +10 s
Instrument S/W Revision	Prior to A.02.00

Input Q

Pressing this key, when it is not selected, selects the Q channel's ADC voltage as the trigger. The Input Q trigger condition is met when the voltage crosses the trigger level.

Example	TRIG:<meas>:SOUR QINP
Key Path	Trigger, Baseband I/Q
Readback Text	Input Q
Instrument S/W Revision	Prior to A.02.00

Trigger Level Sets a level for the Input Q trigger. When the signal crosses this level, with the chosen slope, the trigger occurs.

Remote Command	:TRIGger[:SEquence]:QINPut:LEVel <voltage> :TRIGger[:SEquence]:QINPut:LEVel?
Example	TRIG:QINP:LEV 0.5 V
Key Path	Trigger, Baseband I/Q, Input Q
Preset	0.25 V
State Saved	Saved in instrument state.
Range	-1 to 1 V
Readback Text	0.1 of displayed unit (V, mV, etc.)
Instrument S/W Revision	Prior to A.02.00

Trig Slope Controls the trigger polarity. It is set positive to trigger on a rising edge and negative to trigger on a falling edge.

Remote Command	:TRIGger[:SEquence]:QINPut:SLOPe Positive NEGative :TRIGger[:SEquence]:QINPut:SLOPe?
Example	TRIG:QINP:SLOP POS
Key Path	Trigger, Baseband I/Q, Input Q

Preset	POSitive
State Saved	Saved in instrument state.
Instrument S/W Revision	Prior to A.02.00

Trig Delay Controls a time delay during which the analyzer will wait to begin a sweep after meeting the trigger criteria. You can use negative delay to pre-trigger the instrument in time domain or FFT.

Remote Command	:TRIGger[:SEquence]:QINPut:DELay <time> :TRIGger[:SEquence]:QINPut:DELay? :TRIGger[:SEquence]:QINPut:DELay:STATe OFF ON 0 1 :TRIGger[:SEquence]:QINPut:DELay:STATe?
-----------------------	--

Example	TRIG:QINP:DEL 10 ms TRIG:QINP:DEL:STAT ON
---------	--

Key Path **Trigger, Baseband I/Q, Input Q**

Preset	1 us OFF
State Saved	Saved in instrument state.
Range	-2.5 s to +10 s
Instrument S/W Revision	Prior to A.02.00

Auxiliary Channel I/Q Mag

Pressing this key, when it is not selected, selects the Auxiliary Channel I/Q magnitude signal as the trigger. The Auxiliary Channel I/Q Magnitude trigger condition is met when the auxiliary receiver's I/Q magnitude output crosses the Auxiliary I/Q magnitude trigger level.

Example	TRIG:<meas>:SOUR AIQM
Key Path	Trigger, Baseband I/Q
Readback Text	Aux I/Q Mag
Instrument S/W Revision	Prior to A.02.00

Trigger Level Sets a level for the I/Q magnitude trigger. When the signal crosses this level, with the chosen slope, the trigger occurs.

Remote Command	:TRIGger[:SEquence]:AIQMag:LEVel <ampl > :TRIGger[:SEquence]:AIQMag:LEVel?
Remote Command Notes	The I/Q reference impedance is used for converting between power and voltage.

Trigger

Example	TRIG:AIQM:LEV -30 dBm
Key Path	Trigger, Baseband I/Q, Aux Channel I/Q Mag
Preset	-25 dBm
State Saved	Saved in instrument state.
Range	-200 dBm to 100 dBm
Readback Text	<level> dBm
Instrument S/W Revision	Prior to A.02.00

Trig Slope Controls the trigger polarity. It is set positive to trigger on a rising edge and negative to trigger on a falling edge.

Remote Command	:TRIGger[:SEquence]:AIQMag:SLOPe POSitive NEGative :TRIGger[:SEquence]:AIQMag:SLOPe?
Example	TRIG:AIQM:SLOP POS
Key Path	Trigger, Baseband I/Q, Aux Channel I/Q Mag
Preset	POSitive
State Saved	Saved in instrument state.
Instrument S/W Revision	Prior to A.02.00

Trig Delay Controls a time delay during which the analyzer will wait to begin a sweep after meeting the trigger criteria. You can use negative delay to pre-trigger the instrument in time domain or FFT.

Remote Command	:TRIGger[:SEquence]:AIQMag:DELay <time> :TRIGger[:SEquence]:AIQMag:DELay? :TRIGger[:SEquence]:AIQMag:DELay:STATe OFF ON 0 1 :TRIGger[:SEquence]:AIQMag:DELay:STATe?
Example	TRIG:AIQM:DEL 10 ms TRIG:AIQM:DEL:STAT ON
Key Path	Trigger, Baseband I/Q, Aux Channel I/Q Mag
Preset	1 us OFF
State Saved	Saved in instrument state.
Range	-2.5 s to +10 s
Instrument S/W Revision	Prior to A.02.00

Trigger Center Frequency This key sets the center frequency to be used by the auxiliary receiver.

Remote Command	:TRIGger[:SEquence]:AIQMag:CENTer <freq> :TRIGger[:SEquence]:AIQMag:CENTer?
Restriction and Notes	Trigger CF + 1/2 Trigger BW < Max Trigger CF – 1/2 Trigger BW > Min
Example	:TRIG:AIQM:CENT 10 MHz
Key Path	Trigger, Baseband I/Q, Aux Channel I/Q Mag
Preset	0 Hz
State Saved	Saved in instrument state.
Range	–40 MHz to 40 MHz
Instrument S/W Revision	Prior to A.02.00

Trigger Bandwidth This key sets the information bandwidth used by the auxiliary receiver for the Auxiliary Channel I/Q Magnitude trigger.

Remote Command	:TRIGger[:SEquence]:AIQMag:BANDwidth <freq> :TRIGger[:SEquence]:AIQMag:BANDwidth?
Restriction and Notes	The combined sample rate for the main and auxiliary receivers cannot exceed 100 MSa/sec. The bandwidth available to the Trigger BW is limited to what is available after the main receiver's bandwidth (Info BW, sometimes pre-FFT BW) is set. Because of this limitation, the Max is not always achievable. The combination of Trigger Center Freq and Trigger BW is also limited: Trigger CF + 1/2 Trigger BW < Max Trigger CF – 1/2 Trigger BW > Min
Example	:TRIG:AIQM:BAND 8 MHz
Key Path	Trigger, Baseband I/Q, Aux Channel I/Q Mag
Preset	Bandwidth option dependent: No Opt: 10 MHz Opt B25: 25 MHz Opt S40: 40 MHz
State Saved	Saved in instrument state.
Range	10 Hz to Maximum
Instrument S/W Revision	Prior to A.02.00

Trigger

Auto/Holdoff

Opens up a menu that lets you adjust Auto Trigger and Trigger Holdoff parameters

Key Path	Trigger
Readback line	Displays a summary of the Auto Trig and Holdoff settings, in square brackets First line: Auto Off or Auto On Second Line: "Hldf" followed by: <ul style="list-style-type: none">• If Holdoff is Off, readback Off• If Holdoff On and Type = Normal, readback value• If Holdoff On and Type = Above, readback value followed by AL• If Holdoff On and Type = Below, readback value followed by BL• If Holdoff Type selection is not supported by the current measurement, Holdoff Type is always Normal
Instrument S/W Revision	A.02.00

Auto Trig

Sets the time that the analyzer will wait for the trigger conditions to be met. If they are not met after that much time, then the analyzer is triggered anyway.

Remote Command:	:TRIGger[:SEquence]:ATRigger <time> :TRIGger[:SEquence]:ATRigger? :TRIGger[:SEquence]:ATRigger:STATe OFF ON 0 1 :TRIGger[:SEquence]:ATRigger:STATe?
Example:	TRIG:ATR:STAT ON TRIG:ATR 100 ms
Preset:	Off, 100 ms
State Saved:	Saved in instrument state.
Min:	1 ms
Max:	100 s
Key Path:	Trigger, Auto/Holdoff
Default Unit:	s
Instrument S/W Revision:	Prior to A.02.00

Trig Holdoff

Sets the holdoff time between triggers. When the trigger condition is satisfied, the trigger occurs, the delay begins, and the holdoff time begins. New trigger conditions will be ignored until the holdoff time

expires. For a free-running trigger, the holdoff value is the minimum time between triggers.

Remote Command:	:TRIGger[:SEQuence]:HOLDoff <time> :TRIGger[:SEQuence]:HOLDoff? :TRIGger[:SEQuence]:HOLDoff:STATe OFF ON 0 1 :TRIGger[:SEQuence]:HOLDoff:STATe?
Example:	TRIG:HOLD:STAT ON TRIG:HOLD 100 ms
Preset:	Off, 100 ms
State Saved:	Saved in instrument state.
Min:	0 s
Max:	0.5 s
Key Path:	Trigger, Auto/Holdoff
Default Unit:	s
Instrument S/W Revision:	Prior to A.02.00

Holdoff Type

Lets you set the Trigger Holdoff Type.

NOTE	Holdoff Type is not supported by all measurements. If the current measurement does not support it, this key will be blank and the Holdoff Type will be Normal. If the Holdoff Type SCPI is sent while in such a measurement, the SCPI will be accepted and the setting remembered, but it will have no effect until a measurement is in force that supports Holdoff Type.
-------------	---

Trigger Holdoff Type functionality:

NORMAL

This is the “oscilloscope” type of trigger holdoff, and is the setting when the Holdoff Type key does not appear. In this type of holdoff, no new trigger will be accepted until the holdoff interval has expired after the previous trigger.

ABOVE

If the trigger slope is positive, a trigger event is generated only if the signal characteristic of interest crosses the trigger threshold (with positive slope) and then remains above the threshold for at least the holdoff time. For negative slope, the trigger event is generated if the signal characteristic crosses the threshold (with negative slope) after having been above the threshold for at least the holdoff time. In either case, the trigger event is associated with the time the level was crossed.

BELow

If the trigger slope is positive, a trigger event is generated only if the signal characteristic of interest crosses the trigger threshold (with positive slope) after having been below the threshold for at least the

Trigger

holdoff time. For negative slope, the trigger event is generated if the signal characteristic crosses the threshold (with negative slope) and then remains below the threshold for at least the holdoff time. In either case, the trigger event is associated with the time the level was crossed.

Remote Command:	:TRIGger[:SEquence]:HOLDoff:TYPE NORMal ABOVE BELOW :TRIGger[:SEquence]:HOLDoff:TYPE?
Example:	TRIG:HOLD:TYPE NORM
Mode:	GSM/EDGE
Preset:	All modes but GSM/EDGE: Normal GSM/EDGE: Below
State Saved:	Saved in instrument state.
Key Path:	Trigger, Auto/Holdoff
Instrument S/W Revision:	A.02.00

Trigger Offset (Remote Command Only)

ESA Backwards Compatibility command

Remote Command:	:TRIGger[:SEquence]:OFFSet <time> :TRIGger[:SEquence]:OFFSet? :TRIGger[:SEquence]:OFFSet:STATe OFF ON 0 1 :TRIGger[:SEquence]:OFFSet:STATe?
Example:	TRIG:OFFS ON TRIG:OFFS -100 ms
Remote Command Notes:	These are ESA commands for trigger offset that allowed you to use a positive or negative delay when in zero span and in a Res BW \geq 1 kHz. For ESA compatibility, X-series analyzers keep track of this offset and add it to the Trigger Delay for line, video or external whenever the value is sent to the hardware, if in Zero Span and RBW \geq 1 kHz.
Preset:	Off, 0 s
State Saved:	Saved in instrument state.
Min:	-11 s
Max:	+11 s
Instrument S/W Revision:	Prior to A.02.00

View/Display

The View/Display key opens up the View menu for the current measurement. This menu includes the **Display** key for controlling items on the display. The Display functions are common across multiple Modes and Measurements and are described in this section. See each measurement description for information on data views that are unique to that Measurement.

Views are different ways of looking at data, usually different ways of looking at the same data, especially when the data represents a time record that is being digitally processed with an FFT and/or other digital signal processing algorithms. In some modes, like the Spectrum Analyzer mode, we are mostly concerned with swept spectrum analysis, and those views may represent different ways of looking at the same signal.

Key Path	Front-panel key
Instrument S/W Revision	Prior to A.02.00

Display

The **Display** menu is common to most measurements, and is used for configuring items on the display. Some **Display** menu settings apply to all the measurements in a mode, and some only to the current measurement. Those under the **System Display Settings** key apply to all measurements in all modes.

Key Path	View/Display
Instrument S/W Revision	Prior to A.02.00

Annotation

Turns on/off various parts of the display annotation. The annotation is divided up into four categories:

1. Meas Bar: This is the measurement bar at the top of the screen. It does not include the settings panel or the Active Function. Turning off the Meas Bar turns off the settings panel and the Active Function. When the Meas Bar is off, the graticule area expands to fill the area formerly occupied by the Meas Bar.
2. Screen Annotation: this is the annotation and annunciation around the graticule, including any annotation on lines (such as the display line, the threshold line, etc.) This does NOT include the marker number or the N dB result. When off, the graticule expands to fill the entire graticule area.
3. Trace annotation: these are the labels on the traces, showing their detector (or their math mode).
4. Active Function annotation: this is the active function display in the meas bar, and all of the active function values displayed on keys.

See figure below. Each type of annotation can be turned on and off individually.

View/Display

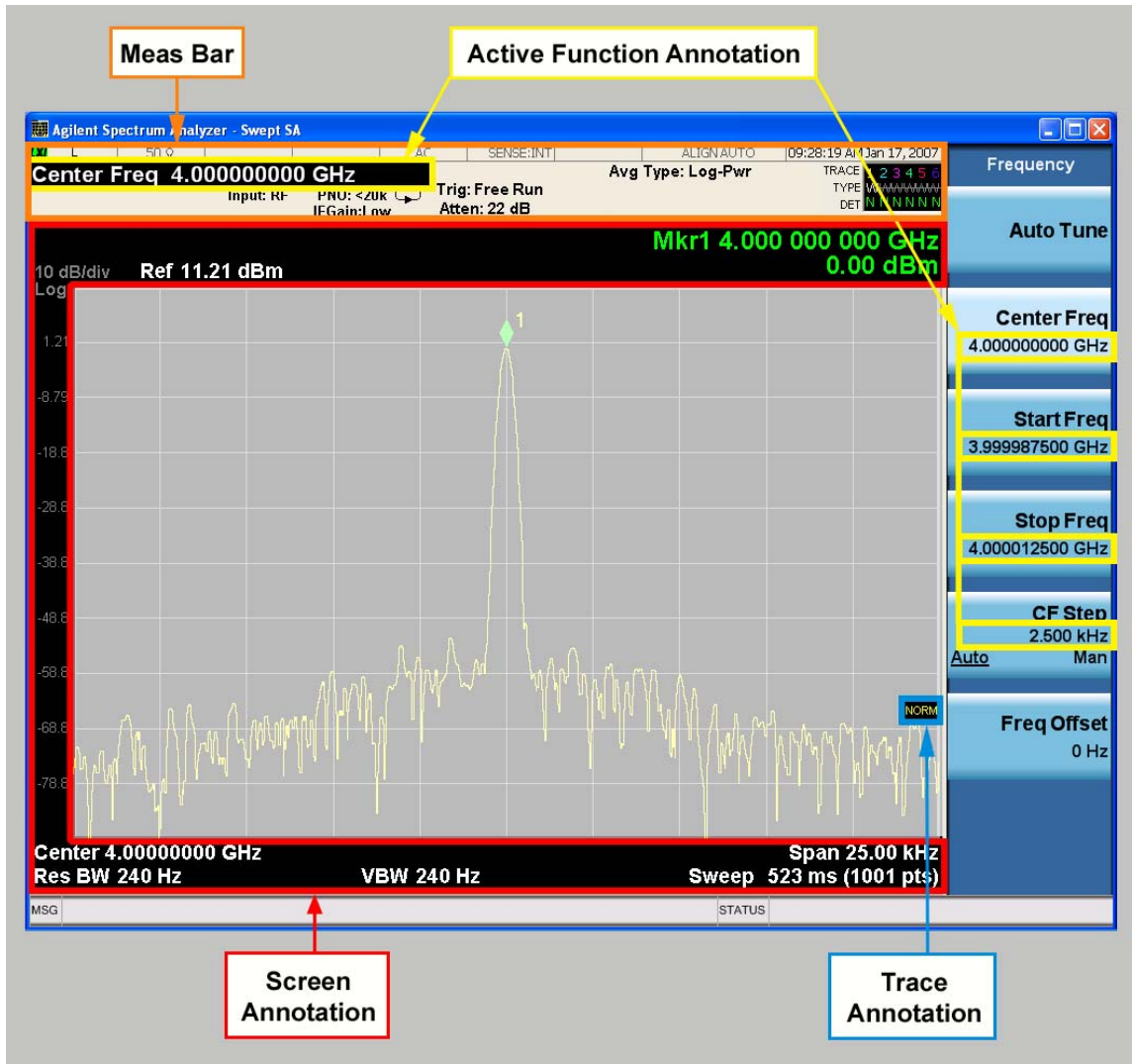

Key Path **View/Display, Display**

Instrument S/W Revision Prior to A.02.00

Meas Bar On/Off This function turns the Measurement Bar on and off, including the settings panel. When off, the graticule area expands to fill the area formerly occupied by the Measurement Bar.

Remote Command: `:DISPlay:ANNotation:MBAR[:STATe] OFF|ON|0|1`
`:DISPlay:ANNotation:MBAR[:STATe]?`

Example: `DISP:ANN:MBAR OFF`

Dependencies/Couplings: Grayed out and forced to OFF when **System Display Settings, Annotation** is set to Off.

Preset:	On This should remain Off through a Preset when System Display Settings, Annotation is set to Off.
State Saved:	Saved in instrument state.
Key Path:	View/Display, Display, Annotation
Instrument S/W Revision:	Prior to A.02.00

Screen This controls the display of the annunciation and annotation around the graticule, including any annotation on lines (such as the display line, the threshold line, etc.) and the y-axis annotation. This does NOT include marker annotation (or the N dB result). When off, the graticule expands to fill the entire graticule area, leaving only the 1.5% gap above the graticule as described in the Trace/Detector chapter.

Remote Command:	:DISPlay:ANNOtation:SCREen[:STATe] OFF ON 0 1 :DISPlay:ANNOtation:SCREen[:STATe]?
Example:	DISP:ANN:SCR OFF
Dependencies/Couplings:	Grayed out and forced to OFF when System Display Settings, Annotation is set to Off.
Preset:	On This should remain Off through a Preset when System Display Settings, Annotation is set to Off
State Saved:	Saved in instrument state.
Key Path:	View/Display, Display, Annotation
Instrument S/W Revision:	Prior to A.02.00

Trace Turns on and off the labels on the traces, showing their detector (or their math mode) as described in the Trace/Detector section.

If trace math is being performed with a trace, then the trace math annotation will replace the detector annotation.

Remote Command:	:DISPlay:ANNOtation:TRACe[:STATe] ON OFF 1 0 :DISPlay:ANNOtation:TRACe[:STATe]?
Example:	DISP:ANN:TRAC OFF
Preset:	Off
State Saved:	Saved in instrument state.
Key Path:	View/Display, Display, Annotation
Instrument S/W Revision:	Prior to A.02.00

Active Function Values On/Off Turns on/off the active function display in the Meas Bar, and all of the

View/Display

active function values displayed on the keys.

Note that all of the keys that have active functions have these numeric values blanked when this function is on. This is a security feature.

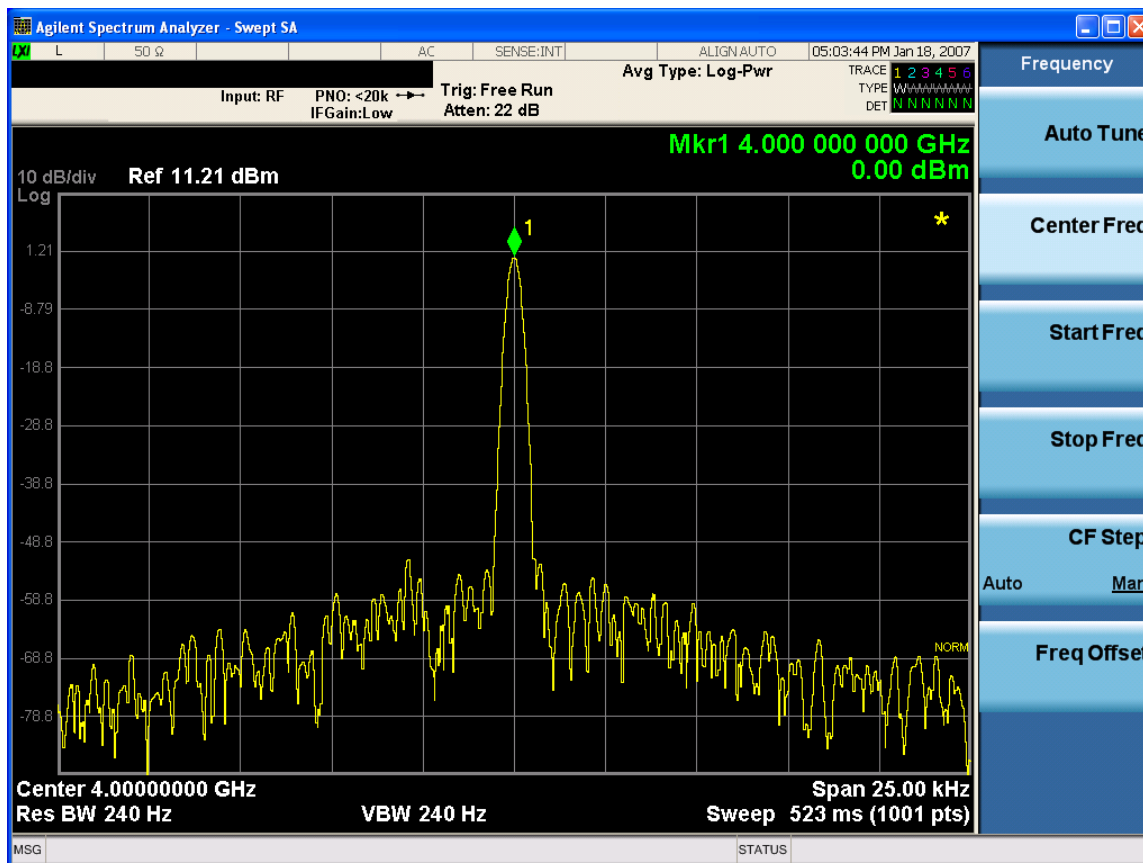

Remote Command: :DISPlay:ACTivefunc[:STATe] ON|OFF|1|0
 :DISPlay:ACTivefunc[:STATe]?

Example: DISP:ACT OFF

Dependencies/Couplings: Grayed out and forced to OFF when **System Display Settings, Annotation** is set to Off.

Preset: On
 This should remain Off through a Preset when **System Display Settings, Annotation** is set to Off

State Saved: Saved in instrument state.

Key Path: **View/Display, Display, Annotation**

Instrument S/W Revision: Prior to A.02.00

Title

Displays menu keys that enable you to change or clear a title on your display.

Key Path **View/Display, Display**

Instrument S/W Revision Prior to A.02.00

Change Title Writes a title into the "measurement name" field in the banner, for example, "Swept SA".

Press Change Title to enter a new title through the alpha editor. Press Enter or Return to complete the entry. Press ESC to cancel the entry and preserve your existing title.

The display title will replace the measurement name. It remains for this measurement until you press **Change Title** again, or you recall a state, or a Preset is performed. A title can also be cleared by pressing **Title, Clear Title**.

NOTE Notice the inclusion of the <measurement> parameter in the command below. Because each measurement remembers the Display Title, the command must be qualified with the measurement name. For the Swept SA measurement this is not the case; for backwards compatibility, no <measurement> parameter is used when changing the Display Title for the Swept SA measurement.

Remote Command :DISPlay:<measurement>:ANNotation:TITLe:DATA <string>
:DISPlay:<measurement>:ANNotation:TITLe:DATA?

Example DISP:ANN:TITL:DATA "This Is My Title"

This example is for the Swept SA measurement in the Spectrum Analyzer mode. The SANalyzer <measurement> name is not used.

DISP:ACP:ANN:TITL:DATA "This Is My Title"

This example is for Measurements other than Swept SA.

Both set the title to: This Is My Title

Key Path **View/Display, Display, Title**

Mode All

Preset No title (measurement name instead)

State Saved Saved in instrument state.

Instrument S/W Revision Prior to A.02.00

Clear Title Clears a title from the front-panel display. Once cleared, the title cannot be retrieved. After the title is cleared, the current Measurement Name replaces it in the title bar.

Example: DISP:ANN:TITL:DATA "" clears any existing title characters.

View/Display

Remote Command Notes:	Use the :DISPlay:ANNOtation:TITLe:DATA <string> command with an empty string.
Preset:	Performed on Preset.
Key Path:	View/Display, Display, Title
Instrument S/W Revision:	Prior to A.02.00

Graticule

Pressing Graticule turns the display graticule On or Off. It also turns the graticule y-axis annotation on and off.

Remote Command:	:DISPlay:WINDow[1]:TRACe:GRATicule:GRID[:STATE] OFF ON 0 1 :DISPlay:WINDow[1]:TRACe:GRATicule:GRID[:STATE]?
Example:	DISP:WIND:TRAC:GRAT:GRID OFF
Preset:	On
State Saved:	saved in instrument state
Key Path:	View/Display, Display
Instrument S/W Revision:	Prior to A.02.00

Display Line

Activates an adjustable horizontal line that is used as a visual reference line. The line's vertical position corresponds to its amplitude value. The value of the display line (for example, "-20.3 dBm") appears above the line itself on the right side of the display in the appropriate font.

The display line can be adjusted using the step keys, knob, or numeric keypad. The unit of the Display Line is determined by the **Y axis unit** setting under **Amplitude**. If more than one window has a display line, the display line of the selected window is controlled.

If the display line is off the screen, it shows as a line at the top/bottom of the screen with an arrow pointing up or down. As with all such lines (Pk Thresh, Trigger Level, etc.) it is drawn on top of all traces.

The display line is unaffected by Auto Couple.

Remote Command:	:DISPlay:WINDow[1]:TRACe:Y:DLINe <amp;l> :DISPlay:WINDow[1]:TRACe:Y:DLINe? :DISPlay:WINDow[1]:TRACe:Y:DLINe:STATe OFF ON 0 1 :DISPlay:WINDow[1]:TRACe:Y:DLINe:STATe?
Example:	DISP:WIND:TRAC:Y:DLIN:STAT ON DISP:WIND:TRAC:Y:DLIN:STAT -32 dBm

Preset:	Set the Display Line to Off and –25 dBm on Preset. When the Display Line goes from Off to On, if it is off screen, set it to either the top or bottom of screen, depending on which direction off screen it was. The Display Line's value does not change when it is turned off.
State Saved:	Saved in instrument state.
Min:	– (minus infinity) in current units
Max:	+ (plus infinity) in current units
Key Path:	View/Display, Display
Default Unit:	Depends on the current selected Y axis unit
Instrument S/W Revision:	Prior to A.02.00

System Display Settings

These settings are "Mode Global" – they affect all modes and measurements and are reset only by **Restore Misc Defaults** or **Restore System Defaults** under System.

Key Path	View/Display, Display, System Display Settings
Instrument S/W Revision	Prior to A.02.00

Annotation Local Settings/All Off This is a Mode Global override of the meas local annotation settings. When it is **All Off**, it forces **Screen Annotation, Meas Bar, Trace, and Active Function Values** settings to be **OFF** for all measurements in all modes. This provides the security based "annotation off" function of previous analyzers; hence it uses the legacy SCPI command.

When it is **All Off, Screen, Meas Bar, Trace, and Active Function Values** keys under the **Display, Annotation** menu are grayed out and forced to **Off**. When **Local Settings** has been selected, you are able to set the local annotation settings on a measurement by measurement basis.

Remote Command:	:DISPlay:WINDow[1]:ANNotation[:ALL] OFF ON 0 1 :DISPlay:WINDow[1]:ANNotation[:ALL]?
Example:	:DISP:WIND:ANN OFF
Preset:	On (Set by Restore Misc Defaults)
State Saved:	Not saved in instrument state.
Key Path:	View/Display, Display, System Display Settings, Annotation
Instrument S/W Revision:	Prior to A.02.00

Theme This key allows you to change the Display theme. This is similar to the Themes selection under

View/Display

Page Setup and Save Screen Image. The four themes are detailed below.

Remote Command:	<code>:DISPlay:THEME TDColor TDMonochrome FCOLor FMONochrome</code> <code>:DISPlay:THEME?</code>
Preset:	TDColor (Set by Restore Misc Defaults)
State Saved:	Not saved in instrument state.
Key Path:	View/Display, Display, System Display Settings
Remote Command Notes:	TDColor – 3D is the standard color theme with filling and shading TDMonochrome – is similar to 3D color, but only black is used FCOLor – flat color is intended for inkjet printers to conserve ink. It uses a white background instead of black. FMONochrome – is like flat color, but only black is used
Example:	DISP:THEM TDM sets the display theme to 3D Monochrome.
Instrument S/W Revision:	Prior to A.02.00

Backlight Accesses the display backlight on/off keys. This setting may interact with settings under the Windows "Power" menu.

When the backlight is off, pressing ESC, TAB, SPACE, ENTER, UP, DOWN, LEFT, RIGHT, DEL, BKSP, CTRL, or ALT turns the backlight on without affecting the application. Pressing any other key will turn backlight on and could potentially perform the action as well.

Remote Command:	<code>:DISPlay:BACKlight ON OFF</code> <code>:DISPlay:BACKlight?</code>
Preset:	ON (Set by Restore Misc Defaults)
Key Path:	View/Display, Display, System Display Settings
Instrument S/W Revision:	Prior to A.02.00

On Turns the display backlight on.

Example:	DISP:BACK ON
Key Path:	View/Display, Display, System Display Settings, Backlight
Readback:	On
Instrument S/W Revision:	Prior to A.02.00

Off Turns the display backlight off.

Example:	DISP:BACK OFF
Key Path:	View/Display, Display, System Display Settings, Backlight

Readback: Off
 Instrument S/W Revision: Prior to A.02.00

Backlight Intensity An active function used to set the backlight intensity. It goes from 0 to 100 where 100 is full on and 0 is off. This value is independent of the values set under the Backlight on/off key.

Remote Command: :DISPlay:BACKlight:INTensity <integer>
 :DISPlay:BACKlight:INTensity?
 Example: DISP:BACK:INT 50
 Preset: 100 (Set by Restore Misc Defaults)
 Min: 0
 Max: 100
 Key Path: **View/Display, Display, System Display Settings**
 Instrument S/W Revision: Prior to A.02.00

Full Screen

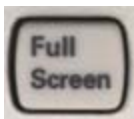

When **Full Screen** is pressed the measurement window expands horizontally over the entire instrument display. The screen graticule area expands to fill the available display area.

It turns off the display of the key labels, however the menus and active functions still work. (Though it would obviously be very hard to navigate without the key labels displayed.) Pressing **Full Screen** again while Full Screen is in effect cancels Full Screen.

Note that the banner and status lines are unaffected. You can get even more screen area for your data display by turning off the Meas Bar (in the Display menu) which also turns off the settings panel.

Full Screen is a Meas Global function. Therefore it is cancelled by the **Preset** key.

Remote Command: :DISPlay:FSCreen[:STATe] OFF|ON|0|1
 :DISPlay:FSCreen[:STATe]?
 Preset: Off
 State Saved: Not saved in state.
 Key Path: **Display**
 Instrument S/W Revision: Prior to A.02.00

Display Enable (Remote Command Only)

Turns the display on/off, including the display drive circuitry. The backlight stays lit so you can tell that the instrument is on. The display enable setting is mode global. The reasons for turning the display off are three:

- To increase speed as much as possible by freeing the instrument from having to update the display
- To reduce emissions from the display, drive circuitry
- For security purposes

If you have turned off the display:

- and you are in local operation, the display can be turned back on by pressing any key or by sending the `SYSTem:DEFaults MISC` command or the `DISPlay:ENABle ON` (neither `*RST` nor `SYSTem:PRESet` enable the display.)
- and you are in remote operation, the display can be turned back on by pressing the **Local** or **Esc** keys or by sending the `SYSTem:DEFaults MISC` command or the `DISPlay:ENABle ON` (neither `*RST` nor `SYSTem:PRESet` enable the display.)

and you are using either the `SYSTem:KLOCK` command or GPIB local lockout, then no front-panel key press will turn the display back on. You must turn it back on remotely.

Remote Command:	<code>:DISPlay:ENABle OFF ON 0 1</code> <code>:DISPlay:ENABle?</code>
Example:	<code>DISP:ENAB OFF</code>
Dependencies/Couplings:	<code>DISP:ENAB OFF</code> turns Backlight OFF and <code>DISP:ENAB ON</code> turns Backlight ON. However, settings of Backlight do not change the state of <code>DISP:ENAB</code>
Preset:	On Set by <code>SYST:DEF MISC</code> , but Not affected by <code>*RST</code> or <code>SYSTem:PRESet</code> .
State Saved:	Not saved in instrument state.
Instrument S/W Revision:	Prior to A.02.00